

FontanaArte

FontanaArte

MILANO 1932



# FontanaArte

MILANO 1932

LISTINO / PRICE LIST 2023





FontanaArte nasce a Milano nel 1932 dall'incontro di Gio Ponti, grande padre dell'architettura italiana del Novecento, con Luigi Fontana, imprenditore del vetro in lastra, e Pietro Chiesa, maestro nell'arte vetraria. FontanaArte accompagna l'esplorazione della modernità italiana per cui vetro e metallo sono l'espressione di una nuova idea di bellezza profusa di luce e trasparenze. La sua storia è segnata dalla produzione di lampade e ogni tipo di soluzione che porta la luce nello spazio abitato, una missione senza tempo che si tramanda tra icone e nuovi prodotti.

FontanaArte was founded in Milan in 1932, originating in an encounter between Gio Ponti (the great 20th-century maestro of Italian architecture), Luigi Fontana (entrepreneur of sheet glass) and Pietro Chiesa (a master glass artisan). FontanaArte accompanied Italy's exploration of modernity, where glass and metal expressed a new idea of beauty infused with light and transparency. The history of FontanaArte is distinguished by lamps and every type of object that brought light into the inhabited space. This timeless mission has been passed down from icon to new product.

# INDICE / CONTENTS

## **VISUAL INDEX**

p. 7

## **INDICE PER DESIGNER / INDEX BY DESIGNER**

p. 16

## **VISUAL INDEX PER FAMIGLIA / VISUAL INDEX BY FAMILY**

p. 18

## **LAMPADE DA TAVOLO / TABLE LAMPS**

p. 23

## **LAMPADE DA TERRA / FLOOR LAMPS**

p. 49

## **LAMPADE A PARETE / WALL LAMPS**

p. 65

## **LAMPADE A PLAFONE / CEILING LAMPS**

p. 83

## **LAMPADE A SOSPENSIONE / SUSPENSION LAMPS**

p. 93

## **OUTDOOR**

p. 131

## **ARREDO E VASI / FONITURE AND VASES**

p. 137

## **INFORMAZIONI TECNICHE / TECHNICAL NOTES**

p. 145

# LAMPADE DA TAVOLO / TABLE LAMPS



**3247TA**  
Historical Archive  
p. 25



**ASHANGHAI**  
Max Ingrand  
p. 25



**BIANCA**  
Matti Klenell  
p. 26



**BILIA MINI**  
Gio Ponti  
p. 27



**BILIA**  
Gio Ponti  
p. 27



**BIS / TRIS**  
Historical Archive  
p. 28



**BLOM**  
Andreas Engesvik  
p. 28



**CHESHIRE**  
GamFratesi  
p. 29



**DARUMA**  
Sergio Asti  
p. 29



**EQUATORE**  
Gabriele e Oscar Buratti  
p. 30



**FALENA**  
Alvaro Siza  
p. 31



**FONTANA**  
Max Ingrand  
p. 31



**FONTANELLA**  
Federico Peri  
p. 32



**GIOVA**  
Gae Aulenti  
p. 33



**KINX**  
Karim Rashid  
p. 34



**LASOSPESA**  
Stefano Boeri Architetti  
p. 34



**LOOP**  
Voon Wong & Benson Saw  
p. 34



**MANO**  
Pietro Chiesa  
p. 35



**MATRIX**  
Studio OS Δ OOS  
p. 35



**MERIDIANO**  
Gabriele e Oscar Buratti  
p. 36



**METAFORA**  
Umberto Riva  
p. 36



**NASKA**  
Historical Archive  
p. 37



**OORT SISTEMA**  
Jacopo Roda  
p. 40



**PALLINA**  
FontanaArte Design Lab  
p. 40



**PAROLA**  
Gae Aulenti e Piero Castiglioni  
p. 40



**PASSION**  
Studio Beretta Associati  
p. 41



**PINECONE**  
Paola Navone  
p. 41



**PIRELLINA**  
Gio Ponti  
p. 42



**RE**  
Bobo Piccoli  
p. 42



**REGINA**  
Bobo Piccoli  
p. 43



**SETAREH**  
Francesco Librizzi  
p. 43



**THEA**  
Gabriele e Oscar Buratti  
p. 44



**THOR**  
Pagani Perversi Architects  
p. 45



**TROPICO**  
Gabriele e Oscar Buratti  
p. 45



**UOVO**  
Ben Swildens  
p. 46



**UOVO RIC/REC**  
Ben Swildens  
p. 47



**UOVO OUTDOOR**  
Ben Swildens  
p. 47



**VOLÉE**  
Odo Fioravanti  
p. 48



**DEMI VOLÉE**  
Odo Fioravanti  
p. 48

# LAMPADE DA TERRA / FLOOR LAMPS



**0024**  
Gio Ponti  
p. 51



**3247**  
Historical Archive  
p. 51



**ALICANTO**  
Francesco Librizzi  
p. 52



**BIANCA**  
Matti Klenell  
p. 53



**CHESHIRE**  
GamFratesi  
p. 53



**EQUATORE**  
Gabriele e Oscar Buratti  
p. 54



**FALENA**  
Alvaro Siza  
p. 55



**FLÛTE**  
Franco Raggi  
p. 55



**GALERIE**  
Federico Peri  
p. 56



**LUMEN**  
Historical Archive  
p. 57



**LUMINATOR**  
Pietro Chiesa  
p. 57



**MERIDIANO**  
Gabriele e Oscar Buratti  
p. 58



**NASKA XL**  
Historical Archive  
p. 58



**OORT SISTEMA**  
Jacopo Roda  
p. 59



**PAROLA**  
Gae Aulenti e Piero Castiglioni  
p. 60



**PAROLONA**  
Gae Aulenti e Piero Castiglioni  
p. 60



**PIRELLONE**  
Gio Ponti  
p. 61



**PRIMA SIGNORA**  
Daniela Puppa  
p. 61



**RILUMINATOR**  
Pietro Chiesa  
p. 62



**SCINTILLA**  
Livio e Piero Castiglioni  
p. 62



**THEA**  
Gabriele e Oscar Buratti  
p. 63



**TRIPOD**  
Front Design  
p. 63



**VERTIGO**  
Marco Acerbis  
p. 64



**YUMI**  
Shigeru Ban  
p. 64



# LAMPADE A PARETE / WALL LAMPS



**ALICANTO**  
Francesco Librizzi  
p. 67



**APEX**  
Karim Rashid  
p. 68



**BIANCA**  
Matti Klenell  
p. 68



**BONNET**  
Odo Fioravanti  
p. 69



**BRUCO**  
Vico Magistretti  
p. 69



**FALENA**  
Alvaro Siza  
p. 69



**FLEX**  
Karim Rashid  
p. 70



**FONTANELLA**  
Federico Peri  
p. 70



**FRENESI**  
Studiolucaguadagnino  
p. 71



**GALERIE**  
Federico Peri  
p. 71



**IO**  
Claesson Koivisto Rune  
p. 71



**LUNAIRE**  
Ferréol Babin  
p. 72



**NASKA**  
Historical Archive  
p. 73



**NOBI**  
Metis Lighting  
p. 74



**OORT SISTEMA**  
Jacopo Roda  
p. 75



**PALLINA**  
FontanaArte Design Lab  
p. 75



**PAROLA**  
Gae Aulenti e Piero Castiglioni  
p. 76



**RIGA**  
Paolo Zani  
p. 76



**SCINTILLA**  
Livio e Piero Castiglioni  
p. 77



**SILLABA**  
Piero Castiglioni  
p. 78



**SILLABONE**  
Piero Castiglioni  
p. 79



**SOLE**  
Bernardino Amato  
p. 80



**THEA**  
Gabriele e Oscar Buratti  
p. 80



**TROPICO**  
Gabriele e Oscar Buratti  
p. 81

## LAMPADE A PLAFONE / CEILING LAMPS



**BIANCA**  
Matti Klenell  
p. 85



**FONTANELLA**  
Federico Peri  
p. 86



**FRENESI**  
StudioLucaGuadagnino  
p. 87



**OORT SISTEMA**  
Jacopo Roda  
p. 87



**PALLINA**  
FontanaArte Design Lab  
p. 88



**PANGEN**  
Historical Archive  
p. 89



**SILLABA**  
Piero Castiglioni  
p. 89



**SILLABONE**  
Piero Castiglioni  
p. 90



**SOLE**  
Bernardino Amato  
pag. 90



**THEA**  
Gabriele e Oscar Buratti  
pag. 91



**TROPICO**  
Gabriele e Oscar Buratti  
pag. 92

# LAMPADE A SOSPENSIONE / SUSPENSION LAMPS



**0024**  
Gio Ponti  
p. 95



**0024XXL**  
Gio Ponti  
p. 95



**AMAX**  
Charles Williams  
p. 96



**AVICO**  
Charles Williams  
p. 98



**BIANCA**  
Matti Klenell  
p. 99



**BOLLA**  
Studio Harry-Paul  
p. 100



**CHANDELIER**  
David Chipperfield  
p. 101



**CHESHIRE**  
GamFratesi  
p. 102



**EQUATORE**  
Gabriele e Oscar Buratti  
p. 103



**FONTANELLA**  
Federico Peri  
p. 104



**FLÛTE**  
Franco Raggi  
p. 105



**GLOBO DI LUCE**  
Roberto Menghi  
p. 107



**HUNA**  
Historical Archive  
p. 109



**LAMPARA**  
Historical Archive  
p. 109



**MERIDIANO**  
Gabriele e Oscar Buratti  
p. 110



**OORT SISTEMA**  
Jacopo Roda  
p. 112



**PALLINA**  
FontanaArte Design Lab  
p. 116



**PANGEN**  
Historical Archive  
p. 116



**PAROLA**  
Gae Aulenti e Piero Castiglioni  
p. 117



**PINECONE**  
Paola Navone  
p. 117



**SCINTILLA**  
Livio e Piero Castiglioni  
p. 119



**SERPENTINE**  
Gabi Peretto  
p. 120



**SETAREH**  
Francesco Librizzi  
p. 120



**THEA**  
Gabriele e Oscar Buratti  
p. 125



**TUTTI**  
Matilde Cassani  
p. 126



**UOVO**  
Ben Swildens  
p. 130

## OUTDOOR



**NASKA XL**  
Historical Archive  
p. 133



**OORT**  
Jacopo Roda  
p. 133



**UOVO RIC/REC**  
Ben Swildens  
p. 136



**UOVO OUTDOOR**  
Ben Swildens  
p. 136

# ARREDO E VASI / FURNITURE AND VASES



**FONTANA**  
Pietro Chiesa  
p. 139



**TAVOLINO 1932**  
Gio Ponti  
p. 140



**TAVOLO CON RUOTE**  
Gae Aulenti  
p. 140



**TOUR**  
Gae Aulenti  
p. 142



**TESO**  
Renzo Piano  
p. 143

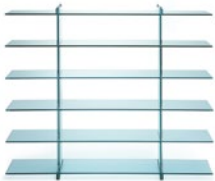

**TESO**  
Renzo Piano  
p. 143



**TESO**  
Renzo Piano  
p. 144



**CARTOCCIO**  
Pietro Chiesa  
p. 144



**CARTOCCIO Q**  
Pietro Chiesa  
p. 144

# INDICE PER DESIGNER / INDEX BY DESIGNER

## **ALVARO SIZA**

FALENA, p. 31, 55, 69

## **ANDREAS ENGESVIK**

BLOM, p. 28

## **BEN SWILDENS**

UOVO, p. 46, 130

UOVO RICARICABILE /  
RECHARGEABLE, p. 47, 136

UOVO OUTDOOR, p. 47, 136

## **BERNARDINO AMATO**

SOLE, p. 80, 90

## **BOBO PICCOLI**

RE, p. 42

REGINA, p. 43

## **CHARLES WILLIAMS**

AMAX, p. 96

AVICO, p. 98

## **CLAESSON KOIVISTO**

### **RUNE**

IO, p. 71

## **DANIELA PUPPA**

PRIMA SIGNORA, p. 61

## **DAVID CHIPPERFIELD**

CHANDELIER, p. 101

## **FEDERICO PERI**

FONTANELLA, p. 32, 70, 86, 104

GALERIE, p. 56, 71

## **FERRÉOL BABIN**

LUNAIRE, p. 72, 87

## **FONTANAARTE DESIGN LAB**

PALLINA, p. 40, 75, 88, 116

## **FRANCESCO LIBRIZZI**

ALICANTO, p. 52, 67

SETAREH, p. 43, 120

## **FRANCO RAGGI**

FLÛTE, p. 55, 105

## **FRONT DESIGN**

TRIPOD, p. 63

## **GABI PERETTO**

SERPENTINE, p. 120

## **GABRIELE E OSCAR BURATTI**

EQUATORE, p. 30, 54, 103

MERIDIANO, p. 36, 58, 110

THEA, p. 44, 63, 80, 91, 125

TROPICO, p. 45, 81, 92

## **GAE AULENTI**

GIOVA, p. 33

PAROLA, p. 40, 60, 76, 117

PAROLONA, p. 60

TAVOLO CON RUOTE, p. 138

TOUR, p. 142

## **GAMFRATESI**

CHESHIRE, p. 29, 53, 102

## **GIO PONTI**

0024, p. 51, 98

BILIA MINI, p. 27

BILIA, p. 27

PIRELLINA, p. 42

PIRELLONE, p. 61

TAVOLINO 1932, p. 140

## **HISTORICAL**

### **ARCHIVE**

3247, p. 25, 51

BIS/TRIS, p. 28

HUNA, p. 109

LAMPARA, p. 109

LUMEN, p. 57

NASKA, p. 37, 73

NASKA XL, p. 58

NASKA XL OUTDOOR, p. 133

PANGEN, p. 87, 116

## **STUDIO HARRY-PAUL**

BOLLA, p. 100

## **JACOPO RODA**

OORT, p. 40, 59, 75, 87, 112

OORT OUTDOOR, p. 133

## **KARIM RASHID**

APEX, p. 68

FLEX, p. 70

KINX, p. 34

## **LIVIO CASTIGLIONI**

SCINTILLA, p. 62, 77, 119

## **MARCO ACERBIS**

VERTIGO, p. 64

## **MATILDE CASSANI**

TUTTI, p. 126

## **MAX INGRAND**

ASHANGHAI, p. 25

FONTANA, p. 31

## **METIS LIGHTING**

NOBI, p. 74

**ODO FIORAVANTI**

BONNET, p. 69

VOLÉE, p. 48

DEMI VOLÉE, p. 48

**STUDIO OS Δ OOS**

MATRIX, p. 35

**PAGANI PERVERSI ARCHITECTS**

THOR, p. 45

**PAOLA NAVONE**

PINECONE, p. 41, 117

**PAOLO ZANI**

RIGA, p. 76

**PIERO CASTIGLIONI**

PAROLA, p. 40, 60, 76, 117

PAROLONA, p. 60

SCINTILLA, p. 62, 77, 119

SILLABA, p. 78, 89

SILLABONE, p. 79, 90

**PIETRO CHIESA**

CARTOCCIO, p. 144

FONTANA TAVOLINO, p. 139

LUMINATOR, p. 57

MANO, p. 35

RILUMINATOR, p. 62

**RENZO PIANO**

TESO, p. 143

**ROBERTO MENGHI**

GLOBO DI LUCE, p. 107

**SERGIO ASTI**

DARUMA, p. 29

**SHIGERU BAN**

YUMI, p. 64

**STEFANO BOERI**

**ARCHITETTI**

LASOSPESA, p. 34

**STUDIO BERETTA**

**ASSOCIATI**

PASSION, p. 41

**STUDIOLUCAGUADAGNINO**

FRENESI, p. 71, 87

**UMBERTO RIVA**

METAFORA, p. 36

**VICO MAGISTRETTI**

BRUCO, p. 69

**VOON WONG**

**& BENSON SAW**

LOOP, p. 34



# VISUAL INDEX PER FAMIGLIA / VISUAL INDEX BY FAMILY

---

**0024**  
GIO PONTI



---

**3247**  
HISTORICAL  
ARCHIVE



---

**ALICANTO**  
FRANCESCO  
LIBRIZZI

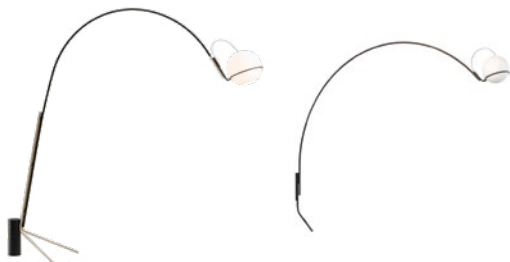

---

**BIANCA**  
MATTI KLENELL



**CHESHIRE**  
GAMFRATESI



**EQUATORE**  
GABRIELE E OSCAR  
BURATTI



**FALENA**  
ALVARO SIZA



**FLÛTE**  
FRANCO RAGGI



**FONTANELLA**  
FEDERICO PERI



**GALERIE**  
FEDERICO PERI



---

**MERIDIANO**  
GABRIELE E OSCAR  
BURATTI



---

**NASKA**  
HISTORICAL  
ARCHIVE



---

**OORT SISTEMA**  
JACOPO RODA



---

**PALLINA**  
FONTANAARTE  
DESIGN LAB



**PANGEN**  
HISTORICAL  
ARCHIVE



---

**PAROLA**  
GAE AULENTI E PIERO  
CASTIGLIONI



---

**PINECONE**  
PAOLA NAVONE



---

**PIRELLI**  
GIO PONTI



---

**SCINTILLA**  
LIVIO E PIERO  
CASTIGLIONI



**SETAREH**  
FRANCESCO  
LIBRIZZI



**THEA**  
GABRIELE E OSCAR  
BURATTI



**TROPICO**  
GABRIELE E OSCAR  
BURATTI



**UOVO**  
BEN SWILDENS



# LAMPADE DA TAVOLO / TABLE LAMPS

3247TA	p. 25	NASKA	p. 37
ASHANGHAI	p. 25	OORT SISTEMA	p. 40
BIANCA	p. 26	PALLINA	p. 40
BILIA MINI	p. 27	PAROLA	p. 40
BILIA	p. 27	PASSION	p. 41
BIS / TRIS	p. 28	PINECONE	p. 41
BLOM	p. 28	PIRELLINA	p. 42
CHESHIRE	p. 29	RE	p. 42
DARUMA	p. 29	REGINA	p. 43
EQUATORE	p. 30	SETAREH	p. 43
FALENA	p. 31	THEA	p. 44
FONTANA	p. 31	THOR	p. 45
FONTANELLA	p. 32	TROPICO	p. 45
GIOVA	p. 33	UOVO	p. 46
KINX	p. 34	UOVO RIC. / REC.	p. 47
LASOSPESA	p. 34	UOVO INDOOR / OUTDOOR	p. 47
LOOP	p. 34	VOLÉE	p. 48
MANO	p. 35	DEMI VOLÉE	p. 48
MATRIX	p. 35		
MERIDIANO	p. 36		
METAFORA	p. 36		





**3247TA**  
**HISTORICAL ARCHIVE**  
 1954

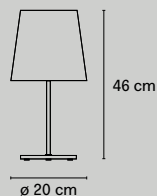

Codice Code	Materiale Material	Colore Colour	Sorgente luminosa Light source	Dimmer incluso Dimmer included	Classe energetica Energy label	Prezzo Retail con IVA Retail Price VAT incl.
F324700150KBNE	Vetro, Metallo Glass, Metal	Nichel, Bianco Nickel, White	1x max 57W E27	Si Yes	Vedi tabella p. 181 See table p. 181	500,00 €

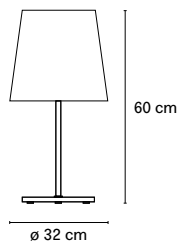

Codice Code	Materiale Material	Colore Colour	Sorgente luminosa Light source	Dimmer incluso Dimmer included	Classe energetica Energy label	Prezzo Retail con IVA Retail Price VAT incl.
F324710150KBNE	Vetro, Metallo Glass, Metal	Nichel, Bianco Nickel, White	1x max 100W E27	Si Yes	Vedi tabella p. 181 See table p. 181	700,00 €



**ASHANGHAI**  
**MAX INGRAND**  
 1955

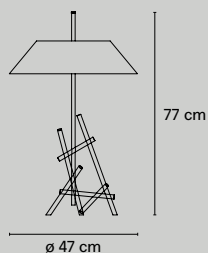

Codice Code	Materiale Material	Colore Colour	Sorgente luminosa Light source	Dimmer incluso Dimmer included	Classe energetica Energy label	Prezzo Retail con IVA Retail Price VAT incl.
F418805150CBNE	Vetro, Metallo Glass, Metal	Cromo, Bianco Chrome, White	3x max 30W E14	Si Yes	Vedi tabella p. 181 See table p. 181	2.850,00 €



**BIANCA**  
MATTI KLENELL  
2015

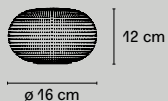

Codice Code	Materiale Material	Colore Colour	Sorgente luminosa Light source	Dimmer incluso Dimmer included	Classe energetica Energy label	Prezzo Retail con IVA Retail Price VAT incl.
F430800150BILE	Vetro, Metallo Glass, Metal	○ Bianco White	LED 4,5W (2700K, CRI>80, 350Lm)	No	F	325,00 €



LED integrato  
Integrated LED

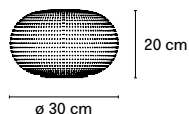

Codice Code	Materiale Material	Colore Colour	Sorgente luminosa Light source	Dimmer incluso Dimmer included	Classe energetica Energy label	Prezzo Retail con IVA Retail Price VAT incl.
F430805150BILE	Vetro, Metallo Glass, Metal	○ Bianco White	LED 17,5W (2700K, CRI>80, 1650Lm)	Si Yes	E	530,00 €



LED integrato  
Integrated LED

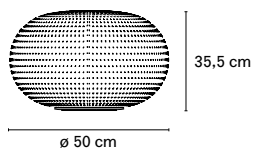







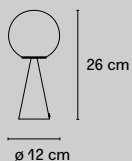













Codice Code	Materiale Material	Colore Colour	Sorgente luminosa Light source	Dimmer incluso Dimmer included	Classe energetica Energy label	Prezzo Retail con IVA Retail Price VAT incl.
F430810150BINE	Vetro, Metallo Glass, Metal	○ Bianco White	1x max 116W E27	Si Yes	Vedi tabella p. 181 See table p. 181	730,00 €



**BILIA  
GIO PONTI  
1932**









Codice Code	Materiale Material	Colore Colour	Sorgente luminosa Light source	Dimmer incluso Dimmer included	Classe energetica Energy label	Prezzo Retail con IVA Retail Price VAT incl.	
F247400150BINE	Vetro, Metallo Glass, Metal	 Bianco White	1x max 6W G9	No	Vedi tabella p. 181 See table p. 181	320,00 €	
F247400150BLNE	Vetro, Metallo Glass, Metal	 Blu Blue	1x max 6W G9	No	Vedi tabella p. 181 See table p. 181	320,00 €	
F247400150GINE	Vetro, Metallo Glass, Metal	 Giallo Yellow	1x max 6W G9	No	Vedi tabella p. 181 See table p. 181	320,00 €	
F247400150KBNE	Vetro, Metallo Glass, Metal	 Nichel, Bianco Nickel, White	1x max 6W G9	No	Vedi tabella p. 181 See table p. 181	320,00 €	
F247400150NENE	Vetro, Metallo Glass, Metal	 Nero Black	1x max 6W G9	No	Vedi tabella p. 181 See table p. 181	320,00 €	
F247400150RONE	Vetro, Metallo Glass, Metal	 Rosso Red	1x max 6W G9	No	Vedi tabella p. 181 See table p. 181	320,00 €	
F247400150VENE	Vetro, Metallo Glass, Metal	 Verde Green	1x max 6W G9	No	Vedi tabella p. 181 See table p. 181	320,00 €	
F247400150TBNE	Vetro, Metallo Glass, Metal	 Ottone, Bianco Brass, White	1x max 6W G9	No	Vedi tabella p. 181 See table p. 181	390,00 €	
F247400550NENE	Vetro, Metallo Galvanizzato Glass, Gavanized Metal	 Nero lucido Glossy black	1x max 6W G9	No	Vedi tabella p. 181 See table p. 181	390,00 €	
F247400550RSNE	Vetro, Metallo Galvanizzato Glass, Gavanized Metal	 Rame lucido Glossy copper	1x max 6W G9	No	Vedi tabella p. 181 See table p. 181	390,00 €	

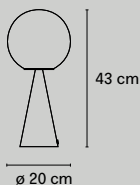

CE ENEC Classe II IP20

**BILIA  
GIO PONTI  
1932**





Codice Code	Materiale Material	Colore Colour	Sorgente luminosa Light source	Dimmer incluso Dimmer included	Classe energetica Energy label	Prezzo Retail con IVA Retail Price VAT incl.	
F247405150KBNE	Vetro, Metallo Glass, Metal	 Nichel, Bianco Nickel, White	1x max 46W E14	Si Yes	Vedi tabella p. 181 See table p. 181	590,00 €	
F247405150TBNE	Vetro, Metallo Glass, Metal	 Ottone, Bianco Brass, White	1x max 46W E14	Si Yes	Vedi tabella p. 181 See table p. 181	650,00 €	
F247405550NENE	Vetro, Metallo Galvanizzato Glass, Gavanized Metal	 Nero lucido Glossy black	1x max 46W E14	Si Yes	Vedi tabella p. 181 See table p. 181	700,00 €	
F247405550RSNE	Vetro, Metallo Galvanizzato Glass, Gavanized Metal	 Rame lucido Glossy copper	1x max 46W E14	Si Yes	Vedi tabella p. 181 See table p. 181	700,00 €	

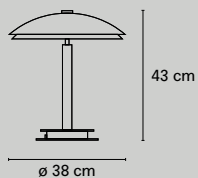

CE ENEC Classe II IP20

**BIS / TRIS**  
HISTORICAL ARCHIVE  
1954







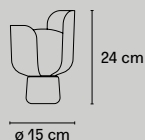

Codice Code	Materiale Material	Colore Colour	Sorgente luminosa Light source	Dimmer incluso Dimmer included	Classe energetica Energy label	Prezzo Retail con IVA Retail Price VAT incl.
F228005150TNNE	Vetro, Metallo Glass, Metal	 Ottone, Nero Brass, Black	4x max 30W E14	No	Vedi tabella p. 181 See table p. 181	1.210,00 €
F228005150CBNE	Vetro, Metallo Glass, Metal	 Cromo, Bianco Chrome, White	4x max 30W E14	No	Vedi tabella p. 181 See table p. 181	1.160,00 €



**BLOM**  
ANDREAS ENGESVIK  
2013



Codice Code	Materiale Material	Colore Colour	Sorgente luminosa Light source	Dimmer incluso Dimmer included	Classe energetica Energy label	Prezzo Retail con IVA Retail Price VAT incl.
F425305350BINE	Polimero, Alluminio Polymer, Aluminum	 Bianco White	1x max 11W E14	No	Vedi tabella p. 181 See table p. 181	190,00 €
F425305350BLNE	Polimero, Alluminio Polymer, Aluminum	 Blu Blue	1x max 11W E14	No	Vedi tabella p. 181 See table p. 181	190,00 €
F425305350GSNE	Polimero, Alluminio Polymer, Aluminum	 Grigio Scuro Dark Gray	1x max 11W E14	No	Vedi tabella p. 181 See table p. 181	190,00 €
F425305350GINE	Polimero, Alluminio Polymer, Aluminum	 Giallo Yellow	1x max 11W E14	No	Vedi tabella p. 181 See table p. 181	190,00 €
F425305350VINE	Polimero, Alluminio Polymer, Aluminum	 Viola Violet	1x max 11W E14	No	Vedi tabella p. 181 See table p. 181	190,00 €
F425305350VENE	Polimero, Alluminio Polymer, Aluminum	 Verde Green	1x max 11W E14	No	Vedi tabella p. 181 See table p. 181	190,00 €
F425305350RSNE	Polimero, Alluminio Polymer, Aluminum	 Rosa Pink	1x max 11W E14	No	Vedi tabella p. 181 See table p. 181	190,00 €



**CHESHIRE**  
GAMFRATESI  
2013



Codice Code	Materiale Material	Colore Colour	Sorgente luminosa Light source	Dimmer incluso Dimmer included	Classe energetica Energy label	Prezzo Retail con IVA Retail Price VAT incl.
F425105350BINE	Polimero, Metallo Polymer, Metal	○ Bianco White	3x max 23W E27	No	Vedi tabella p. 181 See table p. 181	520,00 €
F425105350NENE	Polimero, Metallo Polymer, Metal	● Nero Black	3x max 23W E27	No	Vedi tabella p. 181 See table p. 181	520,00 €



**DARUMA**  
SERGIO ASTI  
1968

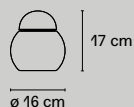

Codice Code	Materiale Material	Colore Colour	Sorgente luminosa Light source	Dimmer incluso Dimmer included	Classe energetica Energy label	Prezzo Retail con IVA Retail Price VAT incl.
F502800100BINE	Vetro Glass	○ Bianco White	1x max 20W E27	No	Vedi tabella p. 181 See table p. 181	325,00 €

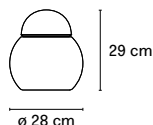

Codice Code	Materiale Material	Colore Colour	Sorgente luminosa Light source	Dimmer incluso Dimmer included	Classe energetica Energy label	Prezzo Retail con IVA Retail Price VAT incl.
F502805100BINE	Vetro Glass	○ Bianco White	1x max 46W E27	No	Vedi tabella p. 181 See table p. 181	500,00 €

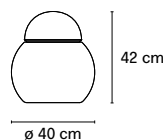





Codice Code	Materiale Material	Colore Colour	Sorgente luminosa Light source	Dimmer incluso Dimmer included	Classe energetica Energy label	Prezzo Retail con IVA Retail Price VAT incl.
F502810100BINE	Vetro Glass	○ Bianco White	1x max 100W E27	No	Vedi tabella p. 181 See table p. 181	860,00 €

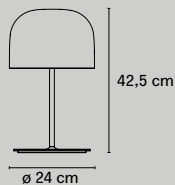

**EQUATORE**  
GABRIELE E OSCAR BURATTI  
2017



Codice Code	Materiale Material	Colore Colour	Sorgente luminosa Light source	Dimmer incluso Dimmer included	Classe energetica Energy label	Prezzo Retail con IVA Retail Price VAT incl.
F438900550CRWL	Vetro, Metallo Galvanizzato Glass, Galvanized Metal	 Cromo Chrome	LED 25W (2700K, CRI>90, 2900Lm)	Si Yes	F	1.420,00 €
F438900550NEWL	Vetro, Metallo Galvanizzato Glass, Galvanized Metal	 Nero lucido Glossy black	LED 25W (2700K, CRI>90, 2900Lm)	Si Yes	F	1.420,00 €
F438900150OOWL	Vetro, Metallo Glass, Metal	 Oro opaco Matt gold	LED 25W (2700K, CRI>90, 2900Lm)	Si Yes	F	1.250,00 €
F438900550RSWL	Vetro, Metallo Galvanizzato Glass, Galvanized Metal	 Rame lucido Glossy copper	LED 25W (2700K, CRI>90, 2900Lm)	Si Yes	F	1.420,00 €







LED integrato  
Integrated LED

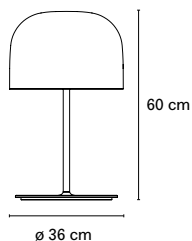

Su richiesta tecnologia  
Dali o Casambi  
Dali or Casambi  
technology on request



Codice Code	Materiale Material	Colore Colour	Sorgente luminosa Light source	Dimmer incluso Dimmer included	Classe energetica Energy label	Prezzo Retail con IVA Retail Price VAT incl.
F438905550CRWL	Vetro, Metallo Galvanizzato Glass, Galvanized Metal	 Cromo Chrome	LED 40W (2700K, CRI>90, 4500Lm)	Si Yes	F	2.050,00 €
F438905550NEWL	Vetro, Metallo Galvanizzato Glass, Galvanized Metal	 Nero lucido Glossy black	LED 40W (2700K, CRI>90, 4500Lm)	Si Yes	F	2.050,00 €
F438905150OOWL	Vetro, Metallo Glass, Metal	 Oro opaco Matt gold	LED 40W (2700K, CRI>90, 4500Lm)	Si Yes	F	1.860,00 €
F438905550RSWL	Vetro, Metallo Galvanizzato Glass, Galvanized Metal	 Rame lucido Glossy copper	LED 40W (2700K, CRI>90, 4500Lm)	Si Yes	F	2.050,00 €



LED integrato  
Integrated LED



Su richiesta tecnologia  
Dali o Casambi  
Dali or Casambi  
technology on request

**FALENA**  
ALVARO SIZA  
1994

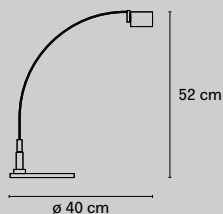

Codice Code	Materiale Material	Colore Colour	Sorgente luminosa Light source	Dimmer incluso Dimmer included	Classe energetica Energy label	Prezzo Retail con IVA Retail Price VAT incl.
F301705150CRNE	Vetro, Metallo Glass, Metal	Cromo Chrome	1x max 50W GY6.35	No	Vedi tabella p. 181 See table p. 181	640,00 €

CE ENEC Classe II IP20

**FONTANA**  
MAX INGRAND  
1954

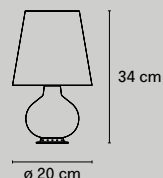

Codice Code	Materiale Material	Colore Colour	Sorgente luminosa Light source	Dimmer incluso Dimmer included	Classe energetica Energy label	Prezzo Retail con IVA Retail Price VAT incl.
F185300100BINE	Vetro Glass	Bianco White	1x max 59W E27 + 2x max 19W G9	No	Vedi tabella p. 181 See table p. 181	595,00 €



Doppia accensione  
Double light controls

CE ENEC Classe II IP20

Codice Code	Materiale Material	Colore Colour	Sorgente luminosa Light source	Dimmer incluso Dimmer included	Classe energetica Energy label	Prezzo Retail con IVA Retail Price VAT incl.
F185300200OTNE	Metallo Metal	Ottone Brass	1x max 100W E27	Sì Yes	Vedi tabella p. 181 See table p. 181	1.050,00 €

CE ENEC Classe II IP20

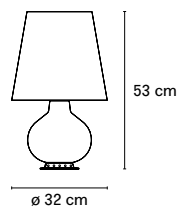

Codice Code	Materiale Material	Colore Colour	Sorgente luminosa Light source	Dimmer incluso Dimmer included	Classe energetica Energy label	Prezzo Retail con IVA Retail Price VAT incl.
F185305100BINE	Vetro Glass	Bianco White	1x max 100W E27 + 2x max 30W E14	No	Vedi tabella p. 181 See table p. 181	895,00 €



Doppia accensione  
Double light controls



CE ENEC Classe II IP20

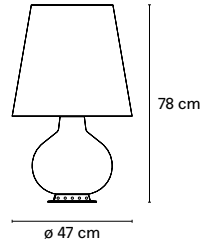

Codice Code	Materiale Material	Colore Colour	Sorgente luminosa Light source	Dimmer incluso Dimmer included	Classe energetica Energy label	Prezzo Retail con IVA Retail Price VAT incl.
F185305200OTNE	Metallo Metal	 Ottone Brass	1x max 100W E27	Si, Yes	Vedi tabella p. 181 See table p. 181	1.460,00 €

CE ENEC Classe #  IP20



Codice Code	Materiale Material	Colore Colour	Sorgente luminosa Light source	Dimmer incluso Dimmer included	Classe energetica Energy label	Prezzo Retail con IVA Retail Price VAT incl.
F185310100BINE	Vetro Glass	 Bianco White	1x max 100W E27 + 4x max 46W E27 + 3x max 30W E14	No	Vedi tabella p. 181 See table p. 181	1.650,00 € 





Tripla accensione  
Triple light controls

CE ENEC Classe #  IP20

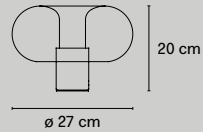
## FONTANELLA FEDERICO PERI 2020



Codice Code	Materiale Material	Colore Colour	Sorgente luminosa Light source	Dimmer incluso Dimmer included	Classe energetica Energy label	Prezzo Retail con IVA Retail Price VAT incl.
F442305550CRNE	Vetro, Metallo Galvanizzato Glass, Galvanized Metal	 Cromo Chrome	1x max 28W E14	Si Yes	Vedi tabella p. 181 See table p. 181	540,00 €
F442305550NENE	Vetro, Metallo Galvanizzato Glass, Galvanized Metal	 Nero lucido Glossy black	1x max 28W E14	Si Yes	Vedi tabella p. 181 See table p. 181	540,00 €
F442305550OTNE	Vetro, Metallo Galvanizzato Glass, Galvanized Metal	 Ottone lucido Glossy Brass	1x max 28W E14	Si Yes	Vedi tabella p. 181 See table p. 181	540,00 €



CE Classe #  IP20

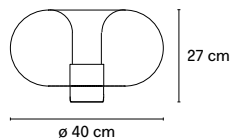

Codice Code	Materiale Material	Colore Colour	Sorgente luminosa Light source	Dimmer incluso Dimmer included	Classe energetica Energy label	Prezzo Retail con IVA Retail Price VAT incl.
F442310550CRNE	Vetro, Metallo Galvanizzato Glass, Galvanized Metal	Cromo Chrome	1x max 77W E27	Si Yes	Vedi tabella p. 181 See table p. 181	800,00 €
F442310550NENE	Vetro, Metallo Galvanizzato Glass, Galvanized Metal	Nero lucido Glossy black	1x max 77W E27	Si Yes	Vedi tabella p. 181 See table p. 181	800,00 €
F442310550OTNE	Vetro, Metallo Galvanizzato Glass, Galvanized Metal	Ottone lucido Glossy Brass	1x max 77W E27	Si Yes	Vedi tabella p. 181 See table p. 181	800,00 €



CE Classe II IP20

## GIOVA GAE AULENTI 1964

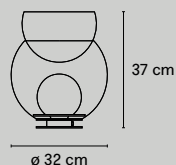

Codice Code	Materiale Material	Colore Colour	Sorgente luminosa Light source	Dimmer incluso Dimmer included	Classe energetica Energy label	Prezzo Retail con IVA Retail Price VAT incl.
F268405150CRNE	Vetro, Metallo Glass, Metal	Cromo, Rosa Chrome, Pink	1x max 46W E27	No	Vedi tabella p. 181 See table p. 181	1.200,00 €
F268405575OONE	Vetro, Metallo Galvanizzato Glass, Galvanized Metal	Oro, Grigio Gold, Gray	1x max 46W E27	No	Vedi tabella p. 181 See table p. 181	1.380,00 €



CE ENEC Classe II IP20

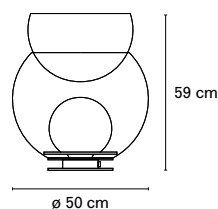

Codice Code	Materiale Material	Colore Colour	Sorgente luminosa Light source	Dimmer incluso Dimmer included	Classe energetica Energy label	Prezzo Retail con IVA Retail Price VAT incl.
F268410150CRNE	Vetro, Metallo Glass, Metal	Cromo, Rosa Chrome, Pink	1x max 100W E27	No	Vedi tabella p. 181 See table p. 181	1.750,00 €
F268410575OONE	Vetro, Metallo Galvanizzato Glass, Galvanized Metal	Oro, Grigio Gold, Gray	1x max 100W E27	No	Vedi tabella p. 181 See table p. 181	1.930,00 €



CE ENEC Classe II IP20

**KINX**  
KARIM RASHID  
2015

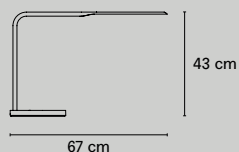

Codice Code	Materiale Material	Colore Colour	Sorgente luminosa Light source	Dimmer incluso Dimmer included	Classe energetica Energy label	Prezzo Retail con IVA Retail Price VAT incl.
F431205200NEWL	Metallo Metal	● Nero Black	LED 7,5W (2700K, CRI>80, 940Lm)	Si, touch Yes, touch	F	595,00 €
Base provvista di porta USB Base provided with USB port			LED integrato Integrated LED	CE ENEC	Classe III IP20	

**LASOSPESA**  
STEFANO BOERI  
ARCHITETTI  
2019

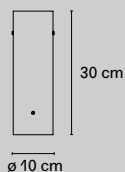

Codice Code	Materiale Material	Colore Colour	Sorgente luminosa Light source	Dimmer incluso Dimmer included	Classe energetica Energy label	Prezzo Retail con IVA Retail Price VAT incl.
F443105150TRWL	Vetro, Metallo Glass, Metal	○ Trasparente Transparent	LED 6,5W (2700K, CRI>80, 700Lm)	Si Yes	F	620,00 €
			LED integrato Integrated LED	CE ENEC	Classe III IP20	

**LOOP**  
VOON WONG  
& BENSON SAW  
2003

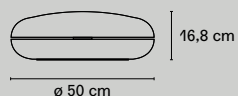

Codice Code	Materiale Material	Colore Colour	Sorgente luminosa Light source	Dimmer incluso Dimmer included	Classe energetica Energy label	Prezzo Retail con IVA Retail Price VAT incl.
F542910200AXLE	Metallo Metal	● Acciaio Steel	LED 28,6W (3000K, CRI>80, 3650Lm)	No	D	1.590,00 €
			LED integrato Integrated LED	CE ENEC	Classe II IP20	

**MANO**  
PIETRO CHIESA  
1932

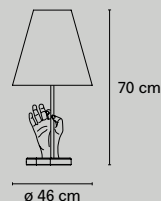

Codice Code	Materiale Material	Colore Colour	Sorgente luminosa Light source	Dimmer incluso Dimmer included	Classe energetica Energy label	Prezzo Retail con IVA Retail Price VAT incl.
F420805400NENE	Metallo, Tessuto Metal, Fabric	Nero Black	1x max 57W E27	Si Yes	Vedi tabella p. 181 See table p. 181	650,00 €



**MATRIX**  
STUDIO OS Δ OOS  
2020

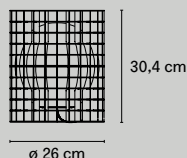

Codice Code	Materiale Material	Colore Colour	Sorgente luminosa Light source	Dimmer incluso Dimmer included	Classe energetica Energy label	Prezzo Retail con IVA Retail Price VAT incl.
F444305250BIWL	Vetro, Metallo Glass, Metal	Bianco White	LED 8W (2700K, CRI>90, 1180Lm)	Si Yes	F	1.300,00 €
F444305250OBWL	Vetro, Metallo Glass, Metal	Oro, Bianco Gold, White	LED 8W (2700K, CRI>90, 1180Lm)	Si Yes	F	1.500,00 €



LED integrato  
Integrated LED

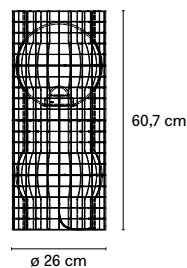

Codice Code	Materiale Material	Colore Colour	Sorgente luminosa Light source	Dimmer incluso Dimmer included	Classe energetica Energy label	Prezzo Retail con IVA Retail Price VAT incl.
F444310250BIWL	Vetro, Metallo Glass, Metal	Bianco White	LED 8W (2700K, CRI>90, 1180Lm)	Si Yes	F	2.150,00 €
F444310250OBWL	Vetro, Metallo Glass, Metal	Oro, Bianco Gold, White	LED 8W (2700K, CRI>90, 1180Lm)	Si Yes	F	2.400,00 €



LED integrato  
Integrated LED



**MERIDIANO**  
GABRIELE E OSCAR BURATTI  
2020

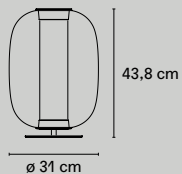

Codice Code	Materiale Material	Colore Colour	Sorgente luminosa Light source	Dimmer incluso Dimmer included	Classe energetica Energy label	Prezzo Retail con IVA Retail Price VAT incl.
F441705550NFWL	Vetro, Metallo Galvanizzato Glass, Galvanized Metal	● Nero, Fumè Black, Grey fumè	LED 25W (2700K, CRI>90, 2900Lm)	Si Yes	F	1.700,00 €
F441705550NRWL	Vetro, Metallo Galvanizzato Glass, Galvanized Metal	● Nero, Rosa Black, Pink	LED 25W (2700K, CRI>90, 2900Lm)	Si Yes	F	1.700,00 €
F441705550NTWL	Vetro, Metallo Galvanizzato Glass, Galvanized Metal	● Nero, Trasparente Black, Transparent	LED 25W (2700K, CRI>90, 2900Lm)	Si Yes	F	1.700,00 €
			LED integrato Integrated LED			

**METAFORA**  
UMBERTO RIVA  
1980 Re-Edition

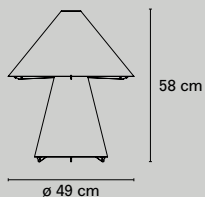

Codice Code	Materiale Material	Colore Colour	Sorgente luminosa Light source	Dimmer incluso Dimmer included	Classe energetica Energy label	Prezzo Retail con IVA Retail Price VAT incl.
F265405150BTNE	Vetro, Metallo Glass, Metal	○ Bianco, Trasparente White, Transparent	1x max 116W E27	Si Yes	Vedi tabella p. 181 See table p. 181	1.080,00 €

**NASKA**  
HISTORICAL ARCHIVE  
1933

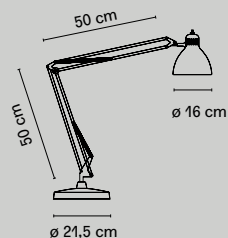

Codice Code	Materiale Material	Colore Colour	Sorgente luminosa Light source	Dimmer incluso Dimmer included	Classe energetica Energy label	Prezzo Retail con IVA Retail Price VAT incl.
F810010200BINE	Metallo Verniciato Painted Metal	○ Bianco White	1x max 46W E27	No	Vedi tabella p. 181 See table p. 181	545,00 €
F810010240CRNE	Metallo Galvanizzato Galvanized Metal	◐ Cromo Chrome	1x max 46W E27	No	Vedi tabella p. 181 See table p. 181	630,00 €
F810010200NENE	Metallo Verniciato Painted Metal	● Nero Black	1x max 46W E27	No	Vedi tabella p. 181 See table p. 181	545,00 €

CE ENEC Classe III IP20

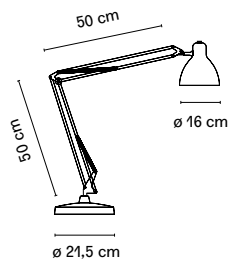

Codice Code	Materiale Material	Colore Colour	Sorgente luminosa Light source	Dimmer incluso Dimmer included	Classe energetica Energy label	Prezzo Retail con IVA Retail Price VAT incl.
F810010200BIWL	Metallo Verniciato Painted Metal	○ Bianco White	LED 6W (2700K, CRI>80, 800Lm)	Si, touch Yes, touch	F	570,00 €
F810010240CRWL	Metallo Galvanizzato Galvanized Metal	◐ Cromo Chrome	LED 6W (2700K, CRI>80, 800Lm)	Si, touch Yes, touch	F	670,00 €
F810010200NEWL	Metallo Verniciato Painted Metal	● Nero Black	LED 6W (2700K, CRI>80, 800Lm)	Si, touch Yes, touch	F	570,00 €
F810010240OOWL	Metallo Galvanizzato Galvanized Metal	● Oro Gold	LED 6W (2700K, CRI>80, 800Lm)	Si, touch Yes, touch	F	670,00 €

LED integrato Integrated LED

CE ENEC Classe III IP20

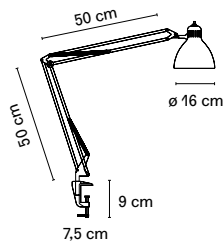

Codice Code	Materiale Material	Colore Colour	Sorgente luminosa Light source	Dimmer incluso Dimmer included	Classe energetica Energy label	Prezzo Retail con IVA Retail Price VAT incl.
F810110200BINE	Metallo Verniciato Painted Metal	○ Bianco White	1x max 46W E27	No	Vedi tabella p. 181 See table p. 181	440,00 €
F810110240CRNE	Metallo Galvanizzato Galvanized Metal	◐ Cromo Chrome	1x max 46W E27	No	Vedi tabella p. 181 See table p. 181	540,00 €
F810110200NENE	Metallo Verniciato Painted Metal	● Nero Black	1x max 46W E27	No	Vedi tabella p. 181 See table p. 181	440,00 €

CE ENEC Classe II IP20

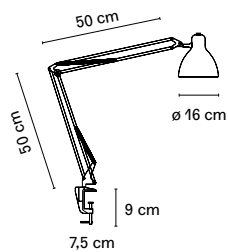

Codice Code	Materiale Material	Colore Colour	Sorgente luminosa Light source	Dimmer incluso Dimmer included	Classe energetica Energy label	Prezzo Retail con IVA Retail Price VAT incl.
F810110200BIWL	Metallo Verniciato Painted Metal	○ Bianco White	LED 6W (2700K, CRI>80, 800Lm)	Si, touch Yes, touch	F	470,00 €
F810110240CRWL	Metallo Galvanizzato Galvanized Metal	◐ Cromo Chrome	LED 6W (2700K, CRI>80, 800Lm)	Si, touch Yes, touch	F	570,00 €
F810110200NEWL	Metallo Verniciato Painted Metal	● Nero Black	LED 6W (2700K, CRI>80, 800Lm)	Si, touch Yes, touch	F	470,00 €
F810110240OOWL	Metallo Galvanizzato Galvanized Metal	◑ Oro, Nero Gold, Black	LED 6W (2700K, CRI>80, 800Lm)	Si, touch Yes, touch	F	570,00 €

LED integrato Integrated LED

CE ENEC Classe II IP20

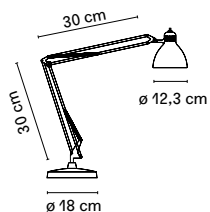

Codice Code	Materiale Material	Colore Colour	Sorgente luminosa Light source	Dimmer incluso Dimmer included	Classe energetica Energy label	Prezzo Retail con IVA Retail Price VAT incl.
F810700200BINE	Metallo Verniciato Painted Metal	○ Bianco White	1x max 30W E27	No	Vedi tabella p. 181 See table p. 181	485,00 €
F810700240CRNE	Metallo Galvanizzato Galvanized Metal	◐ Cromo Chrome	1x max 30W E27	No	Vedi tabella p. 181 See table p. 181	580,00 €
F810700200NENE	Metallo Verniciato Painted Metal	● Nero Black	1x max 30W E27	No	Vedi tabella p. 181 See table p. 181	485,00 €

CE ENEC Classe II IP20

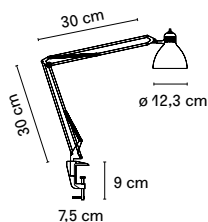

Codice Code	Materiale Material	Colore Colour	Sorgente luminosa Light source	Dimmer incluso Dimmer included	Classe energetica Energy label	Prezzo Retail con IVA Retail Price VAT incl.
F810100200BINE	Metallo Verniciato Painted Metal	○ Bianco White	1x max 30W E27	No	Vedi tabella p. 181 See table p. 181	430,00 €
F810100240CRNE	Metallo Galvanizzato Galvanized Metal	◐ Cromo Chrome	1x max 30W E27	No	Vedi tabella p. 181 See table p. 181	495,00 €
F810100200NENE	Metallo Verniciato Painted Metal	● Nero Black	1x max 30W E27	No	Vedi tabella p. 181 See table p. 181	430,00 €

CE ENEC Classe II IP20



**OORT SISTEMA**  
**JACOPO RODA**  
**2022**

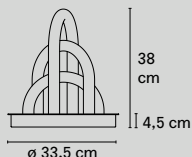

Codice Code	Materiale Material	Colore Colour	Sorgente luminosa Light source	Dimmer incluso Dimmer included	Classe energetica Energy label	Prezzo Retail con IVA Retail Price VAT incl.
OORT00020	Vetro, Metallo Glass, Metal	Bianco, Specchio White, Mirror	LED 8W + 12W + 16W (3000K, 3400Lm)	Si, Yes	G	1.240,00 €
OORT00021	Vetro, Metallo Glass, Metal	Bianco, Specchio White, Mirror	LED 8W + 12W + 16W (DTW da 1800K a 4000K)	Si, Yes	G	1.330,00 €
			LED integrato Integrated LED	<small>Classe II</small> IP20		
			Su richiesta 2700K 2700K on request			

**PALLINA**  
**FONTANAARTE DESIGN LAB**  
**2019**

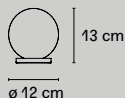

Codice Code	Materiale Material	Colore Colour	Sorgente luminosa Light source	Dimmer incluso Dimmer included	Classe energetica Energy label	Prezzo Retail con IVA Retail Price VAT incl.
F443000150NENE	Vetro, Metallo Galvanizzato Glass, Galvanized Metal	Nero lucido Glossy black	1x max 6W G9	No	Vedi tabella p. 181 See table p. 181	210,00 €
F443000150NSNE	Vetro, Metallo Galvanizzato Glass, Galvanized Metal	Nichel lucido Glossy nickel	1x max 6W G9	No	Vedi tabella p. 181 See table p. 181	210,00 €
F443000150OTNE	Vetro, Metallo Galvanizzato Glass, Galvanized Metal	Ottone lucido Glossy brass	1x max 6W G9	No	Vedi tabella p. 181 See table p. 181	210,00 €
F443000150ORNE	Vetro, Metallo Verniciato Glass, Painted Metal	Oro rosa Rose gold	1x max 6W G9	No	Vedi tabella p. 181 See table p. 181	220,00 €
			VETRO SOFFIATO BLOWN GLASS	<small>Classe II</small> IP20		

**PAROLA**  
**GAE AULENTI**  
**E PIERO CASTIGLIONI**  
**1980**

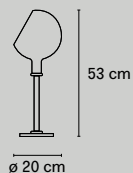

Codice Code	Materiale Material	Colore Colour	Sorgente luminosa Light source	Dimmer incluso Dimmer included	Classe energetica Energy label	Prezzo Retail con IVA Retail Price VAT incl.
F265805100AMNE	Vetro Glass	Ambra Amber	1x max 46W E14	Si Yes	Vedi tabella p. 181 See table p. 181	910,00 €
F265805100BINE	Vetro Glass	Bianco White	1x max 46W E14	Si Yes	Vedi tabella p. 181 See table p. 181	910,00 €
			VETRO SOFFIATO BLOWN GLASS	<small>Classe II</small> IP20		

**PASSION**  
STUDIO BERETTA  
ASSOCIATI  
2004

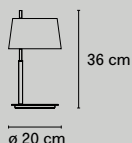

Codice Code	Materiale Material	Colore Colour	Sorgente luminosa Light source	Dimmer incluso Dimmer included	Classe energetica Energy label	Prezzo Retail con IVA Retail Price VAT incl.
F361000150CRNE	Vetro, Metallo Glass, Metal	Cromo, Bianco Chrome, White	1x max 48W G9	Si Yes	Vedi tabella p. 181 See table p. 181	620,00 €
F361000150NCNE	Vetro, Metallo Glass, Metal	Nichel, Bianco Nickel, White	1x max 48W G9	Si Yes	Vedi tabella p. 181 See table p. 181	620,00 €

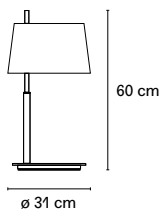

Codice Code	Materiale Material	Colore Colour	Sorgente luminosa Light source	Dimmer incluso Dimmer included	Classe energetica Energy label	Prezzo Retail con IVA Retail Price VAT incl.
F361005150CRNE	Vetro, Metallo Glass, Metal	Cromo, Bianco Chrome, White	1x max 116W E27	Si Yes	Vedi tabella p. 181 See table p. 181	990,00 €
F361005150NCNE	Vetro, Metallo Glass, Metal	Nichel, Bianco Nickel, White	1x max 116W E27	Si Yes	Vedi tabella p. 181 See table p. 181	990,00 €



**PINECONE**  
PAOLA NAVONE  
2016

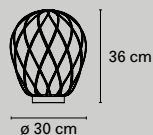

Codice Code	Materiale Material	Colore Colour	Sorgente luminosa Light source	Dimmer incluso Dimmer included	Classe energetica Energy label	Prezzo Retail con IVA Retail Price VAT incl.
F436405550TCNE	Vetro, Metallo Galvanizzato Glass, Galvanized Metal	Trasparente, Cromo Transparent, Chrome	1x max 116W E27	Si Yes	Vedi tabella p. 181 See table p. 181	1.750,00 €
F436405550CBNE	Vetro, Metallo Galvanizzato Glass, Galvanized Metal	Bianco, Cromo White, Chrome	1x max 116W E27	Si Yes	Vedi tabella p. 181 See table p. 181	1.750,00 €
F436405575TONE	Vetro, Metallo Galvanizzato Glass, Galvanized Metal	Trasparente, Oro Transparent, Gold	1x max 116W E27	Si Yes	Vedi tabella p. 181 See table p. 181	1.850,00 €
F436405575OBNE	Vetro, Metallo Galvanizzato Glass, Galvanized Metal	Bianco, Oro White, Gold	1x max 116W E27	Si Yes	Vedi tabella p. 181 See table p. 181	1.850,00 €



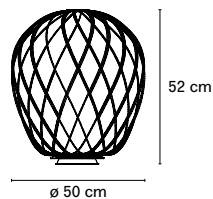

Codice Code	Materiale Material	Colore Colour	Sorgente luminosa Light source	Dimmer incluso Dimmer included	Classe energetica Energy label	Prezzo Retail con IVA Retail Price VAT incl.
F434010550TCNE	Vetro, Metallo Galvanizzato Glass, Galvanized Metal	Trasparente, Cromo Transparent, Chrome	1x max 116W E27	Si Yes	Vedi tabella p. 181 See table p. 181	2.150,00 €
F434010550CBNE	Vetro, Metallo Galvanizzato Glass, Galvanized Metal	Bianco, Cromo White, Chrome	1x max 116W E27	Si Yes	Vedi tabella p. 181 See table p. 181	2.150,00 €
F434010575TONE	Vetro, Metallo Galvanizzato Glass, Galvanized Metal	Trasparente, Oro Transparent, Gold	1x max 116W E27	Si Yes	Vedi tabella p. 181 See table p. 181	2.540,00 €
F434010575OBNE	Vetro, Metallo Galvanizzato Glass, Galvanized Metal	Bianco, Oro White, Gold	1x max 116W E27	Si Yes	Vedi tabella p. 181 See table p. 181	2.540,00 €

VETRO SOFFIATO  
BLOWN GLASS
 
 Classe II IP20

## PIRELLINA GIO PONTI 1967

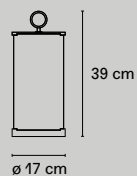

Codice Code	Materiale Material	Colore Colour	Sorgente luminosa Light source	Dimmer incluso Dimmer included	Classe energetica Energy label	Prezzo Retail con IVA Retail Price VAT incl.
F278205150KBNE	Vetro, Metallo Glass, Metal	Nichel, Bianco Nickel, White	4x max 20W E14	Si Yes	Vedi tabella p. 181 See table p. 181	510,00 €

VETRO SOFFIATO  
BLOWN GLASS
 
 Classe II IP20

## RE BOBO PICCOLI 1968 Re-Edition

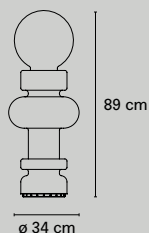

Codice Code	Materiale Material	Colore Colour	Sorgente luminosa Light source	Dimmer incluso Dimmer included	Classe energetica Energy label	Prezzo Retail con IVA Retail Price VAT incl.
F443810100BIWL	Vetro Glass	Bianco White	LED 48W (3000K, CRI>85, 4800Lm)	Si Yes	F	2.350,00 €

VETRO SOFFIATO  
BLOWN GLASS
 
 Classe III IP20

**REGINA**  
BOBO PICCOLI  
1968 Re-Edition

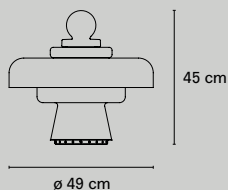

Codice Code	Materiale Material	Colore Colour	Sorgente luminosa Light source	Dimmer incluso Dimmer included	Classe energetica Energy label	Prezzo Retail con IVA Retail Price VAT incl.
F443710100BIWL	Vetro Glass	○ Bianco White	LED 54W (3000K, CRI>85, 5500Lm)	Si Yes	F	2.150,00 €
			LED integrato Integrated LED	CE ENEC <small>Classe III</small> IP20		



**SETAREH**  
FRANCESCO LIBRIZZI  
2017

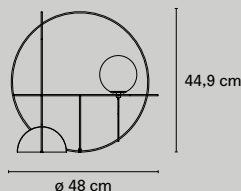

Codice Code	Materiale Material	Colore Colour	Sorgente luminosa Light source	Dimmer incluso Dimmer included	Classe energetica Energy label	Prezzo Retail con IVA Retail Price VAT incl.
F440105500NBWL	Vetro, Metallo Galvanizzato, Marmo Glass, Galvanized Metal, Marble	● Nero lucido, Bianco Glossy black, White	LED 6W (2700K, CRI>80, 830Lm)	Si Yes	E	1.100,00 €
F440105500OBWL	Vetro, Metallo Galvanizzato, Marmo Glass, Galvanized Metal, Marble	● Oro lucido, Bianco Glossy gold, White	LED 6W (2700K, CRI>80, 830Lm)	Si Yes	E	1.100,00 €





Base in marmo bianco di Carrara per la versione oro e in grigio Carrara per la versione nero  
Base made in white Carrara marble for the gold version and in gray Carrara marble for black version

LED integrato Integrated LED

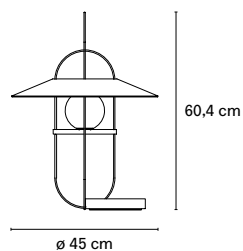

CE ENEC Classe III IP20



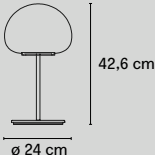

Codice Code	Materiale Material	Colore Colour	Sorgente luminosa Light source	Dimmer incluso Dimmer included	Classe energetica Energy label	Prezzo Retail con IVA Retail Price VAT incl.
F438405500NBWL	Vetro, Metallo Galvanizzato, Marmo Glass, Galvanized Metal, Marble	● Nero lucido, Bianco Glossy black, White	LED 6W (2700K, CRI>80, 830Lm)	Si Yes	E	1.250,00 €

F438405500BWL	Vetro, Metallo Galvanizzato, Marmo Glass, Galvanized Metal, Marble	 Oro lucido, Bianco Glossy gold, White	LED 6W (2700K, CRI>80, 830Lm)	Si Yes	E	1.250,00 €
 <p>Base in marmo bianco di Carrara per la versione oro e in grigio Carrino per la versione nero Base made in white Carrara marble for the gold version and in gray Carrino marble for black version</p>		LED integrato Integrated LED				

**THEA**  
GABRIELE E OSCAR BURATTI  
2022

Codice Code	Materiale Material	Colore Colour	Sorgente luminosa Light source	Dimmer incluso Dimmer included	Classe energetica Energy label	Prezzo Retail con IVA Retail Price VAT incl.
F444905550NFWL	Vetro, Metallo Galvanizzato Glass, Galvanized Metal	 Nero lucido, Fumè Glossy black, Grey fumè	LED 3,85W (3000K, CRI>90, 640Lm)	Si Yes	F	1.090,00 €
F444905575RTWL	Vetro, Metallo Galvanizzato Glass, Galvanized Metal	 Rame lucido, Trasparente Glossy copper, Transparent	LED 3,85W (3000K, CRI>90, 640Lm)	Si Yes	F	1.090,00 € 





LED integrato  
Integrated LED

 Classe III  
IP20

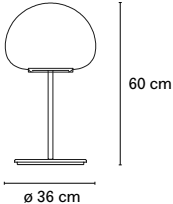
Su richiesta con  
tecnologia Casambi  
Casambi technology on  
request



Codice Code	Materiale Material	Colore Colour	Sorgente luminosa Light source	Dimmer incluso Dimmer included	Classe energetica Energy label	Prezzo Retail con IVA Retail Price VAT incl.
F444910550NFWL	Vetro, Metallo Galvanizzato Glass, Galvanized Metal	 Nero lucido, Fumè Glossy black, Grey fumè	LED 11,6W (3000K, CRI>90, 1596Lm)	Si Yes	F	1.590,00 €
F444910575RTWL	Vetro, Metallo Galvanizzato Glass, Galvanized Metal	 Rame lucido, Trasparente Glossy copper, Transparent	LED 11,6W (3000K, CRI>90, 1596Lm)	Si Yes	F	1.590,00 € 



LED integrato  
Integrated LED

 Classe III  
IP20

Su richiesta con  
tecnologia Casambi  
Casambi technology on  
request

**THOR**  
PAGANI PERVERSI  
ARCHITECTS  
2000



Codice Code	Materiale Material	Colore Colour	Sorgente luminosa Light source	Dimmer incluso Dimmer included	Classe energetica Energy label	Prezzo Retail con IVA Retail Price VAT incl.
F329500100BINE	Vetro Glass	○ Bianco White	1x max 30W E14	No	Vedi tabella p. 181 See table p. 181	390,00 €

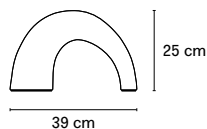

Codice Code	Materiale Material	Colore Colour	Sorgente luminosa Light source	Dimmer incluso Dimmer included	Classe energetica Energy label	Prezzo Retail con IVA Retail Price VAT incl.
F329505100BINE	Vetro Glass	○ Bianco White	1x max 46W E27	No	Vedi tabella p. 181 See table p. 181	505,00 €



**TROPICO**  
GABRIELE E OSCAR BURATTI  
2020

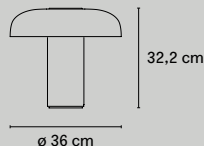

Codice Code	Materiale Material	Colore Colour	Sorgente luminosa Light source	Dimmer incluso Dimmer included	Classe energetica Energy label	Prezzo Retail con IVA Retail Price VAT incl.
F442105585BIWL	Vetro, Metallo Galvanizzato, Marmo Glass, Galvanized Metal, Marble	● Bianco, Oro lucido White, Glossy gold	LED 32W (3000K, CRI>80, 3700Lm)	Si Yes	F	1.180,00 €
F442105585GCWL	Vetro, Metallo Galvanizzato, Marmo Glass, Galvanized Metal, Marble	● Grigio, Nero lucido Gray, Glossy black	LED 32W (3000K, CRI>80, 3700Lm)	Si Yes	F	1.180,00 €
F442105585NEWL	Vetro, Metallo Galvanizzato, Marmo Glass, Galvanized Metal, Marble	● Nero, Nero lucido Black, Glossy black	LED 32W (3000K, CRI>80, 3700Lm)	Si Yes	F	1.180,00 €



LED integrato  
Integrated LED



Base in marmo bianco di Carrara con bottone oro, base in marmo grigio Bardiglio e nero Marquina con bottone nero  
White Carrara marble base with polished gold button, Bardiglio grey and Marquina black marble base with polished black button

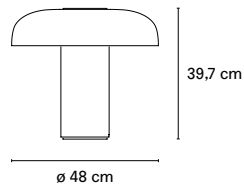

Codice Code	Materiale Material	Colore Colour	Sorgente luminosa Light source	Dimmer incluso Dimmer included	Classe energetica Energy label	Prezzo Retail con IVA Retail Price VAT incl.
F442110585BIWL	Vetro, Metallo Galvanizzato, Marmo Glass, Galvanized Metal, Marble	Bianco, Oro lucido White, Glossy gold	LED 42W (3000K, CRI>80, 4780Lm)	Si Yes	F	1.800,00 €
F442110585GCWL	Vetro, Metallo Galvanizzato, Marmo Glass, Galvanized Metal, Marble	Grigio, Nero lucido Gray, Glossy black	LED 42W (3000K, CRI>80, 4780Lm)	Si Yes	F	1.800,00 €
F442110585NEWL	Vetro, Metallo Galvanizzato, Marmo Glass, Galvanized Metal, Marble	Nero, Nero lucido Black, Glossy black	LED 42W (3000K, CRI>80, 4780Lm)	Si Yes	F	1.800,00 €
VETRO SOFFIATO BLOWN GLASS  Base in marmo bianco di Carrara con bottone oro, base in marmo grigio Bardiglio e nero Marquinia con bottone nero White Carrara marble base with polished gold button, Bardiglio grey and Marquinia black marble base with polished black button			LED integrato Integrated LED	IP20		

## UOVO BEN SWILDENS 1972

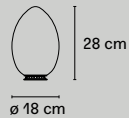

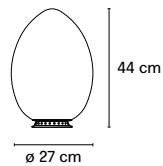

Codice Code	Materiale Material	Colore Colour	Sorgente luminosa Light source	Dimmer incluso Dimmer included	Classe energetica Energy label	Prezzo Retail con IVA Retail Price VAT incl.
F264600100BINE	Vetro Glass	Bianco White	1x max 30W E27	Si Yes	Vedi tabella p. 181 See table p. 181	325,00 €
VETRO SOFFIATO BLOWN GLASS				IP20		

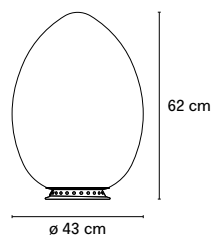

Codice Code	Materiale Material	Colore Colour	Sorgente luminosa Light source	Dimmer incluso Dimmer included	Classe energetica Energy label	Prezzo Retail con IVA Retail Price VAT incl.
F264605100BINE	Vetro Glass	Bianco White	1x max 70W E27	Si Yes	Vedi tabella p. 181 See table p. 181	420,00 €
VETRO SOFFIATO BLOWN GLASS				IP20		





Codice Code	Materiale Material	Colore Colour	Sorgente luminosa Light source	Dimmer incluso Dimmer included	Classe energetica Energy label	Prezzo Retail con IVA Retail Price VAT incl.
F264610100BINE	Vetro Glass	○ Bianco White	1x max 100W E27	Si Yes	Vedi tabella p. 181 See table p. 181	720,00 €

 VETRO SOFFIATO BLOWN GLASS
 
 Classe II IP20

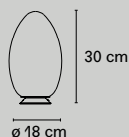
### UOVO RICARICABILE / RECHARGEABLE BEN SWILDENS 1972



Codice Code	Materiale Material	Colore Colour	Sorgente luminosa Light source	Dimmer incluso Dimmer included	Classe energetica Energy label	Prezzo Retail con IVA Retail Price VAT incl.
F264600150BIBW	Vetro, Metallo Glass, Metal	○ Bianco White	LED 2,2W (250Lm)	Si Yes	F	395,00 €



 VETRO SOFFIATO BLOWN GLASS
 
 IP54

LED integrato Integrated LED  
 durata 8 ore alla massima potenza  
 8 hours duration at maximum power

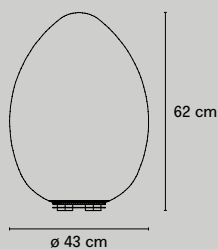
### UOVO INDOOR / OUTDOOR BEN SWILDENS 1972



Codice Code	Materiale Material	Colore Colour	Sorgente luminosa Light source	Dimmer incluso Dimmer included	Classe energetica Energy label	Prezzo Retail con IVA Retail Price VAT incl.
F264613370BINE	Polimero, Metallo Polymer, Metal	○ Bianco White	1x max 30W E27	No	Vedi tabella p. 181 See table p. 181	825,00 €

 VETRO SOFFIATO BLOWN GLASS
 
 Classe II IPX4



**VOLÉE**  
ODO FIORAVANTI  
2015

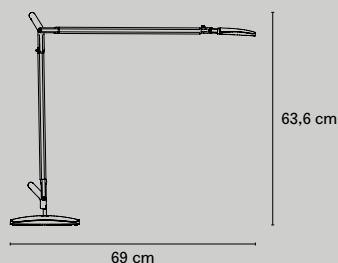

Codice Code	Materiale Material	Colore Colour	Sorgente luminosa Light source	Dimmer incluso Dimmer included	Classe Energetica Energy label	Prezzo Retail con IVA Retail Price VAT incl.
F429005350BIWL	Polimero, Metallo Polymer, Metal	○ Bianco White	LED 7,5W (2700K, CRI>90, 800Lm)	Si, touch Yes, touch	F	450,00 €
F429005350GIWL	Polimero, Metallo Polymer, Metal	● Giallo Yellow	LED 7,5W (2700K, CRI>90, 800Lm)	Si, touch Yes, touch	F	450,00 €
F429005350GSWL	Polimero, Metallo Polymer, Metal	● Grigio scuro Dark gray	LED 7,5W (2700K, CRI>90, 800Lm)	Si, touch Yes, touch	F	450,00 €

LED integrato  
Integrated LED



**DEMI VOLÉE**  
ODO FIORAVANTI  
2015

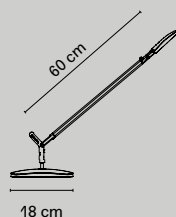

Codice Code	Materiale Material	Colore Colour	Sorgente luminosa Light source	Dimmer incluso Dimmer included	Classe energetica Energy label	Prezzo Retail con IVA Retail Price VAT incl.
F429000350BIWL	Polimero, Metallo Polymer, Metal	○ Bianco White	LED 7,5W (2700K, CRI>90, 800Lm)	Si, touch Yes, touch	F	370,00 €
F429000350GIWL	Polimero, Metallo Polymer, Metal	● Giallo Yellow	LED 7,5W (2700K, CRI>90, 800Lm)	Si, touch Yes, touch	F	370,00 €
F429000350GSWL	Polimero, Metallo Polymer, Metal	● Grigio scuro Dark gray	LED 7,5W (2700K, CRI>90, 800Lm)	Si, touch Yes, touch	F	370,00 €

LED integrato  
Integrated LED





# LAMPADE DA TERRA / FLOOR LAMPS

0024	p. 51	THEA	p. 63
3247	p. 51	TRIPOD	p. 63
ALICANTO	p. 52	VERTIGO	p. 64
BIANCA	p. 53	YUMI	p. 64
CHESHIRE	p. 53		
EQUATORE	p. 54		
FALENA	p. 55		
FLÛTE	p. 55		
GALERIE	p. 56		
LUMEN	p. 57		
LUMINATOR	p. 57		
MERIDIANO	p. 58		
NASKA XL	p. 58		
OORT SISTEMA	p. 59		
PAROLA	p. 60		
PAROLONA	p. 60		
PIRELLONE	p. 61		
PRIMA SIGNORA	p. 61		
RILUMINATOR	p. 62		
SCINTILLA	p. 62		

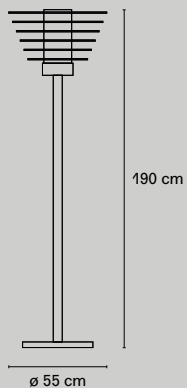

**0024**  
GIO PONTI  
1933



Codice Code	Materiale Material	Colore Colour	Sorgente luminosa Light source	Dimmer incluso Dimmer included	Classe energetica Energy label	Prezzo Retail con IVA Retail Price VAT incl.
F002430150TRNE	Vetro, Metallo Glass, Metal	 Trasparente, Cromo Transparent, Chrome	1x max 205W E27	Si Yes	Vedi tabella p. 181 See table p. 181	2.400,00 €

CE ENEC IP20

**3247**  
HISTORICAL ARCHIVE  
1954

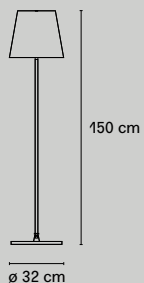



Codice Code	Materiale Material	Colore Colour	Sorgente luminosa Light source	Dimmer incluso Dimmer included	Classe energetica Energy label	Prezzo Retail con IVA Retail Price VAT incl.
F324725150KBNE	Vetro, Metallo Glass, Metal	 Nichel, Bianco Nickel, White	1x max 150W E27	Si Yes	Vedi tabella p. 181 See table p. 181	930,00 €



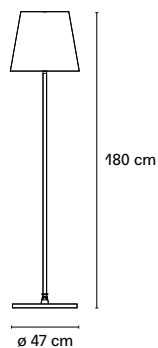

CE ENEC Classe II IP20

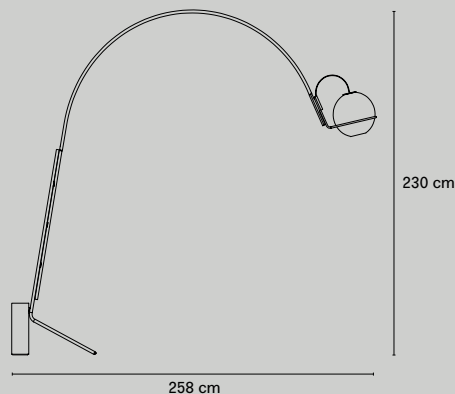

Codice Code	Materiale Material	Colore Colour	Sorgente luminosa Light source	Dimmer incluso Dimmer included	Classe energetica Energy label	Prezzo Retail con IVA Retail Price VAT incl.
F324730150KBNE	Vetro, Metallo Glass, Metal	Nichel, Bianco Nickel, White	4x max 46W E27* + 1x max 100W E27**	*Sì Yes **No	Vedi tabella p. 181 See table p. 181	1.800,00 €
			Doppia accensione Double light controls			

**ALICANTO**  
FRANCESCO LIBRIZZI  
2021



Codice Code	Materiale Material	Colore Colour	Sorgente luminosa Light source	Dimmer incluso Dimmer included	Classe energetica Energy label	Prezzo Retail con IVA Retail Price VAT incl.
F443630160OBWL	Vetro, Metallo Verniciato Glass, Painted Metal	Oro, Bianco Gold, White	LED 17W (3000K, CRI>90, 2430Lm)	Sì Yes	E	3.300,00 €
F443630160ONWL	Vetro, Metallo Verniciato Glass, Painted Metal	Oro, Nero Gold, Black	LED 17W (3000K, CRI>90, 2430Lm)	Sì Yes	E	3.300,00 €
			LED integrato Integrated LED			
			Su richiesta tecnologia Casambi e 2700K Casambi technology and 2700K on request			

**BIANCA**  
MATTI KLENELL  
2015



177,5 cm

ø 50 cm



Codice Code	Materiale Material	Colore Colour	Sorgente luminosa Light source	Dimmer incluso Dimmer included	Classe energetica Energy label	Prezzo Retail con IVA Retail Price VAT incl.
F430930150BINE	Vetro, Metallo Glass, Metal	○ Bianco White	1x max 116W E27	Si Yes	Vedi tabella p. 181 See table p. 181	1.100,00 €



CE ENEC Classe II  
IP20

**CHESHIRE**  
GAMFRATESI  
2013



145 cm

ø 35 cm







Codice Code	Materiale Material	Colore Colour	Sorgente luminosa Light source	Dimmer incluso Dimmer included	Classe energetica Energy label	Prezzo Retail con IVA Retail Price VAT incl.
F425225350BINE	Polimero, Metallo Polymer, Metal	○ Bianco White	3x max 23W E27	No	Vedi tabella p. 181 See table p. 181	630,00 €
F425225350NENE	Polimero, Metallo Polymer, Metal	● Nero Black	3x max 23W E27	No	Vedi tabella p. 181 See table p. 181	630,00 €

CE ENEC Intertek IP40

**EQUATORE**  
GABRIELE E OSCAR BURATTI  
2017



Codice Code	Materiale Material	Colore Colour	Sorgente luminosa Light source	Dimmer incluso Dimmer included	Classe energetica Energy label	Prezzo Retail con IVA Retail Price VAT incl.
F439220550CRWL	Vetro, Metallo Galvanizzato Glass, Galvanized Metal	 Cromo Chrome	LED 25W (2700K, CRI>90, 2900Lm)	Si Yes	F	1.540,00 €
F439220550NEWL	Vetro, Metallo Galvanizzato Glass, Galvanized Metal	 Nero lucido Glossy black	LED 25W (2700K, CRI>90, 2900Lm)	Si Yes	F	1.540,00 €
F439220150OOWL	Vetro, Metallo Glass, Metal	 Oro opaco Matt gold	LED 25W (2700K, CRI>90, 2900Lm)	Si Yes	F	1.380,00 €
F439220550RSWL	Vetro, Metallo Galvanizzato Glass, Galvanized Metal	 Rame lucido Glossy copper	LED 25W (2700K, CRI>90, 2900Lm)	Si Yes	F	1.540,00 €







LED integrato  
Integrated LED

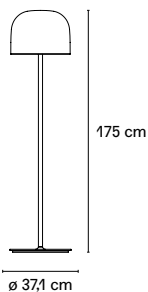

Possibilità di acquisto con tecnologia Dali o Casambi su richiesta  
Dali or Casambi technology on request



Codice Code	Materiale Material	Colore Colour	Sorgente luminosa Light source	Dimmer incluso Dimmer included	Classe energetica Energy label	Prezzo Retail con IVA Retail Price VAT incl.
F439225550CRWL	Vetro, Metallo Galvanizzato Glass, Galvanized Metal	 Cromo Chrome	LED 40W (2700K, CRI>90, 4500Lm)	Si Yes	F	2.310,00 €
F439225550NEWL	Vetro, Metallo Galvanizzato Glass, Galvanized Metal	 Nero lucido Glossy black	LED 40W (2700K, CRI>90, 4500Lm)	Si Yes	F	2.310,00 €
F439225150OOWL	Vetro, Metallo Glass, Metal	 Oro opaco Matt gold	LED 40W (2700K, CRI>90, 4500Lm)	Si Yes	F	2.420,00 €
F439225550RSWL	Vetro, Metallo Galvanizzato Glass, Galvanized Metal	 Rame lucido Glossy copper	LED 40W (2700K, CRI>90, 4500Lm)	Si Yes	F	2.310,00 €



LED integrato  
Integrated LED



Possibilità di acquisto con tecnologia Dali o Casambi su richiesta  
Dali or Casambi technology on request

**FALENA**  
ALVARO SIZA  
1994

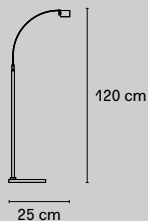

Codice Code	Materiale Material	Colore Colour	Sorgente luminosa Light source	Dimmer incluso Dimmer included	Classe energetica Energy label	Prezzo Retail con IVA Retail Price VAT incl.
F301825150CRNE	Vetro, Metallo Glass, Metal	Cromo Chrome	1x max 50W GY6.35	No	Vedi tabella p. 181 See table p. 181	845,00 €

CE ENEC Classe II IP20

**FLÔTE**  
FRANCO RAGGI  
1999

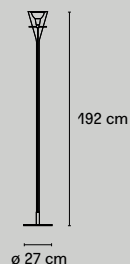

Codice Code	Materiale Material	Colore Colour	Sorgente luminosa Light source	Dimmer incluso Dimmer included	Classe energetica Energy label	Prezzo Retail con IVA Retail Price VAT incl.
F330025150TCNE	Vetro, Metallo Glass, Metal	Trasparente, Cromo Transparent, Chrome	1x max 205W E27	Sì Yes	Vedi tabella p. 181 See table p. 181	1.450,00 €



VETRO SOFFIATO  
BLOWN GLASS

CE ENEC Classe II IP20

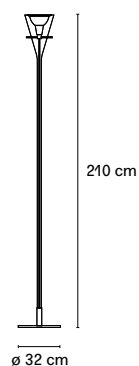

Codice Code	Materiale Material	Colore Colour	Sorgente luminosa Light source	Dimmer incluso Dimmer included	Classe energetica Energy label	Prezzo Retail con IVA Retail Price VAT incl.
F330030150TCNE	Vetro, Metallo Glass, Metal	Trasparente, Cromo Transparent, Chrome	1x max 230W R7s/115	Sì Yes	Vedi tabella p. 181 See table p. 181	2.800,00 €



VETRO SOFFIATO  
BLOWN GLASS

CE ENEC IP20



**GALERIE**  
**FEDERICO PERI**  
**2017**

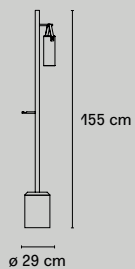

Codice Code	Materiale Material	Colore Colour	Sorgente luminosa Light source	Dimmer incluso Dimmer included	Classe energetica Energy label	Prezzo Retail con IVA Retail Price VAT incl.
F440025500QZWL	Vetro, Metallo, Marmo Glass, Metal, Marble	Oro rosa, Bianco Rose gold, White	LED 6W (2700K, CRI>80, 850Lm)	Si Yes	E	2.150,00 €
VETRO SOFFIATO BLOWN GLASS			LED integrato Integrated LED	<small>Classe III</small> IP20		

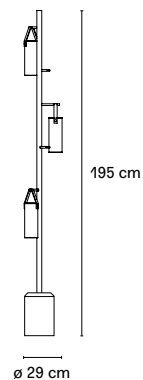

Codice Code	Materiale Material	Colore Colour	Sorgente luminosa Light source	Dimmer incluso Dimmer included	Classe energetica Energy label	Prezzo Retail con IVA Retail Price VAT incl.
F447630500QZWL	Vetro, Metallo, Marmo Glass, Metal, Marble	Oro rosa, Bianco Rose gold, White	LED 3x6W (2700K, CRI>80, 3x850Lm)	Si Yes	E	3.300,00 €
VETRO SOFFIATO BLOWN GLASS			LED integrato Integrated LED	<small>Classe III</small> IP20		

**LUMEN**  
HISTORICAL ARCHIVE  
1954

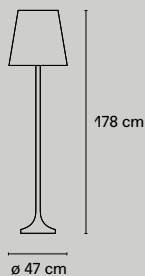

Codice Code	Materiale Material	Colore Colour	Sorgente luminosa Light source	Dimmer incluso Dimmer included	Classe energetica Energy label	Prezzo Retail con IVA Retail Price VAT incl.
F248225150BINE	Vetro, Metallo Glass, Metal	<input type="radio"/> Bianco White	4x max 46W E27* + 1x max 100W E27**	*Si Yes **No	Vedi tabella p. 181 See table p. 181	1.980,00 €



Doppia accensione  
Double light controls



**LUMINATOR**  
PIETRO CHIESA  
1933

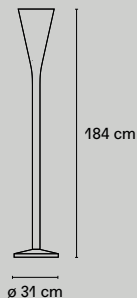

Codice Code	Materiale Material	Colore Colour	Sorgente luminosa Light source	Dimmer incluso Dimmer included	Classe energetica Energy label	Prezzo Retail con IVA Retail Price VAT incl.
F005630200NSWL	Metallo Metal	<input type="radio"/> Nichel Nickel	LED 30W (3000K, CRI>80, 3000Lm)	Si Yes	G	2.500,00 €
F005630210BIWL	Metallo Verniciato Painted Metal	<input type="radio"/> Bianco White	LED 30W (3000K, CRI>80, 3000Lm)	Si Yes	G	2.500,00 €
F005630210BLWL	Metallo Verniciato Painted Metal	<input type="radio"/> Blu Blue	LED 30W (3000K, CRI>80, 3000Lm)	Si Yes	G	2.500,00 €

LED integrato  
Integrated LED



Su richiesta con  
tecnologia Casambi  
Casambi technology on  
request

**MERIDIANO**  
GABRIELE E OSCAR BURATTI  
2020



Codice Code	Materiale Material	Colore Colour	Sorgente luminosa Light source	Dimmer incluso Dimmer included	Classe energetica Energy label	Prezzo Retail con IVA Retail Price VAT incl.
F441725550NFWL	Vetro, Metallo Galvanizzato Glass, Galvanized Metal	● Nero, Fumè Black, Grey fumè	LED 25W (2700K, CRI>90, 2900Lm) + LED 8W (2700K, 1180Lm)	Si Yes	F	2.200,00 €
F441725550NRWL	Vetro, Metallo Galvanizzato Glass, Galvanized Metal	● Nero, Rosa Black, Pink	LED 25W (2700K, CRI>90, 2900Lm) + LED 8W (2700K, 1180Lm)	Si Yes	F	2.200,00 €
F441725550NTWL	Vetro, Metallo Galvanizzato Glass, Galvanized Metal	● Nero, Trasparente Black, Transparent	LED 25W (2700K, CRI>90, 2900Lm) + LED 8W (2700K, 1180Lm)	Si Yes	F	2.200,00 €
			LED integrato Integrated LED	CE <small>Class II</small> IP20		
			Su richiesta tecnologia Dali o Casambi Dali or Casambi technology on request			



**NASKA XL**  
HISTORICAL ARCHIVE  
1933

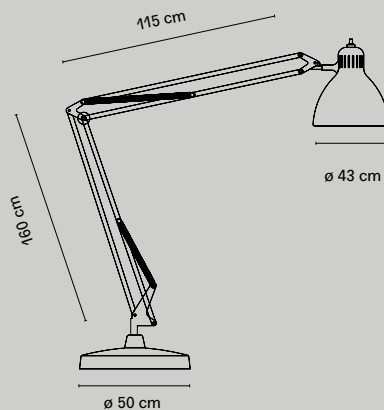

Codice Code	Materiale Material	Colore Colour	Sorgente luminosa Light source	Dimmer incluso Dimmer included	Classe energetica Energy label	Prezzo Retail con IVA Retail Price VAT incl.
F810525200BINE	Metallo Verniciato Painted Metal	○ Bianco White	1x max 42W E27	Si Yes	Vedi tabella p. 181 See table p. 181	3.200,00 €
F810525200NENE	Metallo Verniciato Painted Metal	● Nero Black	1x max 42W E27	Si Yes	Vedi tabella p. 181 See table p. 181	3.200,00 €



**OORT SISTEMA**  
**JACOPO RODA**  
**2022**

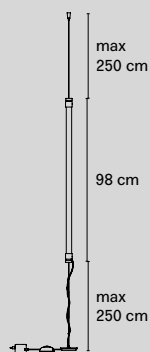

Codice Code	Materiale Material	Colore Colour	Sorgente luminosa Light source	Dimmer incluso Dimmer included	Classe energetica Energy label	Prezzo Retail con IVA Retail Price VAT incl.
OORT00001	Vetro, Metallo Galvanizzato Glass, Galvanized Metal	● Nichel nero Nickel black	LED 18W (3000K, 1700Lm)	Si, Yes	G	660,00 €
OORT00010	Vetro, Metallo Galvanizzato Glass, Galvanized Metal	● Nichel nero Nickel black	LED 18W (DTW da 1800K a 4000K)	Si, Yes	G	720,00 €

LED integrato  
Integrated LED



Su richiesta tecnologia  
Casambi e 2700K  
Casambi technology and  
2700K on request

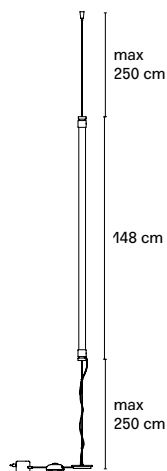

Codice Code	Materiale Material	Colore Colour	Sorgente luminosa Light source	Dimmer incluso Dimmer included	Classe energetica Energy label	Prezzo Retail con IVA Retail Price VAT incl.
OORT00002	Vetro, Metallo Galvanizzato Glass, Galvanized Metal	● Nichel nero Nickel black	LED 28W (3000K, 2660Lm)	Si, Yes	G	740,00 €
OORT00011	Vetro, Metallo Galvanizzato Glass, Galvanized Metal	● Nichel nero Nickel black	LED 28W (DTW da 1800K a 4000K)	Si, Yes	G	810,00 €



LED integrato  
Integrated LED

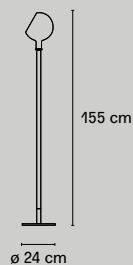

Su richiesta tecnologia  
Casambi e 2700K  
Casambi technology and  
2700K on request

**PAROLA**  
GAE AULENTI  
E PIERO CASTIGLIONI  
1980





Codice Code	Materiale Material	Colore Colour	Sorgente luminosa Light source	Dimmer incluso Dimmer included	Classe energetica Energy label	Prezzo Retail con IVA Retail Price VAT incl.
F265925100AMNE	Vetro Glass	 Ambra Amber	1x max 60W E14	Si Yes	Vedi tabella p. 181 See table p. 181	1.050,00 €
F265925100BINE	Vetro Glass	 Bianco White	1x max 60W E14	Si Yes	Vedi tabella p. 181 See table p. 181	1.050,00 €

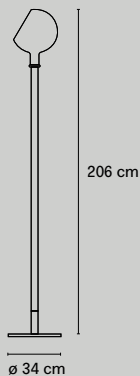

CE ENEC IP20

**PAROLONA**  
GAE AULENTI  
E PIERO CASTIGLIONI  
1980





Codice Code	Materiale Material	Colore Colour	Sorgente luminosa Light source	Dimmer incluso Dimmer included	Classe energetica Energy label	Prezzo Retail con IVA Retail Price VAT incl.
F275130150BINE	Vetro Glass	 Bianco White	1x max 60W E14	Si Yes	Vedi tabella p. 181 See table p. 181	1.300,00 €

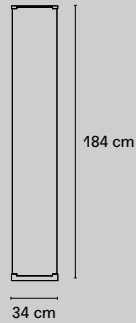

CE ENEC IP20

**PIRELLONE**  
GIO PONTI  
1967





Codice Code	Materiale Material	Colore Colour	Sorgente luminosa Light source	Dimmer incluso Dimmer included	Classe energetica Energy label	Prezzo Retail con IVA Retail Price VAT incl.
F275930150KBNE	Vetro, Metallo Glass, Metal	 Nichel, Bianco Nickel, White	10x max 33W G9 + 1x max 230W R7s/115*	*Sì Yes	Vedi tabella p. 181 See table p. 181	2.800,00 €

Doppia accensione  
Double light controls

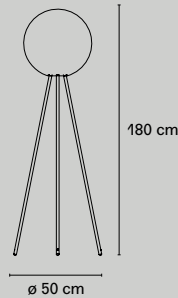

**PRIMA SIGNORA**  
DANIELA PUPPA  
1992



Codice Code	Materiale Material	Colore Colour	Sorgente luminosa Light source	Dimmer incluso Dimmer included	Classe energetica Energy label	Prezzo Retail con IVA Retail Price VAT incl.
F289130150CBNE	Vetro, Metallo Glass, Metal	 Cromo, Bianco Chrome, White	1x max 205W E27	Sì Yes	Vedi tabella p. 181 See table p. 181	1.350,00 €



**RILUMINATOR**  
PIETRO CHIESA  
2014

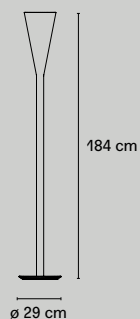

Codice Code	Materiale Material	Colore Colour	Sorgente luminosa Light source	Dimmer incluso Dimmer included	Classe energetica Energy label	Prezzo Retail con IVA Retail Price VAT incl.
F425930350BIWL	Polimero, Metallo Polymer, Metal	○ Bianco White	LED 30W (3000K, CRI>80, 3000Lm)	Si Yes	G	1.430,00 €
			LED integrato Integrated LED	CE ENEC <small>Classe #</small> IP20		
			Su richiesta con tecnologia Casambi Casambi technology on request			

**SCINTILLA**  
LIVIO E PIERO CASTIGLIONI  
1972



Codice Code	Materiale Material	Colore Colour	Sorgente luminosa Light source	Dimmer incluso Dimmer included	Classe energetica Energy label	Prezzo Retail con IVA Retail Price VAT incl.
F272930250CRNE	Metallo, Vetro Metal, Glass	● Cromo Chrome	1x max 230W R7s/115	Si Yes	Vedi tabella p. 181 See table p. 181	1.000,00 €
F272930250NSNE	Metallo, Vetro Metal, Glass	● Nichel satinato Satin nickel	1x max 230W R7s/115	Si Yes	Vedi tabella p. 181 See table p. 181	1.000,00 €

CE ENEC IP20

**THEA**  
GABRIELE E OSCAR BURATTI  
2022

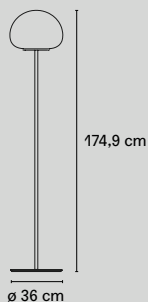

Codice Code	Materiale Material	Colore Colour	Sorgente luminosa Light source	Dimmer incluso Dimmer included	Classe energetica Energy label	Prezzo Retail con IVA Retail Price VAT incl.
F444930550NFWL	Vetro, Metallo Galvanizzato Glass, Galvanized Metal	Nero lucido, Fumè Glossy black, Grey fumè	LED 11,6W (3000K, CRI>90, 1596Lm)	Si Yes	F	1.800,00 €
F444930575RTWL	Vetro, Metallo Galvanizzato Glass, Galvanized Metal	Rame lucido, Trasparente Glossy copper, Transparent	LED 11,6W (3000K, CRI>90, 1596Lm)	Si Yes	F	1.800,00 €



LED integrato  
Integrated LED



Su richiesta tecnologia  
Casambi  
Casambi technology on  
request

**TRIPOD**  
FRONT DESIGN  
2017

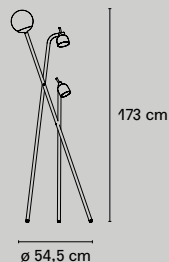

Codice Code	Materiale Material	Colore Colour	Sorgente luminosa Light source	Dimmer incluso Dimmer included	Classe energetica Energy label	Prezzo Retail con IVA Retail Price VAT incl.
F439825150NENE	Vetro, Metallo Glass, Metal	Nero, Ottone Black, Brass	1x max 105W E27* + 2x max 70W GU10	*Si Yes	Vedi tabella p. 181 See table p. 181	1.980,00 €





Doppia accensione  
Double light controls



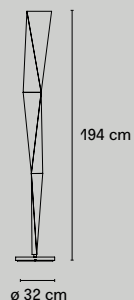

**VERTIGO**  
MARCO ACERBIS  
2005



Codice Code	Materiale Material	Colore Colour	Sorgente luminosa Light source	Dimmer incluso Dimmer included	Classe energetica Energy label	Prezzo Retail con IVA Retail Price VAT incl.
F553130240CRWL	Metallo Metal	 Acciaio Steel	LED 30W (3000K, CRI>80, 3000Lm)	Si Yes	G	2.280,00 €



LED integrato  
Integrated LED

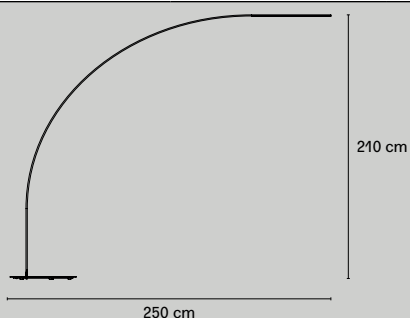

Su richiesta tecnologia  
Casambi  
Casambi technology on  
request

**YUMI**  
SHIGERU BAN  
2011



Codice Code	Materiale Material	Colore Colour	Sorgente luminosa Light source	Dimmer incluso Dimmer included	Classe energetica Energy label	Prezzo Retail con IVA Retail Price VAT incl.
F414330200BIWL	Metallo Metal	 Bianco White	LED 240x22W (2700K, CRI>80, 2400Lm)	Si Yes	F	2.180,00 €
F414330200NEWL	Metallo Metal	 Nero Black	LED 240x22W (2700K, CRI>80, 2400Lm)	Si Yes	F	2.180,00 €

LED integrato  
Integrated LED



Su richiesta tecnologia  
Casambi  
Casambi technology on  
request

# LAMPADE A PARETE / WALL LAMPS

ALICANTO	p. 67	SOLE	p. 80
APEX	p. 68	THEA	p. 80
BIANCA	p. 68	TROPICO	p. 81
BONNET	p. 69		
BRUCO	p. 69		
FALENA	p. 69		
FLEX	p. 70		
FONTANELLA	p. 70		
FRENESI	p. 71		
GALERIE	p. 71		
IO	p. 71		
LUNAIRE	p. 72		
NASKA	p. 73		
NOBI	p. 74		
OORT SISTEMA	p. 75		
PALLINA	p. 75		
PAROLA	p. 76		
RIGA	p. 76		
SCINTILLA	p. 77		
SILLABA	p. 78		
SILLABONE	p. 79		



**ALICANTO**  
FRANCESCO LIBRIZZI  
2021

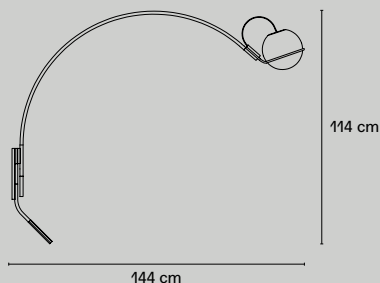

Codice Code	Materiale Material	Colore Colour	Sorgente luminosa Light source	Dimmerabile Dimmable	Classe energetica Energy label	Prezzo Retail con IVA Retail Price VAT incl.
-------------	--------------------	---------------	--------------------------------	----------------------	--------------------------------	--

F443645160NEWL	Vetro, Metallo Verniciato Glass, Painted Metal	● Nero Black	LED 8W (3000K, CRI>90, 1180Lm)	Si Yes	F	1.600,00 €
----------------	---	-----------------	-----------------------------------	-----------	---	------------



LED integrato  
Integrated LED



Su richiesta tecnologia  
Casambi e 2700K  
Casambi technology and  
2700K on request

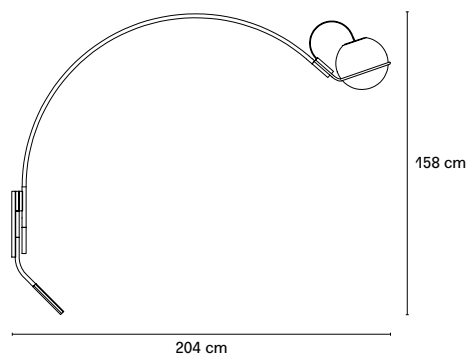

Codice Code	Materiale Material	Colore Colour	Sorgente luminosa Light source	Dimmerabile Dimmable	Classe energetica Energy label	Prezzo Retail con IVA Retail Price VAT incl.
-------------	--------------------	---------------	--------------------------------	----------------------	--------------------------------	--

F443650160NEWL	Vetro, Metallo Verniciato Glass, Painted Metal	● Nero Black	LED 8W (3000K, CRI>90, 1180Lm)	Si Yes	F	1.700,00 €
----------------	---	-----------------	-----------------------------------	-----------	---	------------



LED integrato  
Integrated LED



Su richiesta tecnologia  
Casambi e 2700K  
Casambi technology and  
2700K on request

**APEX**  
**KARIM RASHID**  
**2015**

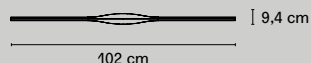

Codice Code	Materiale Material	Colore Colour	Sorgente luminosa Light source	Dimmerabile Dimmable	Classe energetica Energy label	Prezzo Retail con IVA Retail Price VAT incl.
F431145200BILE	Metallo Metal	Bianco White	LED 2x7W (2700K, CRI>80, 2x900Lm)	Si, 1-10V Yes, 1-10V	F	510,00 €
F431145200NELE	Metallo Metal	Nero Black	LED 2x7W (2700K, CRI>80, 2x900Lm)	Si, 1-10V Yes, 1-10V	F	510,00 €
			LED integrato Integrated LED			

**BIANCA**  
**MATTI KLENELL**  
**2015**

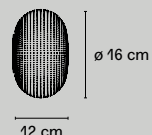

Codice Code	Materiale Material	Colore Colour	Sorgente luminosa Light source	Dimmerabile Dimmable	Classe energetica Energy label	Prezzo Retail con IVA Retail Price VAT incl.
F432860150BILE	Vetro, Metallo Glass, Metal	Bianco White	LED 4,5W (2700K, CRI>80, 350Lm)	Si, taglio di fase Yes, phase cut dimmer	F	325,00 €
			LED integrato Integrated LED			

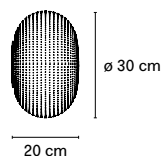

Codice Code	Materiale Material	Colore Colour	Sorgente luminosa Light source	Dimmerabile Dimmable	Classe energetica Energy label	Prezzo Retail con IVA Retail Price VAT incl.
F432865150BILE	Vetro, Metallo Glass, Metal	Bianco White	LED 17,5W (2700K, CRI>80, 1650Lm)	Si, TRIAC Yes, TRIAC	E	520,00 €
			LED integrato Integrated LED			

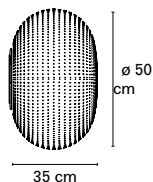

Codice Code	Materiale Material	Colore Colour	Sorgente luminosa Light source	Dimmerabile Dimmable	Classe energetica Energy label	Prezzo Retail con IVA Retail Price VAT incl.
F432870150BINE	Vetro, Metallo Glass, Metal	Bianco White	1x max 116W E27	Si Yes	Vedi tabella p. 181 See table p. 181	730,00 €



**BONNET**  
ODO FIORAVANTI  
2014

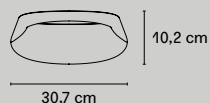

Codice Code	Materiale Material	Colore Colour	Sorgente luminosa Light source	Dimmerabile Dimmable	Classe energetica Energy label	Prezzo Retail con IVA Retail Price VAT incl.
F443245200BILE	Metallo Metal	○ Bianco White	LED 18W (2700K, CRI>80, 2300Lm)	Si, trailing edge Yes, trailing edge	E	330,00 €
F443345200BILE	Metallo Metal	○ Bianco White	LED 18W (3000K, CRI>80, 2300Lm)	Si, trailing edge Yes, trailing edge	D	330,00 €

LED integrato Integrated LED

CE ENEC IP20

**BRUCO**  
VICO MAGISTRETTI  
2003

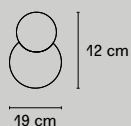

Codice Code	Materiale Material	Colore Colour	Sorgente luminosa Light source	Dimmerabile Dimmable	Classe energetica Energy label	Prezzo Retail con IVA Retail Price VAT incl.
F353845100BINE	Vetro Glass	○ Bianco White	1x max 46W E14	Si Yes	Vedi tabella p. 181 See table p. 181	290,00 €

VETRO SOFFIATO BLOWN GLASS

CE ENEC IP40

**FALENA**  
ALVARO SIZA  
1994

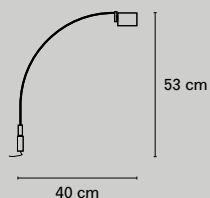

Codice Code	Materiale Material	Colore Colour	Sorgente luminosa Light source	Dimmerabile Dimmable	Classe energetica Energy label	Prezzo Retail con IVA Retail Price VAT incl.
F301945150CRNE	Vetro, Metallo Glass, Metal	● Cromo Chrome	1x max 50W GY6.35	No	Vedi tabella p. 181 See table p. 181	515,00 €

CE ENEC Classe II IP20

**FLEX**  
KARIM RASHID  
2015

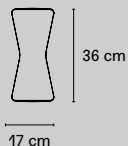

Codice Code	Materiale Material	Colore Colour	Sorgente luminosa Light source	Dimmerabile Dimmable	Classe energetica Energy label	Prezzo Retail con IVA Retail Price VAT incl.
F431045200BILE	Vetro, Metallo Glass, Metall	○ Bianco White	LED 2x13W (3000K, CRI>80, 2x1350Lm)	Si, 1-10V Yes, 1-10V	E	345,00 €
F431045200NELE	Vetro, Metallo Glass, Metall	● Nero Black	LED 2x13W (3000K, CRI>80, 2x1350Lm)	Si, 1-10V Yes, 1-10V	E	345,00 €



**FONTANELLA**  
FEDERICO PERI  
2020

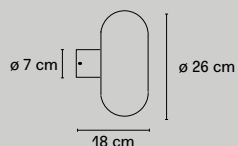

Codice Code	Materiale Material	Colore Colour	Sorgente luminosa Light source	Dimmerabile Dimmable	Classe energetica Energy label	Prezzo Retail con IVA Retail Price VAT incl.
F447745550CRNE	Vetro, Metallo Galvanizzato Glass, Galvanized Metal	● Cromo Chrome	1x max 28W E14	Si Yes	Vedi tabella p. 181 See table p. 181	525,00 €
F447745550NENE	Vetro, Metallo Galvanizzato Glass, Galvanized Metal	● Nero lucido Glossy black	1x max 28W E14	Si Yes	Vedi tabella p. 181 See table p. 181	525,00 €
F447745550OTNE	Vetro, Metallo Galvanizzato Glass, Galvanized Metal	● Ottone lucido Glossy Brass	1x max 28W E14	Si Yes	Vedi tabella p. 181 See table p. 181	545,00 €

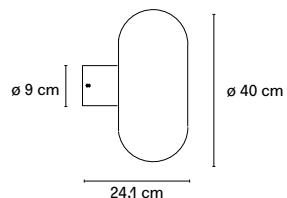



Codice Code	Materiale Material	Colore Colour	Sorgente luminosa Light source	Dimmerabile Dimmable	Classe energetica Energy label	Prezzo Retail con IVA Retail Price VAT incl.
F447750550CRNE	Vetro, Metallo Galvanizzato Glass, Galvanized Metal	● Cromo Chrome	1x max 77W E27	Si Yes	Vedi tabella p. 181 See table p. 181	785,00 €
F447750550NENE	Vetro, Metallo Galvanizzato Glass, Galvanized Metal	● Nero lucido Glossy black	1x max 77W E27	Si Yes	Vedi tabella p. 181 See table p. 181	785,00 €
F447750550OTNE	Vetro, Metallo Galvanizzato Glass, Galvanized Metal	● Ottone lucido Glossy Brass	1x max 77W E27	Si Yes	Vedi tabella p. 181 See table p. 181	805,00 €



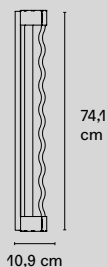



**FRENESI**  
STUDIOLUCAGUADAGNINO  
2022

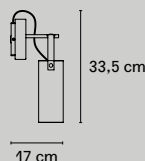

Codice Code	Materiale Material	Colore Colour	Sorgente luminosa Light source	Dimmerabile Dimmable	Classe energetica Energy label	Prezzo Retail con IVA Retail Price VAT incl.
F446745550TCLE	Vetro, Metallo Glass, Metal	 Trasparente, Cromo Transparent, Chrome	LED 2x7W (2700K, CRI>90, 1550Lm)	Si, a taglio di fase Yes, phase cut dimmer	G	2.100,00 €
LED integrato Integrated LED				 IP40		

**GALERIE**  
FEDERICO PERI  
2017







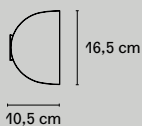

Codice Code	Materiale Material	Colore Colour	Sorgente luminosa Light source	Dimmerabile Dimmable	Classe energetica Energy label	Prezzo Retail con IVA Retail Price VAT incl.
F439945500QZLE	Vetro, Metallo, Marmo Glass, Metal, Marble	 Oro rosa, Bianco Rose gold, White	LED 8W (2700K, CRI>80, 1000Lm)	Si, TRIAC Yes, TRIAC	E	950,00 €
LED integrato Integrated LED				   IP20		



**IO**  
CLAESSON  
KOIVISTO RUNE  
2015



Codice Code	Materiale Material	Colore Colour	Sorgente luminosa Light source	Dimmerabile Dimmable	Classe energetica Energy label	Prezzo retail Retail price
F429945200BILE	Metallo Metal	 Bianco White	LED 2x4,5W (2700K, CRI>90, 2x350Lm)	Si, TRIAC Yes, TRIAC	F	290,00 €
F429945200BLLE	Metallo Metal	 Blu Blue	LED 2x4,5W (2700K, CRI>90, 2x350Lm)	Si, TRIAC Yes, TRIAC	F	340,00 €
F429945200GSLE	Metallo Metal	 Grigio Scuro Dark gray	LED 2x4,5W (2700K, CRI>90, 2x350Lm)	Si, TRIAC Yes, TRIAC	F	340,00 €
F429945200ROLE	Metallo Metal	 Rosso Red	LED 2x4,5W (2700K, CRI>90, 2x350Lm)	Si, TRIAC Yes, TRIAC	F	340,00 €
LED integrato Integrated LED				   IP40		



**LUNAIRE**  
**FERRÉOL BABIN**  
**2013**

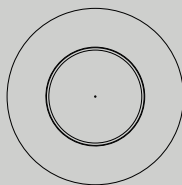

ø 75 cm

Codice Code	Materiale Material	Colore Colour	Sorgente luminosa Light source	Dimmerabile Dimmable	Classe energetica Energy label	Prezzo Retail con IVA Retail Price VAT incl.
F424665350BILE	Polimero, Metallo Verniciato Polymer, Painted Metal	○ Bianco White	LED 28,6W (3000K, CRI>80, 3650Lm)	No	E	990,00 €
F424665350NELE	Polimero, Metallo Verniciato Polymer, Painted Metal	◐ Nero, Bianco Black, White	LED 28,6W (3000K, CRI>80, 3650Lm)	No	E	990,00 €
F424665360RNLE	Polimero, Metallo Verniciato Polymer, Painted Metal	◑ Rame, Nero Copper, Black	LED 28,6W (3000K, CRI>80, 3650Lm)	No	E	1.990,00 €
F424665360ONLE	Polimero, Metallo Verniciato Polymer, Painted Metal	◒ Oro, Nero Gold, Black	LED 28,6W (3000K, CRI>80, 3650Lm)	No	E	1.990,00 €
F424665370RMLE	Polimero, Metallo Verniciato Polymer, Painted Metal	◒ Rame Copper	LED 28,6W (3000K, CRI>80, 3650Lm)	No	E	2.200,00 €
F424665370OOLE	Polimero, Metallo Verniciato Polymer, Painted Metal	◒ Oro Gold	LED 28,6W (3000K, CRI>80, 3650Lm)	No	E	2.200,00 €

LED integrato  
Integrated LED

CE ENEC IP40

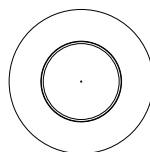

ø 50 cm



Codice Code	Materiale Material	Colore Colour	Sorgente luminosa Light source	Dimmerabile Dimmable	Classe energetica Energy label	Prezzo Retail con IVA Retail Price VAT incl.
F424660350BILE	Polimero, Metallo Verniciato Polymer, Painted Metal	○ Bianco White	LED 10W (2700K, CRI 80, 1250Lm)	Si, TRIAC Yes, TRIAC	F	650,00 €

LED integrato  
Integrated LED

CE ENEC IP20

**NASKA**  
HISTORICAL ARCHIVE  
1933

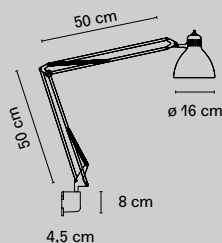

Codice Code	Materiale Material	Colore Colour	Sorgente luminosa Light source	Dimmerabile Dimmable	Classe energetica Energy label	Prezzo Retail con IVA Retail Price VAT incl.
F810350200BINE	Metallo Verniciato Painted Metal	○ Bianco White	1x max 46W E27	No	Vedi tabella p. 181 See table p. 181	440,00 €
F810350240CRNE	Metallo Galvanizzato Galvanized Metal	◐ Cromo Chrome	1x max 46W E27	No	Vedi tabella p. 181 See table p. 181	510,00 €
F810350200NENE	Metallo Verniciato Painted Metal	● Nero Black	1x max 46W E27	No	Vedi tabella p. 181 See table p. 181	440,00 €

CE ENEC Classe III IP20

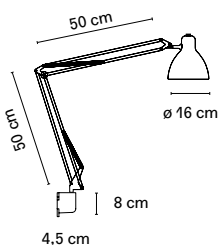

Codice Code	Materiale Material	Colore Colour	Sorgente luminosa Light source	Dimmerabile Dimmable	Classe energetica Energy label	Prezzo Retail con IVA Retail Price VAT incl.
F810350200BIWL	Metallo Verniciato Painted Metal	○ Bianco White	LED 6W (2700K, CRI>80, 800Lm)	Si, touch Yes, touch	F	485,00 €
F810350240CRWL	Metallo Galvanizzato Galvanized Metal	◐ Cromo Chrome	LED 6W (2700K, CRI>80, 800Lm)	Si, touch Yes, touch	F	580,00 €
F810350200NEWL	Metallo Verniciato Painted Metal	● Nero Black	LED 6W (2700K, CRI>80, 800Lm)	Si, touch Yes, touch	F	485,00 €
F810350240OOWL	Metallo Galvanizzato Galvanized Metal	◑ Oro, Nero Gold, Black	LED 6W (2700K, CRI>80, 800Lm)	Si, touch Yes, touch	F	580,00 €

LED integrato Integrated LED

CE ENEC Classe III IP20

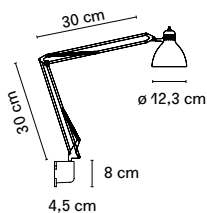

Codice Code	Materiale Material	Colore Colour	Sorgente luminosa Light source	Dimmerabile Dimmable	Classe energetica Energy label	Prezzo Retail con IVA Retail Price VAT incl.
F810340200BINE	Metallo Verniciato Painted Metal	○ Bianco White	1x max 46W E27	No	Vedi tabella p. 181 See table p. 181	430,00 €
F810340240CRNE	Metallo Galvanizzato Galvanized Metal	● Cromo Chrome	1x max 46W E27	No	Vedi tabella p. 181 See table p. 181	490,00 €
F810340200NENE	Metallo Verniciato Painted Metal	● Nero Black	1x max 46W E27	No	Vedi tabella p. 181 See table p. 181	430,00 €



## NOBI METIS LIGHTING 1992

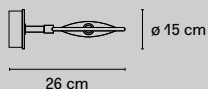

Codice Code	Materiale Material	Colore Colour	Sorgente luminosa Light source	Dimmerabile Dimmable	Classe energetica Energy label	Prezzo Retail con IVA Retail Price VAT incl.
F302345150BINE	Vetro, Metallo Glass, Metall	○ Bianco White	1x max 120W R7s/80	Si Yes	Vedi tabella p. 181 See table p. 181	350,00 €

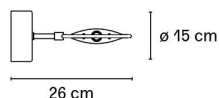

Codice Code	Materiale Material	Colore Colour	Sorgente luminosa Light source	Dimmerabile Dimmable	Classe energetica Energy label	Prezzo Retail con IVA Retail Price VAT incl.
F302345150CRLE	Vetro, Metallo Glass, Metall	● Cromo Chrome	LED 14W (2700K, CRI>80, 1400Lm)	Si, 1-10V Yes, 1-10V	F	470,00 €
F302345150NSLE	Vetro, Metallo Glass, Metall	● Nichel satinato Satin nickel	LED 14W (2700K, CRI>80, 1400Lm)	Si, 1-10V Yes, 1-10V	F	470,00 €

LED integrato  
Integrated LED



**OORT SISTEMA**  
**JACOPO RODA**  
**2022**

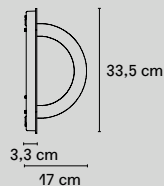

Codice Code	Materiale Material	Colore Colour	Sorgente luminosa Light source	Dimmerabile Dimmable	Classe energetica Energy label	Prezzo Retail con IVA Retail Price VAT incl.
OORT00030	Vetro, Metallo Glass, Metal	Bianco, Specchio White, Mirror	LED 8W (3000K, 760Lm)	Si, 1-10V/PUSH Yes, 1-10V/PUSH	G	460,00 €
OORT00031	Vetro, Metallo Glass, Metal	Bianco, Specchio White, Mirror	LED 8W (DTW da 1800K a 4000K)	Si, 1-10V/PUSH Yes, 1-10V/PUSH	G	490,00 €
LED integrato Integrated LED				<b>CE</b> IP20*		
Su richiesta 2700K 2700K on request				*su richiesta IP44 dimmerabile Triac dimmable Triac IP44 on request		

**PALLINA**  
**FONTANAARTE DESIGN LAB**  
**2019**

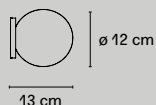

Codice Code	Materiale Material	Colore Colour	Sorgente luminosa Light source	Dimmerabile Dimmable	Classe energetica Energy label	Prezzo Retail con IVA Retail Price VAT incl.
F443060150NENE	Vetro, Metallo Galvanizzato Glass, Galvanized Metal	Nero lucido Glossy black	1x max 6W G9	Si Yes	Vedi tabella p. 181 See table p. 181	275,00 €
F443060150NSNE	Vetro, Metallo Galvanizzato Glass, Galvanized Metal	Nichel lucido Glossy nickel	1x max 6W G9	Si Yes	Vedi tabella p. 181 See table p. 181	275,00 €
F443060150OTNE	Vetro, Metallo Galvanizzato Glass, Galvanized Metal	Ottone lucido Glossy brass	1x max 6W G9	Si Yes	Vedi tabella p. 181 See table p. 181	275,00 €
F443060150ORNE	Vetro, Metallo Verniciato Glass, Painted Metal	Oro rosa Rose gold	1x max 6W G9	Si Yes	Vedi tabella p. 181 See table p. 181	300,00 €



**PAROLA**  
GAE AULENTI  
E PIERO CASTIGLIONI  
1980

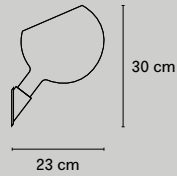

Codice Code	Materiale Material	Colore Colour	Sorgente luminosa Light source	Dimmerabile Dimmable	Classe energetica Energy label	Prezzo Retail con IVA Retail Price VAT incl.
F268945150AMNE	Vetro Glass	Ambra Amber	1x max 46W E14	Si Yes	Vedi tabella p. 181 See table p. 181	730,00 €
F268945150BINE	Vetro Glass	Bianco White	1x max 46W E14	Si Yes	Vedi tabella p. 181 See table p. 181	730,00 €

**RIGA**  
PAOLO ZANI  
1995

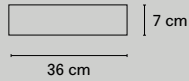

Codice Code	Materiale Material	Colore Colour	Sorgente luminosa Light source	Dimmerabile Dimmable	Classe energetica Energy label	Prezzo Retail con IVA Retail Price VAT incl.
F521440260AXLE	Vetro, Metallo Glass, Metall	Acciaio Steel	LED 2x9W (3000K, CRI>80, 2x850Lm)	Si, a taglio di fase Yes, phase cut dimmer	E	400,00 €
F521440250BILE	Vetro, Metallo Glass, Metall	Bianco White	LED 2x9W (3000K, CRI>80, 2x850Lm)	Si, a taglio di fase Yes, phase cut dimmer	E	360,00 €
F521440260NSLE	Vetro, Metallo Glass, Metall	Nichel satinato Satin nickel	LED 2x9W (3000K, CRI>80, 2x850Lm)	Si, a taglio di fase Yes, phase cut dimmer	E	400,00 €

LED integrato Integrated LED

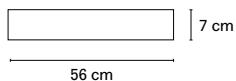

Codice Code	Materiale Material	Colore Colour	Sorgente luminosa Light source	Dimmerabile Dimmable	Classe energetica Energy label	Prezzo Retail con IVA Retail Price VAT incl.
F539845260AXLE	Vetro, Metallo Glass, Metall	Acciaio Steel	LED 2x9W (3000K, CRI>80, 2x850Lm)	Si, a taglio di fase Yes, phase cut dimmer	E	450,00 €
F539845250BILE	Vetro, Metallo Glass, Metall	Bianco White	LED 2x9W (3000K, CRI>80, 2x850Lm)	Si, a taglio di fase Yes, phase cut dimmer	E	410,00 €
F539845260NSLE	Vetro, Metallo Glass, Metall	Nichel satinato Satin nickel	LED 2x9W (3000K, CRI>80, 2x850Lm)	Si, a taglio di fase Yes, phase cut dimmer	E	450,00 €
LED integrato Integrated LED						

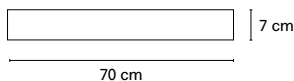

Codice Code	Materiale Material	Colore Colour	Sorgente luminosa Light source	Dimmerabile Dimmable	Classe energetica Energy label	Prezzo Retail con IVA Retail Price VAT incl.
F521450260AXLE	Vetro, Metallo Glass, Metall	Acciaio Steel	LED 2x9,5W (3000K, CRI>80, 2x910Lm)	Si, a taglio di fase Yes, phase cut dimmer	E	560,00 €
F521450250BILE	Vetro, Metallo Glass, Metall	Bianco White	LED 2x9,5W (3000K, CRI>80, 2x910Lm)	Si, a taglio di fase Yes, phase cut dimmer	E	520,00 €
F521450260NSLE	Vetro, Metallo Glass, Metall	Nichel satinato Satin nickel	LED 2x9,5W (3000K, CRI>80, 2x910Lm)	Si, a taglio di fase Yes, phase cut dimmer	E	560,00 €
LED integrato Integrated LED						

## SCINTILLA LIVIO E PIERO CASTIGLIONI 1972

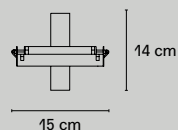

Codice Code	Materiale Material	Colore Colour	Sorgente luminosa Light source	Dimmerabile Dimmable	Classe energetica Energy label	Prezzo Retail con IVA Retail Price VAT incl.
FP15045250CRNE	Vetro, Metallo Glass, Metall	Cromo Chrome	1x max 120W R7s/80	Si Yes	Vedi tabella p. 181 See table p. 181	300,00 €
FP15045250NSNE	Vetro, Metallo Glass, Metall	Nichel satinato Satin nickel	1x max 120W R7s/80	Si Yes	Vedi tabella p. 181 See table p. 181	300,00 €



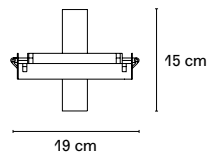

Codice Code	Materiale Material	Colore Colour	Sorgente luminosa Light source	Dimmerabile Dimmable	Classe energetica Energy label	Prezzo Retail con IVA Retail Price VAT incl.
FP30050250CRNE	Vetro, Metallo Glass, Metall	Cromo Chrome	1x max 230W R7s/115	Si Yes	Vedi tabella p. 181 See table p. 181	350,00 €
FP30050250NSNE	Vetro, Metallo Glass, Metall	Nichel satinato Satin nickel	1x max 230W R7s/115	Si Yes	Vedi tabella p. 181 See table p. 181	350,00 €



Codice Code	Materiale Material	Colore Colour	Descrizione Description	Prezzo Retail con IVA Retail Price VAT incl.
RP15000M02AL00	Metallo Metall	Alluminio Aluminum	Riflettore per FP15045250..NE, Reflector for FP15045250..NE	75,00 €
RP30000M02AL00	Metallo Metall	Alluminio Aluminum	Riflettore per FP30050250..NE, Reflector for FP30050250..NE	75,00 €

## SILLABA PIERO CASTIGLIONI 1988

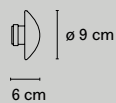

Codice Code	Materiale Material	Colore Colour	Sorgente luminosa Light source	Dimmerabile Dimmable	Classe energetica Energy label	Prezzo Retail con IVA Retail Price VAT incl.
F277560150BINE	Vetro, Metallo Glass, Metall	Bianco White	1x max 20W G4	Si Yes	Vedi tabella p. 181 See table p. 181	130,00 €



Alimentatore non  
incluso  
Ballast not included

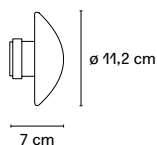

Codice Code	Materiale Material	Colore Colour	Sorgente luminosa Light source	Dimmerabile Dimmable	Classe energetica Energy label	Prezzo Retail con IVA Retail Price VAT incl.
F277565150BINE	Vetro, Metallo Glass, Metall	Bianco White	1x max 50W GY6.35	Si Yes	Vedi tabella p. 181 See table p. 181	200,00 €



Alimentatore non  
incluso  
Ballast not included

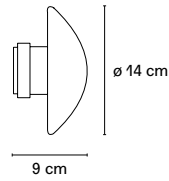

Codice Code	Materiale Material	Colore Colour	Sorgente luminosa Light source	Dimmerabile Dimmable	Classe energetica Energy label	Prezzo Retail con IVA Retail Price VAT incl.
F277570150BINE	Vetro, Metallo Glass, Metall	○ Bianco White	1x max 60W G9	Si Yes	Vedi tabella p. 181 See table p. 181	215,00 €



Codice Code	Materiale Material	Colore Colour	Sorgente luminosa Light source	Dimmerabile Dimmable	Classe energetica Energy label	Prezzo Retail con IVA Retail Price VAT incl.
F277570150BILE	Vetro, Metallo Glass, Metall	○ Bianco White	LED 1x8W (3000K, CRI>80, 650Lm)	Si, a taglio di fase Yes, phase cut dimmer	F	360,00 €

LED integrato  
Integrated LED



**SILLABONE**  
PIERO CASTIGLIONI  
1988

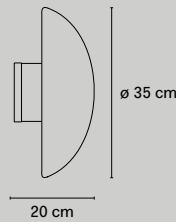

Codice Code	Materiale Material	Colore Colour	Sorgente luminosa Light source	Dimmerabile Dimmable	Classe energetica Energy label	Prezzo Retail con IVA Retail Price VAT incl.
F279370150BINE	Vetro, Metallo Glass, Metall	○ Bianco White	1x max 100W E27	Si Yes	Vedi tabella p. 181 See table p. 181	410,00 €





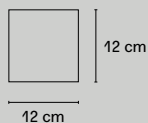

**SOLE**  
BERNARDINO AMATO  
2011

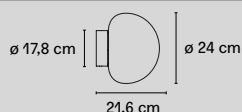

Codice Code	Materiale Material	Colore Colour	Sorgente luminosa Light source	Dimmerabile Dimmable	Classe energetica Energy label	Prezzo Retail con IVA Retail Price VAT incl.
F414040150BILE	Vetro, Polimero Glass, Polymer	○ Bianco White	LED 49x9W (3000K, CRI>85, 800Lm)	Si, TRIAC Yes, TRIAC	D	375,00 €
			LED integrato Integrated LED	CE ENEC Intertek	Classo II IP44	
F413940150BILE	Vetro, Polimero Glass, Polymer	○ Bianco White	LED 49x9W (3000K, CRI>85, 800Lm)	Si, TRIAC Yes, TRIAC	D	2.050,00 €
	Confezione da 6 pz Pack of 6 pcs		LED integrato Integrated LED	CE ENEC Intertek	Classo II IP44	

**THEA**  
GABRIELE E OSCAR BURATTI  
2022



Codice Code	Materiale Material	Colore Colour	Sorgente luminosa Light source	Dimmerabile Dimmable	Classe energetica Energy label	Prezzo Retail con IVA Retail Price VAT incl.
F444965550NFLE	Vetro, Metallo Galvanizzato Glass, Galvanized Metal	● Nero lucido, Fumè Glossy black, Grey fumè	LED 3,85W (3000K, CRI>90, 640Lm)	Si, TRIAC Yes, TRIAC	F	920,00 €
F444965575RTLE	Vetro, Metallo Galvanizzato Glass, Galvanized Metal	● Rame lucido, Trasparente Glossy copper, Transparent	LED 3,85W (3000K, CRI>90, 640Lm)	Si, TRIAC Yes, TRIAC	F	920,00 €
	 VETRO SOFFIATO BLOWN GLASS		LED integrato Integrated LED	CE IP40		
F444970550NFLE	Vetro, Metallo Galvanizzato Glass, Galvanized Metal	● Nero lucido, Fumè Glossy black, Grey fumè	LED 11,6W (3000K, CRI>90, 1596Lm)	Si, 1-10V/PUSH Yes, 1-10V/PUSH	F	1.540,00 €
F444970575RTLE	Vetro, Metallo Galvanizzato Glass, Galvanized Metal	● Rame lucido, Trasparente Glossy copper, Transparent	LED 11,6W (3000K, CRI>90, 1596Lm)	Si, 1-10V/PUSH Yes, 1-10V/PUSH	F	1.540,00 €
	 VETRO SOFFIATO BLOWN GLASS		LED integrato Integrated LED	CE IP40		

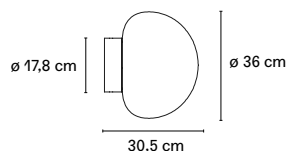

**TROPICO**  
GABRIELE E OSCAR BURATTI  
2020

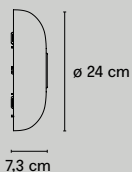

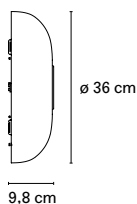

Codice Code	Materiale Material	Colore Colour	Sorgente luminosa Light source	Dimmerabile Dimmable	Classe energetica Energy label	Prezzo Retail con IVA Retail Price VAT incl.
F442160550NELE	Vetro, Metallo Galvanizzato Glass, Galvanized Metall	Nero lucido Glossy black	LED 20,5W (3000K, CRI>80, 2200Lm)	Sì, a taglio di fase Yes, phase cut dimmer	F	470,00 €
F442160550OOLE	Vetro, Metallo Galvanizzato Glass, Galvanized Metal	Oro lucido Glossy gold	LED 20,5W (3000K, CRI>80, 2200Lm)	Sì, a taglio di fase Yes, phase cut dimmer	F	470,00 €
VETRO SOFFIATO BLOWN GLASS			LED integrato Integrated LED	IP20		

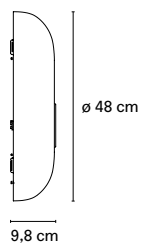

Codice Code	Materiale Material	Colore Colour	Sorgente luminosa Light source	Dimmerabile Dimmable	Classe energetica Energy label	Prezzo Retail con IVA Retail Price VAT incl.
F442165550NELE	Vetro, Metallo Galvanizzato Glass, Galvanized Metall	Nero lucido Glossy black	LED 30,5W (3000K, CRI>80, 3000Lm)	Sì, a taglio di fase Yes, phase cut dimmer	E	590,00 €
F442165550OOLE	Vetro, Metallo Galvanizzato Glass, Galvanized Metal	Oro lucido Glossy gold	LED 30,5W (3000K, CRI>80, 3000Lm)	Sì, a taglio di fase Yes, phase cut dimmer	E	590,00 €
VETRO SOFFIATO BLOWN GLASS			LED integrato Integrated LED	IP20		



Codice Code	Materiale Material	Colore Colour	Sorgente luminosa Light source	Dimmerabile Dimmable	Classe energetica Energy label	Prezzo Retail con IVA Retail Price VAT incl.
F442170550NELE	Vetro, Metallo Galvanizzato Glass, Galvanized Metall	● Nero lucido Glossy black	LED 42,5W (3000K, CRI>80, 4600Lm)	Si, a taglio di fase F Yes, phase cut dimmer	F	780,00 €
F442170550OOLE	Vetro, Metallo Galvanizzato Glass, Galvanized Metal	● Oro lucido Glossy gold	LED 42,5W (3000K, CRI>80, 4600Lm)	Si, a taglio di fase F Yes, phase cut dimmer	F	780,00 €
			LED integrato Integrated LED			

**KIT CASAMBI**  
R442100K05BI00

Casambi è un dispositivo intelligente, non è necessaria una connessione Internet ma è sufficiente attivare il Bluetooth del telefono o tablet o altri dispositivi di controllo e scaricare la App gratuita grazie alla quale le lampade potranno venire accese, spente e regolate di intensità a seconda dello scenario che si desidera nel proprio ambiente.

Casambi is an intelligent device, no Internet connection is required, simply activate the Bluetooth on your phone, tablet or other control device and download the free App to turn the lamps on and off and adjust their intensity according to the scenario you want to create in your environment.

156,00 €

# LAMPADE A PLAFONE / CEILING LAMPS

BIANCA	p. 85
FONTANELLA	p. 86
FRENESI	p. 87
LUNAIRE	p. 87
OORT SISTEMA	p. 87
PALLINA	p. 88
PANGEN	p. 89
SILLABA	p. 89
SILLABONE	p. 90
SOLE	p. 90
THEA	p. 91
TROPICO	p. 92



**BIANCA**  
MATTI KLENELL  
2015



12 cm

ø 16 cm



Codice Code	Materiale Material	Colore Colour	Sorgente luminosa Light source	Dimmerabile Dimmable	Classe energetica Energy label	Prezzo Retail con IVA Retail Price VAT incl.
F432860150BILE	Vetro, Metallo Glass, Metal	○ Bianco White	LED 4,5W (2700K, CRI>80, 350Lm)	Si, taglio di fase Yes, phase cut dimmer	F	325,00 €



LED integrato Integrated LED

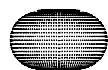

20 cm

ø 30 cm

Codice Code	Materiale Material	Colore Colour	Sorgente luminosa Light source	Dimmerabile Dimmable	Classe energetica Energy label	Prezzo Retail con IVA Retail Price VAT incl.
F432865150BILE	Vetro, Metallo Glass, Metal	○ Bianco White	LED 17,5W (2700K, CRI>80, 1650Lm)	Si, TRIAC Yes, TRIAC	E	520,00 €



LED integrato Integrated LED



35 cm



ø 50 cm

Codice Code	Materiale Material	Colore Colour	Sorgente luminosa Light source	Dimmerabile Dimmable	Classe energetica Energy label	Prezzo Retail con IVA Retail Price VAT incl.
F432870150BINE	Vetro, Metallo Glass, Metal	○ Bianco White	1x max 116W E27	Si Yes	Vedi tabella p. 181 See table p. 181	730,00 €

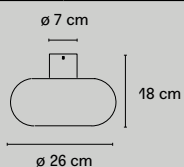

**FONTANELLA**  
**FEDERICO PERI**  
**2020**





Codice Code	Materiale Material	Colore Colour	Sorgente luminosa Light source	Dimmerabile Dimmable	Classe energetica Energy label	Prezzo Retail con IVA Retail Price VAT incl.
F447745550CRNE	Vetro, Metallo Galvanizzato Glass, Galvanized Metal	 Cromo Chrome	1x max 28W E14	Si Yes	Vedi tabella p. 181 See table p. 181	525,00 €
F447745550NENE	Vetro, Metallo Galvanizzato Glass, Galvanized Metal	 Nero lucido Glossy black	1x max 28W E14	Si Yes	Vedi tabella p. 181 See table p. 181	525,00 €
F447745550OTNE	Vetro, Metallo Galvanizzato Glass, Galvanized Metal	 Ottone lucido Glossy Brass	1x max 28W E14	Si Yes	Vedi tabella p. 181 See table p. 181	545,00 €

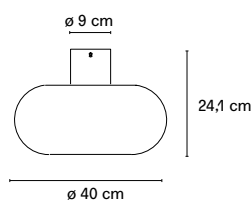

CE IP20



Codice Code	Materiale Material	Colore Colour	Sorgente luminosa Light source	Dimmerabile Dimmable	Classe energetica Energy label	Prezzo Retail con IVA Retail Price VAT incl.
F447750550CRNE	Vetro, Metallo Galvanizzato Glass, Galvanized Metal	 Cromo Chrome	1x max 77W E27	Si Yes	Vedi tabella p. 181 See table p. 181	785,00 €
F447750550NENE	Vetro, Metallo Galvanizzato Glass, Galvanized Metal	 Nero lucido Glossy black	1x max 77W E27	Si Yes	Vedi tabella p. 181 See table p. 181	785,00 €
F447750550OTNE	Vetro, Metallo Galvanizzato Glass, Galvanized Metal	 Ottone lucido Glossy Brass	1x max 77W E27	Si Yes	Vedi tabella p. 181 See table p. 181	805,00 €



CE IP20

## FRENESI STUDIOLUCAGUADAGNINO 2022

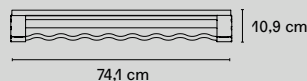

Codice Code	Materiale Material	Colore Colour	Sorgente luminosa Light source	Dimmerabile Dimmable	Classe energetica Energy label	Prezzo Retail con IVA Retail Price VAT incl.
F446745550TCLE	Vetro, Metallo Glass, Metal	Trasparente, Cromo Transparent, Chrome	LED 2x7W (2700K, CRI>90, 1550Lm)	Sì, a taglio di fase Yes, phase cut dimmer	G	2.100,00 €
LED integrato Integrated LED				CE IP40		

## LUNAIRE FERRÉOL BABIN 2013

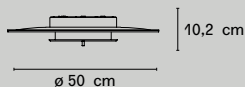

Codice Code	Materiale Material	Colore Colour	Sorgente luminosa Light source	Dimmerabile Dimmable	Classe energetica Energy label	Prezzo Retail con IVA Retail Price VAT incl.
F424660350BILE	Polimero, Metallo Verniciato Polymer, Painted Metal	Bianco White	LED 10W (2700K, CRI 80, 1250Lm)	No	E	650,00 €
LED integrato Integrated LED				CE ENEC IP20		





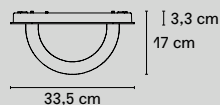

## OORT SISTEMA JACOPO RODA 2022

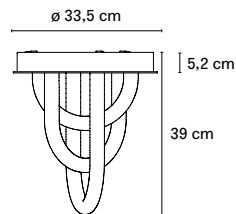

Codice Code	Materiale Material	Colore Colour	Sorgente luminosa Light source	Dimmerabile Dimmable	Classe energetica Energy label	Prezzo Retail con IVA Retail Price VAT incl.
OORT00030	Vetro, Metallo Glass, Metal	Bianco, Specchio White, Mirror	LED 8W (3000K, 760Lm)	Sì, 1-10V/PUSH Yes, 1-10V/PUSH	G	460,00 €
OORT00031	Vetro, Metallo Glass, Metal	Bianco, Specchio White, Mirror	LED 8W (DTW da 1800K a 4000K)	Sì, 1-10V/PUSH Yes, 1-10V/PUSH	G	490,00 €
LED integrato Integrated LED				CE IP20*		
Su richiesta 2700K 2700K on request				*su richiesta IP44 dimmerabile Triac dimmable Triac IP44 on request		







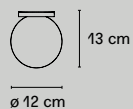

Codice Code	Materiale Material	Colore Colour	Sorgente luminosa Light source	Dimmerabile Dimmable	Classe energetica Energy label	Prezzo Retail con IVA Retail Price VAT incl.
OORT00040	Vetro, Metallo Glass, Metal	 Bianco, Specchio White, Mirror	LED 8W + 12W + 16W (3000K, 3400Lm)	Si, 1-10V/PUSH Yes, 1-10V/PUSH	G	1.240,00 €
OORT00041	Vetro, Metallo Glass, Metal	 Bianco, Specchio White, Mirror	LED 8W + 12W + 16W (DTW da 1800K a 4000K)	Si, 1-10V/PUSH Yes, 1-10V/PUSH	G	1.330,00 €
			LED integrato Integrated LED	 IP20		
			Su richiedi 2700K 2700K on request			

## PALLINA FONTANAARTE DESIGN LAB 2019



Codice Code	Materiale Material	Colore Colour	Sorgente luminosa Light source	Dimmerabile Dimmable	Classe energetica Energy label	Prezzo Retail con IVA Retail Price VAT incl.
F443060150NENE	Vetro, Metallo Galvanizzato Glass, Galvanized Metal	 Nero lucido Glossy black	1x max 6W G9	Si Yes	Vedi tabella p. 181 See table p. 181	275,00 €
F443060150NSNE	Vetro, Metallo Galvanizzato Glass, Galvanized Metal	 Nichel lucido Glossy nickel	1x max 6W G9	Si Yes	Vedi tabella p. 181 See table p. 181	275,00 €
F443060150OTNE	Vetro, Metallo Galvanizzato Glass, Galvanized Metal	 Ottone lucido Glossy brass	1x max 6W G9	Si Yes	Vedi tabella p. 181 See table p. 181	275,00 €
F443060150ORNE	Vetro, Metallo Verniciato Glass, Painted Metal	 Oro rosa Rose gold	1x max 6W G9	Si Yes	Vedi tabella p. 181 See table p. 181	300,00 €



**PANGEN**  
HISTORICAL ARCHIVE  
1969

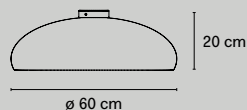

Codice Code	Materiale Material	Colore Colour	Sorgente luminosa Light source	Dimmerabile Dimmable	Classe energetica Energy label	Prezzo Retail con IVA Retail Price VAT incl.
F419766350BINE	Polimero, Metallo Polymer, Metal	○ Bianco White	3x max 46W E27	Si Yes	Vedi tabella p. 181 See table p. 181	820,00 €
F419766350NENE	Polimero, Metallo Polymer, Metal	● Nero Black	3x max 46W E27	Si Yes	Vedi tabella p. 181 See table p. 181	820,00 €
F419766350RONE	Polimero, Metallo Polymer, Metal	● Rosso red	3x max 46W E27	Si Yes	Vedi tabella p. 181 See table p. 181	820,00 €

CE ENEC IP20

**SILLABA**  
PIERO CASTIGLIONI  
1988

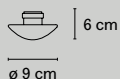

Codice Code	Materiale Material	Colore Colour	Sorgente luminosa Light source	Dimmerabile Dimmable	Classe energetica Energy label	Prezzo Retail con IVA Retail Price VAT incl.
F277560150BINE	Vetro, Metallo Glass, Metal	○ Bianco White	1x max 20W G4	Si Yes	Vedi tabella p. 181 See table p. 181	130,00 €

CE ENEC Ineretek Classe III IP44

Alimentatore non  
incluso  
Ballast not included

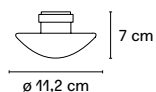

Codice Code	Materiale Material	Colore Colour	Sorgente luminosa Light source	Dimmerabile Dimmable	Classe energetica Energy label	Prezzo Retail con IVA Retail Price VAT incl.
F277565150BINE	Vetro, Metallo Glass, Metal	○ Bianco White	1x max 50W GY6.35	Si Yes	Vedi tabella p. 181 See table p. 181	200,00 €

CE ENEC Ineretek Classe III IP44

Alimentatore non  
incluso  
Ballast not included

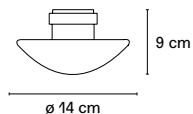

Codice Code	Materiale Material	Colore Colour	Sorgente luminosa Light source	Dimmerabile Dimmable	Classe energetica Energy label	Prezzo Retail con IVA Retail Price VAT incl.
F277570150BINE	Vetro, Metallo Glass, Metall	○ Bianco White	1x max 60W G9	Si Yes	Vedi tabella p. 181 See table p. 181	215,00 €



Codice Code	Materiale Material	Colore Colour	Sorgente luminosa Light source	Dimmerabile Dimmable	Classe energetica Energy label	Prezzo Retail con IVA Retail Price VAT incl.
F277570150BILE	Vetro, Metallo Glass, Metall	○ Bianco White	LED 1x8W (3000K, CRI>80, 650Lm)	Si, a taglio di fase Yes, phase cut dimmer	F	360,00 €

LED integrato  
Integrated LED



### SILLABONE PIERO CASTIGLIONI 1988

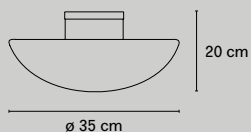

Codice Code	Materiale Material	Colore Colour	Sorgente luminosa Light source	Dimmerabile Dimmable	Classe energetica Energy label	Prezzo Retail con IVA Retail Price VAT incl.
F279370150BINE	Vetro, Metallo Glass, Metall	○ Bianco White	1x max 100W E27	Si Yes	Vedi tabella p. 181 See table p. 181	410,00 €



### SOLE BERNARDINO AMATO 2011

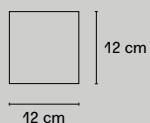

Codice Code	Materiale Material	Colore Colour	Sorgente luminosa Light source	Dimmerabile Dimmable	Classe energetica Energy label	Prezzo Retail con IVA Retail Price VAT incl.
F414040150BILE	Vetro, Polimero Glass, Polymer	○ Bianco White	LED 49x9W (3000K, CRI>85, 800Lm)	Si, TRIAC Yes, TRIAC	D	375,00 €

LED integrato  
Integrated LED



Codice Code	Materiale Material	Colore Colour	Sorgente luminosa Light source	Dimmerabile Dimmable	Classe energetica Energy label	Prezzo Retail con IVA Retail Price VAT incl.
F413940150BILE	Vetro, Polimero Glass, Polymer	○ Bianco White	LED 49x9W (3000K, CRI>85, 800Lm)	Si, TRIAC Yes, TRIAC	D	2.050,00 €
Confezione da 6 pz Pack of 6 pcs			LED integrato Integrated LED	CE ENEC Intertek	Classe # IP44	

**THEA**  
GABRIELE E OSCAR BURATTI  
2022

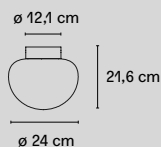

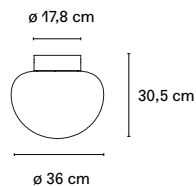

Codice Code	Materiale Material	Colore Colour	Sorgente luminosa Light source	Dimmerabile Dimmable	Classe energetica Energy label	Prezzo Retail con IVA Retail Price VAT incl.
F444965550NFLE	Vetro, Metallo Galvanizzato Glass, Galvanized Metal	● Nero lucido, Fumè Glossy black, Grey fumè	LED 3,85W (3000K, CRI>90, 640Lm)	Si, TRIAC Yes, TRIAC	F	920,00 €
F444965575RTLE	Vetro, Metallo Galvanizzato Glass, Galvanized Metal	● Rame lucido, Trasparente Glossy copper, Transparent	LED 3,85W (3000K, CRI>90, 640Lm)	Si, TRIAC Yes, TRIAC	F	920,00 €
			LED integrato Integrated LED	CE IP40		



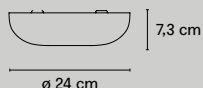

Codice Code	Materiale Material	Colore Colour	Sorgente luminosa Light source	Dimmerabile Dimmable	Classe energetica Energy label	Prezzo Retail con IVA Retail Price VAT incl.
F444970550NFLE	Vetro, Metallo Galvanizzato Glass, Galvanized Metal	● Nero lucido, Fumè Glossy black, Grey fumè	LED 11,6W (3000K, CRI>90, 1596Lm)	Si, 1-10V/PUSH Yes, 1-10V/PUSH	F	1.540,00 €
F444970575RTLE	Vetro, Metallo Galvanizzato Glass, Galvanized Metal	● Rame lucido, Trasparente Glossy copper, Transparent	LED 11,6W (3000K, CRI>90, 1596Lm)	Si, 1-10V/PUSH Yes, 1-10V/PUSH	F	1.540,00 €
			LED integrato Integrated LED	CE IP40		

**TROPICO**  
GABRIELE E OSCAR BURATTI  
2020

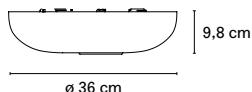

Codice Code	Materiale Material	Colore Colour	Sorgente luminosa Light source	Dimmerabile Dimmable	Classe energetica Energy label	Prezzo Retail con IVA Retail Price VAT incl.
F442160550NELE	Vetro, Metallo Galvanizzato Glass, Galvanized Metall	● Nero lucido Glossy black	LED 20,5W (3000K, CRI>80, 2200Lm)	Si, a taglio di fase Yes, phase cut dimmer	F	470,00 €
F442160550OOLE	Vetro, Metallo Galvanizzato Glass, Galvanized Metall	● Oro lucido Glossy gold	LED 20,5W (3000K, CRI>80, 2200Lm)	Si, a taglio di fase Yes, phase cut dimmer	F	470,00 €
 VETRO SOFFIATO BLOWN GLASS			LED integrato Integrated LED	CE	IP20	



Codice Code	Materiale Material	Colore Colour	Sorgente luminosa Light source	Dimmerabile Dimmable	Classe energetica Energy label	Prezzo Retail con IVA Retail Price VAT incl.
F442165550NELE	Vetro, Metallo Galvanizzato Glass, Galvanized Metall	● Nero lucido Glossy black	LED 30,5W (3000K, CRI>80, 3000Lm)	Si, a taglio di fase Yes, phase cut dimmer	E	590,00 €
F442165550OOLE	Vetro, Metallo Galvanizzato Glass, Galvanized Metall	● Oro lucido Glossy gold	LED 30,5W (3000K, CRI>80, 3000Lm)	Si, a taglio di fase Yes, phase cut dimmer	E	590,00 €
 VETRO SOFFIATO BLOWN GLASS			LED integrato Integrated LED	CE	IP20	

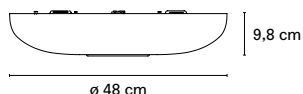

Codice Code	Materiale Material	Colore Colour	Sorgente luminosa Light source	Dimmerabile Dimmable	Classe energetica Energy label	Prezzo Retail con IVA Retail Price VAT incl.
F442170550NELE	Vetro, Metallo Galvanizzato Glass, Galvanized Metall	● Nero lucido Glossy black	LED 42,5W (3000K, CRI>80, 4600Lm)	Si, a taglio di fase Yes, phase cut dimmer	F	780,00 €
F442170550OOLE	Vetro, Metallo Galvanizzato Glass, Galvanized Metall	● Oro lucido Glossy gold	LED 42,5W (3000K, CRI>80, 4600Lm)	Si, a taglio di fase Yes, phase cut dimmer	F	780,00 €
 VETRO SOFFIATO BLOWN GLASS			LED integrato Integrated LED	CE	IP20	

**KIT CASAMBI**  
R442100K05BI00

Casambi è un dispositivo intelligente, non è necessaria una connessione Internet ma è sufficiente attivare il Bluetooth del telefono o tablet o altri dispositivi di controllo e scaricare la App gratuita grazie alla quale le lampade potranno venire accese, spente e regolate di intensità a seconda dello scenario che si desidera nel proprio ambiente.

Casambi is an intelligent device, no Internet connection is required, simply activate the Bluetooth on your phone, tablet or other control device and download the free App to turn the lamps on and off and adjust their intensity according to the scenario you want to create in your environment.

165,00 €

# LAMPADE A SOSPENSIONE / SUSPENSION LAMPS

0024	p. 95	SERPENTINE	p. 120
AMAX	p. 96	SETAREH	p. 120
AVICO	p. 98	THEA	p. 125
BIANCA	p. 99	TUTTI	p. 126
BOLLA	p. 100	UOVO	p. 130
CHANDELIER	p. 101		
CHESHIRE	p. 102		
EQUATORE	p. 103		
FONTANELLA	p. 104		
FLÛTE	p. 105		
GLOBO DI LUCE	p. 107		
HUNA	p. 109		
LAMPARA	p. 109		
MERIDIANO	p. 110		
OORT SISTEMA	p. 112		
PALLINA	p. 116		
PANGEN	p. 116		
PAROLA	p. 117		
PINECONE	p. 117		
SCINTILLA	p. 119		



**0024**  
GIO PONTI  
1933

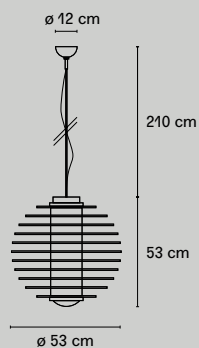

Codice Code	Materiale Material	Colore Colour	Sorgente luminosa Light source	Dimmerabile Dimmable	Classe energetica Energy label	Prezzo Retail con IVA Retail Price VAT incl.
F002485150TRNE	Vetro, Metallo Glass, Metal	Trasparente Transparent	2x max 36W 2G11	No	Vedi tabella p. 181 See table p. 181	2.550,00 €

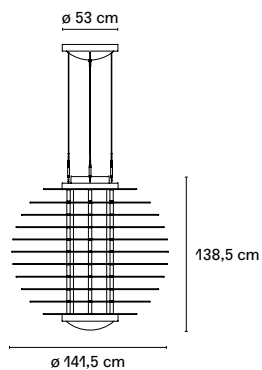

Codice Code	Materiale Material	Colore Colour	Sorgente luminosa Light source	Dimmerabile Dimmable	Classe energetica Energy label	Prezzo Retail con IVA Retail Price VAT incl.
S0024.....	Vetro, Metallo Glass, Metal	Trasparente Transparent	4x max 54W G5	Sì, DALI Yes, DALI	Vedi tabella p. 181 See table p. 181	SU RICHIESTA ON REQUEST

Rosone e cavi, non  
inclusi nel prezzo  
Ceiling rose and cables,  
not included in the price





**AMAX**  
CHARLES WILLIAMS  
2003

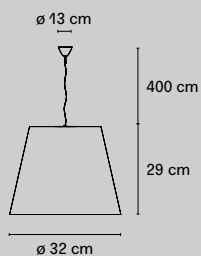

Codice Code	Materiale Material	Colore Colour	Sorgente luminosa Light source	Dimmerabile Dimmable	Classe energetica Energy label	Prezzo Retail con IVA Retail Price VAT incl.
F544480350BINE	Polimero, Metallo Polymer, Metal	○ Bianco White	1x max 100W E27	Si Yes	Vedi tabella p. 181 See table p. 181	490,00 €

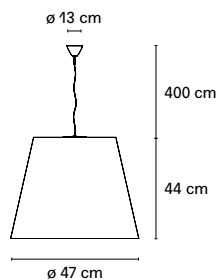

Codice Code	Materiale Material	Colore Colour	Sorgente luminosa Light source	Dimmerabile Dimmable	Classe energetica Energy label	Prezzo Retail con IVA Retail Price VAT incl.
F544485350BINE	Polimero, Metallo Polymer, Metal	○ Bianco White	1x max 150W E27	Si Yes	Vedi tabella p. 181 See table p. 181	660,00 €

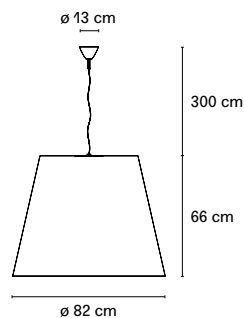

Codice Code	Materiale Material	Colore Colour	Sorgente luminosa Light source	Dimmerabile Dimmable	Classe energetica Energy label	Prezzo Retail con IVA Retail Price VAT incl.
F544490350BINE	Polimero, Metallo Polymer, Metal	○ Bianco White	3x max 100W E27	Si Yes	Vedi tabella p. 181 See table p. 181	1.100,00 €



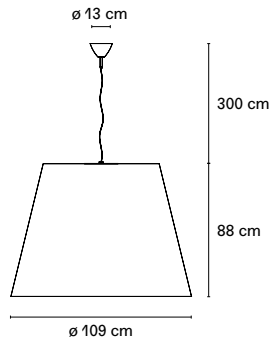

Codice Code	Materiale Material	Colore Colour	Sorgente luminosa Light source	Dimmerabile Dimmable	Classe energetica Energy label	Prezzo Retail con IVA Retail Price VAT incl.
F544495350BINE	Polimero, Metallo Polymer, Metal	○ Bianco White	3x max 150W E27	Si Yes	Vedi tabella p. 181 See table p. 181	1.600,00 €

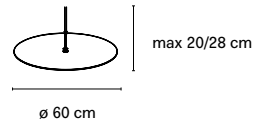

Codice Code	Materiale Material	Colore Colour	Descrizione Description	Prezzo Retail con IVA Retail Price VAT incl.
R556201K00CB00	Polimero, Metallo Polymer, Metall	◐ Cromo, Bianco Chrome, White	Disco di chiusura con tige telescopica per F544490350BINE Closing disk with telescopic stem for F544490350BINE	445,00 €

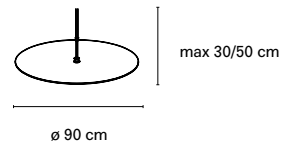

Codice Code	Materiale Material	Colore Colour	Descrizione Description	Prezzo Retail con IVA Retail Price VAT incl.
R556200K00CB00	Polimero, Metallo Polymer, Metall	◐ Cromo, Bianco Chrome, White	Disco di chiusura con tige telescopica per F544495350BINE Closing disk with telescopic stem for F544495350BINE	545,00 €

**AVICO**  
CHARLES WILLIAMS  
2006

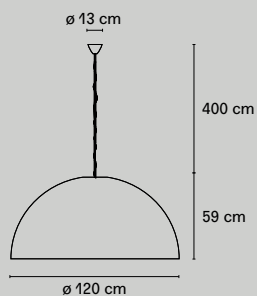

Codice Code	Materiale Material	Colore Colour	Sorgente luminosa Light source	Dimmerabile Dimmable	Classe energetica Energy label	Prezzo Retail con IVA Retail Price VAT incl.
F556180350BINE	Polimero, Metallo Polymer, Metal	○ Bianco White	3x max 100W E27	Si Yes	Vedi tabella p. 181 See table p. 181	1.460,00 €
F556180375NENE	Polimero, Metallo Polymer, Metal	● Nero Black	3x max 100W E27	Si Yes	Vedi tabella p. 181 See table p. 181	2.650,00 €

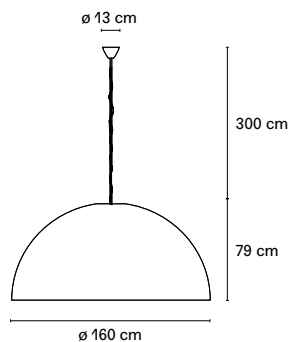

Codice Code	Materiale Material	Colore Colour	Sorgente luminosa Light source	Dimmerabile Dimmable	Classe energetica Energy label	Prezzo Retail con IVA Retail Price VAT incl.
F556185350BINE	Polimero, Metallo Polymer, Metal	○ Bianco White	3x max 150W E27	Si Yes	Vedi tabella p. 181 See table p. 181	2.150,00 €
F556185375NENE	Polimero, Metallo Polymer, Metal	● Nero Black	3x max 150W E27	Si Yes	Vedi tabella p. 181 See table p. 181	3.700,00 €

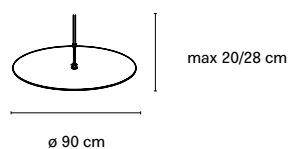

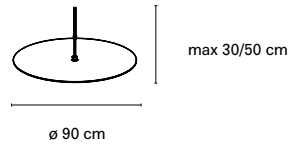

Codice Code	Materiale Material	Colore Colour	Descrizione Description	Prezzo Retail con IVA Retail Price VAT incl.
R556203K00CB00	Polimero, Metallo Polymer, Metall	◐ Cromo, Bianco Chrome, White	Disco di chiusura con tige telescopica per F556185350BINE e F556185375NENE Closing disk with telescopic stem for F556185350BINE and F556185375NENE	545,00 €



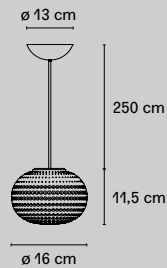

Codice Code	Materiale Material	Colore Colour	Descrizione Description	Prezzo Retail con IVA Retail Price VAT incl.
R556200K00CB00	Polimero, Metallo Polymer, Metall	 Cromo, Bianco Chrome, White	Disco di chiusura con tige telescopica per F556185350BINE e F556185375NENE Closing disk with telescopic stem for F556185350BINE and F556185375NENE	545,00 €

## BIANCA MATTI KLENELL 2015

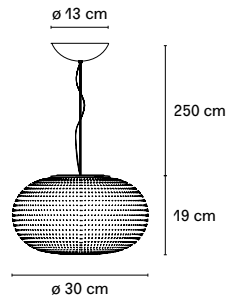

Codice Code	Materiale Material	Colore Colour	Sorgente luminosa Light source	Dimmerabile Dimmable	Classe energetica Energy label	Prezzo Retail con IVA Retail Price VAT incl.
F430680150BILE	Vetro, Metallo Glass, Metal	 Bianco White	LED 4,5W (2700K, CRI>80, 350Lm)	Si, a taglio di fase Yes, phase cut dimmer	F	370,00 €
			LED integrato Integrated LED			





Codice Code	Materiale Material	Colore Colour	Sorgente luminosa Light source	Dimmerabile Dimmable	Classe energetica Energy label	Prezzo Retail con IVA Retail Price VAT incl.
F430685150BILE	Vetro, Metallo Glass, Metal	 Bianco White	LED 17,5W (2700K, CRI>80, 1650Lm)	Si, TRIAC Yes, TRIAC	E	550,00 €
			LED integrato Integrated LED			

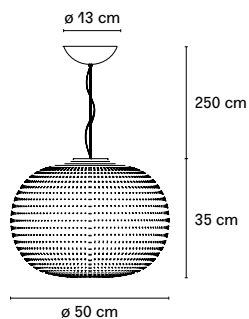





Codice Code	Materiale Material	Colore Colour	Sorgente luminosa Light source	Dimmerabile Dimmable	Classe energetica Energy label	Prezzo Retail con IVA Retail Price VAT incl.
F430690150BINE	Vetro, Metallo Glass, Metal	○ Bianco White	1x max 116W E27	Si Yes	Vedi tabella p. 181 See table p. 181	770,00 €



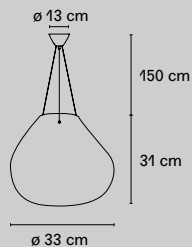

## BOLLA STUDIO HARRY-PAUL 2003

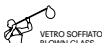

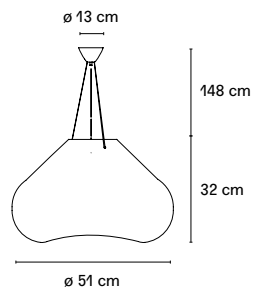

Codice Code	Materiale Material	Colore Colour	Sorgente luminosa Light source	Dimmerabile Dimmable	Classe energetica Energy label	Prezzo Retail con IVA Retail Price VAT incl.
F354085100TRNE	Vetro, Glass	○ Trasparente Transparent	1x max 77W E27	Si Yes	Vedi tabella p. 181 See table p. 181	740,00 €





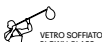

Codice Code	Materiale Material	Colore Colour	Sorgente luminosa Light source	Dimmerabile Dimmable	Classe energetica Energy label	Prezzo Retail con IVA Retail Price VAT incl.
F354090100TRNE	Vetro, Glass	○ Trasparente Transparent	1x max 77W E27	Si Yes	Vedi tabella p. 181 See table p. 181	890,00 €

**CHANDELIER**  
**DAVID CHIPPERFIELD**  
**2004**

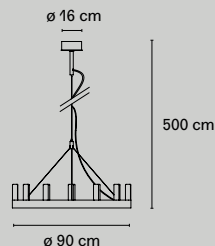

Codice Code	Materiale Material	Colore Colour	Sorgente luminosa Light source	Dimmerabile Dimmable	Classe energetica Energy label	Prezzo Retail con IVA Retail Price VAT incl.
F549180250NBNE	Metallo Verniciato, Vetro Painted Metal, Glas	● Nero, Bianco Black, White	14x max 40W E14	Si Yes	Vedi tabella p. 181 See table p. 181	3.550,00 €
F549180260OBNE	Metallo Verniciato, Vetro Painted Metal, Glas	● Oro, Bianco Glod, White	14x max 40W E14	Si Yes	Vedi tabella p. 181 See table p. 181	3.750,00 €

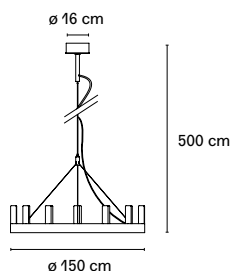

Codice Code	Materiale Material	Colore Colour	Sorgente luminosa Light source	Dimmerabile Dimmable	Classe energetica Energy label	Prezzo Retail con IVA Retail Price VAT incl.
F549185250NBNE	Metallo Verniciato, Vetro Painted Metal, Glas	● Nero, Bianco Black, White	19x max 40W E14	Si Yes	Vedi tabella p. 181 See table p. 181	4.700,00 €
F549185260OBNE	Metallo Verniciato, Vetro Painted Metal, Glas	● Oro, Bianco Glod, White	19x max 40W E14	Si Yes	Vedi tabella p. 181 See table p. 181	4.850,00 €

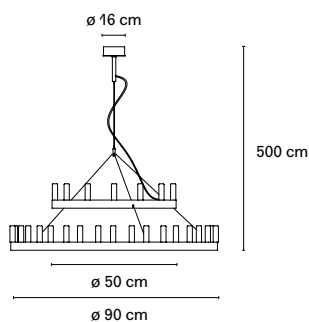

Codice Code	Materiale Material	Colore Colour	Sorgente luminosa Light source	Dimmerabile Dimmable	Classe energetica Energy label	Prezzo Retail con IVA Retail Price VAT incl.
F549190250NBNE	Metallo Verniciato, Vetro Painted Metal, Glas	● Nero, Bianco Black, White	8x max 40W E14 + 14x max 40W E14	Si Yes	Vedi tabella p. 181 See table p. 181	5.700,00 €
F549190260OBNE	Metallo Verniciato, Vetro Painted Metal, Glas	● Oro, Bianco Glod, White	8x max 40W E14 + 14x max 40W E14	Si Yes	Vedi tabella p. 181 See table p. 181	6.050,00 €



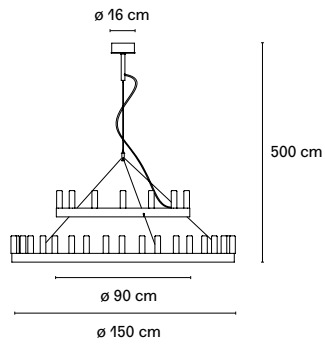

Codice Code	Materiale Material	Colore Colour	Sorgente luminosa Light source	Dimmerabile Dimmable	Classe energetica Energy label	Prezzo Retail con IVA Retail Price VAT incl.
F549195250NBNE	Metallo Verniciato, Vetro Painted Metal, Glas	● Nero, Bianco Black, White	14x max 40W E14 + 19x max 40W E14	Si Yes	Vedi tabella p. 181 See table p. 181	7.600,00 €
F549190260OBNE	Metallo Verniciato, Vetro Painted Metal, Glas	● Oro, Bianco Gold, White	14x max 40W E14 + 19x max 40W E14	Si Yes	Vedi tabella p. 181 See table p. 181	8.100,00 €



## CHESHIRE GAMFRATESI 2013

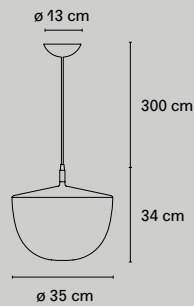





Codice Code	Materiale Material	Colore Colour	Sorgente luminosa Light source	Dimmerabile Dimmable	Classe energetica Energy label	Prezzo Retail con IVA Retail Price VAT incl.
F425785350BINE	Polimero Polymer	○ Bianco White	3x max 23W E27	Si Yes	Vedi tabella p. 181 See table p. 181	520,00 €
F425785350NENE	Polimero Polymer	● Nero Black	3x max 23W E27	Si Yes	Vedi tabella p. 181 See table p. 181	520,00 €

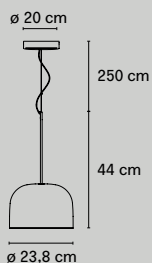

**EQUATORE**  
GABRIELE E OSCAR BURATTI  
2017



Codice Code	Materiale Material	Colore Colour	Sorgente luminosa Light source	Dimmerabile Dimmable	Classe energetica Energy label	Prezzo Retail con IVA Retail Price VAT incl.
F439080550CRLE	Vetro, Metallo Galvanizzato Glass, Galvanized Metal	 Cromo Chrome	LED 25W (2700K, CRI>90, 2900Lm)	Si, 1-10V Yes, 1-10V	F	1.380,00 €
F439080550NELE	Vetro, Metallo Galvanizzato Glass, Galvanized Metal	 Nero lucido Glossy black	LED 25W (2700K, CRI>90, 2900Lm)	Si, 1-10V Yes, 1-10V	F	1.380,00 €
F439080150OOLE	Vetro, Metallo Glass, Metal	 Oro opaco Matt gold	LED 25W (2700K, CRI>90, 2900Lm)	Si, 1-10V Yes, 1-10V	F	1.180,00 €
F439080550RSLE	Vetro, Metallo Galvanizzato Glass, Galvanized Metal	 Rame lucido Glossy copper	LED 25W (2700K, CRI>90, 2900Lm)	Si, 1-10V Yes, 1-10V	F	1.380,00 €







LED integrato  
Integrated LED

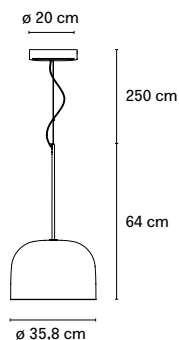

Su richiesta tecnologia  
Dali o Casambi  
Dali or Casambi  
technology on request



Codice Code	Materiale Material	Colore Colour	Sorgente luminosa Light source	Dimmerabile Dimmable	Classe energetica Energy label	Prezzo Retail con IVA Retail Price VAT incl.
F439085550CRLE	Vetro, Metallo Galvanizzato Glass, Galvanized Metal	 Cromo Chrome	LED 40W (2700K, CRI>90, 4500Lm)	Si, 1-10V Yes, 1-10V	F	1.860,00 €
F439085550NELE	Vetro, Metallo Galvanizzato Glass, Galvanized Metal	 Nero lucido Glossy black	LED 40W (2700K, CRI>90, 4500Lm)	Si, 1-10V Yes, 1-10V	F	1.860,00 €
F439085150OOLE	Vetro, Metallo Glass, Metal	 Oro opaco Matt gold	LED 40W (2700K, CRI>90, 4500Lm)	Si, 1-10V Yes, 1-10V	F	1.700,00 €
F439085550RSLE	Vetro, Metallo Galvanizzato Glass, Galvanized Metal	 Rame lucido Glossy copper	LED 40W (2700K, CRI>90, 4500Lm)	Si, 1-10V Yes, 1-10V	F	1.860,00 €







LED integrato  
Integrated LED

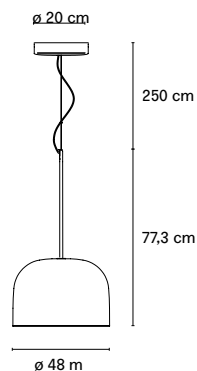

Su richiesta tecnologia  
Dali o Casambi  
Dali or Casambi  
technology on request





Codice Code	Materiale Material	Colore Colour	Sorgente luminosa Light source	Dimmerabile Dimmable	Classe energetica Energy label	Prezzo Retail con IVA Retail Price VAT incl.
F439090550CRLE	Vetro, Metallo Galvanizzato Glass, Galvanized Metal	 Cromo Chrome	LED 60W (2700K, CRI>90, 6600Lm)	Si, 1-10V Yes, 1-10V	F	3.450,00 €
F439090550NELE	Vetro, Metallo Galvanizzato Glass, Galvanized Metal	 Nero lucido Glossy black	LED 60W (2700K, CRI>90, 6600Lm)	Si, 1-10V Yes, 1-10V	F	3.450,00 €
F439090150OOLE	Vetro, Metallo Glass, Metal	 Oro opaco Matt gold	LED 60W (2700K, CRI>90, 6600Lm)	Si, 1-10V Yes, 1-10V	F	3.380,00 €
F439090550RSLE	Vetro, Metallo Galvanizzato Glass, Galvanized Metal	 Rame lucido Glossy copper	LED 60W (2700K, CRI>90, 6600Lm)	Si, 1-10V Yes, 1-10V	F	3.450,00 €







LED integrato  
Integrated LED

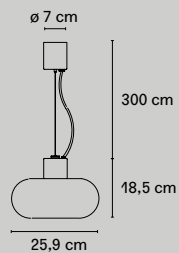

Su richiesta tecnologia  
Dali o Casambi  
Dali or Casambi  
technology on request



## FONTANELLA FEDERICO PERI 2020



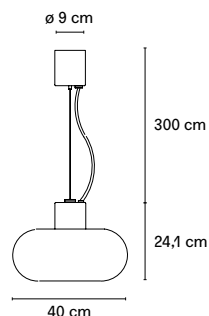

Codice Code	Materiale Material	Colore Colour	Sorgente luminosa Light source	Dimmerabile Dimmable	Classe energetica Energy label	Prezzo Retail con IVA Retail Price VAT incl.
F447890550CRNE	Vetro, Metallo Galvanizzato Glass, Galvanized Metal	 Cromo Chrome	1x max 28W E14	Si Yes	Vedi tabella p. 181 See table p. 181	650,00 €
F447890550NENE	Vetro, Metallo Galvanizzato Glass, Galvanized Metal	 Nero lucido Glossy black	1x max 28W E14	Si Yes	Vedi tabella p. 181 See table p. 181	650,00 €
F447890550OTNE	Vetro, Metallo Galvanizzato Glass, Galvanized Metal	 Ottone lucido Glossy Brass	1x max 28W E14	Si Yes	Vedi tabella p. 181 See table p. 181	670,00 €









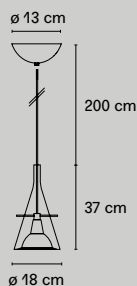

Codice Code	Materiale Material	Colore Colour	Sorgente luminosa Light source	Dimmerabile Dimmable	Classe energetica Energy label	Prezzo Retail con IVA Retail Price VAT incl.
F447885550CRNE	Vetro, Metallo Galvanizzato Glass, Galvanized Metal	 Cromo Chrome	1x max 77W E27	Si Yes	Vedi tabella p. 181 See table p. 181	870,00 €
F447885550NENE	Vetro, Metallo Galvanizzato Glass, Galvanized Metal	 Nero lucido Glossy black	1x max 77W E27	Si Yes	Vedi tabella p. 181 See table p. 181	870,00 €
F447885550OTNE	Vetro, Metallo Galvanizzato Glass, Galvanized Metal	 Ottone lucido Glossy Brass	1x max 77W E27	Si Yes	Vedi tabella p. 181 See table p. 181	890,00 €

 VETRO SOFFIATO  
BLOWN GLASS
 
 Classe #  
IP20

## FLÛTE FRANCO RAGGI 1999



Codice Code	Materiale Material	Colore Colour	Sorgente luminosa Light source	Dimmerabile Dimmable	Classe energetica Energy label	Prezzo Retail con IVA Retail Price VAT incl.
F333780150TCNE	Vetro, Metallo Glass, Metal	 Trasparente, Cromo Transparent, Chrome	1x max 70W E27	Si Yes	Vedi tabella p. 181 See table p. 181	570,00 €
F333780550NENE	Vetro, Metallo Galvanizzato Glass, Galvanized Metal	 Trasparente, Nero lucido Transparent, Glossy black	1x max 70W E27	Si Yes	Vedi tabella p. 181 See table p. 181	590,00 €
F333780550OTNE	Vetro, Metallo Galvanizzato Glass, Galvanized Metal	 Trasparente, Ottone Transparent, Brass	1x max 70W E27	Si Yes	Vedi tabella p. 181 See table p. 181	590,00 €

 VETRO SOFFIATO  
BLOWN GLASS
 
 EAC  
IP20

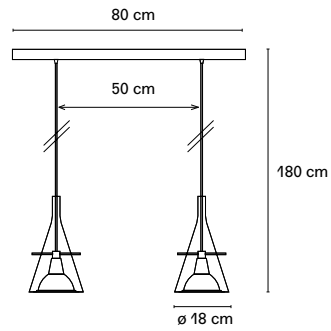

Codice Code	Materiale Material	Colore Colour	Sorgente luminosa Light source	Dimmerabile Dimmable	Classe energetica Energy label	Prezzo Retail con IVA Retail Price VAT incl.
F333785150TCNE	Vetro, Metallo Glass, Metal	 Trasparente, Cromo Transparent, Chrome	2x max 70W E27	Si Yes	Vedi tabella p. 181 See table p. 181	1.100,00 €



CE ENEC IP20

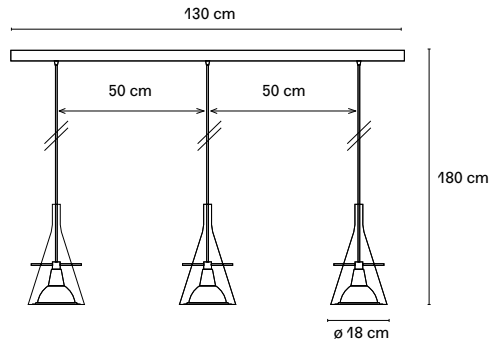

Codice Code	Materiale Material	Colore Colour	Sorgente luminosa Light source	Dimmerabile Dimmable	Classe energetica Energy label	Prezzo Retail con IVA Retail Price VAT incl.
F333790150TCNE	Vetro, Metallo Glass, Metal	 Trasparente, Cromo Transparent, Chrome	3x max 70W E27	Si Yes	Vedi tabella p. 181 See table p. 181	1.700,00 €



CE ENEC IP20

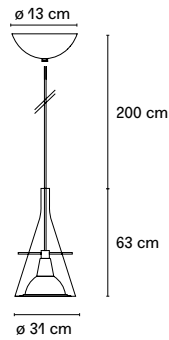



Codice Code	Materiale Material	Colore Colour	Sorgente luminosa Light source	Dimmerabile Dimmable	Classe energetica Energy label	Prezzo Retail con IVA Retail Price VAT incl.
F333795150TCNE	Vetro, Metallo Glass, Metal	 Trasparente, Cromo Transparent, Chrome	1x max 230W R7s/115	Si Yes	Vedi tabella p. 181 See table p. 181	1.550,00 €

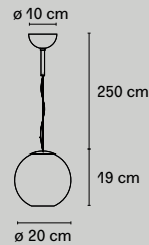

CE EAC IP20

## GLOBO DI LUCE ROBERTO MENGHI 1968





Codice Code	Materiale Material	Colore Colour	Sorgente luminosa Light source	Dimmerabile Dimmable	Classe energetica Energy label	Prezzo Retail con IVA Retail Price VAT incl.
F364480150CRNE	Vetro, Metallo Glass, Metal	 Cromo Chrome	1x max 40W E14	Si Yes	Vedi tabella p. 181 See table p. 181	540,00 €
F364480150RMNE	Vetro, Metallo Glass, Metal	 Rame Copper	1x max 40W E14	Si Yes	Vedi tabella p. 181 See table p. 181	590,00 €



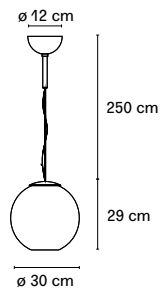

CE EAC IP20

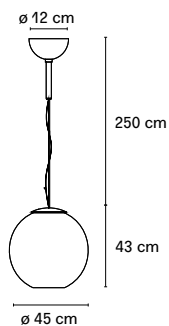

Codice Code	Materiale Material	Colore Colour	Sorgente luminosa Light source	Dimmerabile Dimmable	Classe energetica Energy label	Prezzo Retail con IVA Retail Price VAT incl.
F364485150CRNE	Vetro, Metallo Glass, Metal	 Cromo Chrome	1x max 60W G9	Si Yes	Vedi tabella p. 181 See table p. 181	720,00 €
F364485150RMNE	Vetro, Metallo Glass, Metal	 Rame Copper	1x max 60W G9	Si Yes	Vedi tabella p. 181 See table p. 181	820,00 €



Codice Code	Materiale Material	Colore Colour	Sorgente luminosa Light source	Dimmerabile Dimmable	Classe energetica Energy label	Prezzo Retail con IVA Retail Price VAT incl.
F364490150CRNE	Vetro, Metallo Glass, Metal	 Cromo Chrome	1x max 150W E27	Si Yes	Vedi tabella p. 181 See table p. 181	1.050,00 €
F364490150RMNE	Vetro, Metallo Glass, Metal	 Rame Copper	1x max 150W E27	Si Yes	Vedi tabella p. 181 See table p. 181	1.200,00 €



**HUNA**  
HISTORICAL ARCHIVE  
1965

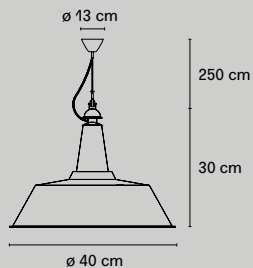

Codice Code	Materiale Material	Colore Colour	Sorgente luminosa Light source	Dimmerabile Dimmable	Classe energetica Energy label	Prezzo Retail con IVA Retail Price VAT incl.
F505985200ALNE	Metallo Verniciato Painted Metal	● Alluminio Aluminum	1x max 116W E27	Si Yes	Vedi tabella p. 181 See table p. 181	320,00 €
F505985200NENE	Metallo Verniciato Painted Metal	● Nero Black	1x max 116W E27	Si Yes	Vedi tabella p. 181 See table p. 181	320,00 €

CE ENEC IP20

**LAMPARA**  
HISTORICAL ARCHIVE  
1965

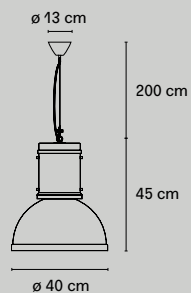

Codice Code	Materiale Material	Colore Colour	Sorgente luminosa Light source	Dimmerabile Dimmable	Classe energetica Energy label	Prezzo Retail con IVA Retail Price VAT incl.
F500090200ALNE	Metallo Verniciato Painted Metal	● Alluminio Aluminum	1x max 116W E27	Si Yes	Vedi tabella p. 181 See table p. 181	450,00 €
F500090220BINE	Metallo Verniciato Painted Metal	○ Bianca White	1x max 116W E27	Si Yes	Vedi tabella p. 181 See table p. 181	595,00 €

CE ENEC IP20

# MERIDIANO



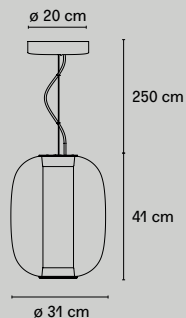

GABRIELE E OSCAR BURATTI

2020

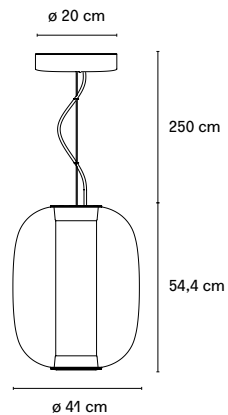

Codice Code	Materiale Material	Colore Colour	Sorgente luminosa Light source	Dimmerabile Dimmable	Classe energetica Energy label	Prezzo Retail con IVA Retail Price VAT incl.
F441785550NFLE	Vetro, Metallo Galvanizzato Glass, Galvanized Metal	 Nero, Fumè Black, Grey fumè	LED 25W* (2700K, CRI>90, 2900Lm) + LED 8W ** (2700K, 1180Lm)	*Si, 1-10V Yes, 1-10V ** No	F	1.830,00 €
F441785550NRLE	Vetro, Metallo Galvanizzato Glass, Galvanized Metal	 Nero, Rosa Black, Pink	LED 25W* (2700K, CRI>90, 2900Lm) + LED 8W ** (2700K, 1180Lm)	*Si, 1-10V Yes, 1-10V ** No	F	1.830,00 €
F441785550NTLE	Vetro, Metallo Galvanizzato Glass, Galvanized Metal	 Nero, Trasparente Black, Transparent	LED 25W* (2700K, CRI>90, 2900Lm) + LED 8W ** (2700K, 1180Lm)	*Si, 1-10V Yes, 1-10V ** No	F	1.830,00 €
			LED integrato Integrated LED	 IP20		
			Su richiesta tecnologia Dali o Casambi Dali or Casambi technology on request			



Codice Code	Materiale Material	Colore Colour	Sorgente luminosa Light source	Dimmerabile Dimmable	Classe energetica Energy label	Prezzo Retail con IVA Retail Price VAT incl.
F441790550NFLE	Vetro, Metallo Galvanizzato Glass, Galvanized Metal	 Nero, Fumè Black, Grey fumè	LED 35W* (2700K, CRI>90, 4000Lm) + LED 8W** (2700K, 1180Lm)	*Si, 1-10V Yes, 1-10V ** No	F	2.350,00 €
F441790550NRLE	Vetro, Metallo Galvanizzato Glass, Galvanized Metal	 Nero, Rosa Black, Pink	LED 35W* (2700K, CRI>90, 4000Lm) + LED 8W** (2700K, 1180Lm)	*Si, 1-10V Yes, 1-10V ** No	F	2.350,00 €
F441790550NTLE	Vetro, Metallo Galvanizzato Glass, Galvanized Metal	 Nero, Trasparente Black, Transparent	LED 35W* (2700K, CRI>90, 4000Lm) + LED 8W** (2700K, 1180Lm)	*Si, 1-10V Yes, 1-10V ** No	F	2.350,00 €
 VETRO SOFFIATO BLOWN GLASS			LED integrato Integrated LED	 IP20		
			Su richiesta tecnologia Dali o Casambi Dali or Casambi technology on request			



**OORT SISTEMA**  
**JACOPO RODA**  
**2022**

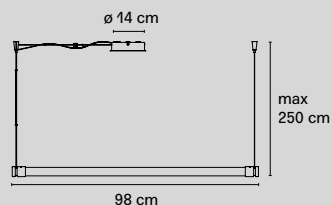

Codice Code	Materiale Material	Colore Colour	Sorgente luminosa Light source	Dimmerabile Dimmable	Classe energetica Energy label	Prezzo Retail con IVA Retail Price VAT incl.
OORT00003	Vetro, Metallo Galvanizzato Glass, Galvanized Metal	● Nichel nero Nickel black	LED 18W (3000K, 1700Lm)	Si, 1-10V/PUSH Yes, 1-10V/PUSH	G	700,00 €
OORT00012	Vetro, Metallo Galvanizzato Glass, Galvanized Metal	● Nichel nero Nickel black	LED 18W (DTW da 1800K a 4000K)	Si, 1-10V/PUSH Yes, 1-10V/PUSH	G	760,00 €

LED integrato  
Integrated LED



Su richiesta tecnologia DALI  
e 2700K  
DALI technology and 2700K  
on request

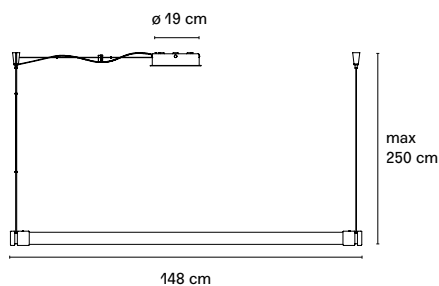

Codice Code	Materiale Material	Colore Colour	Sorgente luminosa Light source	Dimmerabile Dimmable	Classe energetica Energy label	Prezzo Retail con IVA Retail Price VAT incl.
OORT00004	Vetro, Metallo Galvanizzato Glass, Galvanized Metal	● Nichel nero Nickel black	LED 28W (3000K, 2660Lm)	Si, 1-10V/PUSH Yes, 1-10V/PUSH	G	830,00 €
OORT00013	Vetro, Metallo Galvanizzato Glass, Galvanized Metal	● Nichel nero Nickel black	LED 28W (DTW da 1800K a 4000K)	Si, 1-10V/PUSH Yes, 1-10V/PUSH	G	910,00 €

LED integrato  
Integrated LED



Su richiesta tecnologia DALI  
e 2700K  
DALI technology and 2700K  
on request

**OORT SISTEMA**  
**JACOPO RODA**  
**2022**

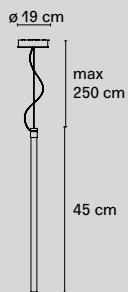

Codice Code	Materiale Material	Colore Colour	Sorgente luminosa Light source	Dimmerabile Dimmable	Classe energetica Energy label	Prezzo Retail con IVA Retail Price VAT incl.
OORT00005	Vetro, Metallo Galvanizzato Glass, Galvanized Metal	● Nichel nero Nickel black	LED 8W (3000K, 760Lm)	Si, 1-10V/PUSH Yes, 1-10V/PUSH	G	530,00 €
OORT00014	Vetro, Metallo Galvanizzato Glass, Galvanized Metal	● Nichel nero Nickel black	LED 8W (DTW da 1800K a 4000K)	Si, 1-10V/PUSH Yes, 1-10V/PUSH	G	580,00 €

LED integrato  
Integrated LED



Su richiesta tecnologia DALI  
e 2700K  
DALI technology and 2700K  
on request

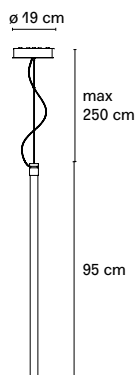

Codice Code	Materiale Material	Colore Colour	Sorgente luminosa Light source	Dimmerabile Dimmable	Classe energetica Energy label	Prezzo Retail con IVA Retail Price VAT incl.
OORT00006	Vetro, Metallo Galvanizzato Glass, Galvanized Metal	● Nichel nero Nickel black	LED 18W (3000K, 1700Lm)	Si, 1-10V/PUSH Yes, 1-10V/PUSH	G	620,00 €
OORT00015	Vetro, Metallo Galvanizzato Glass, Galvanized Metal	● Nichel nero Nickel black	LED 18W (DTW da 1800K a 4000K)	Si, 1-10V/PUSH Yes, 1-10V/PUSH	G	680,00 €

LED integrato  
Integrated LED



Su richiesta tecnologia DALI  
e 2700K  
DALI technology and 2700K  
on request

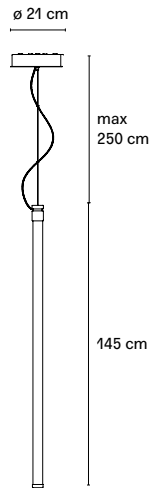

Codice Code	Materiale Material	Colore Colour	Sorgente luminosa Light source	Dimmerabile Dimmable	Classe energetica Energy label	Prezzo Retail con IVA Retail Price VAT incl.
OORT00007	Vetro, Metallo Galvanizzato Glass, Galvanized Metal	● Nichel nero Nickel black	LED 28W (3000K, 2660Lm)	Si, DALI/PUSH Yes, DALI/PUSH	G	720,00 €
OORT00016	Vetro, Metallo Galvanizzato Glass, Galvanized Metal	● Nichel nero Nickel black	LED 28W (DTW da 1800K a 4000K)	Si, DALI/PUSH Yes, DALI/PUSH	G	790,00 €
			LED integrato Integrated LED	CE IP20		
			Su richiesta 2700K 2700K on request			

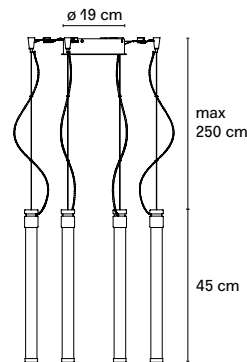

Codice Code	Materiale Material	Colore Colour	Sorgente luminosa Light source	Dimmerabile Dimmable	Classe energetica Energy label	Prezzo Retail con IVA Retail Price VAT incl.
OORT00008	Vetro, Metallo Galvanizzato Glass, Galvanized Metal	● Nichel nero Nickel black	LED 4x8W (3000K, 3040Lm)	Si, 1-10V/PUSH Yes, 1-10V/PUSH	G	1.620,00 €
OORT00017	Vetro, Metallo Galvanizzato Glass, Galvanized Metal	● Nichel nero Nickel black	LED 4x8W (DTW da 1800K a 4000K)	Si, 1-10V/PUSH Yes, 1-10V/PUSH	G	1.770,00 €
			LED integrato Integrated LED	CE IP20		
			Su richiesta tecnologia DALI e 2700K DALI technology and 2700K on request			

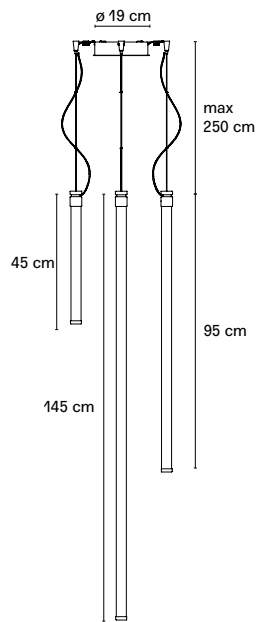

Codice Code	Materiale Material	Colore Colour	Sorgente luminosa Light source	Dimmerabile Dimmable	Classe energetica Energy label	Prezzo Retail con IVA Retail Price VAT incl.
OORT00009	Vetro, Metallo Galvanizzato Glass, Galvanized Metal	● Nichel nero Nickel black	LED 8W + 18W + 28W (3000K, 5130Lm)	Si, 1-10V/PUSH Yes, 1-10V/PUSH	G	1.540,00 €
OORT00018	Vetro, Metallo Galvanizzato Glass, Galvanized Metal	● Nichel nero Nickel black	LED 8W + 18W + 28W (DTW da 1800K a 4000K)	Si, 1-10V/PUSH Yes, 1-10V/PUSH	G	1.680,00 €

LED integrato  
Integrated LED



Su richiesta tecnologia DALI  
e 2700K  
DALI technology and 2700K  
on request



**PALLINA**  
FONTANAARTE DESIGN LAB  
2019



Codice Code	Materiale Material	Colore Colour	Sorgente luminosa Light source	Dimmerabile Dimmable	Classe energetica Energy label	Prezzo Retail con IVA Retail Price VAT incl.
F443080150NENE	Vetro, Metallo Galvanizzato Glass, Galvanized Metal	● Nero lucido Glossy black	1x max 6W G9	Si Yes	Vedi tabella p. 181 See table p. 181	375,00 €
F443080150NSNE	Vetro, Metallo Galvanizzato Glass, Galvanized Metal	● Nichel lucido Glossy nickel	1x max 6W G9	Si Yes	Vedi tabella p. 181 See table p. 181	375,00 €
F443080150OTNE	Vetro, Metallo Galvanizzato Glass, Galvanized Metal	● Ottone lucido Glossy brass	1x max 6W G9	Si Yes	Vedi tabella p. 181 See table p. 181	375,00 €
F443080150ORNE	Vetro, Metallo Verniciato Glass, Painted Metal	● Oro rosa Rose gold	1x max 6W G9	Si Yes	Vedi tabella p. 181 See table p. 181	385,00 €

 VETRO SOFFIATO  
BLOWN GLASS



Con tige di 2 differenti misure  
Shaft 2 different sizes

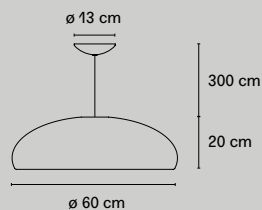

 Classe II  
IP20

**PANGEN**  
HISTORICAL ARCHIVE  
1969





Codice Code	Materiale Material	Colore Colour	Sorgente luminosa Light source	Dimmerabile Dimmable	Classe energetica Energy label	Prezzo Retail con IVA Retail Price VAT incl.
F419685350BINE	Polimero, Metallo Polymer, Metal	○ Bianco White	3x max 46W E27	Si Yes	Vedi tabella p. 181 See table p. 181	835,00 €
F419685350NENE	Polimero, Metallo Polymer, Metal	● Nero Black	3x max 46W E27	Si Yes	Vedi tabella p. 181 See table p. 181	835,00 €
F419685350RONE	Polimero, Metallo Polymer, Metal	● Rosso Red	3x max 46W E27	Si Yes	Vedi tabella p. 181 See table p. 181	835,00 €

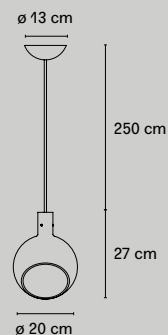

 IP20

**PAROLA**  
GAE AULENTI  
E PIERO CASTIGLIONI  
1980







Codice Code	Materiale Material	Colore Colour	Sorgente luminosa Light source	Dimmerabile Dimmable	Classe energetica Energy label	Prezzo Retail con IVA Retail Price VAT incl.
F428485100AMNE	Vetro Glass	 Ambra Amber	1x max 3,5W G9	Si Yes	Vedi tabella p. 181 See table p. 181	500,00 €
F428485100BINE	Vetro Glass	 Bianco White	1x max 3,5W G9	Si Yes	Vedi tabella p. 181 See table p. 181	500,00 €

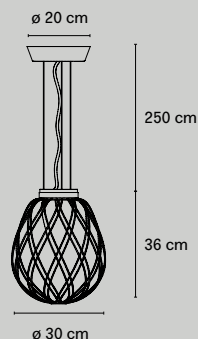

**PINECONE**  
PAOLA NAVONE  
2016



Codice Code	Materiale Material	Colore Colour	Sorgente luminosa Light source	Dimmerabile Dimmable	Classe energetica Energy label	Prezzo Retail con IVA Retail Price VAT incl.
F436385550TCNE	Vetro, Metallo Galvanizzato Glass, Galvanized Metal	 Trasparente, Cromo Transparent, Chrome	1x max 116W E27	Si Yes	Vedi tabella p. 181 See table p. 181	1.790,00 €
F436385550CBNE	Vetro, Metallo Galvanizzato Glass, Galvanized Metal	 Bianco, Cromo White, Chrome	1x max 116W E27	Si Yes	Vedi tabella p. 181 See table p. 181	1.790,00 €
F436385575TONE	Vetro, Metallo Galvanizzato Glass, Galvanized Metal	 Trasparente, Oro Transparent, Gold	1x max 116W E27	Si Yes	Vedi tabella p. 181 See table p. 181	1.890,00 €
F436385575OBNE	Vetro, Metallo Galvanizzato Glass, Galvanized Metal	 Bianco, Oro White, Gold	1x max 116W E27	Si Yes	Vedi tabella p. 181 See table p. 181	1.890,00 €



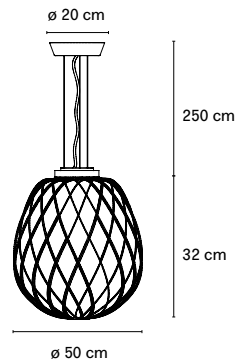

Codice Code	Materiale Material	Colore Colour	Sorgente luminosa Light source	Dimmerabile Dimmable	Classe energetica Energy label	Prezzo Retail con IVA Retail Price VAT incl.
F433990550TCNE	Vetro, Metallo Galvanizzato Glass, Galvanized Metal	Trasparente, Cromo Transparent, Chrome	1x max 116W E27	Si Yes	Vedi tabella p. 181 See table p. 181	2.230,00 €
F433990550CBNE	Vetro, Metallo Galvanizzato Glass, Galvanized Metal	Bianco, Cromo White, Chrome	1x max 116W E27	Si Yes	Vedi tabella p. 181 See table p. 181	2.230,00 €
F433990575TONE	Vetro, Metallo Galvanizzato Glass, Galvanized Metal	Trasparente, Oro Transparent, Gold	1x max 116W E27	Si Yes	Vedi tabella p. 181 See table p. 181	2.600,00 €
F433990575OBNE	Vetro, Metallo Galvanizzato Glass, Galvanized Metal	Bianco, Oro White, Gold	1x max 116W E27	Si Yes	Vedi tabella p. 181 See table p. 181	2.600,00 €

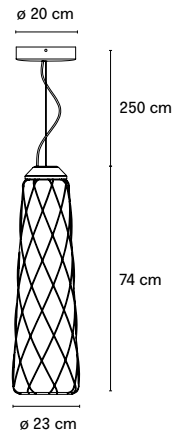

Codice Code	Materiale Material	Colore Colour	Sorgente luminosa Light source	Dimmerabile Dimmable	Classe energetica Energy label	Prezzo Retail con IVA Retail Price VAT incl.
F446690550TCLE	Vetro, Metallo Galvanizzato Glass, Galvanized Metal	Trasparente, Cromo Transparent, Chrome	LED 17W (2700K, CRI>90, 2430Lm)	Si, 1-10V / PUSH Yes, 1-10V / PUSH	E	2.800,00 €
F446690575TOLE	Vetro, Metallo Galvanizzato Glass, Galvanized Metal	Trasparente, Oro Transparent, Gold	LED 17W (2700K, CRI>90, 2430Lm)	Si, 1-10V / PUSH Yes, 1-10V / PUSH	E	2.930,00 €







LED integrato  
Integrated LED



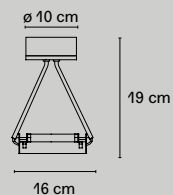



Su richiesta tecnologia DALI  
DALI technology a on  
request

**SCINTILLA**  
LIVIO E PIERO CASTIGLIONI  
1972

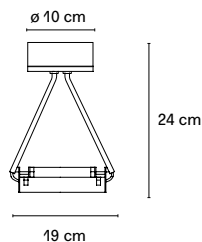

Codice Code	Materiale Material	Colore Colour	Sorgente luminosa Light source	Dimmerabile Dimmable	Classe energetica Energy label	Prezzo Retail con IVA Retail Price VAT incl.
FS15085250CRNE	Metallo, Vetro Metall, Glass	 Cromo Chrome	1x max 120W R7s/80	Si Yes	Vedi tabella p. 181 See table p. 181	310,00 €
FS15085250NSNE	Metallo, Vetro Metall, Glass	 Nichel satinato Satin nickel	1x max 120W R7s/80	Si Yes	Vedi tabella p. 181 See table p. 181	310,00 €
Compreso distanziatore Including spacer						



Codice Code	Materiale Material	Colore Colour	Sorgente luminosa Light source	Dimmerabile Dimmable	Classe energetica Energy label	Prezzo Retail con IVA Retail Price VAT incl.
FS30090250CRNE	Metallo, Vetro Metall, Glass	 Cromo Chrome	1x max 230W R7s/80	Si Yes	Vedi tabella p. 181 See table p. 181	325,00 €
FS30090250NSNE	Metallo, Vetro Metall, Glass	 Nichel satinato Satin nickel	1x max 230W R7s/80	Si Yes	Vedi tabella p. 181 See table p. 181	325,00 €
Compreso distanziatore Including spacer						

Codice Code	Materiale Material	Colore Colour	Descrizione Description	Prezzo Retail con IVA Retail Price VAT incl.
RS15000M02AL00	Metallo Metall	 Alluminio Aluminum	Riflettore per FS15085250..NE, Reflector for FS15085250..NE	40,00 €
RS30000M02AL00	Metallo Metall	 Alluminio Aluminum	Riflettore per FS30090250..NE, Reflector for FS30090250..NE	50,00 €



**SERPENTINE**  
GABI PERETTO  
2011

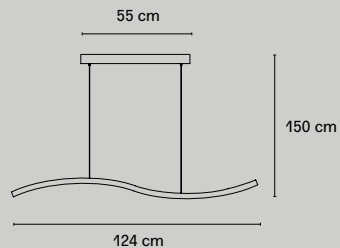

Codice Code	Materiale Material	Colore Colour	Sorgente luminosa Light source	Dimmerabile Dimmable	Classe energetica Energy label	Prezzo Retail con IVA Retail Price VAT incl.
F417585350BILE	Polimero, Metallo Polymer, Metal	○ Bianco White	LED 364x23W (3500K, CRI>80, 2090Lm)	Si, DALI Yes, DALI	F	880,00 €
			LED integrato Integrated LED	CE ENEC Intertek IP20		

**SETAREH**  
FRANCESCO LIBRIZZI  
2017

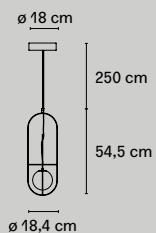

Codice Code	Materiale Material	Colore Colour	Sorgente luminosa Light source	Dimmerabile Dimmable	Classe energetica Energy label	Prezzo Retail con IVA Retail Price VAT incl.
F438080550NBLE	Vetro, Metallo Galvanizzato Glass, Galvanized Metal	● Nero lucido, Bianco Glossy black, White	LED 12W (2700K, CRI>80, 1550Lm)	Si, 1-10V / PUSH Yes, 1-10V / PUSH	E	940,00 €
F438080550OBLE	Vetro, Metallo Galvanizzato Glass, Galvanized Metal	● Oro lucido, Bianco Glossy gold, White	LED 12W (2700K, CRI>80, 1550Lm)	Si, 1-10V / PUSH Yes, 1-10V / PUSH	E	940,00 €
			LED integrato Integrated LED	CE ENEC Intertek IP20		
			Possibilità di acquisto con tecnologia Dali o Casambi su richiesta Dali or Casambi technology on request			



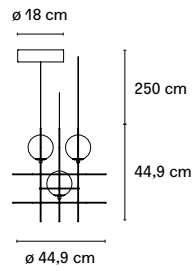

Codice Code	Materiale Material	Colore Colour	Sorgente luminosa Light source	Dimmerabile Dimmable	Classe energetica Energy label	Prezzo Retail con IVA Retail Price VAT incl.
F438380550NBLE	Vetro, Metallo Galvanizzato Glass, Galvanized Metal	Nero lucido, Bianco Glossy black, White	LED 3x6W (2700K, CRI>80, 2500Lm)	Si, 1-10V / PUSH Yes, 1-10V / PUSH	E	1.800,00 €
F438380550OBLE	Vetro, Metallo Galvanizzato Glass, Galvanized Metal	Oro lucido, Bianco Glossy gold, White	LED 3x6W (2700K, CRI>80, 2500Lm)	Si, 1-10V / PUSH Yes, 1-10V / PUSH	E	1.800,00 €



LED integrato  
Integrated LED



Su richiesta tecnologia  
Dali o Casambi  
Dali or Casambi  
technology on request

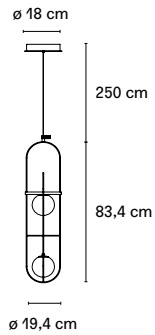

Codice Code	Materiale Material	Colore Colour	Sorgente luminosa Light source	Dimmerabile Dimmable	Classe energetica Energy label	Prezzo Retail con IVA Retail Price VAT incl.
F440485550NBLE	Vetro, Metallo Galvanizzato Glass, Galvanized Metal	Nero lucido, Bianco Glossy black, White	LED 2x6W (2700K, CRI>80, 1660Lm)	Si, 1-10V / PUSH Yes, 1-10V / PUSH	E	1.300,00 €
F440485550OBLE	Vetro, Metallo Galvanizzato Glass, Galvanized Metal	Oro lucido, Bianco Glossy gold, White	LED 2x6W (2700K, CRI>80, 1660Lm)	Si, 1-10V / PUSH Yes, 1-10V / PUSH	E	1.300,00 €



LED integrato  
Integrated LED



Su richiesta tecnologia  
Dali o Casambi  
Dali or Casambi  
technology on request

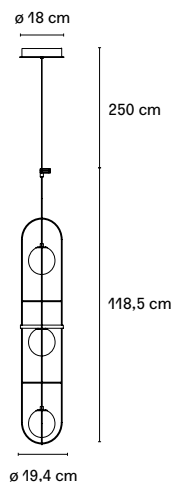

Codice Code	Materiale Material	Colore Colour	Sorgente luminosa Light source	Dimmerabile Dimmable	Classe energetica Energy label	Prezzo Retail con IVA Retail Price VAT incl.
F440590550NBLE	Vetro, Metallo Galvanizzato Glass, Galvanized Metal	Nero lucido, Bianco Glossy black, White	LED 3x6W (2700K, CRI>80, 2500Lm)	Si, 1-10V / PUSH Yes, 1-10V / PUSH	E	1.750,00 €
F440590550OBLE	Vetro, Metallo Galvanizzato Glass, Galvanized Metal	Oro lucido, Bianco Glossy gold, White	LED 3x6W (2700K, CRI>80, 2500Lm)	Si, 1-10V / PUSH Yes, 1-10V / PUSH	E	1.750,00 €
VETRO SOFFIATO BLOWN GLASS			LED integrato Integrated LED		IP20	
			Su richiesta tecnologia Dali o Casambi Dali or Casambi technology on request			

## SETAREH FRANCESCO LIBRIZZI 2017

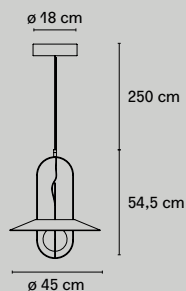

Codice Code	Materiale Material	Colore Colour	Sorgente luminosa Light source	Dimmerabile Dimmable	Classe energetica Energy label	Prezzo Retail con IVA Retail Price VAT incl.
F438G80550NBLE	Vetro, Metallo Galvanizzato Glass, Galvanized Metal	Nero lucido, Bianco Glossy black, White	LED 12W (2700K, CRI>80, 1550Lm)	Si, 1-10V / PUSH Yes, 1-10V / PUSH	E	1.100,00 €
F438G80550OBLE	Vetro, Metallo Galvanizzato Glass, Galvanized Metal	Oro lucido, Bianco Glossy gold, White	LED 12W (2700K, CRI>80, 1550Lm)	Si, 1-10V / PUSH Yes, 1-10V / PUSH	E	1.100,00 €
VETRO SOFFIATO BLOWN GLASS			LED integrato Integrated LED		IP20	
Con diffusore in vetro With glass diffuser			Su richiesta tecnologia Dali o Casambi Dali or Casambi technology on request			

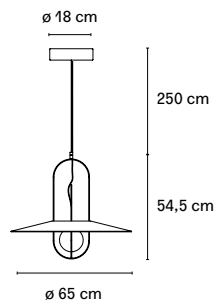

Codice Code	Materiale Material	Colore Colour	Sorgente luminosa Light source	Dimmerabile Dimmable	Classe energetica Energy label	Prezzo Retail con IVA Retail Price VAT incl.
F438G85550NBLE	Vetro, Metallo Galvanizzato Glass, Galvanized Metal	● Nero lucido, Bianco Glossy black, White	LED 12W (2700K, CRI>80, 1550Lm)	Si, 1-10V / PUSH Yes, 1-10V / PUSH	E	1.200,00 €
F438G85550OBLE	Vetro, Metallo Galvanizzato Glass, Galvanized Metal	● Oro lucido, Bianco Glossy gold, White	LED 12W (2700K, CRI>80, 1550Lm)	Si, 1-10V / PUSH Yes, 1-10V / PUSH	E	1.200,00 €



Con diffusore in vetro  
With glass diffuser

LED integrato  
Integrated LED



Su richiesta tecnologia  
Dali o Casambi  
Dali or Casambi  
technology on request

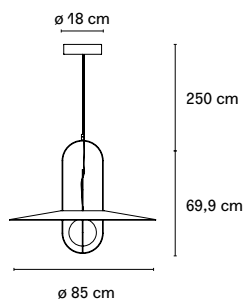

Codice Code	Materiale Material	Colore Colour	Sorgente luminosa Light source	Dimmerabile Dimmable	Classe energetica Energy label	Prezzo Retail con IVA Retail Price VAT incl.
F438G90550NBLE	Vetro, Metallo Galvanizzato Glass, Galvanized Metal	● Nero lucido, Bianco Glossy black, White	LED 17W (2700K, CRI>80, 2100Lm)	Si, 1-10V / PUSH Yes, 1-10V / PUSH	E	1.450,00 €
F438G90550OBLE	Vetro, Metallo Galvanizzato Glass, Galvanized Metal	● Oro lucido, Bianco Glossy gold, White	LED 17W (2700K, CRI>80, 2100Lm)	Si, 1-10V / PUSH Yes, 1-10V / PUSH	E	1.450,00 €



Con diffusore in vetro  
With glass diffuser

LED integrato  
Integrated LED



Su richiesta tecnologia  
Dali o Casambi  
Dali or Casambi  
technology on request

**SETAREH**  
FRANCESCO LIBRIZZI  
2017

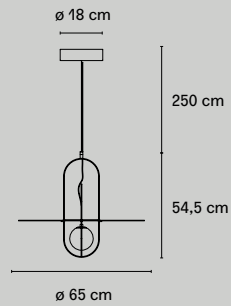

Codice Code	Materiale Material	Colore Colour	Sorgente luminosa Light source	Dimmerabile Dimmable	Classe energetica Energy label	Prezzo Retail con IVA Retail Price VAT incl.
F438M85550NBLE	Vetro, Metallo Galvanizzato Glass, Galvanized Metal	● Nero lucido, Bianco Glossy black, White	LED 12W (2700K, CRI>80, 1550Lm)	Si, 1-10V / PUSH Yes, 1-10V / PUSH	E	1.450,00 €
F438M85550OBLE	Vetro, Metallo Galvanizzato Glass, Galvanized Metal	● Oro lucido, Bianco Glossy gold, White	LED 12W (2700K, CRI>80, 1550Lm)	Si, 1-10V / PUSH Yes, 1-10V / PUSH	E	1.450,00 €



Con diffusore in metallo  
With metal diffuser

LED integrato  
Integrated LED



Su richiesta tecnologia  
Dali o Casambi  
Dali or Casambi  
technology on request

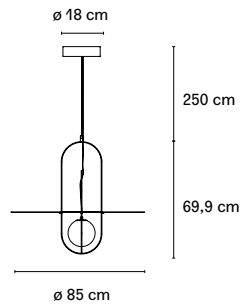

Codice Code	Materiale Material	Colore Colour	Sorgente luminosa Light source	Dimmerabile Dimmable	Classe energetica Energy label	Prezzo Retail con IVA Retail Price VAT incl.
F438M90550NBLE	Vetro, Metallo Galvanizzato Glass, Galvanized Metal	● Nero lucido, Bianco Glossy black, White	LED 17W (2700K, CRI>80, 2100Lm)	Si, 1-10V / PUSH Yes, 1-10V / PUSH	E	1.600,00 €
F438M90550OBLE	Vetro, Metallo Galvanizzato Glass, Galvanized Metal	● Oro lucido, Bianco Glossy gold, White	LED 17W (2700K, CRI>80, 2100Lm)	Si, 1-10V / PUSH Yes, 1-10V / PUSH	E	1.600,00 €



Con diffusore in metallo  
With metal diffuser



LED integrato  
Integrated LED

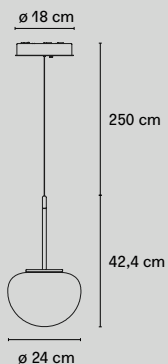

Su richiesta tecnologia  
Dali o Casambi  
Dali or Casambi  
technology on request

**THEA**  
GABRIELE E OSCAR BURATTI  
2022





Codice Code	Materiale Material	Colore Colour	Sorgente luminosa Light source	Dimmerabile Dimmable	Classe energetica Energy label	Prezzo Retail con IVA Retail Price VAT incl.
F444985550NFLE	Vetro, Metallo Galvanizzato Glass, Galvanized Metal	 Nero lucido, Fumè Glossy black, Grey fumè	LED 3,85W (3000K, CRI>90, 640Lm)	Si, TRIAC Yes, TRIAC	F	1.090,00 €
F444985575RTLE	Vetro, Metallo Galvanizzato Glass, Galvanized Metal	 Rame lucido, Trasparente Glossy copper, Transparent	LED 3,85W (3000K, CRI>90, 640Lm)	Si, TRIAC Yes, TRIAC	F	1.090,00 €

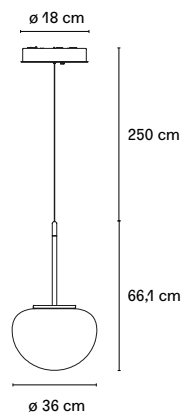

LED integrato  
Integrated LED

CE IP40



Codice Code	Materiale Material	Colore Colour	Sorgente luminosa Light source	Dimmerabile Dimmable	Classe energetica Energy label	Prezzo Retail con IVA Retail Price VAT incl.
F444990550NFLE	Vetro, Metallo Galvanizzato Glass, Galvanized Metal	 Nero lucido, Fumè Glossy black, Grey fumè	LED 11,6W (3000K, CRI>90, 1596Lm)	Si, 1-10V/PUSH Yes, 1-10V/PUSH	F	1.500,00 €
F444990575RTLE	Vetro, Metallo Galvanizzato Glass, Galvanized Metal	 Rame lucido, Trasparente Glossy copper, Transparent	LED 11,6W (3000K, CRI>90, 1596Lm)	Si, 1-10V/PUSH Yes, 1-10V/PUSH	F	1.500,00 €





LED integrato  
Integrated LED

CE IP40

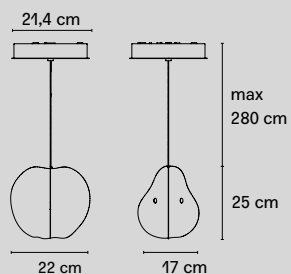

**TUTTI**  
**MELA/PERA - APPLE/PEAR**  
**MATILDE CASSANI**  
**2022**



Codice Code	Materiale Material	Colore Colour	Sorgente luminosa Light source	Dimmerabile Dimmable	Classe energetica Energy label	Prezzo Retail con IVA Retail Price VAT incl.
F446880240CRLE	Metallo Metal	 Cromo Chrome	12W LED (3000K, CRI>90, 1470Lm)	Si, TRIAC Yes, TRIAC	F	570,00 €
F446880240OOLE	Metallo Metal	 Oro Gold	12W LED (3000K, CRI>90, 1470Lm)	Si, TRIAC Yes, TRIAC	F	600,00 €
			LED integrato Integrated LED	 IP20		

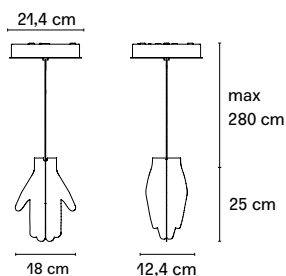

**MANO APERTA/MANO CHIUSA -**  
**HAND OPEN/HAND CLOSE**



Codice Code	Materiale Material	Colore Colour	Sorgente luminosa Light source	Dimmerabile Dimmable	Classe energetica Energy label	Prezzo Retail con IVA Retail Price VAT incl.
F446980240CRLE	Metallo Metal	 Cromo Chrome	12W LED (3000K, CRI>90, 1470Lm)	Si, TRIAC Yes, TRIAC	F	560,00 €
F446980240OOLE	Metallo Metal	 Oro Gold	12W LED (3000K, CRI>90, 1470Lm)	Si, TRIAC Yes, TRIAC	F	590,00 €
			LED integrato Integrated LED	 IP20		

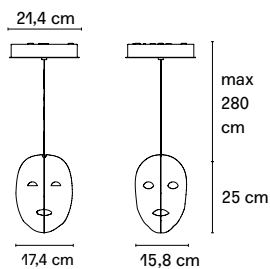

UOMO/DONNA -  
MAN/WOMAN

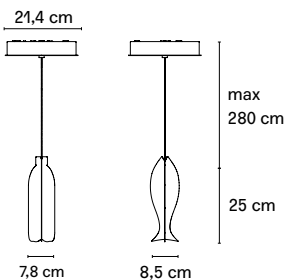

Codice Code	Materiale Material	Colore Colour	Sorgente luminosa Light source	Dimmerabile Dimmable	Classe energetica Energy label	Prezzo Retail con IVA Retail Price VAT incl.
F447080240CRLE	Metallo Metal	 Cromo Chrome	12W LED (3000K, CRI>90, 1470Lm)	Si, TRIAC Yes, TRIAC	F	610,00 €
F447080240OOLE	Metallo Metal	 Oro Gold	12W LED (3000K, CRI>90, 1470Lm)	Si, TRIAC Yes, TRIAC	F	640,00 €
LED integrato Integrated LED						

BOTTIGLIA/PESCE -  
BOTTLE/FISH





Codice Code	Materiale Material	Colore Colour	Sorgente luminosa Light source	Dimmerabile Dimmable	Classe energetica Energy label	Prezzo Retail con IVA Retail Price VAT incl.
F447180240CRLE	Metallo Metal	 Cromo Chrome	12W LED (3000K, CRI>90, 1470Lm)	Si, TRIAC Yes, TRIAC	F	440,00 €
F447180240OOLE	Metallo Metal	 Oro Gold	12W LED (3000K, CRI>90, 1470Lm)	Si, TRIAC Yes, TRIAC	F	460,00 €
LED integrato Integrated LED						



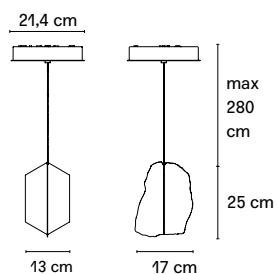



## SASSO/DIAMANTE - STONE/DIAMOND

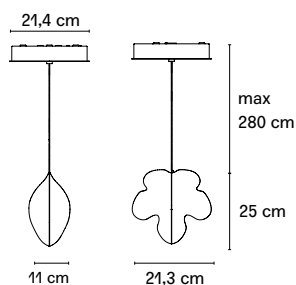

Codice Code	Materiale Material	Colore Colour	Sorgente luminosa Light source	Dimmerabile Dimmable	Classe energetica Energy label	Prezzo Retail con IVA Retail Price VAT incl.
F447380240CRLE	Metallo Metal	 Cromo Chrome	12W LED (3000K, CRI>90, 1470Lm)	Si, TRIAC Yes, TRIAC	F	530,00 €
F447380240OOLE	Metallo Metal	 Oro Gold	12W LED (3000K, CRI>90, 1470Lm)	Si, TRIAC Yes, TRIAC	F	560,00 €
LED integrato Integrated LED				 IP20		



## FOGLIE - LEAVES



Codice Code	Materiale Material	Colore Colour	Sorgente luminosa Light source	Dimmerabile Dimmable	Classe energetica Energy label	Prezzo Retail con IVA Retail Price VAT incl.
F447280240CRLE	Metallo Metal	 Cromo Chrome	12W LED (3000K, CRI>90, 1470Lm)	Si, TRIAC Yes, TRIAC	F	500,00 €
F447280240OOLE	Metallo Metal	 Oro Gold	12W LED (3000K, CRI>90, 1470Lm)	Si, TRIAC Yes, TRIAC	F	530,00 €
LED integrato Integrated LED				 IP20		

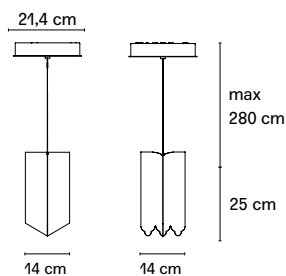

DRAPPO/SCUDETTO -  
DRAPE/BADGE



Codice Code	Materiale Material	Colore Colour	Sorgente luminosa Light source	Dimmerabile Dimmable	Classe energetica Energy label	Prezzo Retail con IVA Retail Price VAT incl.
F447480240CRLE	Metallo Metal	 Cromo Chrome	12W LED (3000K, CRI>90, 1470Lm)	Si, TRIAC Yes, TRIAC	F	590,00 €
F447480240OOLE	Metallo Metal	 Oro Gold	12W LED (3000K, CRI>90, 1470Lm)	Si, TRIAC Yes, TRIAC	F	620,00 €
LED integrato Integrated LED				 IP20		

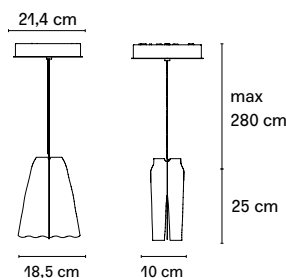

GONNA / PANTALONI -  
SKIRT / TROUSERS



Codice Code	Materiale Material	Colore Colour	Sorgente luminosa Light source	Dimmerabile Dimmable	Classe energetica Energy label	Prezzo Retail con IVA Retail Price VAT incl.
F447580240CRLE	Metallo Metal	 Cromo Chrome	12W LED (3000K, CRI>90, 1470Lm)	Si, TRIAC Yes, TRIAC	F	520,00 €
F447580240OOLE	Metallo Metal	 Oro Gold	12W LED (3000K, CRI>90, 1470Lm)	Si, TRIAC Yes, TRIAC	F	550,00 €
LED integrato Integrated LED				 IP20		

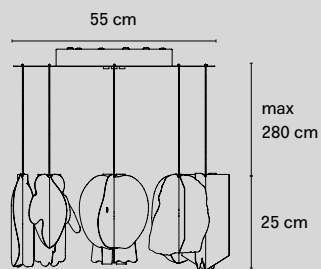

**TUTTI**  
MATILDE CASSANI  
2022

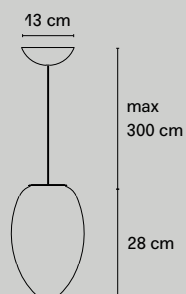

Codice Code	Materiale Material	Colore Colour	Sorgente luminosa Light source	Dimmerabile Dimmable	Classe energetica Energy label	Prezzo Retail con IVA Retail Price VAT incl.
F446890240CRLE	Metallo Metal	 Cromo Chrome	3x12W LED (3000K, CRI>90, 4410Lm)	Si, TRIAC Yes, TRIAC	F	3.000,00 €
F446890240OOLE	Metallo Metal	 Oro Gold	3x12W LED (3000K, CRI>90, 4410Lm)	Si, TRIAC Yes, TRIAC	F	3.300,00 €
LED integrato Integrated LED				 IP20		

**UOVO**  
BEN SWILDENS  
1972



Codice Code	Materiale Material	Colore Colour	Sorgente luminosa Light source	Dimmerabile Dimmable	Classe energetica Energy label	Prezzo Retail con IVA Retail Price VAT incl.
F264680100BINE	Vetro Glass	 Bianco White	1x max 30W E27	Si Yes	Vedi tabella p. 181 See table p. 181	300,00 €
				 IP20		



# OUTDOOR

NASKA XL p. 133

---

OORT SISTEMA p. 133

---

UOVO RIC. / REC. p. 136

---

UOVO p. 136

---



**NASKA XL**  
HISTORICAL ARCHIVE  
1933

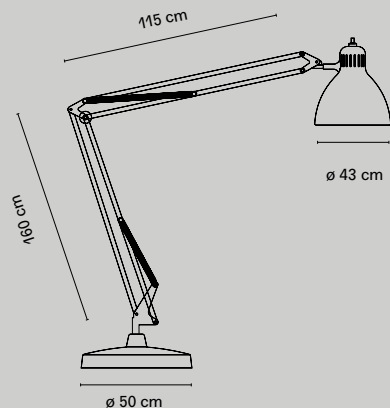

Codice Code	Materiale Material	Colore Colour	Sorgente luminosa Light source	Dimmerabile Dimmable	Classe energetica Energy label	Prezzo Retail con IVA Retail Price VAT incl.
F810528200BINE	Metallo Verniciato Painted Metal	○ Bianco White	1x max 42W E27	No	Vedi tabella p. 181 See table p. 181	3.600,00 €
F810528200NENE	Metallo Verniciato Painted Metal	● Nero Black	1x max 42W E27	No	Vedi tabella p. 181 See table p. 181	3.600,00 €

CE IP54

**OORT SISTEMA**  
JACOPO RODA  
2023

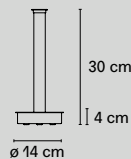

Codice Code	Materiale Material	Colore Colour	Sorgente luminosa Light source	Dimmerabile Dimmable	Classe energetica Energy label	Prezzo Retail con IVA Retail Price VAT incl.
OORT05001	Vetro, Metallo Glass, Metal	● Nero micaceo Micaceous black	LED 6W (3000K, 570Lm)	Si, Yes	G	415,00 €
OORT05011	Vetro, Metallo Glass, Metal	● Nero micaceo Micaceous black	LED 6W (DTW da 1800K a 4000K)	Si, Yes	G	445,00 €

LED integrato  
Integrated LED

CE Classe III  
IP65

Su richiesta a 2700K.  
Alimentatore non incluso.  
2700K on request. Power  
supply not included.

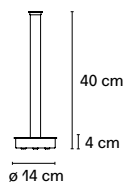

Codice Code	Materiale Material	Colore Colour	Sorgente luminosa Light source	Dimmerabile Dimmable	Classe energetica Energy label	Prezzo Retail con IVA Retail Price VAT incl.
OORT05003	Vetro, Metallo Glass, Metal	● Nero micaceo Micaceous black	LED 8W (3000K, 760Lm)	Si, Yes	G	440,00 €
OORT05013	Vetro, Metallo Glass, Metal	● Nero micaceo Micaceous black	LED 8W (DTW da 1800K a 4000K)	Si, Yes	G	470,00 €

LED integrato  
Integrated LED



Su richiesta a 2700K.  
Alimentatore non incluso.  
2700K on request. Power  
supply not included.

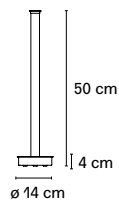

Codice Code	Materiale Material	Colore Colour	Sorgente luminosa Light source	Dimmerabile Dimmable	Classe energetica Energy label	Prezzo Retail con IVA Retail Price VAT incl.
OORT05005	Vetro, Metallo Glass, Metal	● Nero micaceo Micaceous black	LED 10W (3000K, 950Lm)	Si, Yes	G	460,00 €
OORT05015	Vetro, Metallo Glass, Metal	● Nero micaceo Micaceous black	LED 10W (DTW da 1800K a 4000K)	Si, Yes	G	490,00 €

LED integrato  
Integrated LED



Su richiesta a 2700K.  
Alimentatore non incluso.  
2700K on request. Power  
supply not included.

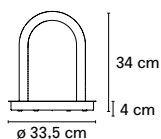

Codice Code	Materiale Material	Colore Colour	Sorgente luminosa Light source	Dimmerabile Dimmable	Classe energetica Energy label	Prezzo Retail con IVA Retail Price VAT incl.
OORT05031	Vetro, Metallo Glass, Metal	● Nero micaceo Micaceous black	LED 16W (3000K, 1520Lm)	Si, Yes	G	625,00 €
OORT05041	Vetro, Metallo Glass, Metal	● Nero micaceo Micaceous black	LED 16W (DTW da 1800K a 4000K)	Si, Yes	G	660,00 €

LED integrato  
Integrated LED



Su richiesta a 2700K.  
Alimentatore non incluso.  
2700K on request. Power  
supply not included.

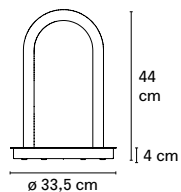

Codice Code	Materiale Material	Colore Colour	Sorgente luminosa Light source	Dimmerabile Dimmable	Classe energetica Energy label	Prezzo Retail con IVA Retail Price VAT incl.
OORT05033	Vetro, Metallo Glass, Metal	● Nero micaceo Micaceous black	LED 20W (3000K, 1900Lm)	Si, Yes	G	650,00 €
OORT05043	Vetro, Metallo Glass, Metal	● Nero micaceo Micaceous black	LED 20W (DTW da 1800K a 4000K)	Si, Yes	G	690,00 €

LED integrato  
Integrated LED



Su richiesta a 2700K.  
Alimentatore non incluso.  
2700K on request. Power  
supply not included.

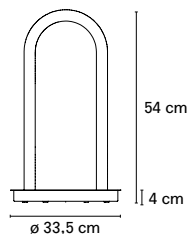

Codice Code	Materiale Material	Colore Colour	Sorgente luminosa Light source	Dimmerabile Dimmable	Classe energetica Energy label	Prezzo Retail con IVA Retail Price VAT incl.
OORT05035	Vetro, Metallo Glass, Metal	● Nero micaceo Micaceous black	LED 24W (3000K, 2280Lm)	Si, Yes	G	690,00 €
OORT05045	Vetro, Metallo Glass, Metal	● Nero micaceo Micaceous black	LED 24W (DTW da 1800K a 4000K)	Si, Yes	G	730,00 €

LED integrato  
Integrated LED



Su richiesta a 2700K.  
Alimentatore non incluso.  
2700K on request. Power  
supply not included.

## ALIMENTATORE / POWER SUPPLY

Codice Code	Descrizione Description	Dimmerabile Dimmable	Prezzo Retail con IVA Retail Price VAT incl.
RAL24020WL67ND	24V 20W / 100-240V - IP67	No	53,00 €
RAL24017EU65DT	24V 17W / 230-240V - IP65	Si, TRIAC Yes, TRIAC	53,00 €
RAL24060WL67VW	24V 60W / 110-230V - IP67	Si, 1-10V/PWM Yes, 1-10V/ PWM	105,00 €
RAL24060WL67DA	24V 60W / 110-230V - IP67	Si, DALI Yes, DALI	105,00 €



## ACCESSORI / ACCESSORY

Codice Code	Descrizione Description	Prezzo Retail con IVA Retail Price VAT incl.
OORTPIC	Picchetto Spike	32,00 €

### UOVO RICARICABILE / RECHARGEABLE BEN SWILDENS 1972

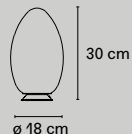

Codice Code	Materiale Material	Colore Colour	Sorgente luminosa Light source	Dimmer incluso Dimmer included	Classe energetica Energy label	Prezzo Retail con IVA Retail Price VAT incl.
F264600150BIBW	Vetro, Metallo Glass, Metal	○ Bianco White	LED 2,2W (250Lm)	Si Yes	F	395,00 €
			LED integrato Integrated LED	CE IP54		
			durata 8 ore alla massima potenza 8 hours duration at maximum power			



### UOVO BEN SWILDENS 1972

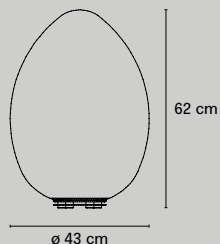

Codice Code	Materiale Material	Colore Colour	Sorgente luminosa Light source	Dimmer incluso Dimmer included	Classe energetica Energy label	Prezzo Retail con IVA Retail Price VAT incl.
F264613370BINE	Polimero, Metallo Polymer, Metal	○ Bianco White	1x max 30W E27	No	Vedi tabella p. 181 See table p. 181	825,00 €



# ARREDO E VASI / FURNITURE AND VASES

FONTANA p. 139

---

TAVOLINO 1932 p. 140

---

TAVOLO CON RUOTE p. 140

---

TOUR p. 142

---

TESO p. 143

---

CARTOCCIO p. 144

---

CARTOCCIO Q p. 144

---



**FONTANA**  
**PIETRO CHIESA**  
**1932**

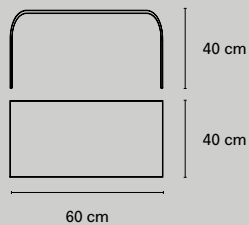

Codice Code	Materiale Material	Colore Colour	Prezzo Retail con IVA Retail Price VAT incl.
F2600TB100TR00	Vetro Glass	Trasparente Transparent	1.300,00 €

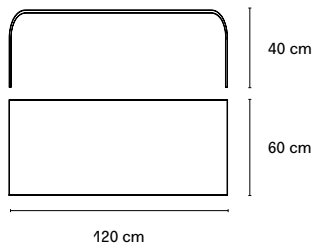

Codice Code	Materiale Material	Colore Colour	Prezzo Retail con IVA Retail Price VAT incl.
F2610TB100TR10	Vetro Glass	Trasparente Transparent	1.850,00 €

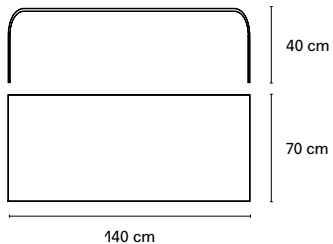

Codice Code	Materiale Material	Colore Colour	Prezzo Retail con IVA Retail Price VAT incl.
F2620TB100TR20	Vetro Glass	Trasparente Transparent	2.250,00 €

**TAVOLINO 1932**  
GIO PONTI  
1932

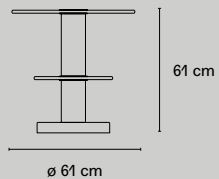

Codice Code	Materiale Material	Colore Colour	Prezzo Retail con IVA Retail Price VAT incl.
F2710TB150TR10	Vetro, Metallo Glass, Metal	Trasparente, Nichel Transparent, Nickel	2.400,00 €

**TAVOLO CON RUOTE**  
GAE AULENTI  
1980

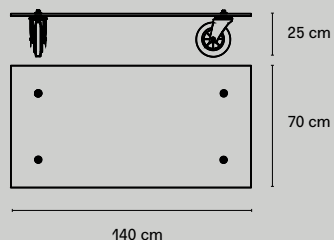

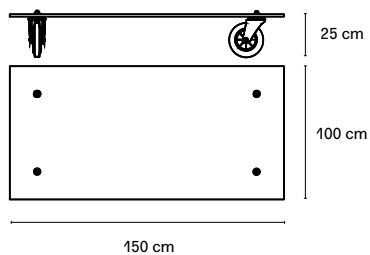

Codice Code	Materiale Material	Colore Colour	Prezzo Retail con IVA Retail Price VAT incl.
F1000TB150TR00	Vetro, Metallo Glass, Metal	Trasparente, Nero Transparent, Black	1.380,00 €

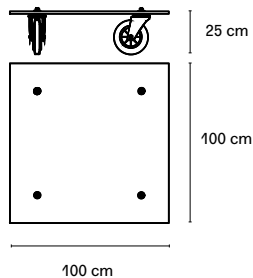

Codice Code	Materiale Material	Colore Colour	Prezzo Retail con IVA Retail Price VAT incl.
F1010TB150TR10	Vetro, Metallo Glass, Metal	Trasparente, Nero Transparent, Black	1.590,00 €



Codice Code	Materiale Material	Colore Colour	Prezzo Retail con IVA Retail Price VAT incl.
F1110TB150TR00	Vetro, Metallo Glass, Metal	 Trasparente, Nero Transparent, Black	1.380,00 € 

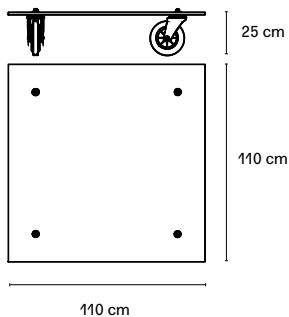

Codice Code	Materiale Material	Colore Colour	Prezzo Retail con IVA Retail Price VAT incl.
F1120TB150TR20	Vetro, Metallo Glass, Metal	 Trasparente, Nero Transparent, Black	1.560,00 €

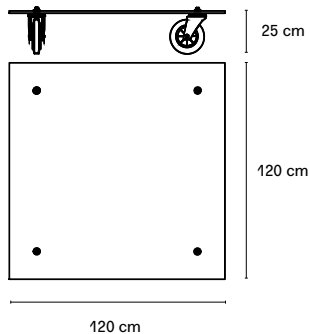

Codice Code	Materiale Material	Colore Colour	Prezzo Retail con IVA Retail Price VAT incl.
F1130TB150TR30	Vetro, Metallo Glass, Metal	 Trasparente, Nero Transparent, Black	1.590,00 €

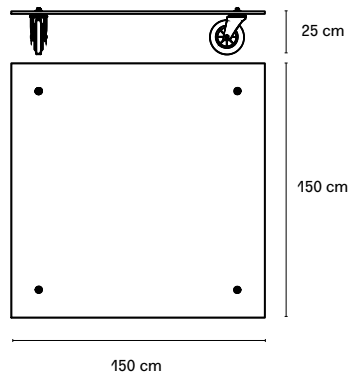

Codice Code	Materiale Material	Colore Colour	Prezzo Retail con IVA Retail Price VAT incl.
F1140TB150TR40	Vetro, Metallo Glass, Metal	 Trasparente, Nero Transparent, Black	2.050,00 €

**TOUR**  
GAE AULENTI  
1993

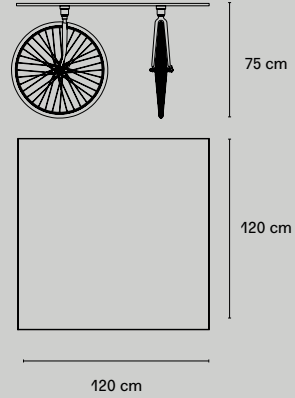

Codice Code	Materiale Material	Colore Colour	Prezzo Retail con IVA Retail Price VAT incl.
F3010TA150TR10	Vetro, Metallo Glass, Metal	 Trasparente, Cromo Transparent, Chrome	5.950,00 €

**TESO**  
**RENZO PIANO**  
**1985**

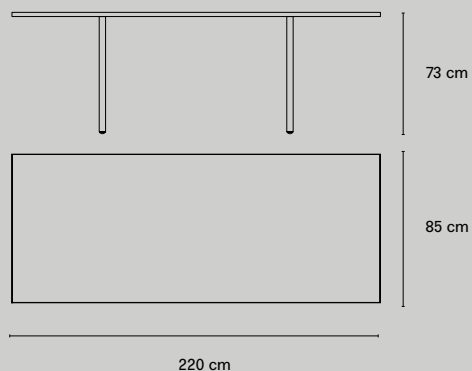

Codice Code	Materiale Material	Colore Colour	Prezzo Retail con IVA Retail Price VAT incl.
F2720TA150TR20	Vetro, Metallo Glass, Metal	 Trasparente Transparent	5.550,00 €

**TESO**  
**RENZO PIANO**  
**1991**

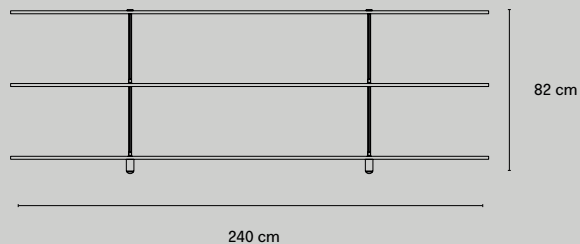

Codice Code	Materiale Material	Colore Colour	Prezzo Retail con IVA Retail Price VAT incl.
F2720CO150TR20	Vetro, Metallo Glass, Metal	 Trasparente Transparent	4.950,00 €



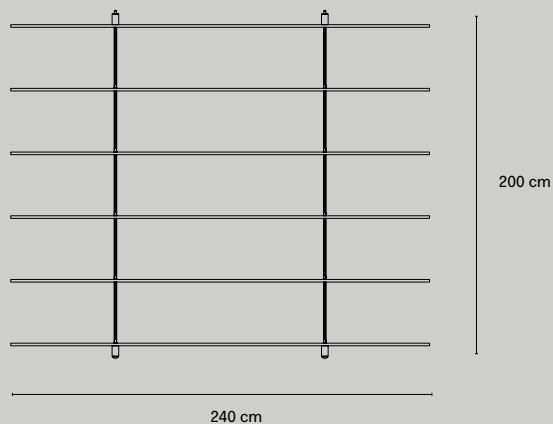

**TESO**  
RENZO PIANO  
1989



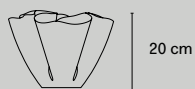

Codice Code	Materiale Material	Colore Colour	Prezzo Retail con IVA Retail Price VAT incl.
F2720LI150TR20	Vetro, Metallo Glass, Metal	 Trasparente Transparent	9.550,00 €

**CARTOCCIO**  
PIETRO CHIESA  
1932

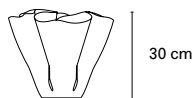

Codice Code	Materiale Material	Colore Colour	Prezzo Retail con IVA Retail Price VAT incl.
F2910VA100OP10	Vetro Glass	 Naturale Sabbciato Natural Sandblasted	680,00 €



Codice Code	Materiale Material	Colore Colour	Prezzo Retail con IVA Retail Price VAT incl.
F2920VA100TR20	Vetro Glass	 Naturale Sabbciato Natural Sandblasted	760,00 €

**CARTOCCIO Q**  
PIETRO CHIESA  
1932



Codice Code	Materiale Material	Colore Colour	Prezzo Retail con IVA Retail Price VAT incl.
F3010VA100TR10	Vetro Glass	 Trasparente Transparent	550,00 €





# INFORMAZIONI TECNICHE / TECHNICAL NOTES







RICAMBI / SPARE PARTS	p. 147
MISURE E PESI DELL'IMBALLO / PACKAGING MEASUREMENTS AND WEIGHT	p. 165
TABELLA SORGENTI LUMINOSE / TABLE FOR LIGHTING SOURCE	p. 181
LEGENDA / LEGEND	p. 187
CONDIZIONI DI VENDITA / SALES CONDITION	p. 189







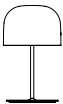

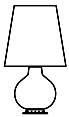

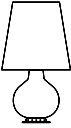

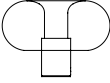

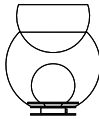
# RICAMBI / SPARE PARTS



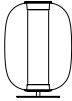

## LAMPADE DA TAVOLO TABLE LAMPS

Famiglia Family		Codice prodotto finito Product code	Codice ricambio Spare part code	Descrizione Description	Prezzo Retail con IVA Retail Price VAT incl.
<b>3247TA</b>		F324700150KBNE	R185300V01BI00	Diffusore Superiore Top Diffuser	230,00 €
			R324703M00NS00	Montatura Mounting	420,00 €
		F324710150KBNE	R185301V01BI00	Diffusore Superiore Top Diffuser	525,00 €
			R324702M00NS00	Montatura Mounting	580,00 €
<b>BILIA MINI</b>		F247400150BINE	R440400V00BI00	Diffusore in vetro con ghiera Diffuser with metal ring	130,00 €
		F247400150BLNE	R440400V00BI00	Diffusore in vetro con ghiera Diffuser with metal ring	130,00 €
		F247400150GINE	R440400V00BI00	Diffusore in vetro con ghiera Diffuser with metal ring	130,00 €
		F247400150KBNE	R440400V00BI00	Diffusore in vetro con ghiera Diffuser with metal ring	130,00 €
		F247400150NENE	R440400V00BI00	Diffusore in vetro con ghiera Diffuser with metal ring	130,00 €
		F247400150RONE	R440400V00BI00	Diffusore in vetro con ghiera Diffuser with metal ring	130,00 €
		F247400150TBNE	R440400V00BI00	Diffusore in vetro con ghiera Diffuser with metal ring	130,00 €
		F247400150VENE	R440400V00BI00	Diffusore in vetro con ghiera Diffuser with metal ring	130,00 €
		F247400550NENE	R440400V00BI00	Diffusore in vetro con ghiera Diffuser with metal ring	130,00 €
		F247400550RSNE	R440400V00BI00	Diffusore in vetro con ghiera Diffuser with metal ring	130,00 €
<b>BILIA MEDIA</b>		F247405150KBNE	R247400V00BI00	Diffusore bianco White diffuser	170,00 €
		F247405150TBNE	R247400V00BI00	Diffusore bianco White diffuser	170,00 €
		F247405550NENE	R247400V00BI00	Diffusore bianco White diffuser	170,00 €
		F247405550RSNE	R247400V00BI00	Diffusore bianco White diffuser	170,00 €
<b>BIS - TRIS</b>		F228005150TNNE	R228000V01NE00	Diffusore superiore Top diffuser	665,00 €
			R228000V02OP00	Diffusore inferiore Bottom diffuser	160,00 €
		F228005150CBNE	R228000V01BI00	Diffusore superiore Top diffuser	570,00 €
			R228000V02OP00	Diffusore inferiore Bottom diffuser	160,00 €



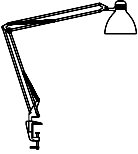





Famiglia Family		Codice prodotto finito Product code	Codice ricambio Spare part code	Descrizione Description	Prezzo Retail con IVA Retail Price VAT incl.	
<b>DARUMA</b>		F502800100BINE	R502800V01BI00	Diffusore superiore Top diffuser	175,00 €	
			R502800V02BI00	Diffusore inferiore Bottom diffuser	195,00 €	
		F502805100BINE	R502801V01BI00	Diffusore superiore Top diffuser	195,00 €	
			R502801V02BI00	Diffusore superiore Top diffuser	345,00 €	
		F502810100BINE	R502802V01BI00	Diffusore superiore Top diffuser	330,00 €	
			R502802V02BI00	Diffusore inferiore Bottom diffuser	705,00 €	
<b>EQUATORE</b>		F438900150OOWL	R438900V00BR00	Diffusore Diffuser	460,00 €	
		F438900550NEWL	R438900V00NE00	Diffusore Diffuser	460,00 €	
		F438900550RSWL	R438900V00RS00	Diffusore Diffuser	460,00 €	
		F438900550CRWL	R438900V00TR00	Diffusore Diffuser	460,00 €	
		F438905150OOWL	R438901V00BR00	Diffusore Diffuser	570,00 €	
		F438905550NEWL	R438901V00NE00	Diffusore Diffuser	570,00 €	
		F438905550RSWL	R438901V00RS00	Diffusore Diffuser	570,00 €	
		F438905550CRWL	R438901V00TR00	Diffusore Diffuser	570,00 €	
	<b>FALENA</b>		F301705150CRNE	R301600M08CR00	Corpo Body	390,00 €
				R301700B00TR00	Base Base	350,00 €
	<b>FONTANA</b>		F185300100BINE	R185300V01BI00	Diffusore superiore Top diffuser	230,00 €
				R185301V02BI00	Globo Globe	160,00 €
			R185301M00BI00	Montatura completa Complete mounting	555,00 €	
			R185301M01BI00	Crociera reggivetrol Glassholder cross	85,00 €	
			R185300T00NE00	Tastiera Switch	30,00 €	
		F185305100BINE	R185301V01BI00	Diffusore superiore Top diffuser	525,00 €	
			R185300V02BI00	Globo Globe	285,00 €	
			R185300M00BI00	Montatura completa Complete mounting	720,00 €	
			R185300M01BI00	Crociera reggivetrol Glassholder cross	115,00 €	
			R185300T00NE00	Tastiera Switch	30,00 €	

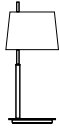

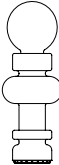
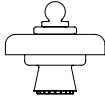
Famiglia Family		Codice prodotto finito Product code	Codice ricambio Spare part code	Descrizione Description	Prezzo Retail con IVA Retail Price VAT incl.
		F185310100BINE	R185302V01BI00	Diffusore superiore Top diffuser	1.075,00 €
			R185302V02BI00	Globo Globe	500,00 €
			R185302M00BI00	Montatura completa Complete mounting	1.185,00 €
			R248202M01BI00	Crociera reggivetrol Glassholder cross	120,00 €
			R185301T00NE00	Tastiera Switch	45,00 €
			R185300M02BI00	Riflettore Top reflector	65,00 €
<b>FONTANELLA</b>		F442305550CRNE	R442300V00TR00	Diffusore Diffuser	425,00 €
		F442305550NENE	R442300V00TR00	Diffusore Diffuser	425,00 €
		F442305550OTNE	R442300V00TR00	Diffusore Diffuser	425,00 €
		F442310550CRNE	R442301V00TR00	Diffusore Diffuser	645,00 €
		F442310550NENE	R442301V00TR00	Diffusore Diffuser	645,00 €
		F442310550OTNE	R442301V00TR00	Diffusore Diffuser	645,00 €
<b>GIOVA</b>		F268405150CRNE	R264800V02TR00	Diffusore trasparente Transparent diffuser	390,00 €
			R264800V03BI00	Diffusore bianco White diffuser	155,00 €
			R264800V01RS00	Diffusore rosa Pink diffuser	280,00 €
		F268405575OONE	R264800V02TR00	Diffusore trasparente Transparent diffuser	390,00 €
			R264801V03BI00	Diffusore bianco White diffuser	185,00 €
			R264800V01GC00	Diffusore grigio chiaro Light grey diffuser	440,00 €
		F268410150CRNE	R264801V02TR00	Diffusore trasparente Transparent diffuser	880,00 €
			R264801V03BI00	Diffusore bianco White diffuser	185,00 €
			R264801V01RS00	Diffusore rosa Pink diffuser	455,00 €
		F268410575OONE	R264801V02TR00	Diffusore trasparente Transparent diffuser	880,00 €
			R264801V03BI00	Diffusore bianco White diffuser	185,00 €
			R264801V01GC00	Diffusore grigio chiaro Light grey diffuser	500,00 €
<b>MANO</b>		F420805400NENE	R420800M00NE00	Montatura Mounting	530,00 €
			R420800V00NE00	Diffusore Diffuser	210,00 €

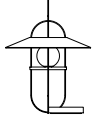
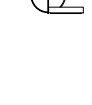
Famiglia Family		Codice prodotto finito Product code	Codice ricambio Spare part code	Descrizione Description	Prezzo Retail con IVA Retail Price VAT incl.
<b>MERIDIANO</b>		F441705550NFWL	R441700V00NE00	Diffusore Diffuser	735,00 €
		F441705550NRWL	R441700V00RS00	Diffusore Diffuser	735,00 €
		F441705550NTWL	R441700V00TR00	Diffusore Diffuser	735,00 €
<b>METAFORA</b>		F265405150BTNE	R265400V00OP00	Diffusore Diffuser	520,00 €
<b>NASKA</b>		F810700200BINE	R800400M08BI00	Corpo Body	280,00 €
			R810700B00BI00	Base Base	95,00 €
		F810700200NENE	R800400M08NE00	Corpo Body	370,00 €
			R810700B00NE00	Base Base	95,00 €
		F810700240CRNE	R800400M08CR00	Corpo Body	415,00 €
			R810700B00CR00	Base Base	145,00 €
		F810100200BINE	R800400M08BI00	Corpo Body	280,00 €
			R810100B01BI00	Morsetto Clamp	40,00 €
		F810100200NENE	R800400M08NE00	Corpo Body	370,00 €
			R810100B01NE00	Morsetto Clamp	40,00 €
		F810100240CRNE	R800400M08CR00	Corpo Body	415,00 €
			R810100B01CR00	Morsetto Clamp	40,00 €
	F810010200BINE	R800000M08BI00	Corpo Body	305,00 €	
		R810000B00BI00	Base Base	175,00 €	
	F810010200NENE	R800000M08BI00	Corpo Body	305,00 €	
		R810000B00NE00	Base Base	175,00 €	
	F810010240CRNE	R800000M08BI00	Corpo Body	305,00 €	
		R810000B00CR00	Base Base	195,00 €	
	F810010200BIWL	R802000M08BI00	Corpo Body	605,00 €	
		R810000B00BI00	Base Base	175,00 €	





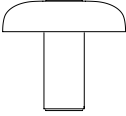

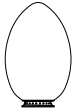
Famiglia Family	Codice prodotto finito Product code	Codice ricambio Spare part code	Descrizione Description	Prezzo Retail con IVA Retail Price VAT incl.
	F810010200NEWL	R802000M08NE00	Corpo Body	625,00 €
		R810000B00NE00	Base Base	175,00 €
	F810010240CRWL	R802000M08CR00	Corpo Body	635,00 €
		R810000B00CR00	Base Base	195,00 €
	F810010240OOWL	R802000M08OO00	Corpo Body	770,00 €
		R810000B00OO00	Base Base	230,00 €
	F81010200BINE	R800000M08BI00	Corpo Body	305,00 €
		R810100B01BI00	Morsetto Clamp	40,00 €
	F81010200NENE	R800000M08NE00	Corpo Body	410,00 €
		R810100B01NE00	Morsetto Clamp	40,00 €
	F810110240CRNE	R800000M08CR00	Corpo Body	440,00 €
		R810100B01CR00	Morsetto Clamp	40,00 €
<b>PALLINA</b> 	F443000150NENE	R440400V00BI00	Diffusore Diffuser	130,00 €
	F443000150NSNE	R440400V00BI00	Diffusore Diffuser	130,00 €
	F443000150OTNE	R440400V00BI00	Diffusore Diffuser	130,00 €
	F443000150ORNE	R440400V00BI00	Diffusore Diffuser	130,00 €
<b>PAROLA</b> 	F265805100AMNE	R265800B00TR00	Montatura Mounting	355,00 €
		R265800V00AM00	Diffusore Diffuser	340,00 €
	F265805100BINE	R265800B00TR00	Montatura Mounting	355,00 €
		R265800V00BI00	Diffusore Diffuser	340,00 €
<b>PASSION</b> 	F361000150CRNE	R361000M00CR00	Montatura Mounting	545,00 €
		R361000V00BI00	Diffusore bianco White diffuser	170,00 €
		R361000M01CR00	Crociera reggivetro Glassholder cross	65,00 €
	F361000150NCNE	R361000M00NS00	Montatura Mounting	545,00 €
		R361000V00BI00	Diffusore bianco White diffuser	170,00 €
		R361000M01NS00	Crociera reggivetro Glassholder cross	65,00 €













Famiglia Family		Codice prodotto finito Product code	Codice ricambio Spare part code	Descrizione Description	Prezzo Retail con IVA Retail Price VAT incl.
		F361005150CRNE	R361001M00CR00	Montatura Mounting	880,00 €
			R361001V00BI00	Diffusore Diffuser	315,00 €
			R361001M01CR00	Crociera reggivetro Glassholder cross	90,00 €
		F361005150NCNE	R361001M00NS00	Montatura Mounting	880,00 €
			R361001V00BI00	Diffusore Diffuser	315,00 €
			R361001M01NS00	Crociera reggivetro Glassholder cross	90,00 €
<b>PIRELLINA</b>		F278205150KBNE	R278200V00BI00	Diffusori Diffusers	285,00 €
<b>RE</b>		F443810100BIWL	R443800V00BI00	Diffusore superiore Top diffuser	465,00 €
			R443800V02BI00	Diffusore inferiore Bottom diffuser	445,00 €
			R443800V03BI00	Diffusore centrale Central diffuser	850,00 €
<b>REGINA</b>		F443710100BIWL	R443700V00BI01	Diffusore superiore Top diffuser	455,00 €
			R443700V00BI00	Diffusore centrale Central diffuser	925,00 €
<b>SETAREH</b>		F440105500NBWL	R440400V00BI00	Diffusore in vetro con ghiera / Diffuser with metal ring	130,00 €
			R440400V00BI00	Diffusore in vetro con ghiera / Diffuser with metal ring	130,00 €
		F438405500NBWL	R438G00V00BI00	Diffusore Diffuser	160,00 €
			R440400V00BI00	Diffusore in vetro con ghiera / Diffuser with metal ring	130,00 €
		F438405500OBWL	R438G00V00BI00	Diffusore Diffuser	160,00 €
			R440400V00BI00	Diffusore in vetro con ghiera / Diffuser with metal ring	130,00 €
<b>THEA</b>		F444905550NFWL	R444905V00FU00	Diffusore Diffuser	300,00 €
			R444905575RTWL	Diffusore Diffuser	300,00 €
		F444910550NFWL	R444910V00FU00	Diffusore Diffuser	490,00 €
			R444910575RTWL	Diffusore Diffuser	490,00 €
<b>THOR</b>		F329500100BINE	R329501V00BI00	Diffusore Diffuser	320,00 €
				F329505100BINE	R329500V00BI00

Famiglia Family		Codice prodotto finito Product code	Codice ricambio Spare part code	Descrizione Description	Prezzo Retail con IVA Retail Price VAT incl.
<b>TROPICO</b>		F442105585BIWL	R443101V00BI00	Diffusore Diffuser	355,00 €
		F442105585GCWL	R443101V00BI00	Diffusore Diffuser	355,00 €
		F442105585NEWL	R443101V00BI00	Diffusore Diffuser	355,00 €
		F442110585BIWL	R443102V00BI00	Diffusore Diffuser	475,00 €
		F442110585GCWL	R443102V00BI00	Diffusore Diffuser	475,00 €
		F442110585NEWL	R443102V00BI00	Diffusore Diffuser	475,00 €
<b>UOVO</b>		F264600100BINE	R264601V00BI00	Diffusore Diffuser	220,00 €
			R264601M00BI00	Montatura Mounting	205,00 €
		F264605100BINE	R264602V00BI00	Diffusore Diffuser	295,00 €
			R264602M00BI00	Montatura Mounting	230,00 €
		F264610100BINE	R264600V00BI00	Diffusore Diffuser	545,00 €
			R264600M00BI00	Montatura Mounting	285,00 €







## LAMPADE DA TERRA FLOOR LAMPS



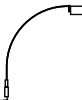



Famiglia Family		Codice prodotto finito Product code	Codice ricambio Spare part code	Descrizione Description	Prezzo Retail con IVA Retail Price VAT incl.
0024		F002430150TRNE	R002401V00TR00	Diffusori Diffusers	725,00 €
			R002401M00CR00	Montatura Mounting	1.770,00 €
3247		F324725150KBNE	R185301V01BI00	Diffusore Diffuser	525,00 €
			R324701M00NS00	Montatura Mounting	850,00 €
		F324730150KBNE	R185302V01BI00	Diffusore Diffuser	1.075,00 €
			R324700M00NS00	Montatura Mounting	1.350,00 €
EQUATORE		F439220150OOWL	R438900V00BR00	Diffusore Diffuser	460,00 €
		F439220550NEWL	R438900V00NE00	Diffusore Diffuser	460,00 €
		F439220550RSWL	R438900V00RS00	Diffusore Diffuser	460,00 €
		F439220550CRWL	R438900V00TR00	Diffusore Diffuser	460,00 €
		F439225550NEWL	R438901V00NE00	Diffusore Diffuser	570,00 €
		F439225150OOWL	R438901V00BR00	Diffusore Diffuser	570,00 €
		F439225550RSWL	R438901V00RS00	Diffusore Diffuser	570,00 €
		439225550CRWL	R438901V00TR00	Diffusore Diffuser	570,00 €
FALENA		F301825150CRNE	R301600M08CR00	Corpo Body	390,00 €
			R301800B00TR00	Base Base	655,00 €
FLÛTE		F330025150TCNE	R330000V04TC00	Diffusore per attacco E27 Diffuser for E27 socket	775,00 €







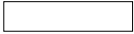

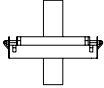

Famiglia Family		Codice prodotto finito Product code	Codice ricambio Spare part code	Descrizione Description	Prezzo Retail con IVA Retail Price VAT incl.
		F330030150TCNE	R330000M00TC00	Montatura Mounting	2.100,00 €
			R330000B00CR00	Base Base	445,00 €
			R330001V04TC00	Stelo in vetro Glass stem	1.220,00 €
<b>GALERIE</b>		F440025500QZWL	R440000V00QZ00	Diffusore Diffuser	200,00 €
			F447630500QZWL	R440000V00QZ00	Diffusore Diffuser
<b>LUMEN</b>		F248225150BINE	R185302V01BI00	Diffusore Diffuser	1.075,00 €
				R248200M00BI00	Montatura Mounting
<b>MERIDIANO</b>		F441725550NFWL	R441700V00NE00	Diffusore Diffuser	735,00 €
		F441725550NRWL	R441700V00RS00	Diffusore Diffuser	735,00 €
		F441725550NTWL	R441700V00TR00	Diffusore Diffuser	735,00 €
<b>PAROLA</b>		F268945150AMNE	R265800V00AM00	Diffusore Diffuser	340,00 €
		F268945150BINE	R265800V00BI00	Diffusore Diffuser	340,00 €

Famiglia Family		Codice prodotto finito Product code	Codice ricambio Spare part code	Descrizione Description	Prezzo Retail con IVA Retail Price VAT incl.
<b>PAROLONA</b>		F275130150BINE	R275100V00BI00	Diffusore Diffuser	415,00 €
<b>PIRELLONE</b>		F275930150KBNE	R275900V00BI00	Diffusore Singolo Single Diffuser	915,00 €
			R275901V00BI00	Diffusore Doppio Double Diffuser	1.520,00 €
			R275800M00NS00	Montatura Mounting	1.805,00 €
<b>PRIMA SIGNORA</b>		F289130150CBNE	R289100V00BI00	Diffusore Diffuser	570,00 €
<b>THEA</b>		F444930550NFWL	R444910V00FU00	Diffusore Diffuser	490,00 €
		F444930575RTWL	R444910V00TR00	Diffusore Diffuser	490,00 €
<b>SCINTILLA</b>		F272930250CRNE	RP15000V05TR00	Schermo superiore Upper protection	23,00 €
			RP15000V06TR00	Schermo inferiore Lower protection	23,00 €
			RS15000M02AL00	Riflettore Reflector	40,00 €
		F272930250NSNE	RP15000V05TR00	Schermo Superiore Upper Protection	23,00 €
			RP15000V06TR00	Schermo Inferiore Lower Protection	23,00 €
			RS15000M02AL00	Riflettore Reflector	40,00 €

## LAMPADE A PARETE E A PLAFONE WALL AND CEILING LAMPS





Famiglia Family		Codice prodotto finito Product code	Codice ricambio Spare part code	Descrizione Description	Prezzo Retail con IVA Retail Price VAT incl.	
<b>BRUCO</b>		F353845100BINE	R353800V01BI00	Diffusore superiore Top diffuser	90,00 €	
		F353845100BINE	R353800V02BI00	Diffusore inferiore Bottom diffuser	145,00 €	
<b>FALENA</b>		F301945150CRNE	R301600M08CR00	Corpo Body	390,00 €	
			R301900B02CR00	Montatura Mounting	190,00 €	
<b>FRENESI</b>		F446745550TCLE	R446745V00TR00	Diffusore Diffuser	1.450,00 €	
<b>NASKA</b>		F810340200BINE	R800400M08BI00	Corpo Body	280,00 €	
			R810300B02BI00	Attacco a parete Wall support	40,00 €	
		F810340200NENE	R800400M08NE00	Corpo Body	370,00 €	
			R810300B02NE00	Attacco a parete Wall support	40,00 €	
		F810340240CRNE	R800400M08CR00	Corpo Body	415,00 €	
			R810300B02CR00	Attacco a parete Wall support	40,00 €	
		F810350200BINE	R800000M08BI00	Corpo Body	305,00 €	
			R810300B02BI00	Attacco a parete Wall support	40,00 €	
		F810350200NENE	R800000M08NE00	Corpo Body	410,00 €	
			R810300B02NE00	Attacco a parete Wall support	40,00 €	
		F810350240CRNE	R800000M08CR00	Corpo Body	440,00 €	
			R810300B02CR00	Attacco a parete Wall support	40,00 €	
			F810350200BIWL	R802000M08BI00	Corpo Body	605,00 €
				R810300B02BI00	Attacco a parete Wall support	40,00 €
F8103450200NEWL			R802000M08NE00	Corpo Body	625,00 €	
			R810300B02NE00	Attacco a parete Wall support	40,00 €	
		F810350240CRWL	R802000M08CR00	Corpo Body	635,00 €	
			R810300B02CR00	Attacco a parete Wall support	40,00 €	





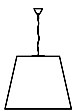
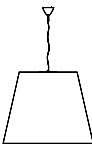
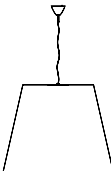
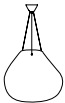
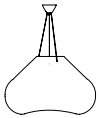
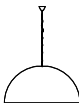
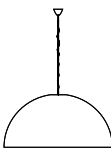

Famiglia Family		Codice prodotto finito Product code	Codice ricambio Spare part code	Descrizione Description	Prezzo Retail con IVA Retail Price VAT incl.
		F810350240OOWL	R802000M08OO00	Corpo Body	770,00 €
			R810300B02NE00	Attacco a parete Wall support	40,00 €
<b>NOBI</b>		F302345150BINE	R308600V00OP00	Diffusore Diffuser	70,00 €
			R308600M02AL00	Riflettore Reflector	85,00 €
		F302345150CRLE	R308600V00OP00	Diffusore Diffuser	70,00 €
			R308600M02AL00	Riflettore Reflector	85,00 €
		F302345150NSLE	R308600V00OP00	Diffusore Diffuser	70,00 €
			R308600M02AL00	Riflettore Reflector	85,00 €
<b>PALLINA</b>		F443060150NENE	R440400V00BI00	Diffusore Diffuser	130,00 €
		F443060150NSNE	R440400V00BI00	Diffusore Diffuser	130,00 €
		F443060150OTNE	R440400V00BI00	Diffusore Diffuser	130,00 €
		F443060150NSNE	R440400V00BI00	Diffusore Diffuser	130,00 €
<b>PAROLA</b>		F268945150AMNE	R265800V00AM00	Diffusore Diffuser	340,00 €
		F268945150BINE	R265800V00BI00	Diffusore Diffuser	340,00 €
<b>RIGA</b>		F521440260AXLE	R521401V00OP00	Diffusore Diffuser	30,00 €
		F521440260BILE	R521401V00OP00	Diffusore Diffuser	30,00 €
		F521440260NSLE	R521401V00OP00	Diffusore Diffuser	30,00 €
		F539845260AXLE	R539800V00OP00	Diffusore Diffuser	30,00 €
		F539845260NSLE	R539800V00OP00	Diffusore Diffuser	30,00 €
		F539845250BILE	R539800V00OP00	Diffusore Diffuser	30,00 €
		F521450260AXLE	R521400V00OP00	Diffusore Diffuser	45,00 €
		F521450260NSLE	R521400V00OP00	Diffusore Diffuser	45,00 €
		F521450250BILE	R521400V00OP00	Diffusore Diffuser	45,00 €
<b>SCINTILLA</b>		FP15045250CRNE	RP15000V05TR00	Schermo superiore Upper protection	23,00 €
			RP15000V06TR00	Schermo inferiore Lower protection	23,00 €
			RP15000M02AL00	Riflettore Reflector	75,00 €



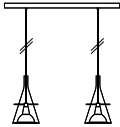
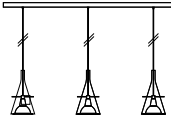

Famiglia Family		Codice prodotto finito Product code	Codice ricambio Spare part code	Descrizione Description	Prezzo Retail con IVA Retail Price VAT incl.
		FP15045250NSNE	RP15000V05TR00	Schermo superiore Upper protection	23,00 €
			RP15000V06TR00	Schermo inferiore Lower protection	23,00 €
			RP15000M02AL00	Riflettore Reflector	75,00 €
		FP30050250CRNE	RP30000V05TR00	Schermo Superiore Upper Protection	30,00 €
			RP30000V06TR00	Schermo inferiore Lower protection	30,00 €
			RP30000M02AL00:	Riflettore Reflector	75,00 €
		FP30050250NSNE	RP30000V05TR00	Schermo superiore Upper protection	30,00 €
			RP30000V06TR00	Schermo inferiore Lower protection	30,00 €
			RP30000M02AL00:	Riflettore Reflector	75,00 €
<b>SILLABA</b>		F277560150BINE	R277500V00OP00	Diffusore Diffuser	90,00 €
		F277565150BINE	R277501V00OP00	Diffusore Diffuser	165,00 €
		F277570150BINE	R277502V00OP00	Diffusore Diffuser	165,00 €
		F277570150BILE	R277502V00OP00	Diffusore Diffuser	165,00 €
<b>SILLABONE</b>		F279370150BINE	R279300V00OP00	Diffusore Diffuser	280,00 €
<b>THEA</b>		F444965550NFLE	R444985V00FU00	Diffusore Diffuser	500,00 €
		F444965575RTLE	R444985V00TR00	Diffusore Diffuser	500,00 €
		F444970550NFLE	R444990V00FU00	Diffusore Diffuser	800,00 €
		F444970575RTLE	R444990V00TR00	Diffusore Diffuser	800,00 €
<b>TROPICO</b>		F442160550NELE	R443100V00BI00	Diffusore Diffuser	265,00 €
		F442160550OOLE	R443100V00BI00	Diffusore Diffuser	265,00 €
		F442165550NELE	R443101V00BI00	Diffusore Diffuser	355,00 €
		F442165550OOLE	R443101V00BI00	Diffusore Diffuser	355,00 €
		F442170550NELE	R443102V00BI00	Diffusore Diffuser	475,00 €
		F442170550OOLE	R443102V00BI00	Diffusore Diffuser	475,00 €

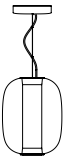

## LAMPADE A SOSPENSIONE SUSPENSION LAMPS

Famiglia Family		Codice prodotto finito Product code	Codice ricambio Spare part code	Descrizione Description	Prezzo Retail con IVA Retail Price VAT incl.
<b>0024</b>		F002485150TRNE	R002400V00TR00	Set dischi diffusori Set glass disks	1.325,00 €
<b>AMAX</b>		F544480350BINE	R544400V00BI00	Diffusore Diffuser	255,00 €
		F544485350BINE	R544401V00BI00	Diffusore Diffuser	320,00 €
		F544490350BINE	R544402V00BI00	Diffusore Diffuser	655,00 €
			R556201K00CB00	Kit disco chiusura Clousing disk kit	445,00 €
		F544495350BINE	R544403V00BI00	Diffusore Diffuser	965,00 €
			R556200K00CB00	Kit disco chiusura Clousing disk kit	545,00 €
<b>BOLLA</b>			R356700V00TR00	Diffusore Diffuser	465,00 €
			R356701V00TR00	Diffusore Diffuser	620,00 €
<b>AVICO</b>		F556180350BINE	R556100V00BI00	Diffusore bianco White diffuser	900,00 €
			R556203K00CB00	Kit disco chiusura Clousing disk kit	545,00 €
		F556185350BINE	R556101V00BI00	Diffusore bianco White diffuser	1.105,00 €
			R556200K00CB00	Kit disco chiusura Clousing disk kit	545,00 €
<b>EQUATORE</b>		F439080150OOLE	R439000V00BR00	Diffusore Diffuser	450,00 €
		F439080550NELE	R439000V00NE00	Diffusore Diffuser	450,00 €
		F439080550RSLE	R439000V00RS00	Diffusore Diffuser	450,00 €
		F439080550CRLE	R439000V00TR00	Diffusore Diffuser	450,00 €

Famiglia Family	Codice prodotto finito Product code	Codice ricambio Spare part code	Descrizione Description	Prezzo Retail con IVA Retail Price VAT incl.		
	F439085150OLE	R439001V00BR00	Diffusore Diffuser	580,00 €		
	F439085550NELE	R439001V00NE00	Diffusore Diffuser	580,00 €		
	F439085550RSLE	R439001V00RS00	Diffusore Diffuser	580,00 €		
	F439085550CRLE	R439001V00TR00	Diffusore Diffuser	580,00 €		
	F439090150OLE	R439002V00BR00	Diffusore Diffuser	950,00 €		
	F439090550NELE	R439002V00NE00	Diffusore Diffuser	950,00 €		
	F439090550RSLE	R439002V00RS00	Diffusore Diffuser	950,00 €		
	F439090550CRLE	R439002V00TR00	Diffusore Diffuser	950,00 €		
<b>FLÛTE</b>		F333780150TCNE	R333700V00TR00	Diffusore Diffuser	350,00 €	
		F333780550NENE	R333700V00TR00	Diffusore Diffuser	350,00 €	
		F333780550OTNE	R333700V00TR00	Diffusore Diffuser	350,00 €	
	F333785150TCNE	R333700V00TR00	Diffusore Diffuser	350,00 €		
		F333790150TCNE	R333700V00TR00	Diffusore Diffuser	350,00 €	
<b>GLOBO DI LUCE</b>			F364480150CRNE	R364400V00CR00	Diffusore Diffuser	330,00 €
			F364480150RMNE	R364400V00RM00	Diffusore Diffuser	345,00 €
	F364485150CRNEW	R364402V00CR00	Diffusore Diffuser	475,00 €		
	F364485150RMNE	R364402V00RM00	Diffusore Diffuser	505,00 €		
	F364490150CRNE	R364401V00CR00	Diffusore Diffuser	755,00 €		
	F364490150RMNE	R364401V00RM00	Diffusore Diffuser	780,00 €		
<b>MERIDIANO</b>		F441785550NFLE	R441700V00NE00	Diffusore Diffuser	735,00 €	
		F441785550NRLE	R441700V00RS00	Diffusore Diffuser	735,00 €	
		F441785550NTLE	R441700V00TR00	Diffusore Diffuser	735,00 €	

Famiglia Family	Codice prodotto finito Product code	Codice ricambio Spare part code	Descrizione Description	Prezzo Retail con IVA Retail Price VAT incl.	
	F441790550NFLE	R441701V00NE00	Diffusore Diffuser	1.175,00 €	
	F441790550NRLE	R441701V00RS00	Diffusore Diffuser	1.175,00 €	
	F441790550NTLE	R441701V00TR00	Diffusore Diffuser	1.175,00 €	
<b>PALLINA</b>		F443080150NENE	R440400V00BI00	Diffusore in vetro con ghiera Diffuser with metal ring	130,00 €
		F443080150NSNE	R440400V00BI00	Diffusore in vetro con ghiera Diffuser with metal ring	130,00 €
		F443080150OTNE	R440400V00BI00	Diffusore in vetro con ghiera Diffuser with metal ring	130,00 €
		F443080150ORNE	R440400V00BI00	Diffusore in vetro con ghiera Diffuser with metal ring	130,00 €
<b>PAROLA</b>		F428485100AMNE	R428400V00AM00	Diffusore Diffuser	345,00 €
		F428485100BINE	R428400V00BI00	Diffusore Diffuser	345,00 €
<b>SCINTILLA</b>		FS15085250CRNE	RP15000V05TR00	Vetro protezione superiore trasparente Upper transparent protection glass	23,00 €
			RP15000V06TR00	Vetro protezione inferiore trasparente Lower transparent protection glass	23,00 €
			RP15000V05OP00	Vetro protezione superiore sabbato Upper sandblasted protection glass	23,00 €
			RP30001V06OP00	Vetro protezione inferiore sabbato Lower sandblasted protection glass	23,00 €
			RP30000M03AX00	Molla fissaggio vetro inferiore Lower protection glass spring holder	7,00 €
			RP15000M03AX00	Molla fissaggio vetro superiore Upper protection glass spring holder	7,00 €
			RS15000M02AL00	Riflettore Reflector	40,00 €
		FS15085250NSNE	RP15000V05TR00	Vetro protezione superiore trasparente Upper transparent protection glass	23,00 €
			RP15000V06TR00	Vetro protezione inferiore trasparente Lower transparent protection glass	23,00 €
			RP15000V05OP00	Vetro protezione superiore sabbato Upper sandblasted protection glass	23,00 €
			RP30001V06OP00	Vetro protezione inferiore sabbato Lower sandblasted protection glass	23,00 €
			RP30000M03AX00	Molla fissaggio vetro inferiore Lower protection glass spring holder	7,00 €
			RP15000M03AX00	Molla fissaggio vetro superiore Upper protection glass spring holder	7,00 €
			RS15000M02AL00	Riflettore Reflector	40,00 €

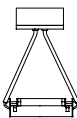
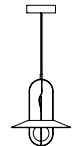
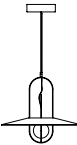
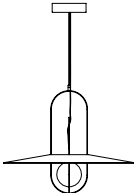
Famiglia Family	Codice prodotto finito Product code	Codice ricambio Spare part code	Descrizione Description	Prezzo Retail con IVA Retail Price VAT incl.	
	FS30090250CRNE	RP30000V05TR00	Vetro protezione superiore trasparente Upper transparent protection glass	30,00 €	
		RP30000V06TR00	Vetro protezione inferiore trasparente Lower transparent protection glass	30,00 €	
		R279100V05OP00	Vetro protezione superiore sabbiato Upper sandblasted protection glass	35,00 €	
		RP30000V06OP00	Vetro protezione inferiore sabbiato Lower sandblasted protection glass	35,00 €	
		RP30000M03AX00	Molla fissaggio vetro inferiore Lower protection glass spring holder	7,00 €	
		RP15000M03AX00	Molla fissaggio vetro superiore Upper protection glass spring holder	7,00 €	
		RS30000M02AL00	Riflettore Reflector	50,00 €	
	FS30090250NSNE	RP30000V05TR00	Vetro protezione superiore trasparente Upper transparent protection glass	30,00 €	
		RP30000V06TR00	Vetro protezione inferiore trasparente Lower transparent protection glass	30,00 €	
		R279100V05OP00	Vetro protezione superiore sabbiato Upper sandblasted protection glass	35,00 €	
		RP30000V06OP00	Vetro protezione inferiore sabbiato Lower sandblasted protection glass	35,00 €	
		RP30000M03AX00	Molla fissaggio vetro inferiore Lower protection glass spring holder	7,00 €	
		RP15000M03AX00	Molla fissaggio vetro superiore Upper protection glass spring holder	7,00 €	
		RS30000M02AL00	Riflettore Reflector	50,00 €	
<b>SETAREH</b>		F438G80550NBLE	R438G00V00BI00	Diffusore Diffuser	160,00 €
			R440400V00BI00	Diffusore in vetro con ghiera Diffuser with metal ring	130,00 €
		F438G80550OBLE	R438G00V00BI00	Diffusore Diffuser	160,00 €
			R440400V00BI00	Diffusore in vetro con ghiera Diffuser with metal ring	130,00 €
		F438G85550NBLE	R438G01V00BI00	Diffusore Diffuser	240,00 €
			R440400V00BI00	Diffusore in vetro con ghiera Diffuser with metal ring	130,00 €
		F438G85550OBLE	R438G01V00BI00	Diffusore Diffuser	240,00 €
			R440400V00BI00	Diffusore in vetro con ghiera Diffuser with metal ring	130,00 €
		F438G90550NBLE	R438G02V00BI00	Diffusore Diffuser	325,00 €
			R440400V00BI00	Diffusore in vetro con ghiera Diffuser with metal ring	130,00 €
		F438G90550OBLE	R438G02V00BI00	Diffusore Diffuser	325,00 €
			R440400V00BI00	Diffusore in vetro con ghiera Diffuser with metal ring	130,00 €

Famiglia Family		Codice prodotto finito Product code	Codice ricambio Spare part code	Descrizione Description	Prezzo Retail con IVA Retail Price VAT incl.
<b>THEA</b>		F444985550NFLE	R444985V00FU00	Diffusore Diffuser	500,00 €
		F444985575RTLE	R444985V00TR00	Diffusore Diffuser	500,00 €
		F444990550NFLE	R444990V00FU00	Diffusore Diffuser	800,00 €
		F444990575RTLE	R444990V00TR00	Diffusore Diffuser	800,00 €

## ARREDO FURNITURE

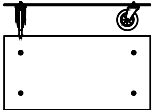
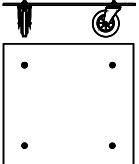
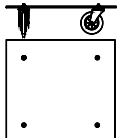
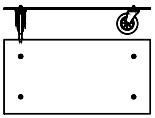
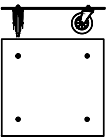
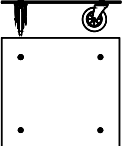
TAVOLO CON RUOTE					
	F1000TB150TR00	R265200V07TR00	Piano vetro 140x70 Glass top 140x70	770,00 €	
		R265200M10NE00	Set ruote Set of wheels	890,00 €	
	F1140TB150TR40	R265300V07TR00	Piano vetro 150x150 Glass top 150x150	1.475,00 €	
		R265200M10NE00	Set ruote Set of wheels	890,00 €	
	F1130TB150TR30	R274400V07TR00	Piano vetro 120x120 Glass top 120x120	1.075,00 €	
		R265200M10NE00	Set ruote Set of wheels	890,00 €	
	F1010TB150TR10	R274600V07TR00	Piano vetro 100x150 Glass top 100x150	1.085,00 €	
		R265200M10NE00	Set ruote Set of wheels	890,00 €	
	F1110TB150TR00	R274401V07TR00	Piano vetro 100x100 Glass top 100x100	770,00 €	
		R265200M10NE00	Set ruote Set of wheels	890,00 €	
	F1120TB150TR20	R274402V07TR00	Piano vetro 110x110 Glass top 110x110	1.065,00 €	
		R265200M10NE00	Set ruote Set of wheels	890,00 €	

# MISURE E PESI DELL'IMBALLO / PACKAGING MEASUREMENTS AND WEIGHT

## LAMPADE DA TAVOLO TABLE LAMPS



Famiglia Family	Codice Code	Descrizione Description	Dimensione Size cm A x B x H	Kg netto Kg net	Kg lordo Kg gross	
<b>3247</b>	F324700150KBNE	DIFFUSORE / DIFFUSER MONTATURA / MOUNTING	27x27x27 28x43x28	1 1,4	2 3	
	F324710150KBNE	DIFFUSORE / DIFFUSER MONTATURA / MOUNTING	42x37x42 44x54x44	0,7 4	1,2 6	
<b>ASHANGAI</b>	F418805150CBNE	LAMPADA COMPLETA / COMPLETE LAMP	60x90x60	6	14	
<b>BIANCA</b>	F430800150BILE	LAMPADA COMPLETA / COMPLETE LAMP	21x16x21	1	1,2	
	F430805150BILE	LAMPADA COMPLETA / COMPLETE LAMP	40x27,5x40	3	3,3	
	F430810150BINE	LAMPADA COMPLETA / COMPLETE LAMP	61x57x61	6	8,5	
<b>BILIA MINI</b>	F247400150BINE	LAMPADA COMPLETA / COMPLETE LAMP	19,5x31x19,5	0,6	0,9	
	F247400150BLNE	LAMPADA COMPLETA / COMPLETE LAMP	19,5x31x19,5	0,6	0,9	
	F247400150GINE	LAMPADA COMPLETA / COMPLETE LAMP	19,5x31x19,5	0,6	0,9	
	F247400150KBNE	LAMPADA COMPLETA / COMPLETE LAMP	19,5x31x19,5	0,6	0,9	
	F247400150NENE	LAMPADA COMPLETA / COMPLETE LAMP	19,5x31x19,5	0,6	0,9	
	F247400150RONE	LAMPADA COMPLETA / COMPLETE LAMP	19,5x31x19,5	0,6	0,9	
	F247400150TBNE	LAMPADA COMPLETA / COMPLETE LAMP	19,5x31x19,5	0,6	0,9	
	F247400150VENE	LAMPADA COMPLETA / COMPLETE LAMP	19,5x31x19,5	0,6	0,9	
	F247400550NENE	LAMPADA COMPLETA / COMPLETE LAMP	19,5x31x19,5	0,6	0,9	
	F247400550RSNE	LAMPADA COMPLETA / COMPLETE LAMP	19,5x31x19,5	0,6	0,9	
	<b>BILIA</b>	F247405150KBNE	DIFFUSORE / DIFFUSER MONTATURA / MOUNTING	28x30x28 18x37x18	1 0,8	1,5 1,6
		F247405150TBNE	DIFFUSORE / DIFFUSER MONTATURA / MOUNTING	28x30x28 18x37x18	1 0,8	1,5 1,6
		F247405550NENE	DIFFUSORE / DIFFUSER MONTATURA / MOUNTING	28x30x28 18x37x18	1 0,8	1,5 1,6
F247405550RSNE		DIFFUSORE / DIFFUSER MONTATURA / MOUNTING	28x30x28 18x37x18	1 0,8	1,5 1,6	
<b>BIS - TRIS</b>		F228005150CBNE	LAMPADA COMPLETA / COMPLETE LAMP	46x54x46	6,6	9,4
	F228005150TNNE	LAMPADA COMPLETA / COMPLETE LAMP	46x54x46	6,6	9,4	
<b>BLOM</b>	F425305350BINE	LAMPADA COMPLETA / COMPLETE LAMP	29x37x29	1	2	
	F425305350BLNE	LAMPADA COMPLETA / COMPLETE LAMP	29x37x29	1	2	
	F425305350GINE	LAMPADA COMPLETA / COMPLETE LAMP	29x37x29	1	2	
	F425305350GSNE	LAMPADA COMPLETA / COMPLETE LAMP	29x37x29	1	2	
	F425305350RSNE	LAMPADA COMPLETA / COMPLETE LAMP	29x37x29	1	2	
	F425305350VENE	LAMPADA COMPLETA / COMPLETE LAMP	29x37x29	1	2	
	F425305350VINE	LAMPADA COMPLETA / COMPLETE LAMP	29x37x29	1	2	
<b>CHESHIRE</b>	F425105350BINE	LAMPADA COMPLETA / COMPLETE LAMP	45,5x74x45,5	6,3	9,8	
	F425105350NENE	LAMPADA COMPLETA / COMPLETE LAMP	45,5x74x45,5	6,3	9,3	

Famiglia Family	Codice Code	Descrizione Description	Dimensione Size cm A x B x H	Kg netto Kg net	Kg lordo Kg gross
<b>DARUMA</b>	F502800100BINE	LAMPADA COMPLETA / COMPLETE LAMP	19x26x19	1	1,5
	F502805100BINE	LAMPADA COMPLETA / COMPLETE LAMP	31x41x31	2,2	3
	F502810100BINE	LAMPADA COMPLETA / COMPLETE LAMP	44x55x44	5,8	7,8
<b>EQUATORE</b>	F438900150OOWL	DIFFUSORE / DIFFUSER MONTATURA / MOUNTING	32x22,5x32 32x41x32	1,7 5,2	2,5 6,2
	F438900550CRWL	DIFFUSORE / DIFFUSER MONTATURA / MOUNTING	32x22,5x32 32x41x32	1,7 5,2	2,5 6,2
	F438900550NEWL	DIFFUSORE / DIFFUSER MONTATURA / MOUNTING	32x22,5x32 32x41x32	1,7 5,2	2,5 6,2
	F438900550RSWL	DIFFUSORE / DIFFUSER MONTATURA / MOUNTING	32x22,5x32 32x41x32	1,7 5,2	2,5 6,2
	F438905150OOWL	DIFFUSORE / DIFFUSER MONTATURA / MOUNTING	43x33,5x43 43x50x43	3,4 13	5,3 15
	F438905550CRWL	DIFFUSORE / DIFFUSER MONTATURA / MOUNTING	43x33,5x43 43x50x43	3,4 13	5,3 15
	F438905550NEWL	DIFFUSORE / DIFFUSER MONTATURA / MOUNTING	43x33,5x43 43x50x43	3,4 13	5,3 15
	F438905550RSWL	DIFFUSORE / DIFFUSER MONTATURA / MOUNTING	43x33,5x43 43x50x43	3,4 13	5,3 15
	<b>FALENA</b>	F301705150CRNE	CORPO / BODY BASE / BASE	70x10x30 27x17x27	0,2 1,3
<b>FONTANA</b>		F185300100BINE	DIFFUSORE / DIFFUSER MONTATURA / MOUNTING	27x27x27 25x25x30	0,7 1
	F185300200OTNE	DIFFUSORE / DIFFUSER MONTATURA / MOUNTING	27x27x27 25x25x30	0,7 2	1,2 2
	F185305100BINE	DIFFUSORE / DIFFUSER MONTATURA / MOUNTING	42x37x42 35x45x40	1 3	2 4
	F185305200OTNE	DIFFUSORE / DIFFUSER MONTATURA / MOUNTING	42x37x42 55x55x85	1 2	2 2
	F185310100BINE	DIFFUSORE / DIFFUSER MONTATURA / MOUNTING	54x52x54 55x55x85	4,8 7	7 8
<b>FONTANELLA</b>	F442305550CRNE	DIFFUSORE / DIFFUSER MONTATURA / MOUNTING	32,5x32,5x37,5 15x15x11	0,5 1,5	1 2
	F442305550NENE	DIFFUSORE / DIFFUSER MONTATURA / MOUNTING	32,5x32,5x37,5 15x15x11	0,5 1,5	1 2
	F442305550OTNE	DIFFUSORE / DIFFUSER MONTATURA / MOUNTING	32,5x32,5x37,5 15x15x11	0,5 1,5	1 2
	F442310550CRNE	DIFFUSORE / DIFFUSER MONTATURA / MOUNTING	32,5x32,5x37,5 15x15x11	0,5 1,5	1 2
	F442310550NENE	DIFFUSORE / DIFFUSER MONTATURA / MOUNTING	32,5x32,5x37,5 15x15x11	0,5 1,5	1 2
	F442310550OTNE	DIFFUSORE / DIFFUSER MONTATURA / MOUNTING	32,5x32,5x37,5 15x15x11	0,5 1,5	1 2
<b>GIOVA</b>	F268405150CRNE	LAMPADA COMPLETA / COMPLETE LAMP	41x78x41	5	7
	F268405575OONE	LAMPADA COMPLETA / COMPLETE LAMP	41x78x41	5	7
	F268410150CRNE	LAMPADA COMPLETA / COMPLETE LAMP	56x83x56	14	17,5
	F268410575OONE	LAMPADA COMPLETA / COMPLETE LAMP	56x83x56	14	17,5
<b>KINX</b>	F431205200NEWL	LAMPADA COMPLETA / COMPLETE LAMP	22x47,5x77,5	2,5	4
<b>LASOSPESA</b>	F443105150TRWL	LAMPADA COMPLETA / COMPLETE LAMP	20x45x20	0,5	2,5
<b>LOOP</b>	F542910200AXLE	LAMPADA COMPLETA / COMPLETE LAMP	55x26x55	8,5	10
<b>MANO</b>	F420805400NELE	MONTATURA / MOUNTING	28x48x26	3	4
		DIFFUSORE / DIFFUSER	42x41x42	0,3	1,5

Famiglia Family	Codice Code	Descrizione Description	Dimensione Size cm A x B x H	Kg netto Kg net	Kg lordo Kg gross
<b>MATRIX</b>	F444305250BIWL	GABBIA INFERIORE / LOWER CAGE	32x32x23,5	2,8	3,7
		GABBIA SUPERIORE / UPPER CAGE	32x32x23,5	2,8	3,7
		DIFFUSORE / DIFFUSER	30x30x32	1,6	2,5
	F444305250OBWL	GABBIA INFERIORE / LOWER CAGE	32x32x23,5	2,8	3,7
		GABBIA SUPERIORE / UPPER CAGE	32x32x23,5	2,8	3,7
		DIFFUSORE / DIFFUSER	30x30x32	1,6	2,5
	F444310250OBWL	GABBIA INFERIORE / LOWER CAGE	32x32x23,5	2,8	3,7
		GABBIA CENTRALE / CENTRAL CAGE	32x32x23,5	2,8	3,7
		GABBIA CENTRALE / CENTRAL CAGE	32x32x23,5	2,8	3,7
		GABBIA SUPERIORE / UPPER CAGE	32x32x23,5	2,8	3,7
		DIFFUSORE / DIFFUSER	30x30x32	1,6	2,5
	F444310250OBWL	GABBIA INFERIORE / LOWER CAGE	32x32x23,5	2,8	3,7
GABBIA CENTRALE / CENTRAL CAGE		32x32x23,5	2,8	3,7	
GABBIA CENTRALE / CENTRAL CAGE		32x32x23,5	2,8	3,7	
GABBIA SUPERIORE / UPPER CAGE		32x32x23,5	2,8	3,7	
DIFFUSORE / DIFFUSER		30x30x32	1,6	2,5	
<b>MERIDIANO</b>	F441705550NFWL	DIFFUSORE / DIFFUSER	39x39x49	2,8	4,8
		MONTATURA / MOUNTING	28x29,5x52,5	2,7	4,2
	F441705550NRWL	DIFFUSORE / DIFFUSER	39x39x49	2,8	4,8
		MONTATURA / MOUNTING	28x29,5x52,5	2,7	4,2
	F441705550NTWL	DIFFUSORE / DIFFUSER	39x39x49	2,8	4,8
		MONTATURA / MOUNTING	28x29,5x52,5	2,7	4,2
<b>METAFORA</b>	F265405150BTNE	MONTATURA / MOUNTING	52x46x52	5,5	6,5
		DIFFUSORE / DIFFUSER	52x32x52	5	6
<b>NASKA</b>	F810010200BINE	CORPO / BODY	18x67x28	2,8	3,5
		BASE / BASE	29x21x29	6,6	7,2
	F810010200BIWL	CORPO / BODY	18x67x28	2,8	3,5
		BASE / BASE	29x21x29	6,6	7,2
	F810010200NENE	CORPO / BODY	18x67x28	2,8	3,5
		BASE / BASE	29x21x29	6,6	7,2
	F810010200NEWL	CORPO / BODY	18x67x28	2,8	3,5
		BASE / BASE	29x21x29	6,6	7,2
	F810010240CRNE	CORPO / BODY	18x67x28	2,8	3,5
		BASE / BASE	29x21x29	6,6	7,2
	F810010240CRWL	CORPO / BODY	18x67x28	2,8	3,5
		BASE / BASE	29x21x29	6,6	7,2
	F810010240OOWL	CORPO / BODY	18x67x28	2,8	3,5
		BASE / BASE	29x21x29	6,6	7,2
	F810100200BINE	CORPO / BODY	23x38x20	1,9	2,5
		MORSETTO / CLAMP	15x9x13	0,1	0,2
	F810100200NENE	CORPO / BODY	23x38x20	1,9	2,5
		MORSETTO / CLAMP	15x9x13	0,1	0,2
	F810100240CRNE	CORPO / BODY	23x38x20	1,9	2,5
		MORSETTO / CLAMP	15x9x13	0,1	0,2
	F810110200BINE	CORPO / BODY	18x67x28	2,8	3,5
		MORSETTO / CLAMP	15x9x13	0,1	0,2
	F810110200BIWL	CORPO / BODY	18x67x28	2,8	3,5
		MORSETTO / CLAMP	15x9x13	0,1	0,2
F810110200NENE	CORPO / BODY	18x67x28	2,8	3,5	
	MORSETTO / CLAMP	15x9x13	0,1	0,2	
F810110200NEWL	CORPO / BODY	18x67x28	2,8	3,5	
	MORSETTO / CLAMP	15x9x13	0,1	0,2	
F810110240CRNE	CORPO / BODY	18x67x28	2,8	3,5	
	MORSETTO / CLAMP	15x9x13	0,1	0,2	
F810110240CRWL	CORPO / BODY	18x67x28	2,8	3,5	
	MORSETTO / CLAMP	15x9x13	0,1	0,2	



Famiglia Family	Codice Code	Descrizione Description	Dimensione Size cm A x B x H	Kg netto Kg net	Kg lordo Kg gross
	F810110240OOWL	CORPO / BODY MORSETTO / CLAMP	18x67x28 15x9x13	2,8 0,1	3,5 0,2
	F810700200BINE	CORPO / BODY BASE / BASE	23x38x20 26x21x26	1,9 3	2,5 3,5
	F810700200NENE	CORPO / BODY BASE / BASE	23x38x20 26x21x26	1,9 3	2,5 3,5
	F810700240CRNE	CORPO / BODY BASE / BASE	23x38x20 26x21x26	1,9 3	2,5 3,5
<b>OORT</b>	OORT00020	LAMPADA COMPLETA / COMPLETE LAMP	41x41x46	5,5	7,5
	OORT00021	LAMPADA COMPLETA / COMPLETE LAMP	41x41x46	5,5	7,5
<b>PALLINA</b>	F443000150NENE	LAMPADA COMPLETA / COMPLETE LAMP	19x19x19	1	1,5
	F443000150NSNE	LAMPADA COMPLETA / COMPLETE LAMP	19x19x19	1	1,5
	F443000150ORNE	LAMPADA COMPLETA / COMPLETE LAMP	19x19x19	1	1,5
	F443000150OTNE	LAMPADA COMPLETA / COMPLETE LAMP	19x19x19	1	1,5
<b>PAROLA</b>	F265805100AMNE	MONTATURA / MOUNTING DIFFUSORE / DIFFUSER	54x29x27 34,5x27x34,5	1 0,6	2,2 1,4
	F265805100BINE	MONTATURA / MOUNTING DIFFUSORE / DIFFUSER	54x29x27 34,5x27x34,5	1 0,6	2,2 1,4
<b>PASSION</b>	F361000150CRNE	MONTATURA / MOUNTING DIFFUSORE / DIFFUSER	25x43x25 25x19,5x25	2 0,6	2,6 1,2
	F361000150NCNE	MONTATURA / MOUNTING DIFFUSORE / DIFFUSER	25x43x25 25x19,5x25	2 0,6	2,6 1,2
	F361005150CRNE	MONTATURA / MOUNTING DIFFUSORE / DIFFUSER	33,1x64,1x33,1 37x26x37	4,5 1,5	5,51 2,2
	F361005150NCNE	MONTATURA / MOUNTING DIFFUSORE / DIFFUSER	33,1x64,1x33,1 37x26x37	4,5 1,5	5,51 2,2
<b>PINECONE</b>	F436405550CBNE	LAMPADA COMPLETA / COMPLETE LAMP	40x40x40	5,5	6,5
	F436405550TCNE	LAMPADA COMPLETA / COMPLETE LAMP	40x40x40	5,5	6,5
	F436405575OBNE	LAMPADA COMPLETA / COMPLETE LAMP	40x40x40	5,5	6,5
	F436405575TONE	LAMPADA COMPLETA / COMPLETE LAMP	40x40x40	5,5	6,5
	F434010550CBNE	LAMPADA COMPLETA / COMPLETE LAMP	64x58x64	11	14
	F434010550TCNE	LAMPADA COMPLETA / COMPLETE LAMP	64x58x64	11	14
	F434010575OBNE	LAMPADA COMPLETA / COMPLETE LAMP	64x58x64	11	14
	F434010575TONE	LAMPADA COMPLETA / COMPLETE LAMP	64x58x64	11	14
<b>PIRELLINA</b>	F278205150KBNE	MONTATURA / MOUNTING DIFFUSORI / DIFFUSERS	21x10x43 32x16x34	1 1	1,4 1,4
<b>RE</b>	F443810100BIWL	MONTATURA / MOUNTING DIFFUSORE / DIFFUSER	41,5x41,5x72 35,5x38,5x35,5	8 2	9,5 3
<b>REGINA</b>	F443710100BIWL	MONTATURA / MOUNTING DIFFUSORI / DIFFUSERS DIFFUSORE CENTRALE/CENTRAL DIFFUSER	37,5x37,5x46 29x29x24,5 57x57x18,5	5,5 1 2,5	6,5 2 4,5
<b>SETAREH</b>	F440105500NBWL	LAMPADA COMPLETA / COMPLETE LAMP	50,5x52x55	3	4,5
	F440105500OBWL	LAMPADA COMPLETA / COMPLETE LAMP	50,5x52x55	3	4,5
	F438405500NBWL	MONTATURA / MOUNTING DIFFUSORE / DIFFUSER	27,5x80x36,5 50,5x8,5x50,5	3 0,9	4,5 2
	F438405500OBWL	MONTATURA / MOUNTING DIFFUSORE / DIFFUSER	27,5x80x36,5 50,5x8,5x50,5	3 0,9	4,5 2
<b>THEA</b>	F444905550NFWL	MONTATURA / MOUNTING DIFFUSORE / DIFFUSER	22x22x44,5 28,7x5x28,7x24	3,1 1,1	4 1,8
	F444905575RTWL	MONTATURA / MOUNTING DIFFUSORE / DIFFUSER	22x22x44,5 28,7x5x28,7x24	3,1 1,1	4 1,8

Famiglia Family	Codice Code	Descrizione Description	Dimensione Size cm A x B x H	Kg netto Kg net	Kg lordo Kg gross
	F444910550NFWL	MONTATURA / MOUNTING DIFFUSORE / DIFFUSER	37,5x37,5x58,8 42,5x42,5x33,5	8,7 2,5	10,5 4,2
	F444910575RTWL	MONTATURA / MOUNTING DIFFUSORE / DIFFUSER	37,5x37,5x58,8 42,5x42,5x33,5	8,7 2,5	10,5 4,2
<b>THOR</b>	F329500100BINE	LAMPADA COMPLETA / COMPLETE LAMP	40x21x29	1,5	2
	F329505100BINE	LAMPADA COMPLETA / COMPLETE LAMP	47x23x32	2	2,8
<b>TROPICO</b>	F442105585BIWL	MONTATURA / MOUNTING DIFFUSORE / DIFFUSER	35x35x42 44x44x21	8,7 2	10,5 3,2
	F442105585GCWL	MONTATURA / MOUNTING DIFFUSORE / DIFFUSER	35x35x42 44x44x21	8,7 2	10,5 3,2
	F442105585NEWL	MONTATURA / MOUNTING DIFFUSORE / DIFFUSER	35x35x42 44x44x21	8,7 2	10,5 3,2
	F442110585BIWL	MONTATURA / MOUNTING DIFFUSORE / DIFFUSER	47x47x48,5 56x56x21	19,5 3,5	23,5 5,5
	F442110585GCWL	MONTATURA / MOUNTING DIFFUSORE / DIFFUSER	47x47x48,5 56x56x21	19,5 3,5	23,5 5,5
	F442110585NEWL	MONTATURA / MOUNTING DIFFUSORE / DIFFUSER	47x47x48,5 56x56x21	19,5 3,5	23,5 5,5
<b>UOVO</b>	F264600100BINE	MONTATURA / MOUNTING DIFFUSORE / DIFFUSER	15x10x15 24x40x24	0,2 1	0,3 1,5
	F264605100BINE	MONTATURA / MOUNTING DIFFUSORE / DIFFUSER	15x10x15 42x50x42	0,2 2	0,3 4
	F264610100BINE	MONTATURA / MOUNTING DIFFUSORE / DIFFUSER	20x15x20 49x68x49	0,4 5,2	0,6 8,2
<b>UOVO RIC. / REC.</b>	F264600150BIBW	MONTATURA / MOUNTING DIFFUSORE / DIFFUSER	15x10x15 24x40x24	0,2 1	0,3 1,5
<b>UOVO OUTDOOR</b>	F264613370BINE	MONTATURA / MOUNTING DIFFUSORE / DIFFUSER	20x15x20 55x55x85	0,4 4,2	0,6 6
<b>DEMI VOLÉE</b>	F429000350BIWL	CORPO / BODY BASE / BASE	26x6x64 27x8x27	0,5 3	1 3,5
	F429000350GIWL	CORPO / BODY BASE / BASE	26x6x64 27x8x27	0,6 3	1 3,5
	F429000350GSWL	CORPO / BODY BASE / BASE	26x6x64 27x8x27	0,6 3	1 3,5
<b>VOLÉE</b>	F429005350BIWL	CORPO / BODY BASE / BASE	108x7x28 27x8x27	3 3	3,5 3,5
	F429005350GIWL	CORPO / BODY BASE / BASE	108x7x28 27x8x27	3 3	3,5 3,5
	F429005350GSWL	CORPO / BODY BASE / BASE	108x7x28 27x8x27	3 3	3,5 3,5

## LAMPADE DA TERRA FLOOR LAMPS



Famiglia Family	Codice Code	Descrizione Description	Dimensione Size cm A x B x H	Kg netto Kg net	Kg lordo Kg gross
<b>0024</b>	F002430150TRNE	MONTATURA / MOUNTING	48x200x48	26	28
		DIFFUSORE / DIFFUSER	61x21x61	15,5	17,3
<b>3247</b>	F324725150KBNE	MONTATURA / MOUNTING	43x145x44	4,5	9,5
		DIFFUSORE / DIFFUSER	42x37x42	0,7	1,2
	F324730150KBNE	MONTATURA / MOUNTING	52x186x56	15	23
		DIFFUSORE / DIFFUSER	54x52x54	4,8	7
<b>ALICANTO</b>	F443630160OBWL	DIFFUSORE / DIFFUSER	39x39x40	2,7	4,2
		CORPO / BOBY	62x146x65	10	20
		STELO / STEM	79x240x39	3,5	14
		BASE / BASE	54x19x22	30	31,2
	F443630160ONWL	DIFFUSORE / DIFFUSER	39x39x40	2,7	4,2
		CORPO / BOBY	62x146x65	10	20
		STELO / STEM	79x240x39	3,5	14
		BASE / BASE	54x19x22	30	31,2
<b>BIANCA</b>	F430930150BINE	MONTATURA / MOUNTING	48x159x48	13,6	18,6
		DIFFUSORE / DIFFUSER	61x57x61	5	7,5
<b>CHESHIRE</b>	F425225350BINE	LAMPADA COMPLETA / COMPLETE LAMP	50x163x49	6,6	13,3
	F425225350NENE	LAMPADA COMPLETA / COMPLETE LAMP	50x163x49	6,7	13,4
<b>EQUATORE</b>	F439220150OOWL	MONTATURA / MOUNTING	31,5x31,5x132	9,5	12
		DIFFUSORE / DIFFUSER	32x22,5x32	1,7	2,5
	F439220550CRWL	MONTATURA / MOUNTING	31,5x31,5x132	9,5	12
		DIFFUSORE / DIFFUSER	32x22,5x32	1,7	2,5
	F439220550NEWL	MONTATURA / MOUNTING	31,5x31,5x132	9,5	12
		DIFFUSORE / DIFFUSER	32x22,5x32	1,7	2,5
	F439220550RSWL	MONTATURA / MOUNTING	31,5x31,5x132	9,5	12
		DIFFUSORE / DIFFUSER	32x22,5x32	1,7	2,5
	F439225150OOWL	MONTATURA / MOUNTING	43,5x43,5x165	19	23
DIFFUSORE / DIFFUSER		43x33,5x43	3,4	5,3	
F439225550CRWL	MONTATURA / MOUNTING	43,5x43,5x165	19	23	
	DIFFUSORE / DIFFUSER	43x33,5x43	3,4	5,3	
F439225550NEWL	MONTATURA / MOUNTING	43,5x43,5x165	19	23	
	DIFFUSORE / DIFFUSER	43x33,5x43	3,4	5,3	
F439225550RSWL	MONTATURA / MOUNTING	43,5x43,5x165	19	23	
	DIFFUSORE / DIFFUSER	43x33,5x43	3,4	5,3	
<b>FALENA</b>	F301825150CRNE	CORPO / BODY	70x10x30	0,2	1
		BASE / BASE	14x80x35	3	4,5
<b>FLÛTE</b>	F330025150TCNE	LAMPADA COMPLETA / COMPLETE LAMP	31x202x31	6	10,1
	F330030150TCNE	MONTATURA / MOUNTING	43x217x41	11	14,5
		BASE / BASE	47x7x47	10	12
<b>GALERIE</b>	F440025500QZWL	MONTATURA / MOUNTING	30x190x30	5	7
		DIFFUSORE / DIFFUSER	30x15x15	0,5	0,6
		BASE / BASE	28x32x25	14	18
	F447630500QZWL	MONTATURA / MOUNTING	30x190x30	5	9
		DIFFUSORE / DIFFUSER	25x32x15	1,5	18
		BASE / BASE	28x32x25	14	18
<b>LUMEN</b>	F248225150BINE	MONTATURA / MOUNTING	57x181x53,5	10,7	18
		DIFFUSORE / DIFFUSER	54x52x54	4,8	7
<b>LUMINATOR</b>	F005630200NSWL	LAMPADA COMPLETA / COMPLETE LAMP	35,5x210x35,5	13	18,4
	F005630210BIWL	LAMPADA COMPLETA / COMPLETE LAMP	35,5x210x35,5	13	18,4
	F005630210BLWL	LAMPADA COMPLETA / COMPLETE LAMP	35,5x210x35,5	13	18,4

Famiglia Family	Codice Code	Descrizione Description	Dimensione Size cm A x B x H	Kg netto Kg net	Kg lordo Kg gross
<b>MERIDIANO</b>	F441725550NFWL	MONTATURA / MOUNTING DIFFUSORE / DIFFUSER	180x44x42 39x39x49	15 2,8	21,2 4,8
	F441725550NRWL	MONTATURA / MOUNTING DIFFUSORE / DIFFUSER	180x44x42 39x39x49	15 2,8	21,2 4,8
	F441725550NTWL	MONTATURA / MOUNTING DIFFUSORE / DIFFUSER	180x44x42 39x39x49	15 2,8	21,2 4,8
<b>NASKA</b>	F810525200BINE	LAMPADA COMPLETA / COMPLETE LAMP	165x70x70	63	65
	F810525200NENE	LAMPADA COMPLETA / COMPLETE LAMP	165x70x70	63	65
<b>OORT</b>	OORT00001	LAMPADA COMPLETA / COMPLETE LAMP	120x25x10	3	4
	OORT00010	LAMPADA COMPLETA / COMPLETE LAMP	120x25x10	3	4
	OORT00002	LAMPADA COMPLETA / COMPLETE LAMP	160x25x10	3	4
	OORT00011	LAMPADA COMPLETA / COMPLETE LAMP	160x25x10	3	4
<b>PAROLA</b>	F265925100AMNE	MONTATURA / MOUNTING DIFFUSORE / DIFFUSER	20x145x35 34,5x27x34,5	4,5 0,6	6 1,4
	F265925100BINE	MONTATURA / MOUNTING DIFFUSORE / DIFFUSER	20x145x35 34,5x27x34,5	4,5 0,6	6 1,4
<b>PAROLONA</b>	F275130150BINE	BASE / BASE	40x40x10	4	5
		DIFFUSORE / DIFFUSER	41x41x36	3	2
		CORPO / BODY	15x15x220	7	9
<b>PIRELLONE</b>	F275930150KBNE	MONTATURA / MOUNTING DIFFUSORE / DIFFUSER	48x192x48 52x20x192	12 6,7	15 11,3
<b>PRIMA SIGNORA</b>	F289130150CBNE	MONTATURA / MOUNTING DIFFUSORE / DIFFUSER	17x14,5x160 55x55x55	6 7,5	8 10
<b>RILUMINATOR</b>	F425930350BIWL	LAMPADA COMPLETA / COMPLETE LAMP	38x192,5x38	13	16,5
<b>SCINTILLA</b>	F272930250CRNE	LAMPADA COMPLETA / COMPLETE LAMP	35x196x30	7	9,2
	F272930250NSNE	LAMPADA COMPLETA / COMPLETE LAMP	35x196x30	7	9,2
<b>THEA</b>	F444930550NFWL	MONTATURA / MOUNTING DIFFUSORE / DIFFUSER	41x174,5x41 42,5x42,5x33,5	2,5	4,2
	F444930575RTWL	MONTATURA / MOUNTING DIFFUSORE / DIFFUSER	41x174,5x41 42,5x42,5x33,5	2,5	4,2
<b>TRIPOD</b>	F439825150NENE	LAMPADA COMPLETA / COMPLETE LAMP	78x22x174	7,5	17
<b>VERTIGO</b>	F553130240CRWL	LAMPADA COMPLETA / COMPLETE LAMP	40x220x40	11	13,5
<b>YUMI</b>	F414330900NEWL	BASE / BASE	60x10x60	18,5	20
		CORPO / BODY	320x95x15	2,5	11
	F414330200BIWL	BASE / BASE CORPO / BODY	60x10x60 320x95x15	18,5 2,5	20 11

# LAMPADE A PARETE E A PLAFONE

## WALL AND CEILING LAMPS



Famiglia Family	Codice Code	Descrizione Description	Dimensione Size cm A x B x H	Kg netto Kg net	Kg lordo Kg gross
<b>ALICANTO</b>	F443645160NEWL	MONTATURA / MOUNTING DIFFUSORE / DIFFUSER	182x109x26 28x28x28	7 0,5	9,5 1,7
	F443650160NEWL	MONTATURA / MOUNTING DIFFUSORE / DIFFUSER	248x140x26 28x28x28	15 0,5	18 1,7
<b>APEX</b>	F431145200BILE	LAMPADA COMPLETA / COMPLETE LAMP	13,5x13,5x113	2,0	3,0
	F431145200NELE	LAMPADA COMPLETA / COMPLETE LAMP	13,5x13,5x113	2,0	3,0
<b>BIANCA</b>	F432860150BILE	LAMPADA COMPLETA / COMPLETE LAMP	21x16x21	1	1,1
	F432865150BILE	LAMPADA COMPLETA / COMPLETE LAMP	40x27,5x40	3	3,3
	F432870150BINE	LAMPADA COMPLETA / COMPLETE LAMP	61x57x61	6	8,5
<b>BONNET</b>	F443245200BILE	LAMPADA COMPLETA / COMPLETE LAMP	23x20x35	1	1,3
	F443345200BILE	LAMPADA COMPLETA / COMPLETE LAMP	23x20x35	1	1,3
	F443245230ALLE	LAMPADA COMPLETA / COMPLETE LAMP	20x20x35	1	1,3
	F443345200ALLE	LAMPADA COMPLETA / COMPLETE LAMP	23x20x35	1	1,3
<b>BRUCO</b>	F353845100BINE	LAMPADA COMPLETA / COMPLETE LAMP	14,5x17x29,5	1,5	2,5
<b>FALENA</b>	F301945150CRNE	CORPO / BODY ATTACCO A PARETE / WALL ATTACHMENT	70x10x30 19,5x7,5x16,5	0,2 0,4	1 0,6
	<b>FLEX</b>	F431045200BILE	LAMPADA COMPLETA / COMPLETE LAMP	22x16x41	1,7
	F431045200NELE	LAMPADA COMPLETA / COMPLETE LAMP	22x16x41	1,7	2,2
	<b>FONTANELLA</b>	F447745550CRNE	DIFFUSORE / DIFFUSER MONTATURA / MOUNTING	32,5x32,5x37,5 15,8x15,8x16,2	0,5 0,2
F447745550NENE		DIFFUSORE / DIFFUSER MONTATURA / MOUNTING	32,5x32,5x37,5 15,8x15,8x16,2	0,5 0,2	1 0,4
F447745550OTNE		DIFFUSORE / DIFFUSER MONTATURA / MOUNTING	32,5x32,5x37,5 15,8x15,8x16,2	0,5 0,2	1 0,4
F447750550CRNE		DIFFUSORE / DIFFUSER MONTATURA / MOUNTING	48,5x48,5x27,5 15,8x15,8x16,2	0,5 0,4	1 0,6
F447750550NENE		DIFFUSORE / DIFFUSER MONTATURA / MOUNTING	48,5x48,5x27,5 15,8x15,8x16,2	0,5 0,4	1 0,6
F447750550OTNE		DIFFUSORE / DIFFUSER MONTATURA / MOUNTING	48,5x48,5x27,5 15,8x15,8x16,2	0,5 0,4	1 0,6
<b>FRENESI</b>	F446745550TCLE	DIFFUSORI / DIFFUSERS MONTATURA / MOUNTING	16x16x80 80x15,5x14,5	6,2 2	6,8 3
	<b>GALERIE</b>	F439945500QZLE	MONTATURA / MOUNTING DIFFUSORE / DIFFUSER	19x23x19 30x15x15	2,5 0,5
<b>IO</b>		F429945200BILE	LAMPADA COMPLETA / COMPLETE LAMP	14x13,5x20,5	0,4
	F429945200BLLE	LAMPADA COMPLETA / COMPLETE LAMP	14x13,5x20,5	0,4	0,5
	F429945200GSLE	LAMPADA COMPLETA / COMPLETE LAMP	14x13,5x20,5	0,4	0,5
	F429945200ROLE	LAMPADA COMPLETA / COMPLETE LAMP	14x13,5x20,5	0,4	0,5
<b>LUNAIRE</b>	F424665360ONLE	MONTATURA / MOUNTING TAPPO / PLUG	86x20x86 45x30x45	6,8 1,5	10,5 2,3
	F424665360RNLE	MONTATURA / MOUNTING TAPPO / PLUG	86x20x86 45x30x45	5,3 1,5	9 2,3
	F424665370OOLE	MONTATURA / MOUNTING TAPPO / PLUG	86x20x86 45x30x45	6,8 1,5	10,5 2,3
	F424665370RMLE	MONTATURA / MOUNTING TAPPO / PLUG	86x20x86 45x30x45	5,3 1,5	9 2,3
	F424665350BILE	LAMPADA COMPLETA / COMPLETE LAMP	86x20x86	6,8	10,5

Famiglia Family	Codice Code	Descrizione Description	Dimensione Size cm A x B x H	Kg netto Kg net	Kg lordo Kg gross
	F424665350NELE	LAMPADA COMPLETA / COMPLETE LAMP	86x20x86	6,8	10,5
	F424660350BILE	LAMPADA COMPLETA / COMPLETE LAMP	56x57x16,5	2	4,5
<b>NASKA</b>	F810340200BINE	CORPO / BODY ATTACCO A PARETE / WALL ATTACHMENT	23x38x20 13x9x15	1,9 0,2	2,5 0,3
	F810340200NENE	CORPO / BODY ATTACCO A PARETE / WALL ATTACHMENT	23x38x20 13x9x15	1,9 0,2	2,5 0,3
	F810340240CRNE	CORPO / BODY ATTACCO A PARETE / WALL ATTACHMENT	23x38x20 13x9x15	1,9 0,2	2,5 0,3
	F810350200BINE	CORPO / BODY ATTACCO A PARETE / WALL ATTACHMENT	18x67x28 13x9x15	2,8 0,2	3,5 0,3
	F810350200NENE	CORPO / BODY ATTACCO A PARETE / WALL ATTACHMENT	18x67x28 13x9x15	2,8 0,2	3,5 0,3
	F810350240CRNE	CORPO / BODY ATTACCO A PARETE / WALL ATTACHMENT	18x67x28 13x9x15	2,8 0,2	3,5 0,3
	F810350200BIWL	CORPO / BODY ATTACCO A PARETE / WALL ATTACHMENT	18x67x28 13x9x15	2,8 0,2	3,5 0,3
	F810350200NEWL	CORPO / BODY ATTACCO A PARETE / WALL ATTACHMENT	18x67x28 13x9x15	2,8 0,2	3,5 0,3
	F810350240CRWL	CORPO / BODY ATTACCO A PARETE / WALL ATTACHMENT	18x67x28 13x9x15	2,8 0,2	3,5 0,3
	F810350240OOWL	CORPO / BODY ATTACCO A PARETE / WALL ATTACHMENT	18x67x28 13x9x15	2,8 0,2	3,5 0,3
<b>NOBI</b>	F302345150BINE	LAMPADA COMPLETA / COMPLETE LAMP	44,5x17x13,5	0,5	0,9
	F302345150CRLE	LAMPADA COMPLETA / COMPLETE LAMP	44,5x17x13,5	0,5	0,9
	F302345150NSLE	LAMPADA COMPLETA / COMPLETE LAMP	44,5x17x13,5	0,5	0,9
<b>OORT</b>	OORT00030	LAMPADA COMPLETA / COMPLETE LAMP	41x18x22	1,2	1,8
	OORT00031	LAMPADA COMPLETA / COMPLETE LAMP	41x18x22	1,2	1,8
	OORT00040	LAMPADA COMPLETA / COMPLETE LAMP	41x41x46	5	7
	OORT00041	LAMPADA COMPLETA / COMPLETE LAMP	41x41x46	5	7
<b>PALLINA</b>	F443060150NENE	LAMPADA COMPLETA / COMPLETE LAMP	19x19x19	1	1,5
	F443060150NSNE	LAMPADA COMPLETA / COMPLETE LAMP	19x19x19	1	1,5
	F443060150ORNE	LAMPADA COMPLETA / COMPLETE LAMP	19x19x19	1	1,5
	F443060150OTNE	LAMPADA COMPLETA / COMPLETE LAMP	19x19x19	1	1,5
<b>PANGEN</b>	F419766350BINE	LAMPADA COMPLETA / COMPLETE LAMP	67x30x67	3,5	4,5
	F419766350NENE	LAMPADA COMPLETA / COMPLETE LAMP	67x30x67	3,5	4,5
	F419766350RONE	LAMPADA COMPLETA / COMPLETE LAMP	67x30x67	3,5	4,5
<b>PAROLA</b>	F268945150AMNE	MONTATURA / MOUNTING DIFFUSORE / DIFFUSER	27x11x24 34,5x27x34,5	0,4 0,6	0,7 1,4
	F268945150BINE	MONTATURA / MOUNTING DIFFUSORE / DIFFUSER	27x11x24 34,5x27x34,5	0,4 0,6	0,7 1,4
<b>RIGA</b>	F521440250BILE	LAMPADA COMPLETA / COMPLETE LAMP	14,5x14,5x43	1,1	1,3
	F521440260AXLE	LAMPADA COMPLETA / COMPLETE LAMP	14,5x14,5x43	1,1	1,3
	F521440260NSLE	LAMPADA COMPLETA / COMPLETE LAMP	14,5x14,5x43	1,1	1,3
	F521450250BILE	LAMPADA COMPLETA / COMPLETE LAMP	16x14x80	2,2	2,5
	F521450260AXLE	LAMPADA COMPLETA / COMPLETE LAMP	16x14x80	2,2	2,5
	F521450260NSLE	LAMPADA COMPLETA / COMPLETE LAMP	16x14x80	2,2	2,5
	F539845250BILE	LAMPADA COMPLETA / COMPLETE LAMP	13x13x60	1,8	2,5
	F539845260AXLE	LAMPADA COMPLETA / COMPLETE LAMP	13x13x60	1,8	2,5
	F539845260NSLE	LAMPADA COMPLETA / COMPLETE LAMP	13x13x60	1,8	2,5
	F521440250BINE	LAMPADA COMPLETA / COMPLETE LAMP	14,5x14x43	1,1	1,3

Famiglia Family	Codice Code	Descrizione Description	Dimensione Size cm A x B x H	Kg netto Kg net	Kg lordo Kg gross
<b>SCINTILLA</b>	FP15045250CRNE	LAMPADA COMPLETA / COMPLETE LAMP	28x26x20	0,4	0,9
	FP15045250NSNE	LAMPADA COMPLETA / COMPLETE LAMP	20x28x26	0,4	1,8
	FP30050250CRNE	LAMPADA COMPLETA / COMPLETE LAMP	28x26x20	0,4	0,9
	FP30050250NSNE	LAMPADA COMPLETA / COMPLETE LAMP	28x26x20	0,4	0,9
<b>SILLABA</b>	F277560150BINE	LAMPADA COMPLETA / COMPLETE LAMP	19x12x18	0,2	0,5
	F277565150BINE	LAMPADA COMPLETA / COMPLETE LAMP	19x12x17,5	0,4	0,6
	F277570150BILE	LAMPADA COMPLETA / COMPLETE LAMP	20,8x13x22,6	0,7	1
	F277570150BINE	LAMPADA COMPLETA / COMPLETE LAMP	21x13x23	0,6	0,9
<b>SILLABONE</b>	F279370150BINE	LAMPADA COMPLETA / COMPLETE LAMP	40x30x41	3,5	4,1
<b>SOLE</b>	F413940150BILE	LAMPADA COMPLETA / COMPLETE LAMP	15x18x60	3,0	3,0
	F414040150BILE	LAMPADA COMPLETA / COMPLETE LAMP	13x6x16	1,0	1,5
<b>THEA</b>	F444965550NFLE	MONTATURA / MOUNTING	16,7x16,7x20	1	1,4
		DIFFUSORE / DIFFUSER	28,7x28,7x24	1,2	1,9
	F444965575RTL	MONTATURA / MOUNTING	16,7x16,7x20	1	1,4
		DIFFUSORE / DIFFUSER	28,7x28,7x24	1,2	1,9
F444970550NFLE	MONTATURA / MOUNTING	22,3x22,3x27	2,6	3,3	
	DIFFUSORE / DIFFUSER	42,5x42,5x33,5	2,6	4,3	
F444970575RTL	MONTATURA / MOUNTING	22,3x22,3x27	2,6	3,3	
	DIFFUSORE / DIFFUSER	42,5x42,5x33,5	2,6	4,3	
<b>TROPICO</b>	F442160550NELE	MONTATURA / MOUNTING	32x32x16	1	1,7
		DIFFUSORE / DIFFUSER	32x32x16	1	1,7
	F442160550OOLE	MONTATURA / MOUNTING	32x32x16	1	1,7
		DIFFUSORE / DIFFUSER	32x32x16	1	1,7
	F442165550NELE	MONTATURA / MOUNTING	44x44x21	2	3,4
		DIFFUSORE / DIFFUSER	44x44x21	2	3,4
	F442165550OOLE	MONTATURA / MOUNTING	44x44x21	2	3,4
DIFFUSORE / DIFFUSER		44x44x21	2	3,4	
F442170550NELE	MONTATURA / MOUNTING	56x56x21	3,7	5,8	
	DIFFUSORE / DIFFUSER	56x56x21	3,7	5,8	
F442170550OOLE	MONTATURA / MOUNTING	56x56x21	3,7	5,8	
		DIFFUSORE / DIFFUSER	56x56x21	3,7	5,8

# LAMPADE A SOSPENSIONE SUSPENSION LAMPS



Famiglia Family	Codice Code	Descrizione Description	Dimensione Size cm A x B x H	Kg netto Kg net	Kg lordo Kg gross
<b>0024</b>	F002485150TRNE	MONTATURA / MOUNTING	36x36x70,5	5	6
		DIFFUSORE / DIFFUSER	62x20x62	17	20
<b>AMAX</b>	F544480350BINE	LAMPADA COMPLETA / COMPLETE LAMP	35x50x35	2,2	3,4
	F544485350BINE	LAMPADA COMPLETA / COMPLETE LAMP	55x50x55	3,7	5,9
	F544490350BINE	LAMPADA COMPLETA / COMPLETE LAMP	85,5x76x85,5	12	22
	F544495350BINE	LAMPADA COMPLETA / COMPLETE LAMP	110x98x110	17,5	33,5
<b>AVICO</b>	F556180350BINE	LAMPADA COMPLETA / COMPLETE LAMP	125,5x66,5x125,5	20	30
	F556180375NENE	LAMPADA COMPLETA / COMPLETE LAMP	125,5x66,5x125,5	20	30
	F556185350BINE	LAMPADA COMPLETA / COMPLETE LAMP	165x96x165	30	45
	F556185375NENE	LAMPADA COMPLETA / COMPLETE LAMP	165x96x165	30	45
<b>BIANCA</b>	F430685150BILE	MONTATURA / MOUNTING	20x15x20	1	1,2
		DIFFUSORE / DIFFUSER	40x27,5x40	1,8	2,1
	F430680150BILE	LAMPADA COMPLETA / COMPLETE LAMP	21x16x21	1	1,2
	F430690150BINE	LAMPADA COMPLETA / COMPLETE LAMP	61x57x61	6	8,5
<b>BOLLA</b>	F354085100TRNE	MONTATURA / MOUNTING	22x15x20	0,7	1,5
		DIFFUSORE / DIFFUSER	40x40x40	3	4
	F354090100TRNE	MONTATURA / MOUNTING	22x15x20	0,7	1,5
		DIFFUSORE / DIFFUSER	65x40x40	3,5	4,5
<b>CHANDELIER</b>	F549180250NBNE	LAMPADA COMPLETA / COMPLETE LAMP	90x20x90	13	14,5
	F549180260OBNE	LAMPADA COMPLETA / COMPLETE LAMP	90x20x90	13	14,5
	F549185250NBNE	LAMPADA COMPLETA / COMPLETE LAMP	170x20x170	18	25
	F549185260OBNE	LAMPADA COMPLETA / COMPLETE LAMP	170x20x170	18	25
	F549190250NBNE	LAMPADA COMPLETA / COMPLETE LAMP	100x20x100	19	21
	F549190260OBNE	LAMPADA COMPLETA / COMPLETE LAMP	100x20x100	19	21
	F549195250NBNE	LAMPADA COMPLETA / COMPLETE LAMP	157x20x157	31	35
	F549195260OBNE	LAMPADA COMPLETA / COMPLETE LAMP	157x20x157	31	35
<b>CHESHIRE</b>	F425785350BINE	LAMPADA COMPLETA / COMPLETE LAMP	44x51,5x44,5	2,35	4,1
	F425785350NENE	LAMPADA COMPLETA / COMPLETE LAMP	44x51,5x44	2,35	4,1
<b>EQUATORE</b>	F439080150OOLE	MONTATURA / MOUNTING	32x56x32	5,4	6,4
		DIFFUSORE / DIFFUSER	32x22,5x32	1,7	2,5
	F439080550CRLE	MONTATURA / MOUNTING	32x56x32	5,4	6,4
		DIFFUSORE / DIFFUSER	32x22,5x32	1,7	2,5
	F439080550NELE	MONTATURA / MOUNTING	32x56x32	5,4	6,4
		DIFFUSORE / DIFFUSER	32x22,5x32	1,7	2,5
	F439080550RSLE	MONTATURA / MOUNTING	32x56x32	5,4	6,4
		DIFFUSORE / DIFFUSER	32x22,5x32	1,7	2,5
	F439085150OOLE	MONTATURA / MOUNTING	43x76x43	7,4	10
		DIFFUSORE / DIFFUSER	43x33,5x43	3,4	5,3
F439085550CRLE	MONTATURA / MOUNTING	43x76x43	7,4	10	
	DIFFUSORE / DIFFUSER	43x33,5x43	3,4	5,3	
F439085550NELE	MONTATURA / MOUNTING	43x76x43	7,4	10	
	DIFFUSORE / DIFFUSER	43x33,5x43	3,4	5,3	
F439085550RSLE	MONTATURA / MOUNTING	43x76x43	7,4	10	
	DIFFUSORE / DIFFUSER	43x33,5x43	3,4	5,3	
F439090150OOLE	MONTATURA / MOUNTING	61x90x61	12,5	18,8	
	DIFFUSORE / DIFFUSER	32x22,5x32	1,7	2,5	



Famiglia Family	Codice Code	Descrizione Description	Dimensione Size cm A x B x H	Kg netto Kg net	Kg lordo Kg gross
	F439090550CRLE	MONTATURA / MOUNTING DIFFUSORE / DIFFUSER	61x90x61 61x47x61	12,5 4,5	18,8 7,6
	F439090550NELE	MONTATURA / MOUNTING DIFFUSORE / DIFFUSER	61x90x61 61x47x61	12,5 4,5	18,8 7,6
	F439090550RSLE	MONTATURA / MOUNTING DIFFUSORE / DIFFUSER	61x90x61 61x47x61	12,5 4,5	18,8 7,6
<b>FONTANELLA</b>	F447890550CRNE	MONTATURA / MOUNTING DIFFUSORE / DIFFUSER	25,3x15,8x16,2 48,5x48,5x27,5	0,9 0,5	1,2 1
	F447890550NENE	MONTATURA / MOUNTING DIFFUSORE / DIFFUSER	25,3x15,8x16,2 48,5x48,5x27,5	0,9 0,5	1,2 1
	F447890550OTNE	MONTATURA / MOUNTING DIFFUSORE / DIFFUSER	25,3x15,8x16,2 48,5x48,5x27,5	0,9 0,5	1,2 1
	F447885550CRNE	MONTATURA / MOUNTING DIFFUSORE / DIFFUSER	25,3x15,8x16,2 32,5x32,5x37,5	0,9 0,5	1,2 1
	F447885550NENE	MONTATURA / MOUNTING DIFFUSORE / DIFFUSER	25,3x15,8x16,2 32,5x32,5x27,5	0,9 0,5	1,2 1
	F447885550OTNE	MONTATURA / MOUNTING DIFFUSORE / DIFFUSER	25,3x15,8x16,2 32,5x32,5x27,5	0,9 0,5	1,2 1
<b>FLÛTE</b>	F333780150TCNE	LAMPADA COMPLETA / COMPLETE LAMP	45x28x27	1	1,7
	F333780550NENE	LAMPADA COMPLETA / COMPLETE LAMP	45x28x27	1	1,7
	F333780550RMNE	LAMPADA COMPLETA / COMPLETE LAMP	45x28x27	1	1,7
	F333785550TCNE	LAMPADA COMPLETA / COMPLETE LAMP	85x28x27	2,2	3,6
	F333790550TCNE	LAMPADA COMPLETA / COMPLETE LAMP	135x26x25	3,5	5
<b>GLOBO DI LUCE</b>	F364480150CRNE	LAMPADA COMPLETA / COMPLETE LAMP	26,5x23,5x26,5	1,3	1,9
	F364480150RMNE	LAMPADA COMPLETA / COMPLETE LAMP	26,5x23,5x26,5	1,3	1,9
	F364485150CRNE	LAMPADA COMPLETA / COMPLETE LAMP	40x40x40	2	3,1
	F364485150RMNE	LAMPADA COMPLETA / COMPLETE LAMP	40x40x40	2	3,1
	F364490150CRNE	LAMPADA COMPLETA / COMPLETE LAMP	60x60x60	5	7
	F364490150RMNE	LAMPADA COMPLETA / COMPLETE LAMP	60x60x60	5	7
<b>HUNA</b>	F505985200ALNE	LAMPADA COMPLETA / COMPLETE LAMP	53x38x53	1,7	2,5
	F505985200NENE	LAMPADA COMPLETA / COMPLETE LAMP	53x38x53	1,7	2,5
<b>LAMPARA</b>	F500090200ALNE	LAMPADA COMPLETA / COMPLETE LAMP	47x60x47	2	2,8
	F500090220BINE	LAMPADA COMPLETA / COMPLETE LAMP	47x60x47	2	2,8
<b>MERIDIANO</b>	F441785550NFLE	MONTATURA / MOUNTING DIFFUSORE / DIFFUSER	23x23x54,5 39x39x49	3 2,8	4 4,8
	F441785550NRLE	MONTATURA / MOUNTING DIFFUSORE / DIFFUSER	23x23x54,5 39x39x49	3 2,8	4 4,8
	F441785550NTLE	MONTATURA / MOUNTING DIFFUSORE / DIFFUSER	23x23x54,5 39x39x49	3 2,8	4 4,8
	F441790550NFLE	MONTATURA / MOUNTING DIFFUSORE / DIFFUSER	23x23x68 48,5x48,5x63	4,1 6	5,4 9
	F441790550NRLE	MONTATURA / MOUNTING DIFFUSORE / DIFFUSER	23x23x68 48,5x48,5x63	4,1 6	5,4 9
	F441790550NTLE	MONTATURA / MOUNTING DIFFUSORE / DIFFUSER	23x23x68 48,5x48,5x63	4,1 6	5,4 9
<b>OORT</b>	OORT00003	MONTATURA / MOUNTING DIFFUSORE / DIFFUSER	23x21x10,5 149,5x16,5x10	0,7 1,7	0,9 2,7
	OORT00012	MONTATURA / MOUNTING DIFFUSORE / DIFFUSER	23x21x10,5 149,5x16,5x10	0,7 1,7	0,9 2,7
	OORT00004	MONTATURA / MOUNTING DIFFUSORE / DIFFUSER	28x30x11,5 179,5x16,5x10	1,6 2	2 3,5

Famiglia Family	Codice Code	Descrizione Description	Dimensione Size cm A x B x H	Kg netto Kg net	Kg lordo Kg gross
	OORT00013	MONTATURA / MOUNTING DIFFUSORE / DIFFUSER	28x30x11,5 179,5x16,5x10	1,6 2	2 3,5
	OORT00005	MONTATURA / MOUNTING DIFFUSORE / DIFFUSER	28x30x11,5 70,5x16,5x10	1,6 1	2 1,4
	OORT00014	MONTATURA / MOUNTING DIFFUSORE / DIFFUSER	28x30x11,5 70,5x16,5x10	1,6 1	2 1,4
	OORT00006	MONTATURA / MOUNTING DIFFUSORE / DIFFUSER	28x30x11,5 149,5x16,5x10	1,6 1,5	2 2,5
	OORT00015	MONTATURA / MOUNTING DIFFUSORE / DIFFUSER	28x30x11,5 149,5x16,5x10	1,6 1,5	2 2,5
	OORT00007	MONTATURA / MOUNTING DIFFUSORE / DIFFUSER	28x30x11,5 179,5x16,5x10	1,6 2	2 3,5
	OORT00016	MONTATURA / MOUNTING DIFFUSORE / DIFFUSER	28x30x11,5 179,5x16,5x10	1,6 2	2 3,5
	OORT00008	MONTATURA / MOUNTING DIFFUSORE / DIFFUSER	28x30x11,5 70,5x16,5x10	1,6 1	2 1,4
	OORT00017	MONTATURA / MOUNTING DIFFUSORE / DIFFUSER	28x30x11,5 70,5x16,5x10	1,6 1	2 1,4
	OORT00009	MONTATURA / MOUNTING DIFFUSORE / DIFFUSER DIFFUSORE / DIFFUSER DIFFUSORE / DIFFUSER	28x30x11,5 70,5x16,5x10 149,5x16,5x10 179,5x16,5x10	1,6 1 1,5 2	2 1,4 2,5 3,5
	OORT00018	MONTATURA / MOUNTING DIFFUSORE / DIFFUSER DIFFUSORE / DIFFUSER DIFFUSORE / DIFFUSER	28x30x11,5 70,5x16,5x10 149,5x16,5x10 179,5x16,5x10	1,6 1 1,5 2	2 1,4 2,5 3,5
<b>PALLINA</b>	F443080150ORNE	LAMPADA COMPLETA / COMPLETE LAMP	19x19x42	1,5	2
	F443080150NENE	LAMPADA COMPLETA / COMPLETE LAMP	19x19x42	1,5	2
	F443080150NSNE	LAMPADA COMPLETA / COMPLETE LAMP	19x19x42	1,5	2
	F443080150OTNE	LAMPADA COMPLETA / COMPLETE LAMP	19x19x42	1,5	2
<b>PANGEN</b>	F419685350BINE	LAMPADA COMPLETA / COMPLETE LAMP	67x30x67	3,5	4,5
	F419685350NENE	LAMPADA COMPLETA / COMPLETE LAMP	67x30x67	3,5	4,5
	F419685350RONE	LAMPADA COMPLETA / COMPLETE LAMP	67x30x67	3,5	4,5
<b>PAROLA</b>	F428485100AMNE	MONTATURA / MOUNTING DIFFUSORE / DIFFUSER	13,5x12,5x13,5 41x36x41	0,3 2	0,4 3
	F428485100BINE	MONTATURA / MOUNTING DIFFUSORE / DIFFUSER	13,5x12,5x13,5 41x36x41	0,3 2	0,4 3
<b>PINECONE</b>	F433990550CBNE	LAMPADA COMPLETA / COMPLETE LAMP	64x58x64	11	14
	F433990550TCNE	LAMPADA COMPLETA / COMPLETE LAMP	64x58x64	11	14
	F433990575OBNE	LAMPADA COMPLETA / COMPLETE LAMP	65x58x65	11	14
	F433990575TONE	LAMPADA COMPLETA / COMPLETE LAMP	64x58x64	11	14
	F436385550CBNE	LAMPADA COMPLETA / COMPLETE LAMP	40x40x40	5,5	6,5
	F436385550TCNE	LAMPADA COMPLETA / COMPLETE LAMP	40x40x40	5,5	6,5
	F436385575OBNE	LAMPADA COMPLETA / COMPLETE LAMP	40x40x40	5,5	6,5
	F436385575TONE	LAMPADA COMPLETA / COMPLETE LAMP	40x40x40	5,5	6,5
	F446690550TCLE	LAMPADA COMPLETA / COMPLETE LAMP	38,5x37x90	6,3	8,5
	F446690575TOLE	LAMPADA COMPLETA / COMPLETE LAMP	38,5x37x90	6,3	8,5
<b>SCINTILLA</b>	FS15085250CRNE	LAMPADA COMPLETA / COMPLETE LAMP	36x15x26	0,5	1
	FS15085250NSNE	LAMPADA COMPLETA / COMPLETE LAMP	36x15x26	0,5	1
	FS30090250CRNE	LAMPADA COMPLETA / COMPLETE LAMP	36x15x26	0,6	1
	FS30090250NSNE	LAMPADA COMPLETA / COMPLETE LAMP	14x36x26	0,5	0,9

Famiglia Family	Codice Code	Descrizione Description	Dimensione Size cm A x B x H	Kg netto Kg net	Kg lordo Kg gross
<b>SERPENTINE</b>	F417585350BLE	LAMPADA COMPLETA / COMPLETE LAMP	14x14x130	2,5	3,0
<b>SETAREH</b>	F438G80550NBLE	MONTATURA / MOUNTING DIFFUSORE / DIFFUSER	25x80,5x25 50,5x8,5x50,5	2 0,9	3,5 2
	F438G80550OBLE	MONTATURA / MOUNTING DIFFUSORE / DIFFUSER	25x80,5x25 25x80,5x25	2 2	3,5 3,5
	F438G85550NBLE	MONTATURA / MOUNTING DIFFUSORE / DIFFUSER	25x80,5x25 70,5x8,5x70,5	2 2,2	3,5 4,5
	F438G85550OBLE	MONTATURA / MOUNTING DIFFUSORE / DIFFUSER	25x80,5x25 70,5x8,5x70,5	2 2,2	3,5 4,5
	F438G90550NBLE	MONTATURA / MOUNTING DIFFUSORE / DIFFUSER	30x94x30,5 90,5x8,5x90,5	3 5,5	4,5 7,5
	F438G90550OBLE	MONTATURA / MOUNTING DIFFUSORE / DIFFUSER	30x94x30,5 90,5x8,5x90,5	3 5,5	4,5 7,5
	F438M85550NBLE	MONTATURA / MOUNTING DIFFUSORE / DIFFUSER	25x80,5x25 70x1x70	2 1,6	3,5 2,5
	F438M85550OBLE	MONTATURA / MOUNTING DIFFUSORE / DIFFUSER	25x80,5x25 70x1x70	2 1,6	3,5 2,5
	F438M90550NBLE	MONTATURA / MOUNTING DIFFUSORE / DIFFUSER	30,5x94x30,5 90x1x90	3 3	4,5 5
	F438M90550OBLE	MONTATURA / MOUNTING DIFFUSORE / DIFFUSER	30,5x94x30,5 90x1x90	3 3	4,5 5
	F440485550NBLE	MONTATURA / MOUNTING DIFFUSORE / DIFFUSER	25x100,5x25 19x18,5x20	1,7 0,4	1,7 0,7
	F440485550OBLE	MONTATURA / MOUNTING DIFFUSORE / DIFFUSER	25x100,5x25 19x18,5x20	1,7 0,4	1,7 0,7
	F440590550NBLE	MONTATURA / MOUNTING DIFFUSORE / DIFFUSER	25x113,5x25 19x18,5x20	2 0,4	2 0,7
	F440590550OBLE	MONTATURA / MOUNTING DIFFUSORE / DIFFUSER	25x113,5x25 19x18,5x20	2 0,4	2 0,7
	F438080550NBLE	LAMPADA COMPLETA / COMPLETE LAMP	25x80,5x25	2	3,5
	F438080550OBLE	LAMPADA COMPLETA / COMPLETE LAMP	25x80,5x25	2	3,5
	F438380550NBLE	LAMPADA COMPLETA / COMPLETE LAMP	50,5x48x50,5	3	4,5
	F438380550OBLE	LAMPADA COMPLETA / COMPLETE LAMP	50,5x48x50,5	3	4,5
<b>THEA</b>	F444985550NFLE	MONTATURA / MOUNTING DIFFUSORE / DIFFUSER	20x20x46 28,7x28,7x24	1,9 1,2	2,5 1,9
	F444985575RTLE	MONTATURA / MOUNTING DIFFUSORE / DIFFUSER	20x20x46 28,7x28,7x24	1,9 1,2	2,5 1,9
	F444990550NFLE	MONTATURA / MOUNTING DIFFUSORE / DIFFUSER	20x20x68 42,5x42,5x33,5	3 2,6	4 4,3
	F444990575RTLE	MONTATURA / MOUNTING DIFFUSORE / DIFFUSER	20x20x68 42,5x42,5x33,5	3 2,6	4 4,3
<b>TUTTI</b>	F446880240..LE	LAMPADA COMPLETA / COMPLETE LAMP	25x80,5x25	2	3,5
	F446980240..LE	MONTATURA / MOUNTING CORPO / BODY	28x30x11,5 23,5x18,5x29,5	1 0,5	1,4 0,8
	F447080240..LE	MONTATURA / MOUNTING CORPO / BODY	28x30x11,5 23,5x18,5x29,5	1 0,5	1,4 0,8
	F447180240..LE	MONTATURA / MOUNTING CORPO / BODY	28x30x11,5 23,5x18,5x29,5	1 0,5	1,4 0,8
	F447380240..LE	MONTATURA / MOUNTING CORPO / BODY	28x30x11,5 23,5x18,5x29,5	1 0,5	1,4 0,8
	F447280240..LE	MONTATURA / MOUNTING CORPO / BODY	28x30x11,5 23,5x18,5x29,5	1 0,5	1,4 0,8
	F447480240..LE	MONTATURA / MOUNTING CORPO / BODY	28x30x11,5 23,5x18,5x29,5	1 0,5	1,4 0,8

Famiglia Family	Codice Code	Descrizione Description	Dimensione Size cm A x B x H	Kg netto Kg net	Kg lordo Kg gross
	F447580240..LE	MONTATURA / MOUNTING CORPO / BODY	28x30x11,5 23,5x18,5x29,5	1 0,5	1,4 0,8
	F446890240LE	MONTATURA / MOUNTING CORPO / BODY CORPO / BODY CORPO / BODY CORPO / BODY CORPO / BODY CORPO / BODY CORPO / BODY CORPO / BODY CORPO / BODY	63x62x10 23,5x18,5x29,5 23,5x18,5x29,5 23,5x18,5x29,5 23,5x18,5x29,5 23,5x18,5x29,5 23,5x18,5x29,5 23,5x18,5x29,5 23,5x18,5x29,5 23,5x18,5x29,5	4,3 0,5 0,5 0,5 0,5 0,5 0,5 0,5 0,5 0,5	6,4 0,8 0,8 0,8 0,8 0,8 0,8 0,8 0,8 0,8

## OUTDOOR



Famiglia Family	Codice Code	Descrizione Description	Dimensione Size cm A x B x H	Kg netto Kg net	Kg lordo Kg gross
<b>NASKA</b>	F810528200BINE	LAMPADA COMPLETA / COMPLETE LAMP	165x70x70	63	65
	F810528200NENE	LAMPADA COMPLETA / COMPLETE LAMP	165x70x70	63	65
<b>OORT</b>	OORT05001	LAMPADA COMPLETA / COMPLETE LAMP	21x21x38	0,7	1,2
	OORT05011	LAMPADA COMPLETA / COMPLETE LAMP	21x21x38	0,7	1,2
	OORT05003	LAMPADA COMPLETA / COMPLETE LAMP	21x21x48	0,8	1,4
	OORT05013	LAMPADA COMPLETA / COMPLETE LAMP	21x21x48	0,8	1,4
	OORT05005	LAMPADA COMPLETA / COMPLETE LAMP	21x21x58	0,9	1,6
	OORT05015	LAMPADA COMPLETA / COMPLETE LAMP	21x21x58	0,9	1,6
	OORT05031	LAMPADA COMPLETA / COMPLETE LAMP	45x41x41	2,6	3,7
	OORT05041	LAMPADA COMPLETA / COMPLETE LAMP	45x41x41	2,6	3,7
	OORT05033	LAMPADA COMPLETA / COMPLETE LAMP	55x41x41	2,8	4,2
	OORT05043	LAMPADA COMPLETA / COMPLETE LAMP	55x41x41	2,8	4,2
	OORT05035	LAMPADA COMPLETA / COMPLETE LAMP	65x41x41	3	4,7
	OORT05045	LAMPADA COMPLETA / COMPLETE LAMP	65x41x41	3	4,7
<b>UOVO RIC. / REC.</b>	F264600150BIBW	MONTATURA / MOUNTING DIFFUSORE / DIFFUSER	15x10x15 24x40x24	0,2 1	0,3 1,5
<b>UOVO</b>	F264613370BINE	MONTATURA / MOUNTING DIFFUSORE / DIFFUSER	20x15x20 55x55x85	0,4 4,2	0,6 6













































# ARREDO E VASI FURNITURE AND VASES









































Famiglia Family	Codice Code	Descrizione Description	Dimensione Size cm A x B x H	Kg netto Kg net	Kg lordo Kg gross
<b>CARTOCCIO</b>	F2910VA100OP10		39x30x39	4,5	5,5
	F2920VA100TR20		39,5x36,5x39,5	4,5	5,5
	F3010VA100TR10		39,5x36,5x39,5	4,5	5,5
<b>FONTANA</b>	F2600TB100TR00		70x50x50	21	40
	F2610TB100TR10		130x50x70	36	60
	F2620TB100TR20		150x50x80	57	90
<b>TAVOLINO 1932</b>	F2710TB150TR10	PIANO / TOP	72x15x72	10	12
		STRUTTURA / STRUCTURE	73x18x73	18	20
<b>TAVOLO CON RUOTE</b>	F1000TB150TR00	PIANO / TOP	80x10x150	24	34
		RUOTE / WHEELS	35x20x50	12	13
	F1010TB150TR10	PIANO / TOP	160x10x110	52	62
		RUOTE / WHEELS	35x20x50	12	13
	F1110TB150TR00	PIANO / TOP	110x10x110	34,5	44,5
		RUOTE / WHEELS	35x20x50	12	13
F1120TB150TR20	PIANO / TOP	120x10x120	42	52	
	RUOTE / WHEELS	35x20x50	12	13	
<b>TESO (TAVOLO / TABLE)</b>	F2720TA150TR20	PIANO / TOP	95x10x230	100	120
		RUOTE / WHEELS	85x30x100	35	45
<b>TESO (LIBRERIA / BOOKCASE)</b>	F2720LI150TR20	STRUTTURA / STRUCTURE	50x7x60	5	6
		MENSOLE / SHELVES	45x20x250	85	100
		MONTANTI / UPRIGHTS	45x50x45	30	35
<b>TOUR</b>	F3010TA150TR10	STRUTTURA / STRUCTURE	23x8x50	4	5
		MENSOLE / SHELVES	45x12x250	65	80
		MONTANTI / UPRIGHTS	35x20x45	10	15
<b>TOUR</b>	F3010TA150TR10	PIANO / TOP	125x5x125	57	58
		RUOTE / WHEELS	55x50x55	15	16

# TABELLA SORGENTI LUMINOSE / TABLE FOR LIGHTING SOURCE

## LAMPADE DA TAVOLO TABLE LAMPS



































Famiglia Family	Codice prodotto Product code	Lampadine consigliate Recommended light source	Etichetta energetica Energy Label
<b>3247</b>	F324700150KBNE	 LED 1x10,5W E27 (2700K, 1055Lm) or  HA 1x57W E27 (2800K, 915Lm)	A → G
	F324710150KBNE	 LED 1x14W E27 (2700K, 1521Lm) or  HA 1x100W E27 (2900K, 1800Lm)	A → G
<b>ASHANGHAI</b>	F418805150CBNE	 LED 3x6W E14 (2700K, 3x470Lm) or  HA 3x30W E14 (2700K, 3x405Lm)	A → G
<b>BIANCA</b>	F430810150BINE	 LED 1x21W E27 (2700K, 2452Lm) or  HA 1x116W E27 (2800K, 2135Lm)	A → G
<b>BILIA MINI</b>	F247400.....NE	 LED 1x6W G9 (2700K, 470Lm)	A → G
<b>BILIA</b>	F247405.....NE	 LED 1x6W E14 (2700K, 470Lm) or  HA 1x46W E14 (2700K, 700Lm)	A → G
<b>BIS/TRIS</b>	F228005150..NE	 LED 4x5,7W E14 (2700K, 4x470Lm) or  HA 4x30W E14 (2700K, 4x405Lm)	A → G
<b>BLOM</b>	F425305350..NE	 LED 1x5,7W E14 (2700K, 470Lm)	A → G
<b>CHESHIRE</b>	F425105350..NE	 LED 3x14W E27 (2700K, 3x1521Lm)	A → G
<b>DARUMA</b>	F502800100BINE	 LED 1x3,3W E27 (2700K, 250Lm) or  HA 1x20W E27 (2700K, 235Lm)	A → G
	F502805100BINE	 LED 1x8,5W E27 (2700K, 806Lm) or  HA 1x46W E27 (2700K, 700Lm)	A → G
	F502810100BINE	 LED 1x14W E27 (2700K, 1521Lm) or  HA 1x100W E27 (2900K, 1800Lm)	A → G
<b>FALENA</b>	F301705150CRNE	 HA 1x50W GY6.35 (3000K, 900Lm)	A → G
<b>FONTANA</b>	F185300100BINE	 LED 1x21W E27 (2700K, 2500Lm)  + LED 2x4W G9 (2700K, 2x400Lm) or  HA 1x46W E27 (2700K, 700Lm)  + HA 2x20W G9 (2700K, 2x235Lm)	A → G
	F185300200OTNE	 LED 1x21W E27 (2700K, 2500Lm) or  HA 1x100W E27 (2900K, 1800Lm)	A → G
	F185305100BINE	 LED 1x21W E27 (2700K, 2500Lm)  + LED 2x4,5W E14 (2700K, 2x470Lm) or  HA 1x100W E27 (2900K, 1800Lm)  + HA 2x30W E14 (2700K, 2x405Lm)	A → G
	F185305200OTNE	 LED 1x21W E27 (2700K, 2500Lm) or  HA 1x100W E27 (2900K, 1800Lm)	A → G
	F185310100BINE	 LED 1x21W E27 (2700K, 2500Lm)  + LED 4x4W E27 (2700K, 4x400Lm)  + LED 2x4,5W E14 (2700K, 2x470Lm) or  HA 1x100W E27 (2900K, 1800Lm)  + HA 4x46W E27 (2700K, 4x700Lm)  + HA 2x30W E14 (2700K, 2x405Lm)	A → G
<b>FONTANELLA</b>	F442305550..NE	 LED 1x6W E14 or  HA 1x28W E14	A → G
	F442310550..NE	 LED 1x12W E27 or  HA 1x77W E27	A → G

Questa tabella raccoglie le informazioni necessarie per l'acquisto corretto della fonte luminosa (esclusi i modelli con LED integrati).  
La classe energetica del prodotto dipende dalla sorgente luminosa utilizzata.

Famiglia Family	Codice prodotto Product code	Lampadine consigliate Recommended light source	Etichetta energetica Energy Label
<b>GIOVA</b>	F268405150..NE	 LED 1x8,5W E27 (2700K, 806Lm) or  HA 1x46W E27 (2700K, 700Lm)	A → G
	F268410150..NE	 LED 1x14W E27 (2700K, 1521Lm) or  HA 1x100W E27 (2900K, 1800Lm)	A → G
<b>MANO</b>	F420805400NENE	 LED 1x10,5W E27 (2700K, 1055Lm) or  HA 1x57W E27 (2800K, 915Lm)	A → G
<b>METAFORA</b>	F265405150BTNE	 LED 1x21W E27 (2700K, 2452Lm) or  HA 1x116W E27 (2800K, 2135Lm)	A → G
<b>NASKA</b>	F810010.....NE	 LED 1x9,5W E27 (2700K, 806Lm) or  HA 1x46W E27 (2700K, 700Lm)	A → G
	F810110.....NE	 LED 1x9,5W E27 (2700K, 806Lm) or  HA 1x46W E27 (2700K, 700Lm)	A → G
	F810700.....NE	 LED 1x5,7W E27 (2700K, 470Lm) or  HA 1x30W E27 (2700K, 405Lm)	A → G
<b>PALLINA</b>	F443000150..NE	 LED 1x6W G9 (2700K, 470Lm)	A → G
<b>PAROLA</b>	F265805100..NE	 LED 1x6W E14 (2700K, 470Lm) or  HA 1x46W E14 (2700K, 700Lm)	A → G
<b>PASSION</b>	F361000150..NE	 LED 1x3,5W G9 (2700K, 350Lm) or  HA 1x48W G9 (2800K, 740Lm)	A → G
	F361005150..NE	 LED 1x3,5W G9 (2700K, 350Lm) or  HA 1x48W G9 (2800K, 740Lm)	A → G
<b>PINECONE</b>	F436405.....NE	 LED 1x21W E27 (2700K, 2452Lm) or  HA 1x116W E27 (2800K, 2135Lm)	A → G
	F434010.....NE	 LED 1x21W E27 (2700K, 2452Lm) or  HA 1x116W E27 (2800K, 2135Lm)	A → G
<b>PIRELLINA</b>	F278205150KBNE	 LED 4x2,5W E14 (2700K, 250Lm) or  HA 4x20W E14 (2700K, 235Lm)	A → G
<b>THOR</b>	F329500100BINE	 LED 1x5,7W E14 (2700K, 470Lm) or  HA 1x30W E14 (2700K, 405Lm)	A → G
	F329505100BINE	 LED 1x9,5W E27 (2700K, 806Lm) or  HA 1x46W E27(2700K, 700Lm)	A → G
<b>UOVO</b>	F264600100BINE	 LED 1x5,5W E27 (2700K, 470Lm) or  HA 1x30W E27(2700K, 405Lm)	A → G
	F264605100BINE	 LED 1x10,5W E27 (2700K, 1055Lm) or  HA 1x70W E27(2800K, 1180Lm)	A → G
	F264610100BINE	 LED 1x14W E27 (2700K, 1521Lm) or  HA 1x100W E27 (2900K, 1800Lm)	A → G
	F264613370BINE	 LED 1x30W E27	A → G

This table collects the necessary information for the correct purchase of the light source (excluding models with integrated LEDs).  
The energy class of the product depends on the light source used.





























## LAMPADE DA TERRA FLOOR LAMPS

Famiglia Family	Codice prodotto Product code	Lampadine consigliate Recommended light source	Etichetta energetica Energy Label
<b>0024</b>	F002430150TRNE	 LED 1x21W E27 (2700K, 2452Lm) or  HA 1x205W E27 (3000K, 4200Lm)	A → G
<b>3247</b>	F324725150KBNE	 LED 1x21W E27 (2700K, 2452Lm) or  HA 1x150W E27 (2900K, 2870Lm)	A → G
	F324730150KBNE	 LED 4x9W E27 (2700K, 4x806Lm)  + LED 1x14W E27 (2700K, 1521Lm) or  HA 4x46W E27 (2700K, 4x600Lm)  + HA 1x100W E27 (2900K, 1800Lm)	A → G
<b>BIANCA</b>	F430930150BINE	 LED 1x21W E27 (2700K, 2452Lm) or  HA 1x116W E27 (2800K, 2135Lm)	A → G
<b>CHESHIRE</b>	F425225350..NE	 LED 3x14W E27 (2700K, 3x1521Lm)	A → G
<b>FALENA</b>	F301825150CRNE	 HA 1x50W GY6.35 (3000K, 900Lm)	A → G
<b>FLÛTE</b>	F330025150TCNE	 LED 1x21W E27 (2700K, 2452Lm) or  HA 1x205W E27 (3000K, 4200Lm)	A → G
	F330030150TCNE	 HA 1x230W R7s/115 (3000K, 8750Lm)	A → G
<b>LUMEN</b>	F248225150BINE	 LED 4x9W E27 (2700K, 4x806Lm)  + LED 1x14W E27 (2700K, 1521Lm) or  HA 4x46W E27 (2700K, 4x700Lm)  + HA 1x100W E27 (2900K, 1800Lm)	A → G
<b>PAROLA</b>	F265925100..NE	 LED 1x12W E14 (2700K, 470Lm) or  HA 1x46W E14 (2700K, 700Lm)	A → G
<b>PAROLONA</b>	F275130150BINE	 LED 1x12W E14 (2700K, 470Lm) or  HA 1x46W E14 (2700K, 700Lm)	A → G
<b>PASSION</b>	F361125150CRNE	 LED 2x14W E27 (2700K, 2x1521Lm) or  HA 2x100W E27 (2900K, 2x1800Lm)	A → G
<b>PIRELLONE</b>	F275930150KBNE	 LED 10x3,5W G9 (2700K, 10x350Lm)  + HA 1x230W R7s/115 or  HA 10x33W G9 (2700K, 10x460Lm)  + HA 1x230W R7s/115	A → G
<b>PRIMA SIGNORA</b>	F289130150CBNE	 LED 1x21W E27 (2700K, 2452Lm) or  HA 1x205W E27 (3000K, 4200Lm)	A → G
<b>SCINTILLA</b>	F272930250..NE	 HA 1x230W R7s/115 (2900K, 5000Lm)	A → G
<b>TRIPOD</b>	F439825150NENE	 HA 1x105W E27  + LED 2x7W GU10	A → G

















































Questa tabella raccoglie le informazioni necessarie per l'acquisto corretto della fonte luminosa (esclusi i modelli con LED integrati).  
La classe energetica del prodotto dipende dalla sorgente luminosa utilizzata.









## LAMPADE A PARETE E A PLAFONE WALL AND CEILING LAMPS

Famiglia Family	Codice prodotto Product code	Lampadine consigliate Recommended light source	Etichetta energetica Energy Label
<b>BIANCA</b>	F432870150BINE	 LED 1x21W E27 (2700K, 2452Lm) or  HA 1x116W E27 (2800K, 2135Lm)	A → G
<b>BRUCO</b>	F353845100BINE	 LED 1x6W E14 (2700K, 470Lm) or  HA 1x46W E14 (2700K, 700Lm)	A → G
<b>FALENA</b>	F301945150CRNE	 HA 1x50W GY6.35 (3000K, 900Lm)	A → G
<b>FONTANELLA</b>	F442305550..NE	 LED 1x6W E14 or  HA 1x28W E14	A → G
	F442310550..NE	 LED 1x12W E27 or  HA 1x77W E27	A → G
<b>NASKA</b>	F447745.....NE	 LED 1x9,5W E27 (2700K, 806Lm) or  HA 1x46W E27 (2700K, 700Lm)	A → G
	F447750.....NE	 LED 1x5,7W E27 (2700K, 470Lm) or  HA 1x30W E27 (2700K, 405Lm)	A → G
<b>PALLINA</b>	F443060150..NE	 LED 1x6W G9 (2700K, 470Lm)	A → G
<b>PANGEN</b>	F419766350..NE	 LED 3x9W E27 (2700K, 900Lm) or  HA 3x46W E27 (2700K, 2100Lm)	A → G
<b>PAROLA</b>	F268945150..NE	 LED 1x6W E14 (2700K, 470Lm) or  HA 1x46W E14 (2700K, 700Lm)	A → G
<b>SCINTILLA</b>	FP15045250..NE	 HA 1x120W R7s/80 (2900K, 2250Lm)	A → G
	FP30050250..NE	 HA 1x230W R7s/115 (2900K, 5000Lm)	A → G
<b>SILLABA</b>	F277560150BINE	 LED 1x2,4W G4 (2700K, 300Lm) or  HA 1x20W G4 (2800K, 320Lm)	A → G
	F277565150BINE	 LED 1x2,4W GY6.35 (2700K, 300Lm) or  HA 1x50W GY6.35 (3000K, 900Lm)	A → G
	F277570150BINE	 LED 1x3,8W G9 (2700K, 470Lm) or  HA 1x60W G9 (2800K, 980Lm)	A → G
<b>SILLABONE</b>	F279370150BINE	 LED 1x14W E27 (2700K, 1521Lm) or  HA 1x100W E27 (2800K, 1800Lm)	A → G

## LAMPADE A SOSPENSIONE SUSPENSION LAMPS

Famiglia Family	Codice prodotto Product code	Lampadine consigliate Recommended light source	Etichetta energetica Energy Label
<b>0024</b>	F002485150TRNE	 FL 2x36W 2G11	A → G
	F002490150TRNE	 FL 4x54W G5	A → G
<b>AMAX</b>	F544480350BINE	 LED 1x14W E27 (2700K, 1521Lm) or  HA 1x100W E27 (2900K, 1800Lm)	A → G
	F544485350BINE	 LED 1x21W E27 (2700K, 2452Lm) or  HA 1x150W E27 (2900K, 2870Lm)	A → G
	F544490350BINE	 LED 3x14W E27 (2700K, 1521Lm) or  HA 3x100W E27 (2900K, 1800Lm)	A → G
	F544495350BINE	 LED 3x21W E27 (2700K, 2452Lm) or  HA 3x150W E27 (2900K, 2870Lm)	A → G
<b>AVICO</b>	F556180350..NE	 LED 3x14W E27 (2700K, 1521Lm) or  HA 3x100W E27 (2900K, 1800Lm)	A → G
	F556185350..NE	 LED 3x21W E27 (2700K, 2452Lm) or  HA 3x150W E27 (2900K, 2870Lm)	A → G
<b>BIANCA</b>	F430690150BINE	 LED 1x21W E27 (2700K, 2452Lm) or  HA 1x116W E27 (2800K, 2135Lm)	A → G
<b>BOLLA</b>	F354085100TRNE	 LED 1x14W E27 (2700K, 1521Lm) or  HA 1x77W E27 (2800K, 1320Lm)	A → G
	F354090100TRNE	 LED 1x14W E27 (2700K, 1521Lm) or  HA 1x77W E27 (2800K, 1320Lm)	A → G
<b>CHANDELIER</b>	F549180250..NE	 LED 14x4W E14 (2700K, 6580Lm) or  HA 14x40W E14 (2700K, 6860Lm)	A → G
	F549185250..NE	 LED 19x4W E14 (2700K, 8930Lm) or  HA 19x40W E14 (2700K, 9310Lm)	A → G
	F549190250..NE	 LED 8x4W E14 (2700K, 3760Lm)  + LED 14x4W E14 (2700K, 6580Lm) or  HA 8x40W E14 (2700K, 3920Lm)  + HA 14x40W E14 (2700K, 6860Lm)	A → G
	F549195250..NE	 LED 14x4W E14 (2700K, 6580Lm)  + LED 19x4W E14 (2700K, 8930Lm) or  HA 14x40W E14 (2700K, 6580Lm)  + HA 19x40W E14 (2700K, 8930Lm)	A → G
<b>CHESHIRE</b>	F425785350..NE	 LED 3x14W E27 (2700K, 1521Lm)	A → G
<b>FLÛTE</b>	F333795150TCNE	 HA 1x230W R7s/M15 (2900K, 5000Lm)	A → G
<b>GLOBO DI LUCE</b>	F364480150..NE	 LED 1x3,5W E14 (2700K, 230Lm) or  HA 1x40W E14 (2800K, 250Lm)	A → G
	F364485150..NE	 LED 1x3,5W G9 (2700K, 350Lm) or  HA 1x60W G9 (2800K, 980Lm)	A → G
	F364490150..NE	 LED 1x21W E27 (2700K, 2452Lm) or  HA 1x150W E27 (2900K, 2870Lm)	A → G
<b>HUNA</b>	F505985200..NE	 LED 1x21W E27 (2700K, 2452Lm) or  HA 1x116W E27 (2800K, 2135Lm)	A → G
<b>LAMPARA</b>	F500090200..NE	 LED 1x21W E27 (2700K, 2452Lm) or  HA 1x116W E27 (2800K, 2135Lm)	A → G
<b>PALLINA</b>	F443080150..NE	 LED 1x6W G9 (2700K, 470Lm)	A → G
<b>PANGEN</b>	F419685350..NE	 LED 3x9W E27 (2700K, 300Lm) or  HA 3x46W E27 (2700K, 700Lm)	A → G
<b>PAROLA</b>	F428485100..NE	 LED 1x3,5W G9 (3000K, 400Lm)	A → G

Questa tabella raccoglie le informazioni necessarie per l'acquisto corretto della fonte luminosa (esclusi i modelli con LED integrati).  
La classe energetica del prodotto dipende dalla sorgente luminosa utilizzata.

Famiglia Family	Codice prodotto Product code	Lampadine consigliate Recommended light source	Etichetta energetica Energy Label
<b>PINECONE</b>	F436385550..NE	 LED 1x21W E27 (2700K, 2452Lm) or  HA 1x116W E27 (2800K, 2135Lm)	A → G
	F433990550..NE	 LED 1x21W E27 (2700K, 2452Lm) or  HA 1x116W E27 (2800K, 2135Lm)	A → G
<b>SCINTILLA</b>	FS15085250..NE	 HA 1x120W R7s/80 (2900K, 2250Lm)	A → G
	FS30090250..NE	 HA 1x230W R7s/115 (2900K, 5000Lm)	A → G

# LEGENDA / LEGEND



Marchio obbligatorio che attesta la conformità del prodotto alle disposizioni delle direttive e regolamenti comunitari.  
Mandatory marking certifying the conformity of the product to the community directives and rules.



Il Certificato di conformità EAC (EurAsian Conformity) indica che i prodotti si adeguano a tutte le normative tecniche delle procedure di valutazione dell'Unione doganale eurasiatica.  
The EurAsian Conformity mark (EAC) is a certification mark to indicate that the products conform to all technical regulations of the Eurasian Customs Union.



Marchio di certificazione per il mercato nord americano che certifica che il prodotto è conforme e rispetta i requisiti delle normative nordamericane.  
Mark of certification for the american market that certifies that the product is conform to the North American standards.



Marchio di Certificazione Cinese.  
China Compulsory Certification.



Indice di protezione contro la penetrazione di corpi solidi e di liquidi.  
Protection degree offered by the fixture to the ingress of solids and liquids.



La prima cifra indica, protezione contro la penetrazione di corpi solidi:

- (0) Nessuna protezione
  - (1) Protezione contro i corpi solidi di dimensioni superiori a 50mm
  - (2) Protezione contro i corpi solidi di dimensioni superiori a 12mm
  - (3) Protezione contro i corpi solidi di dimensioni superiori a 2,5mm
  - (4) Protezione contro i corpi solidi di dimensioni superiori a 1mm
  - (5) Protezione contro la polvere
  - (6) Totalmente protetto contro la polvere.
- The first number is the protection rating against solid objects:
- (0) No protection
  - (1) Protected against solid bodies over 50 mm in diameter
  - (2) Protected against solid bodies over 12 mm in diameter
  - (3) Protected against solid bodies over 2,5 mm in diameter
  - (4) Protected against solid bodies over 1 mm in diameter
  - (5) Protected against dust
  - (6) Fully protected against dust.



La seconda cifra indica, protezione contro l'infiltrazione di acqua:

- (0) Nessuna protezione
  - (1) Protezione contro la caduta in verticale di gocce d'acqua
  - (2) Protezione contro la caduta in verticale di gocce d'acqua con angolo di inclinazione massimo di 15°
  - (3) Protezione contro la caduta in verticale di gocce d'acqua con angolo di inclinazione massimo di 60°
  - (4) Protezione contro gli spruzzi d'acqua
  - (5) Protezione contro i getti d'acqua
  - (6) Protezione contro le ondate d'acqua
  - (7) Protezione contro l'immersione
  - (8) Protezione contro l'immersione prolungata.
- The second number is the protection against liquids:
- (0) No protection
  - (1) Protected against drops of water falling vertically
  - (2) Protected against drops of water at a max. inclination of 15 degrees
  - (3) Protected against drops of water at a max. inclination of 60 degrees
  - (4) Protected against splashed of water
  - (5) Protected against jets of water
  - (6) Protected against waves
  - (7) Protected against immersion
  - (8) Protected against long term immersion.

## Classe II



Apparecchio in cui la protezione contro la scossa elettrica non si basa unicamente sull'isolamento principale, ma anche su misure supplementari di sicurezza quali il doppio isolamento o l'isolamento rinforzato. Questi apparecchi non prevedono la messa a terra.  
Light fittings whose safety is guaranteed only by the double and / or reinforced insulation of all parts, with no earth.

## Classe III



Apparecchio in cui la protezione contro la folgorazione elettrica si basa sull'alimentazione a bassissima tensione e in cui non si producono tensioni superiori alla stessa (SELV).  
Light fitting fitted with a protection device against electric shock that features a very low voltage power supplied and prevents it from generating higher voltages (SELV).

## CRI

Indice di resa cromatica.  
Colour rendering index.



VETRO SOFFIATO  
BLOWN GLASS

Il procedimento per dare una forma al vetro è la soffiatura: libera o a stampo. La tecnica di soffiatura può essere variata utilizzando stampi di ferro, bronzo o legno bagnato. In queste forme viene soffiata la massa vitrea, ripetutamente scaldata, che si modella dilatandosi e sagomandosi. La soffiatura del vetro è un'arte che non ha età.

The procedure for shaping glass is blowing: free or moulded. The blowing technique can be varied by using moulds made of iron, bronze or wet wood. Into these forms the heated glass mass is blown and shaped by expanding. Glassblowing is an ageless art.



Prodotto disponibile anche in versione da tavolo  
Product also available in table version



Prodotto disponibile anche in versione da terra  
Product also available in floor version



Prodotto disponibile anche in versione a plafone  
Product also available in ceiling version



Prodotto disponibile anche in versione a parete  
Product also available in wall version



Prodotto disponibile anche in versione a sospensione  
Product also available in suspension version



Pronta consegna  
Ready to ship

#### NOTE TECNICHE DIMMER

**Dimmer:** apparecchio dimmerabile tramite pulsante presente sulla lampada o sul cavo (infrarad, microswitch, push button, slider control, touch).

**Dimmerabile (si):** apparecchio dimmerabile tramite pulsante remoto adatto a gestire sorgenti dimmerabili (alogene, fluorescenti, LED retrofit).

**Dimmerabile (Push):** apparecchio dimmerabile tramite pulsante remoto adatto a gestire driver di tipo Push.

**Dimmerabile (1-10V):** apparecchio dimmerabile tramite pulsante remoto adatto a gestire driver di tipo 1-10V.

**Dimmerabile a taglio di fase:** apparecchio dimmerabile solo con dimmer per moduli LED a tensione di rete.

**Dimmerabile TRIAC:** I dimmer TRIAC più recenti possono dimmerare lampade a LED

#### DIMMER TECHNICAL NOTES

**Dimmer:** dimmable fixture by means of a switch situated on the lamp structure or on cable (infrared, microswitch, push button, slider control, touch).

**Dimmable (yes):** dimmable fixture by means of a remote switch able to manage dimmable sources (halogens, fluorescents, LED Retrofit).

**Dimmable (Push):** dimmable fixture by means of a remote switch able to manage Push Drivers.

**Dimmable (1-10V):** dimmable fixture by means of a remote switch able to manage 1.10V Drivers.

**Dimmable with phase cut dimmer:** dimmable fixture only with dimmer for LED modules for mains voltage.

**Dimmerabile TRIAC:** The latest TRIAC dimmers can dim LED lamps

# CONDIZIONI DI VENDITA / SALES CONDITION

## DIRETTIVA RAEE RIFIUTI APPARECCHIATURE ELETTRICHE E ELETTRONICHE

Il 14 Marzo 2014 il Consiglio dei Ministri ha recepito con il Decreto Legislativo nr. 49/2014 la nuova Direttiva Europea EU 2012/19/UE relativa alla raccolta e smaltimento dei rifiuti derivati da apparecchiature elettriche ed elettroniche. La modalità con la quale il Decreto ha messo a disposizione dei produttori di apparecchiature elettriche e elettroniche la possibilità di finanziare le attività di recupero e smaltimento dei rifiuti derivanti da tali apparecchiature è denominata eco-contributo; modalità che viene utilizzata da tutti i produttori aderenti al consorzio Ecolight, tra i quali FontanaArte. L'eco-contributo RAEE è incorporato nel prezzo di vendita. Gli esportatori abituali ed occasionali sono esenti dall'eco-contributo RAEE.

Numero iscrizione Registro Apparecchiature Elettriche e Elettroniche: IT612000009612 (AEE) / DE37033037 (EAR)

## CONDIZIONI GENERALI DI VENDITA AL CLIENTE RIVENDITORE

- Le presenti condizioni generali di vendita ("Condizioni") sostituiscono ed annullano le precedenti edizioni, disciplinano i rapporti contrattuali instaurati tra FontanaArte S.p.A. ("FontanaArte") e i rispettivi rivenditori, aventi a oggetto la fornitura di prodotti FontanaArte ("Prodotti"), come di volta in volta indicati nell'ordine di acquisto ("Ordine") emesso - in qualsiasi forma e con qualsiasi mezzo - dal rivenditore e confermato da FontanaArte.
- Le seguenti Condizioni - indicate in listino e di volta in volta aggiornate e caricate sul sito web [www.fontanaarte.com](http://www.fontanaarte.com) - vengono integralmente e automaticamente accettate dal rivenditore con trasmissione in qualsiasi forma e su qualsiasi supporto dell'Ordine dal rivenditore a FontanaArte. Con la trasmissione dell'Ordine il rivenditore conferma, quindi, di conoscere ed accettare le Condizioni. È esclusa l'applicazione di ogni altro termine, condizione o previsione del rivenditore. Qualora il rivenditore non condividesse alcuni dei termini riportati nelle Condizioni, FontanaArte invita il rivenditore medesimo a non inoltrare l'Ordine per l'acquisto dei Prodotti. Al momento dell'invio di qualsiasi Ordine da parte del rivenditore a FontanaArte, sarà onere e cura del rivenditore medesimo verificare il contenuto delle Condizioni come di volta in volta aggiornate da FontanaArte e da quest'ultima pubblicate sul proprio sito web sopra indicato.
- FontanaArte si riserva il diritto in qualsiasi momento di eliminare i Prodotti dalle proprie collezioni o cataloghi e di apportare variazioni di prezzo o altre modifiche derivanti da esigenze tecniche o commerciali. Dette variazioni non troveranno applicazione per i Contratti, come definiti sotto, già conclusi prima della notifica della relativa variazione, da parte di FontanaArte al rivenditore.
- La fornitura avviene sempre ai prezzi indicati nel listino di FontanaArte ed alle condizioni in vigore alla data della conferma d'Ordine. Salvo quanto diversamente concordato tra le parti, non sono effettuati riduzioni o sconti sul valore dei prezzi di listino.
- L'emissione di qualsiasi Ordine costituisce una proposta contrattuale, dal rivenditore a FontanaArte, di acquistare i Prodotti ai sensi delle presenti Condizioni. L'Ordine si ritiene accettato solo ove FontanaArte (a) emetta una conferma d'Ordine scritta o (b) proceda con la fornitura dei Prodotti, ai sensi dell'Ordine, considerandosi tale fatto quale accettazione tacita.
- Qualora la conferma d'Ordine emessa da FontanaArte rechi qualsiasi modifica rispetto al contenuto del relativo Ordine (ivi incluse le presenti Condizioni), la conferma dell'Ordine sarà automaticamente considerata quale nuova proposta contrattuale, formulata da FontanaArte, che dovrà essere accettata dal rivenditore. Non si accettano annullamenti di Ordini già trasmessi e confermati a meno di un accordo scritto tra le parti.
- Il contratto tra FontanaArte e il rivenditore per la fornitura dei Prodotti ("Contratto" - il Contratto è formato dalle Condizioni e dall'Ordine accettato da FontanaArte ovvero dalla contro proposta di FontanaArte accettata dal rivenditore) si intende concluso (i) alla data di accettazione scritta dell'Ordine da parte di FontanaArte; o (ii) nel tempo in cui ha avuto inizio l'esecuzione (in caso di accettazione tacita nei termini di cui sopra) in caso di accettazione della controproposta da parte del rivenditore.
- Il rivenditore è tenuto a controllare la correttezza della conferma d'Ordine e delle condizioni, incluse le condizioni di vendita e di pagamento, ivi indicate.
- I Prodotti saranno consegnati secondo le modalità e nel luogo indicati nell'Ordine confermato ("Luogo di Consegna"). Salvo ove diversamente convenuto tra le parti,

la consegna dei Prodotti è effettuata presso il Luogo di Consegna alle condizioni riportate di seguito:

- Franco destino per ordini di valore superiore a € 1.000,00;
- Addebito percentuale del 7% sul valore imponibile da € 500,00 a € 1.000,00;
- Addebito in fattura di € 50,00 per ordini fino a € 500,00.

Le condizioni sopracitate sono valide per i seguenti paesi:

Italia, Francia, Spagna (escluse isole), Austria, Svizzera, Germania, Belgio, Lussemburgo, Paesi Bassi e Slovenia. Per gli altri paesi consultare il Customer Service.

- Il trasferimento del rischio dal Fornitore al rivenditore avviene dal momento della consegna dei Prodotti nel Luogo di Consegna. Dal quel momento grava sul rivenditore il rischio di perimento, smarrimento o danneggiamento dei Prodotti.
- Il rivenditore potrà rivendere i Prodotti ai clienti finali nello svolgimento ordinario della sua attività imprenditoriale. È vietata la vendita dei Prodotti a soggetti che li acquistino per la rivendita.
- I Prodotti FontanaArte sono garantiti per 2 anni. I reclami relativi ad eventuali Prodotti difettosi potranno essere accettati e la conseguente procedura per resi e sostituzioni dei Prodotti o delle parti difettose di questi ultimi potrà essere attivata solo dietro la presentazione della copia del documento fiscale attestante il relativo acquisto, e corretta compilazione dell'apposito modulo di reclamo. Non si accettano reclami notificati a FontanaArte dopo 8 giorni dal ricevimento dei Prodotti.
- Non si accettano resi se non preventivamente autorizzati per iscritto da FontanaArte. Il reso dei Prodotti dovrà essere effettuato unicamente tramite lo spedizioniere ufficiale indicato da FontanaArte che sarà preventivamente, senza alcun accredito, autorizzato ad effettuare il ritiro. I Prodotti devono essere resi negli imballi originali. Al ricevimento dei Prodotti resi, il reparto resi clienti di FontanaArte effettuerà un controllo di detti Prodotti. In caso di riscontro di difetti di produzione la sostituzione dei Prodotti verrà effettuata a titolo gratuito. Qualora il difetto riscontrato non possa essere considerato come un vizio di produzione, i Prodotti resteranno a disposizione per il ritiro da parte del rivenditore per 30 giorni dalla data in cui è stato comunicato l'esito del controllo al rivenditore. Trascorso tale termine senza istruzioni da parte del rivenditore, detti Prodotti verranno distrutti senza che il rivenditore abbia diritto ad alcunché in relazione a quanto precede.
- Salvo dolo o colpa grave e qualsiasi altra ipotesi di responsabilità che non può essere esclusa o limitata ai sensi delle disposizioni inderogabili di legge, FontanaArte non sarà responsabile nei confronti del rivenditore per un importo superiore al prezzo pagato dal rivenditore ai sensi di ciascun Contratto e/o per qualunque tipo di danni indiretti.
- FontanaArte ha la facoltà di sospendere la fornitura dei Prodotti quando le condizioni finanziarie o patrimoniali del rivenditore risultino tali da porre in evidente pericolo il conseguimento del pagamento dovuto o per altri motivi di carattere commerciale e di gestione di FontanaArte.
- Il mancato o ritardato pagamento dei corrispettivi dovuti a FontanaArte dal rivenditore nei termini previsti dal Contratto comporta un addebito di interessi pari all'3% sull'ammontare di ciascuna fattura relativa ai Prodotti acquistati per ogni mese di ritardo dalla scadenza indicata nel Contratto.
- FontanaArte si riserva il diritto di modificare qualsiasi delle precedenti clausole a proprio insindacabile giudizio e senza obbligo di fornire preavviso al rivenditore, restando inteso che ciascuna modifica entrerà in vigore con riferimento a qualsiasi Contratto concluso successivamente all'avenuta notifica, da parte di FontanaArte al rivenditore mediante pubblicazione delle Condizioni aggiornate sul sito web di FontanaArte, della modifica medesima.
- Ciascun Contratto è regolato e interpretato ai sensi della legge della Repubblica Italiana.
- Per ogni controversia che dovesse insorgere tra le parti in relazione a ciascun Contratto è competente in via esclusiva il Tribunale di Milano.

## WEEE DIRECTIVE ON WASTE FROM ELECTRICAL AND ELECTRONIC EQUIPMENT

On 14 March 2014 the Council of Ministers ratified with Legislative Decree No. 49/2014 the new European Directive 2012/19/EU on the collection and disposal of waste from electrical and electronic equipment. The mechanism introduced with the Decree by which manufacturers of electrical and electronic equipment may finance the recovery and disposal of waste from such equipment is called the eco-contribution.

The mechanism has been adopted by all manufacturers belonging to the Ecolight consortium, among them FontanaArte.

The WEEE eco-contribution is included in the sale price.

Routine and occasional exporters are exempt from the WEEE eco-contribution.

ELECTRICAL AND ELECTRONIC EQUIPMENT Registration Number: IT612000009612 (AEE) / DE37033037 (EAR)

## GENERAL TERMS AND CONDITIONS OF SALE FOR RETAILERS

- These general terms and conditions of sale ("Conditions") replace and nullify any previous versions governing the contractual relationships between FontanaArte S.p.A. ("FontanaArte") and the respective retailers regarding the supply of FontanaArte products ("Products"), as indicated in the purchase orders ("Order") issued - in whatever form and by any means - by the retailer and confirmed by FontanaArte.
- The following Conditions – specified in the price list and from time to time updated and uploaded to the web site [www.fontanaarte.com](http://www.fontanaarte.com) are fully and automatically accepted by the retailer when it sends the purchase order, in whatever form and on whatever support, to FontanaArte. With the sending of the Purchase Order the retailer therefore confirms that it understands and accepts the Conditions. Any other terms, conditions or provisions of the retailer are excluded. Should the retailer not agree with any of the terms and conditions, FontanaArte would ask the retailer not to send a Purchase Order for the Products. Whenever the retailer sends FontanaArte a Purchase Order, it is the retailer's duty and responsibility to check the terms and conditions from time to time updated by FontanaArte and published on their web site.
- FontanaArte reserves the right at any time to remove Products from its collections or catalogues and to make price changes or other changes due to technical or commercial demands. These variations shall not apply to any Contracts, as defined below, that have already been concluded prior to the retailer's notification of the change by FontanaArte.
- The Products are always supplied at the prices indicated in the FontanaArte price list and at the conditions prevailing at the date of Order confirmation. Unless otherwise agreed between the parties, there shall be no reductions or discounts on the listed price.
- The issue of an Order represents a contractual proposal by the retailer to FontanaArte to purchase the Products under these Conditions. The Order is deemed to be accepted if FontanaArte (a) issues a written Order confirmation or (b) proceeds with the supply of the Products as indicated on the Order, this being taken as tacit acceptance.
- Should the Order confirmation issued by FontanaArte carry any variation with respect to the content of the Order (including these Conditions), the Order confirmation will automatically be considered a new contractual proposal by FontanaArte, which the retailer shall accept. Orders already transmitted and confirmed may not be cancelled except by written agreement between the parties.
- The contract between FontanaArte and the retailer for supply of the Products ("Contract" – the Contract is made up of the Conditions and the Order accepted by FontanaArte or by a counter-proposal by FontanaArte and accepted by the retailer) is understood to the concluded (i) at the date of written acceptance of the Order by FontanaArte; or (ii) at the moment execution begins (in the event of tacit acceptance as described above) and in the event of acceptance of a counter-proposal by the retailer.
- The retailer is required to check the accuracy of the Order confirmation and the Conditions, including the conditions of sales and payment specified therein.
- The Products shall be delivered in accordance with the procedures and in the places specified in the confirmed Order ("Place of Delivery"). Unless otherwise agreed between the parties, the Products will be delivered to the Place of Delivery at the following conditions:

- Free at destination for orders worth more than € 1.000,00;
- 7% charge on the taxable value from € 500,00 to € 1.000,00;
- € 50 charge on the invoice for orders of up to € 500.

The above-mentioned conditions are valid for the following countries:

Italy, France, Spain (excluding islands), Austria, Switzerland, Germany, Belgium, Luxembourg, the Netherlands and Slovenia. For other countries please consult Customer Service.

- The transfer of risk from Supplier to retailer occurs at the moment of delivery of the Products to the Place of Delivery. From that moment the retailer shall bear the risk of destruction of, loss of, or damage to, the Products.
- The retailer may resell the Products to end clients in the normal course of their business. It is forbidden to sell the Products to subjects that purchase them for resale.
- FontanaArte Products are guaranteed for 2 years. Claims regarding defective Products may be accepted and the ensuing procedure for the return and replacement of the Products or defective parts of same may be activated only on submission of a copy of the tax document attesting the order, and the correctly compiled claim form. Claims received by FontanaArte beyond 8 days after receipt of the Products will not be accepted.
- No returns will be accepted unless authorized in writing in advance by FontanaArte. Product returns shall be made exclusively by the official shipping agent named by FontanaArte who is authorized in advance to make the collection, without accreditation. Products must be returned in the original packaging. On receipt of the returned Products, the FontanaArte customer returns department will check the said Products. If production defects are found the Products will be replaced free of charge. Should the defect be deemed not to be a production defect, the Products will remain available for collection by the retailer for 30 days after the outcome of the check is communicated to the retailer. After that date, unless instructions are received from the retailer, the Products will be destroyed and the retailer will not be entitled to any reimbursement.
- Save criminal intent, or serious misconduct or any other liability that cannot be excluded or limited by binding provision of the law, FontanaArte shall not be liable to the retailer for an amount greater than the price paid by the retailer under the Contract or for any form of indirect damages.
- FontanaArte is entitled to suspend supply of the Products if the retailer's financial or capital circumstances are such as to clearly put at risk payment of the amounts due or for any other reasons on the part of FontanaArte of a commercial or business nature.
- Failure to pay or late payment of the amount due to FontanaArte by the retailer within the terms set forth in the Contract will entail a 3% interest charge on the amount invoiced for each Product purchase for each month's delay beyond the expiry date specified in the Contract.
- FontanaArte reserves the right to modify any of above clauses at its unchallengeable discretion and without the obligation of advance notice to the retailer, it being understood that any change will come into effect in Contracts concluded subsequent to communication of the change to the retailer by FontanaArte possibly via publication of the modified terms and conditions on FontanaArte's web site.
- Each Contract shall be governed and interpreted in accordance with Italian law.
- For any dispute that may arise between the parties in relation to any Contract the Courts of Milan shall have exclusive jurisdiction.

## DIRECTIVE SUR LES DÉCHETS D'ÉQUIPEMENTS ÉLECTRIQUES ET ÉLECTRONIQUES (DEEE)

Le 14 mars 2014, le Conseil des ministres [de la République italienne] a adopté le décret législatif n° 49/2014, lequel transpose la nouvelle directive européenne 2012/19/UE sur la collecte et l'élimination des déchets d'équipements électriques et électroniques. La manière dont le décret a mis à la disposition des producteurs d'équipements électriques et électroniques la possibilité de financer la valorisation et l'élimination des déchets de ces équipements est appelée écocontribution, une méthode qui est utilisée par tous les producteurs appartenant au consortium Ecolight, dont FontanaArte. L'écocontribution DEEE est incorporée dans le prix de vente. Les exportateurs réguliers et occasionnels sont exemptés de l'écocontribution DEEE.

Numéro d'enregistrement au Registre pour les équipements électriques et électroniques: IT612000009612 (AEE) / DE37033037 (EAR)

## CONDITIONS GÉNÉRALES DE VENTE POUR LE REVENDEUR

- Les présentes conditions générales de vente (« Conditions ») remplacent et annulent les éditions précédentes ; elles régissent les relations contractuelles établies entre la société FontanaArte S.p.A. (« FontanaArte ») et ses revendeurs, ayant pour objet la fourniture de produits FontanaArte (« Produits »), comme indiqué au cas par cas dans le bon de commande (« Commande ») émis - sous n'importe quelle forme et avec tout moyen quel qu'il soit - par le revendeur.
  - Les suivantes Conditions – indiquées sur le catalogue de prix, mises à jour au cas par cas et insérées sur le site Internet [www.fontanaarte.com](http://www.fontanaarte.com) sont acceptées intégralement et automatiquement par le revendeur dès que ce dernier transmet, sous n'importe quelle forme et sur tout support quel qu'il soit, une Commande à FontanaArte. En transmettant une Commande, le revendeur confirme donc qu'il connaît les conditions et qu'il les accepte. L'application de tout autre terme, condition ou prévision du revendeur est exclue. Au cas où le revendeur ne serait pas d'accord avec certains termes indiqués dans les Conditions, FontanaArte invitera ledit revendeur à ne pas envoyer de Commande d'achat de Produits. Au moment où le revendeur enverra toute Commande quelle qu'elle soit à FontanaArte, il sera tenu de vérifier le contenu des Conditions mises à jour au cas par cas par la société FontanaArte et publiées par cette dernière sur le site Web mentionné ci-dessus.
  - FontanaArte se réserve le droit, à tout moment, de retirer des produits de ses collections ou catalogues et d'effectuer des changements de prix ou d'autres modifications résultant de besoins techniques ou commerciaux. Ces modifications ne s'appliqueront pas aux Contrats, tels que définis ci-dessous, déjà conclus avant la notification de la modification par FontanaArte au revendeur.
  - La livraison s'effectue toujours aux prix indiqués dans le tarif FontanaArte et selon les conditions en vigueur à la date de la confirmation de la Commande. Sauf accord contraire convenu entre les parties, aucune réduction ou rabais n'est accordé sur la valeur des prix du catalogue.
  - L'émission de toute commande constitue une proposition contractuelle, transmise à FontanaArte par le revendeur, d'acheter les Produits conformément aux présentes Conditions. La Commande n'est considérée comme acceptée que si FontanaArte (a) délivre une confirmation de Commande écrite ou (b) procède à la fourniture des Produits, conformément à la Commande, considérant ce fait comme une acceptation tacite.
  - Si la confirmation de Commande émise par FontanaArte fait apparaître une modification du contenu de la Commande concernée (y compris les présentes Conditions), la confirmation de Commande sera automatiquement considérée comme une nouvelle proposition contractuelle, formulée par FontanaArte, qui devra être acceptée par le revendeur. Les annulations de commandes déjà envoyées et confirmées ne seront pas acceptées sauf accord écrit entre les parties.
  - Le contrat entre FontanaArte et le revendeur pour la fourniture des Produits (« Contrat ») - le Contrat se compose des Conditions et de la Commande acceptée par FontanaArte ou de la contre-proposition de FontanaArte acceptée par le revendeur) est réputé conclu (i) à la date de l'acceptation écrite de la Commande par FontanaArte; ou (ii) au moment où l'exécution commence (en cas d'acceptation tacite aux conditions énoncées ci-dessus) et en cas d'acceptation de la contre-proposition de la part du revendeur.
  - Le revendeur est tenu de vérifier l'exactitude de la confirmation de Commande et des Conditions, y compris les conditions de vente et de paiement, qui y sont indiquées.
  - Les Produits seront livrés de la manière et au lieu indiqués dans la Commande confirmée (« Lieu de livraison »). Sauf accord contraire entre les parties, la livraison des Produits est effectuée au Lieu de livraison selon les conditions définies ci-après :
    - Franco destination pour les commandes d'une valeur supérieure à 1.000,00 € ;
    - Frais de 7% sur la valeur imposable de 500,00 € à 1.000,00 € ;
    - Majoration de la facturation de 50,00 € pour les commandes jusqu'à 500,00 €.
- Les conditions ci-dessus sont valables pour les pays suivants : Italie, France, Espagne (à l'exclusion des Isles), Autriche, Suisse, Allemagne, Belgique, Luxembourg, Pays-Bas et Slovénie
- Le transfert des risques du Fournisseur au revendeur a lieu à partir du moment où les Produits sont livrés au Lieu de livraison. À partir de ce moment, le risque de destruction, de perte ou d'endommagement des Produits est à la charge du revendeur
  - Le revendeur peut revendre les produits à des clients finaux dans le cadre de ses activités. Il est interdit de vendre les Produits à des personnes les achetant dans le but de les revendre.
  - Les produits FontanaArte sont garantis 2 ans. Les réclamations relatives à d'éventuels Produits défectueux pourront être acceptées et la procédure conséquentaire pour les retours et les remplacements des Produits ou des pièces défectueuses de ces dernières, pourra être activée seulement après la présentation de la copie du document fiscal attestant l'achat en question et la compilation correcte du formulaire de réclamation. On ne va pas accepter les réclamations notifiées à FontanaArte après 8 jours de la réception des Produits.
  - Aucune restitution de marchandise ne sera acceptée si elle n'a pas été préalablement autorisée par FontanaArte. La restitution des Produits ne devra être effectuée que par l'intermédiaire du transporteur officiel indiqué par FontanaArte qui sera préalablement, sans aucun crédit, autorisé à effectuer le retrait. Les Produits devront être restitués dans leur emballage d'origine. Dès la réception des Produits restitués, le service des retours clients de FontanaArte vérifiera les Produits. En cas de défaut de fabrication, le remplacement des Produits sera effectué gratuitement. Si le défaut constaté ne peut être considéré comme un vice de fabrication, le revendeur fera en sorte que les Produits restent disponibles pour le retrait pendant trente jours à compter de la date à laquelle le résultat de l'inspection aura été communiqué au revendeur. Passé ce délai, sans instructions du revendeur, ces produits seront détruits sans que le revendeur n'ait droit à quoi que ce soit en rapport avec ce qui précède.
  - Sauf en cas de faute intentionnelle ou de négligence grave et de toute autre responsabilité qui ne peut être exclue ou limitée en vertu des dispositions impératives de la loi, FontanaArte ne sera pas responsable envers le revendeur pour un montant supérieur au prix payé par le ce dernier en vertu de chaque contrat et / ou pour tout type de dommages indirects.
  - FontanaArte a le droit de suspendre la fourniture des Produits lorsque les conditions financières ou les actifs du revendeur sont de nature à mettre en danger la réalisation du paiement dû ou pour d'autres raisons de nature commerciale et de gestion de FontanaArte.
  - Le non-paiement ou le retard de paiement des sommes dues à FontanaArte par le revendeur selon les termes du Contrat entraînera l'application d'un intérêt de 3 % sur le montant de chaque facture des Produits achetés pour chaque mois de retard, à compter du jour indiqué dans le Contrat.
  - FontanaArte se réserve le droit de modifier l'une quelconque des clauses ci-dessus à sa seule discrétion et sans obligation de notification au revendeur, étant entendu que toute modification entrera en vigueur pour tous les Contrats conclus après notification transmise au revendeur par FontanaArte, éventuellement en publiant les Conditions mises à jour sur le site Internet de FontanaArte, de ladite modification.
  - Chaque Contrat est régi et interprété conformément à la loi de la République italienne.
  - Pour tout litige susceptible de survenir entre les parties en relation avec chaque Contrat, le Tribunal de Milan sera seul compétent.



## RICHTLINIE ÜBER ELEKTRO- UND ELEKTRONIKALTGERÄTE

Altgeräten umgesetzt. Die Art und Weise, in der das Dekret den Herstellern von Elektro- und Elektronikgeräten die Möglichkeit bietet, die Rückgewinnung und Entsorgung von Abfällen aus solchen Geräten zu finanzieren, wird als Ökoabgabe bezeichnet, eine Modalität, die von allen Herstellern des Ecolight-Konsortiums, einschließlich FontanaArte, angewandt wird.

Die Öko-Abgabe WEEE ist im Verkaufspreis einbezogen.

Regelmäßige und gelegentliche Exporteure sind von der WEEE-Ökoabgabe befreit.

Registrierungsnummer für Elektro- und Elektronikgeräte: IT6120000009612 (AEE) / DE37033037 (EAR)

## ALLGEMEINE VERKAUFSBEDINGUNGEN FÜR HÄNDLER

- Diese Allgemeinen Verkaufsbedingungen („Bedingungen“) ersetzen und annullieren alle früheren Ausgaben. Sie regeln die vertraglichen Beziehungen zwischen FontanaArte S.p.A. („FontanaArte“) und ihren jeweiligen Händlern, die die Lieferung von FontanaArte-Produkten („Produkte“) zum Gegenstand haben, wie sie von Mal zu Mal in der vom Händler – in jeglicher Form und egal mit welchen Mitteln – erteilten und von FontanaArte bestätigten Bestellung („Bestellung“) angegeben sind.
- Nachstehende, in der Preisliste angegebenen, von Zeit zu Zeit aktualisierten und auf der Website [www.fontanaarte.com](http://www.fontanaarte.com) hochgeladenen Bedingungen – werden mit der Übermittlung in jeglicher Form und mit jedem Medium der Bestellung an FontanaArte vom Händler vollständig und automatisch akzeptiert. Mit der Übermittlung der Bestellung bestätigt der Händler daher, die Bedingungen zu kennen und zu akzeptieren. Andere Bedingungen, Fristen oder Prognosen des Händlers sind ausgeschlossen. Sollte der Händler mit einigen der in den Bedingungen enthaltenen Punkten nicht einverstanden sein, fordert FontanaArte den Einzelhändler auf, die Bestellung zum Kauf der Produkte nicht aufzugeben. Zum Zeitpunkt der Absendung einer Bestellung durch den Händler an FontanaArte liegt es in der Verantwortung und Sorgfalt des Händlers, den Inhalt der Bedingungen zu überprüfen, die von FontanaArte von Zeit zu Zeit aktualisiert und auf seiner oben genannten Website veröffentlicht werden.
- FontanaArte behält sich das Recht vor, jederzeit Produkte aus seinen Kollektionen oder Katalogen zu entfernen und Preisänderungen oder andere Änderungen vorzunehmen, die sich aus technischen oder kommerziellen Gründen ergeben. Besagte Änderungen gelten jedoch nicht für wie nachstehend definierte Verträge, die vor der Bekanntgabe der jeweiligen Änderung durch FontanaArte an den Händler abgeschlossen wurden.
- Die Lieferung erfolgt stets zu den in der Preisliste von FontanaArte angegebenen Preisen und zu den am Tag der Auftragsbestätigung gültigen Bedingungen. Sofern zwischen den Parteien nichts anderes vereinbart wird, werden auf den Wert der Listenpreise keine Ermäßigungen oder Rabatte gewährt.
- Die Erteilung einer Bestellung stellt ein vertragliches Angebot des Händlers an FontanaArte dar, die Produkte unter vorliegenden Bedingungen zu kaufen. Die Bestellung gilt nur dann als angenommen, wenn FontanaArte (a) eine schriftliche Auftragsbestätigung ausstellt oder (b) die Produkte in Übereinstimmung mit der Bestellung liefert, wobei diese Tatsache als stillschweigende Annahme betrachtet wird.
- Zeigt die von FontanaArte herausgegebene Auftragsbestätigung eine Änderung des Inhalts der jeweiligen Bestellung (einschließlich dieser Bedingungen) auf, so gilt die Auftragsbestätigung automatisch als neues Vertragsangebot von FontanaArte, das vom Händler akzeptiert werden muss. Stornierungen von bereits übermittelten und bestätigten Bestellungen werden nicht akzeptiert, es sei denn, es besteht eine schriftliche Vereinbarung zwischen den Parteien.
- Der Vertrag zwischen FontanaArte und dem Händler über die Lieferung der Produkte („Vertrag“ – der Vertrag setzt sich aus den Bedingungen und der von FontanaArte akzeptierten Bestellung oder durch das vom Händler akzeptierte Gegenangebot von FontanaArte zusammen) gilt in folgenden Fällen als abgeschlossen: (i) am Tag der schriftlichen Bestellsannahme durch FontanaArte; oder (ii) in dem Zeitpunkt, in dem die Ausführung begonnen hat (im Falle der stillschweigenden Annahme zu den oben genannten Bedingungen) und im Falle der Annahme des Gegenangebots durch den Händler.
- Der Händler ist verpflichtet, die Richtigkeit der Auftragsbestätigung und der darin angegebenen Bedingungen, einschließlich der Verkaufs- und Zahlungsbedingungen, zu überprüfen.
- Die Produkte werden in der Weise und an den Ort geliefert, der in der bestätigten Bestellung angegeben ist („Lieferort“). Sofern zwischen den Parteien nichts anderes vereinbart ist, erfolgt die Lieferung der Produkte zu den nachstehenden Bedingungen an den Lieferort:
  - Frei Bestimmungsort für Bestellungen ab einem Wert von € 1.000,00;
  - mit 7 % mehr in der Rechnung bei Bestellwerten zwischen € 500 und € 1.000,00;
  - mit € 50,00 mehr in der Rechnung bei Bestellwerten bis € 500,00.

Die oben genannten Konditionen gelten für folgende Länder: Italien, Frankreich, Spanien (Inseln nicht inbegriffen), Österreich, Schweiz, Deutschland, Belgien, Luxemburg, Niederland und Slowenien. Für andere Länder wenden Sie sich bitte an unseren Customer Service.

- Der Gefahrenübergang vom Lieferanten auf den Händler erfolgt ab dem Zeitpunkt, an dem die Produkte an den Lieferort geliefert werden. Von diesem Zeitpunkt an trägt der Händler das Risiko des Verfalls, des Verlustes oder der Beschädigung der Produkte.
- Der Händler kann die Produkte im Rahmen seiner normalen Geschäftstätigkeit an Endkunden weiterverkaufen. Es ist ihm verboten, die Produkte an Subjekte zu verkaufen, die sie zur Weiterveräußerung kaufen.
- Die Produkte FontanaArte haben 2 Jahre Garantie. Reklamationen im Zusammenhang mit fehlerhaften Produkten können akzeptiert werden, und das abschließende Verfahren zur Rückgabe und zum Austausch der Produkte oder ihrer fehlerhaften Teile kann nur gegen Vorlage einer Kopie des Steuerelements eingeleitet werden, das den jeweiligen Kauf bescheinigt, und verlangt das korrekte Ausfüllen des entsprechenden Reklamationsformulars. Beschwerden, die FontanaArte später als 8 Tage nach Erhalt der Produkte mitgeteilt werden, werden zurückgewiesen.
- Rücksendungen werden nur angenommen, wenn sie im Vorfeld von FontanaArte schriftlich genehmigt wurden. Die Rücksendung der Produkte darf nur über den von FontanaArte angegebenen offiziellen Spediteur erfolgen, der vorab, ohne jede Kostenanrechnung, zur Abholung ermächtigt werden wird. Die Produkte müssen in der Originalverpackung zurückgegeben werden. Nach Eintreffen der zurückgesandten Produkte wird die Abteilung für Kundenrücksendungen von FontanaArte die Produkte überprüfen. Im Falle von Herstellungsfehlern ist der Ersatz der Produkte kostenlos. Sollte der festgestellte Fehler nicht als Herstellungsfehler angesehen werden können, stehen die Produkte dem Händler ab dem Datum, 30 Tage lang zur Abholung zur Verfügung, an dem das Prüfungsergebnis dem Händler mitgeteilt wurde. Nach Ablauf dieser Frist ohne Weisung des Händlers werden diese Produkte vernichtet, ohne dass der Händler im Zusammenhang mit dem Vorstehenden Anspruch auf etwas hat.
- Außer bei Vorsatz oder grober Fahrlässigkeit und jeder anderen Haftung, die nach den zwingenden gesetzlichen Bestimmungen nicht ausgeschlossen oder beschränkt werden kann, haftet FontanaArte gegenüber dem Händler nicht für einen Betrag, der über dem vom Händler vertraglich vereinbarten Preis liegt, und/oder für indirekte Schäden jeglicher Art.
- FontanaArte ist berechtigt, die Lieferung von Produkten auszusetzen, wenn die Finanz- oder Vermögensbedingungen des Händlers fällige Zahlungen eindeutig gefährden oder wenn andere Gründe kommerzieller und verwaltungsspezifischer Art von FontanaArte gegeben sind.
- Bei Zahlungsausstand oder -verzug des Händlers gegenüber FontanaArte innerhalb der vertraglich vorgesehenen Fristen werden pro Monat Verspätung ab der im Vertrag angegebenen Frist 3 % Zinsen auf den jeweiligen Rechnungsbetrag für die gekauften Produkte erhoben.
- FontanaArte behält sich das Recht vor, jede der vorstehenden Klauseln nach eigenem Ermessen und ohne Verpflichtung zur Benachrichtigung des Händlers zu ändern, wobei jede Änderung erst in Kraft tritt, wenn sie sich auf einen Vertrag bezieht, der nach Mitteilung der Änderung vonseiten FontanaArte an den Händler abgeschlossen wurde, eventuell durch Veröffentlichung der aktualisierten Bedingungen auf der Website von FontanaArte.
- Jeder Vertrag unterliegt dem Recht der Italienischen Republik und wird in Übereinstimmung mit diesem ausgelegt.
- Für alle Streitfälle, die zwischen den Parteien in Bezug auf jeden Vertrag entstehen können, ist ausschließlicher Gerichtsstand das Gericht von Mailand.

## DIRECTIVA SOBRE RESIDUOS DE APARATOS ELÉCTRICOS Y ELECTRÓNICOS (RAEE)

El 14 de marzo de 2014, el Consejo de Ministros de la República Italiana traspuso la nueva Directiva Europea EU 2012/19/UE en materia de recogida y eliminación de residuos de aparatos eléctricos y electrónicos por medio del Decreto Legislativo N° 49/2014. Las modalidades, con que el Decreto puso a disposición de los fabricantes de aparatos eléctricos y electrónicos la posibilidad de financiar las actividades de recogida y eliminación de los residuos de dichos aparatos, se denominan eco-contribución. A dicha modalidad se acogen todos los fabricantes que forman parte del consorcio Ecolight, entre los cuales figura FontanaArte.

La eco-contribución RAEE está incluida en el precio de venta.

Los exportadores, habituales y ocasionales, se eximen de pagar la eco-contribución RAEE.

Número de inscripción en el Registro de Aparatos Eléctricos y Electrónicos:  
IT6120000009612 (AEE) / DE37033037 (EAR)

## CONDICIONES GENERALES DE VENTA PARA EL REVENDEDOR

- Las presentes condiciones generales de venta ("Condiciones") reemplazan y anulan las ediciones anteriores. Las mismas reglamentan las anulaciones contractuales que se hayan instaurado entre la sociedad anónima FontanaArte S.p.A. ("FontanaArte") y sus revendedores, cuyo objeto consista en el suministro de los productos de FontanaArte ("Productos"), conforme a lo indicado en el pedido de compra ("Pedido"), que extienda el revendedor en cada ocasión, por cualquier medio y bajo cualquier forma y que FontanaArte confirme.
  - El revendedor acepta automática e íntegramente las siguientes Condiciones, que se detallan en el listín de precios y se actualizan y cargan en la página Web [www.fontanaarte.com](http://www.fontanaarte.com) cada vez que corresponda, al remitir el Pedido a FontanaArte por cualquier medio y bajo cualquier forma. Por consiguiente, al remitir el Pedido, el revendedor confirma que conoce y acepta las Condiciones. Se descarta desde ya la aplicación de cualesquiera otros plazos, condiciones o previsiones del revendedor. Si el revendedor no está de acuerdo con algunas de las cláusulas que se aprecian en las Condiciones, FontanaArte le solicita que no remita el Pedido de los Productos. A la hora de remitir todo Pedido a FontanaArte, el revendedor, bajo su exclusiva responsabilidad, debe encargarse de constatar el contenido de las Condiciones que FontanaArte actualiza cada vez que corresponde y que, a la postre, publica en la página Web susodicha.
  - FontanaArte se reserva el derecho de eliminar los Productos de sus colecciones o catálogos en todo momento, al igual que el de modificar el precio u aportar otras variaciones que sean fruto de necesidades técnicas o comerciales. Dichas modificaciones o variaciones no se aplicarán a los Contratos (según la definición que figura más abajo) que se hayan formalizado antes de que FontanaArte remita al revendedor la notificación correspondiente.
  - Al suministro se le aplican siempre los precios que figuran en el listín FontanaArte y las condiciones en vigor en la fecha en que se confirme el Pedido en firme. Excepto en los casos en que las partes tomen otros acuerdos, los precios que figuran en el listín no se descontarán ni sufrirán disminución alguna.
  - Todo Pedido constituye una propuesta contractual que el revendedor remite a FontanaArte, con el objeto de comprar los Productos al amparo de las presentes Condiciones. El Pedido se considera aceptado en firme siempre y cuando FontanaArte (a) remita una confirmación de Pedido por escrito o (b) proceda a suministrar los Productos, a tenor del Pedido. En su caso, este hecho se considerará una aceptación tácita.
  - Si, en la confirmación del Pedido que FontanaArte remite, figura cualquier tipo de modificación del Pedido original (incluidas las presentes Condiciones), la confirmación del Pedido se ha de considerar automáticamente como una nueva propuesta contractual, que FontanaArte formula y que el revendedor deberá aceptar. No se aceptarán anulaciones de pedidos transmitidos y confirmados en firme, a menos que al respecto medie un acuerdo escrito entre las partes.
  - El contrato entre FontanaArte y el revendedor que tenga por objeto el suministro de los Productos ("Contrato" – el Contrato consta de las Condiciones y del Pedido aceptado en firme por FontanaArte o de la contrapropuesta de FontanaArte que el revendedor aceptó en firme) se considerará celebrado (1) en la fecha que figure en la aceptación escrita del Pedido por parte de FontanaArte; o (2) en el momento en que comience a ejecutarse (en los casos de aceptación tácita, con arreglo a los términos susodichos) y en los de aceptación de la contrapropuesta por parte del revendedor.
  - El revendedor debe controlar la corrección de la confirmación del Pedido y de las condiciones, incluidas las condiciones de venta y de pago que se indican en los mismos.
  - Los Productos se entregarán según las modalidades y en el lugar que se detallan en el Pedido confirmado en firme ("Lugar de Entrega"). Excepto de mediar otros acuerdos entre las partes, la entrega de los Productos se realizará en el Lugar de Entrega, de acuerdo con las condiciones que se aprecian a continuación:
    - Franco destino, cuando la cuantía del pedido sea superior a 1.000,00 € ;
    - Con un recargo del 7% sobre la cantidad imponible, para cuantías de 500,00 € a 1.000,00 € ;
    - Con un recargo de 50,00 € en la factura para pedidos de hasta 500,00 €.
- Las condiciones mencionadas son válidas para los siguientes países:  
Italia, Francia, España (excluidas las islas), Austria, Suiza, Alemania , Bélgica, Luxemburgo, Países Bajos y Eslovenia. Para otros países, consulte con el Servicio de Atención al Cliente.
- La transferencia del riesgo del Proveedor al revendedor tiene lugar en el momento en que se hace entrega de los Productos en el Lugar de Entrega. A partir de dicho momento, el riesgo de deterioro, pérdida o daños de los Productos recae en el revendedor.
  - El revendedor podrá vender los Productos a los clientes finales en el marco de sus actividades empresariales de rutina. Queda terminantemente prohibido vender los Productos a terceros que los compren con la finalidad de revenderlos.
  - Los Productos FontanaArte cuentan con una garantía de dos años. Será posible aceptar reclamaciones correspondientes a Productos defectuosos y tramitar el procedimiento de devolución y sustitución de los Productos o de las partes defectuosas de estos últimos, siempre y cuando se presente la copia del comprobante fiscal de la compra correspondiente y si el formulario de reclamación está debidamente cumplimentado. FontanaArte no aceptará reclamaciones que se le notifiquen después de 8 días de la recepción de los Productos.
  - FontanaArte no aceptará devoluciones que no haya autorizado previamente por escrito. La devolución de los Productos se deberá efectuar exclusivamente por medio del transportista oficial que indique FontanaArte. Por otro lado, FontanaArte deberá ser autorizada previamente a retirar los Productos sin recargo alguno. Los Productos se devolverán en sus embalajes originales. Al recibir los Productos devueltos, en la División Devoluciones de Clientes, FontanaArte controlará los Productos en cuestión. De detectar defectos de fábrica, sustituirá gratuitamente los Productos. Toda vez que el defecto detectado no se pueda considerar como defecto de fábrica, los Productos quedarán a disposición del revendedor, quien podrá retirarlos en un plazo de 30 días a contar desde la fecha en que FontanaArte comunique al revendedor los resultados del control. Una vez que haya expirado dicho plazo, sin instrucciones de parte del revendedor, dichos Productos serán destruidos y el revendedor no tendrá derecho alguno en relación con todo lo que se expone más arriba.
  - Excepto en casos dolosos o de culpa grave o en cualesquiera otros supuestos de responsabilidad que no se puedan descartar o acotar, a tenor de las prescripciones legales inderogables, FontanaArte no asumirá responsabilidad alguna frente al revendedor por un importe superior al precio que este haya abonado, en virtud de cada Contrato y/o de cualquier tipo de daño indirecto
  - FontanaArte está facultada para suspender el suministro de los Productos toda vez que las condiciones financieras o patrimoniales del revendedor conlleven un peligro evidente para la consecución del pago debido, o por otros motivos de carácter comercial y de gestión de FontanaArte.
  - De incurrir en impago o en morosidad en los pagos de las sumas de dinero que el revendedor debe a FontanaArte, a tenor de lo establecido en el Contrato, FontanaArte aplicará al importe de cada una de las facturas correspondientes a los Productos comprados un interés del 3%, por mes de retraso, a partir del plazo de pago que figure en el Contrato.
  - FontanaArte se reserva el derecho de modificar cualquier cláusula antedicha, en base a su propia decisión inapelable y sin necesidad de remitir preaviso alguno al revendedor. Las partes acuerdan que cada una de las modificaciones será de aplicación a cualquier Contrato que se formalice después de que FontanaArte notifique la modificación en cuestión al revendedor. De ser preciso, dicha notificación se llevará a cabo mediante la publicación de las Condiciones actualizadas en la página Web de FontanaArte.
  - Todos los Contratos se regularán e interpretarán al amparo de la legislación de la República Italiana.
  - De surgir controversias entre las partes, en relación con cada uno de los Contratos, el fuero competente será exclusivamente el Tribunal de Milán.

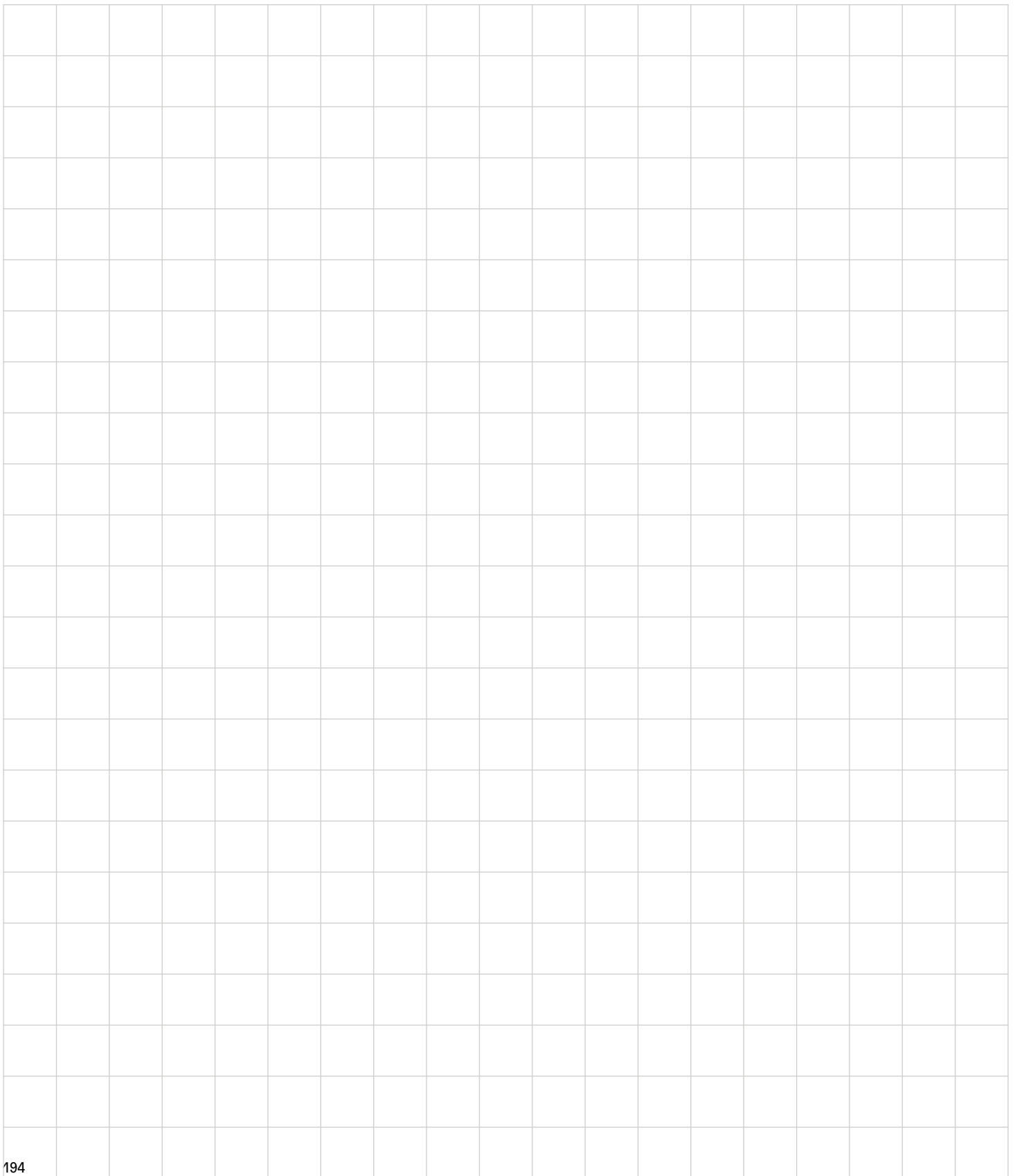

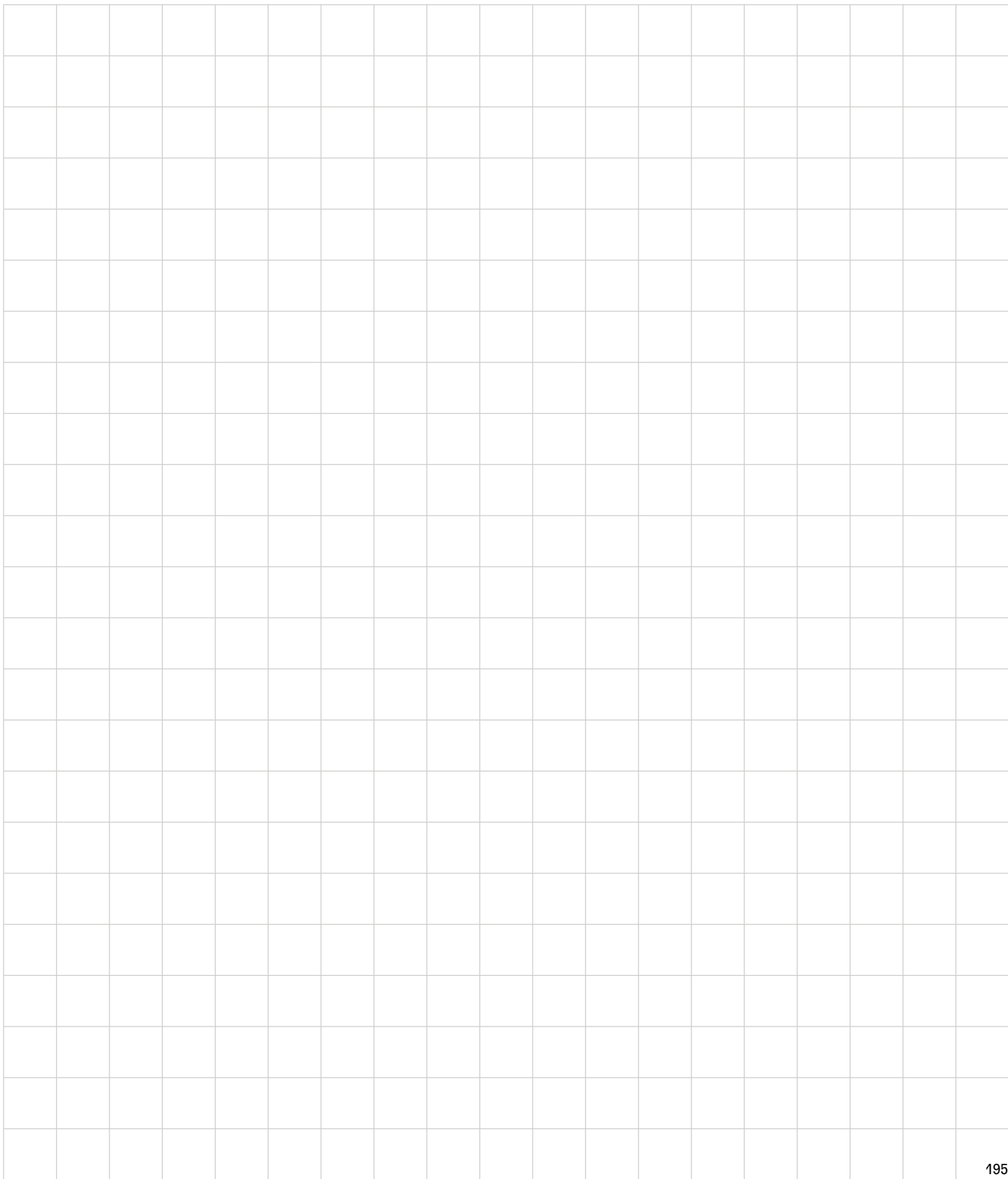

**SEDE / HEADQUARTERS**

**FONTANAARTE SPA**

Alzaia Trieste 49  
I-20094 Corsico (MI)  
Ph. +39 02 45121  
Fax +39 02 4512660 / 990  
info@fontanaarte.com  
P.I.: 09632850963

**ICGROUP US CORP**

152 Madison Ave, Suite # 1002  
New York, NY 10016, USA  
Ph. +1 (212) 334 3295

www.fontanaarte.com  
Instagram: fontanaarte

FontanaArte è azienda certificata  
ISO 9001:2015 con DNV - GL. Certificato  
nr. 178796-2015-AQ-ITA-ACCREDIA

FontanaArte has ISO 9001:2015  
certification from the DNV - GL. Certificate  
no. 178796-2015-AQ-ITA-ACCREDIA

1998  
ADI Compasso d'Oro  
Career Award



FontanaArte sostiene  
FontanaArte supports



Membro di  
Member of



Dal 1992 Fondazione Altagamma  
riunisce i marchi dell'eccellenza italiana  
famosi a livello internazionale.  
Since 1992 the Altagamma Foundation  
has gathered together high-end Italian  
brands famous at international level.