

driade

LISTINO PREZZI ARREDO 2023
FURNITURE PRICE LIST 2023

LISTINO PREZZI 2023
PRICE LIST 2023

INDOOR

driade

Fondata nel 1968, Driade ha raggiunto immediatamente un posizionamento estremamente riconoscibile nella fascia più esclusiva del mercato del design.

La reputazione di Driade è inevitabilmente legata a grandi designer e personalità della cultura, autori di icone: Philippe Starck, Ron Arad, Fabio Novembre, Patricia Urquiola, Rodolfo Dordoni, Konstantin Grcic, Antonia Astori, Enzo Mari, Alessandro Mendini, Borek Sipek, per citarne alcuni.

Una collezione che copre l'intera abitazione, da oggetti d'arte a strumenti per l'utilizzo quotidiano, oltre ad arredi per abitazioni uniche nel loro genere, giardini meravigliosi, uffici non convenzionali e spazi pubblici spettacolari.

Da quella stagione in cui il design ha determinato una nuova corrente di pensiero, funzione ed immagine, Driade ne è uno dei grandi oratori, capace di coniare in anticipo una koiné compresa a tutte le latitudini proprio in quanto scritta da lingue e linguaggi diversi.

Se fosse una città sarebbe New York o Londra o la Roma vissuta dal Caravaggio o più semplicemente la Milano della Famiglia Astori. Oggi abita in tante città, nelle dimore più esclusive o in quelle più stylish, provocando quel sinuoso equilibrio tra coerenza e cambiamento, tra rottura e cultura, seguendo quel mito della progettazione che va "dal cucchiaino alla città", in una collezione divenuta lifestyle.

Dopo cinque decenni, Driade rimane coerente con tale filosofia e gioia di vivere.

Driade rappresenta un mix eclettico di Rock, Pop, Sexy, Sofisticato e Sperimentale.

Ecco perché Driade è LABORATORIO ESTETICO!

Dal 2013, l'azienda entra a far parte di ItalianCreationGroup, polo del lusso Italiano dell'home design.

L'azienda è parte di Altagamma, la fondazione che riunisce dal 1992 le imprese dell'alta industria culturale e creativa che promuovono nel mondo l'eccellenza, l'unicità e lo stile di vita italiani.

driade

Founded in 1968, Driade quickly gained a well-recognised positioning in the High Luxury segment of the branded design furniture market.

Driade's reputation is linked to eminent designers and cultural personalities, authors of many icons: Philippe Starck, Ron Arad, Fabio Novembre, Patricia Urquiola, Rodolfo Dordoni, Konstantin Grcic, Antonia Astori, Enzo Mari, Alessandro Mendini, Borek Sipek among others.

The collection covers the whole home and ranges from objects of art to daily use tools, furniture for one of a kind houses, marvelous gardens, smart office and flamboyant public spaces.

From a season in which design determined a new trend in terms of mindset, function and image, Driade was one of the greatest representatives, being the first to invent a koiné that is understood at any latitude because written in different languages and codes.

If it were a city, it would be New York, London or even Rome at the time of Caravaggio, or more simply the Milano of the Astori Family. It now lives in many cities, in the most exclusive or stylish abodes, giving rise to a sinuous balance between coherence and change, break and culture, following the myth of design that goes "from the spoon to the town", in a collection that has become lifestyle.

After five decades Driade remains consistent by following this philosophy and joie de vivre.

Driade is an eclectic mix made of Rock, Pop, Sexiness, Sophistication and Experimentation.

That's why Driade is LABORATORIO ESTETICO!

Since 2013, the company has been part of ItalianCreationGroup, a luxury holding that operates in Home Design. The company is part of Altagamma, the Foundation that gathers High-End Italian Cultural and Creative Companies, recognized globally as authentic ambassadors of Italian style.

INDICE/ INDEX

INDOOR

Sedie, Poltroncine/ <i>Chairs, Armchairs</i>	pag.19
Sgabelli/ <i>Stools</i>	pag.46
<i>Pouf/Ottoman</i>	pag.51
Poltrone/ <i>Armchairs</i>	pag.59
Divani/ <i>Sofas</i>	pag.93
Tavoli/ <i>Tables</i>	pag.193
Tavolini/ <i>Coffee tables</i>	pag.227
Contenitori/ <i>Cabinets</i>	pag.245
Librerie/ <i>Bookshelves</i>	pag.265
Complementi d'arredo/ <i>Furnishing</i>	pag.273

OUTDOOR

Sedie, Poltroncine/ <i>Chairs, Armchairs</i>	pag.289
<i>Pouf/Ottoman</i>	pag.303
Sgabelli/ <i>Stools</i>	pag.306
Poltrone/ <i>Armchairs</i>	pag.308
Divani/ <i>Sofas</i>	pag.324
Tavoli, Tavolini/ <i>Tables, Coffee tables</i>	pag.332
Tessuti-Pelli/ <i>Fabrics-Leather</i>	pag.354
Libro delle finiture/ <i>Finishes Book</i>	pag.683
Condizioni generali di vendita/ <i>General terms of sale</i>	pag.758

INDICE TIPOLOGICO
TYPHOLOGICAL INDEX

SEDIE - POLTRONCINE/CHAIRS - ARMCHAIRS



COSTES
by Philippe Starck
P.20



LA FRANCESCA
by Lievore Altherr Molina
P.28



LAGO'
by Philippe Starck
P.29



LIBA
by Borek Sipek
P.32



LOU EAT
by P. Starck with D.Sugasawa
P.33



LOU EAT
by P. Starck with D.Sugasawa
P.33



MERIDIANA
by Christophe Pillet
P.34



MERIDIANA
by Christophe Pillet
P.36



MINGX
by Konstantin Grcic
P.37



MINGX
by Konstantin Grcic
P.37



MISS LACY
by Philippe Starck
P.38



PRATFALL
by Philippe Starck
P.24



S.MARCO
by M.Thun & A.Rodriguez
P.39



S.MARCO LOUNGE
by M.Thun & A.Rodriguez
P.40



SOF SOF
by Enzo Mari
P.41



SOIREE
by Oscar e Gabriele Buratti
P.42



TOTTORI
by Kateryna Sokolova
P.44



WE
by Fabio Novembre
P.45

SGABELLI/STOOLS



MERIDIANA
by Christophe Pillet
P.47



MILLEPIEDI
by Studio Catoir
P.48



MINGX
by Konstantin Grcic
P.49



MINGX
by Konstantin Grcic
P.49



PORTABLE ATELIER
by Philippe Nigro
P.50

POUF/OTTOMAN



ARCAD3
by Pow3r
P.53



BLOCCO
by Nanda Vigo
P.54



KOISHI
by Naoto Fukasawa
P.56

POLTRONE/ARMCHAIRS



COCKY
by DriadeLab
P.60



COCKY
by Sfera Ebbasta
P.65



ELISA
by Enzo Mari
P.66



HALL
by Rodolfo Dordoni
P.67



IPERCUBO
by De Pas, D'Urbino, Lomazzi
P.68



ITALIC
by Fabio Novembre
P.70



LIRICA
by L + R Palomba
P.72



LISA
by Laudani & Romanelli
P.73



LOU READ
by P.Starck with E.Quitlet
P.74



LOU SPEAK
by Philippe Starck
P.75



MOON
by L + R Palomba
P.76



NEIL
by L + R Palomba
P.78



NEMO
by Fabio Novembre
P.79



PAVO
by Patricia Urquiola
86



PAVO REAL
by Patricia Urquiola
P.87



SUKI
by Toyo Ito
P.88



TOTTORI
by Kateryne Sokolowa
P.89



VIGILIUS
by M.Thun & A.Rodriguez
P.90



WIREFLOW
by Michel Rojkind
P.91

DIVANI/SOFAS



33 CUSCINI
by Paolo Rizzatto
P.94



ELISA
by Enzo Mari
P.96



FENIX
by L + R Palomba
P.100



HALL
by Rodolfo Dordoni
P.116



LIRICO
by L + R Palomba
P.126



NEIL
by L + R Palomba
P.138



REVER
by L + R Palomba
P.154



TOTTORI
by Kateryna Sokolova
P.164



VERLAINE
by Lievore Altherr Molina
P.166



VIGILIUS
by M.Thun & A.Rodriguez
P.172



WOW
by Philippe Starck
P.174

**CUSCINI DECORATIVI/
THROW CUSHIONS**
P.188

TAVOLI/TABLES



ANAPO
by Gordon Guillaumier
P.194



CUGINO
by Enzo Mari
P.196



DIDYMOS
by Antonia Astori
P.198



EASEL
by L + R Palomba
P.202



FOURDROPS
by Oscar e Gabriele Buratti
P.206



FRANÇOIS
by Lievore Altherr
P.210



FRATE
by Enzo Mari
P.216



GAZELLE
by Park Associati
P.218



PORTABLE ATELIER
by Philippe Nigro
P.220



TOTTORI
by Kateryna Sokolova
P.226

TAVOLINI/COFFEE TABLES



ANAPO
by Gordon Guillaumier
P.228



CARMINA
by L + R Palomba
P.230



CUGINETTO
by Enzo Mari
P.232



FRATELLO
by Enzo Mari
P.233



PING
by Giuseppe Chigiotti
P.234



SANGAKU
by Elena Salmistraro
P.234



SERENO
by Fredrikson Stallard
P.236



TOTTORI
by Kateryna Sokolova
P.238



ZAGAZIG
by Driade Lab
P.240



WATERFALL
by Fredrikson Stallard
P.242

CONTENITORI/CABINETS



ERCOLE E AFRODITE
by Driade Lab
P.246



HIDALGO
by Driade Lab
P.250



LOVE
by Fabio Novembre
P.254



VENUS
by Fabio Novembre
P.257



ZIQQURAT
by Driade Lab
P.258



ZIQQURAT
by Driade Lab
P.260

LIBRERIE/BOOKSHELVES



TOTEM SHELF
by Big
P.266



VENUS
by Fabio Novembre
P.266



VIRGO
by Xavier Lust
P.267



ZIGZAG
by Konstantin Grcic
P.268

COMPLEMENTI D'ARREDO/FURNISHING



ACATE
by Borek Sipek
P.280



ARCHIPELAGO
by Fredrikson Stallard
P.274



EDAIRD
by Marcelo Burlon
P.276



EGESO
by Bertocco & Locatelli
P.277



ERBALE
by Bortolani, Becchelli, Maffei
P.281



HANAHANA
by Kazuyo Sejima
P.280



MIRO
by Francesco Bolis
P.279



NEMO MINIATURA
by Fabio Novembre
P.282



OSMOND
by Pietro Derossi
P.277



SNIJDER BIRD
by Ed Annink
P.278



TAYLOR BIRD
by Ed Annink
P.278



WELCOME
by Fabio Novembre
P.286



PIU'DIUNO
by Omar Hassan
P.287

SEDIE - POLTRONCINE/CHAIRS - ARMCHAIRS



BO
by Philippe Starck
P.290



CLOVER
by Ron Arad
P.291



LORD YO
by Philippe Starck
P.292



PIP-e
by P. Starck with E.Quitlet
P.294



PIP-e
by Philippe Starck
P.295



SISSI
by L + R Palomba
P.296



SISSI
by L + R Palomba
P.298



SOF SOF
by Enzo Mari
P.300



TOY
by Philippe Starck
P.301

POUF/OTTOMAN



ARCAD3
by Power
P.304



KOISHI
by Naoto Fukasawa
P.305

SGABELLI/STOOLS



TOKYO-POP
by Tokujin Yoshioka
P.307

POLTRONE/ARMCHAIRS



ELISA
by Enzo Mari
P.309



MODESTY VEILED
by Italo Rota
P.309



MT1
by Ron Arad
P.310



MT3
by Ron Arad
P.310



NEMO
by Fabio Novembre
P.312



PLIE'
by L + R Palomba
P.311



ROLY POLY
by Faye Toogood
P.320



TOKYO-POP
by Tokujin Yoshioka
P.323

DIVANI/SOFAS



ELISA
by Enzo Mari
P.325



GRAND PLIE'
by L + R Palomba
P.326



MT2
by Ron Arad
P.327



ROLY POLY
by Faye Toogood
P.328



TOKYO-POP
by Tokujin Yoshioka
P.331



TOKYO-POP
by Tokujin Yoshioka
P.331

TAVOLI / TABLES



APP
by L + R Palomba
P.333



KALIMBA
by Driade Lab
P.334



KISSI KISSI
by Miki Astori
P.336



LORD YI
by Philippe Starck
P.337



TOKYO-POP
by Tokujin Yoshioka
P.339

TAVOLINI / COFFEE TABLE



PIAFFE'
by L + R Palomba
P.340



TOKYO-POP
by Tokujin Yoshioka
P.339

ANAPO

by Gordon Guillaumier



P.194



P.228-229

CUGINO, CUGINETTO

by Enzo Mari



P.196



P.232

ELISA

by Enzo Mari



P.66



P.96

FRATE, FRATELLO

by Enzo Mari



P.216



P.233

LIRICA, LIRICO

by L + R Palomba



P.72

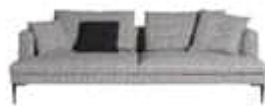

P.126

**LOU EAT, LOU READ,
LOU SPEAK**

by Philippe Starck



P.33



P.33



P.74



P.75

MERIDIANA

by Christophe Pillet



P.34



P.36



P.47

MINGX
by Konstantin Grcic



P.37



P.37



P.49



P.49

MT
by Ron Arad



P.310



P.310



P.327

PIP-e
by Philippe Starck



P.294



P.295

**PLIE', GRAND PLIE',
PIAFFE'**
by L + R Palomba



P.311



P.326



P.340

PORTABLE ATELIER
by Philippe Nigro



P.220



P.50

ROLY POLY
by Faye Toogood



P.320



P.328

**S.MARCO,S.MARCO
LOUNGE**
by M.Thun & A.Rodriguez



P.39



P.40

SISSI

by L + R Palomba



P.296



P.298

TOKYO-POP

by Tokujin Yoshioka



P.323



P.331



P.331



P.307



P.339



P.339

TOTTORI

by Kateryna Sokolova



P.44



P.89



P.164



P.226



P.238

VENUS

by Fabio Novembre



P.266



P.257

VIGILIUS

by M.Thun & A.Rodriguez



P.90



P.172

**SEDIE-POLTRONCINE/
*CHAIRS-ARMCHAIRS***

COSTES
by Philippe Starck
1985

Poltroncina







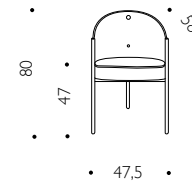





Struttura in tubolare di acciaio verniciato di colore nero, scocca in multistrato curvato con finitura in mogano naturale, ulivo naturale, rovere ebanizzato, ebano naturale. Cuscino di seduta con imbottitura in schiume poliuretaniche con densità differenziate rivestito in pelle con diverse combinazioni e abbinamenti alla scocca in legno. Uso solo interno.

Armchair

Black painted tubular steel structure and curved plywood. Bent plywood shell with finish in natural mahogany, natural olive, ebonised oak, natural ebony. Seat cushion with polyurethane foam padding with differentiated density covered in leather with various combinations to match the wooden shell. Indoor use only.



L. 47,5 P. 58 H. 80; Seduta H. 47; P.L. 10 Kg; V. 0,255 mc
L. 47,5 P. 58 H. 80; Seduta H. 47; P.L. 10 Kg; V. 0,255 mc

Modello Model	Codice Code	Categoria materiale - Descrizione materiale Material category - Material description	Prezzo Retail con Iva Retail price with Vat
<p>Poltroncina con scocca in mogano naturale e cuscino in pelle di colore nero <i>Armchair with natural mahogany shell and black leather cushion</i></p> <div style="display: flex; justify-content: space-between;"> <div style="width: 20%;">  <p>Impiallacciato mogano naturale <i>Natural mahogany veneer</i></p> </div> <div style="width: 20%;"> <p>Codice campione Sample code</p> <p>LEIMO15401</p> </div> <div style="width: 20%;"> <p>Campionario nr. Sample box n.</p> <p>10</p> </div> </div> <div style="display: flex; justify-content: space-between; margin-top: 10px;"> <div style="width: 20%;">  <p>Acciaio verniciato nero Ral 9005 opaco <i>Painted steel matt black Ral 9005</i></p> </div> <div style="width: 20%;">  <p>Cuscino pelle nera <i>Black leather cushion</i></p> </div> </div>	D00404A088A87	Impiallacciato mogano/Acciaio verniciato nero Ral 9005 opaco <i>Mahogany veneer/Painted steel matt black Ral 9005</i>	990,00
<p>Poltroncina con scocca in mogano naturale e cuscino in pelle Niagara color avana <i>Armchair with natural mahogany shell and havana Niagara leather cushion</i></p> <div style="display: flex; justify-content: space-between;"> <div style="width: 20%;">  <p>Impiallacciato mogano naturale <i>Natural mahogany veneer</i></p> </div> <div style="width: 20%;"> <p>Codice campione Sample code</p> <p>LEIMO15401</p> </div> <div style="width: 20%;"> <p>Campionario nr. Sample box n.</p> <p>10</p> </div> </div> <div style="display: flex; justify-content: space-between; margin-top: 10px;"> <div style="width: 20%;">  <p>Acciaio verniciato nero Ral 9005 opaco <i>Painted steel matt black Ral 9005</i></p> </div> <div style="width: 20%;">  <p>Cuscino pelle Niagara color avana 090* <i>090 Havana Niagara leather cushion*</i></p> </div> </div>	D00404A638I02	Impiallacciato mogano/Acciaio verniciato nero Ral 9005 opaco <i>Mahogany veneer/Painted steel matt black Ral 9005</i>	1.150,00
<p>Poltroncina con scocca in mogano naturale e cuscino in pelle Buti colore cuoio <i>Armchair with natural mahogany shell and brown Buti leather cushion</i></p> <div style="display: flex; justify-content: space-between;"> <div style="width: 20%;">  <p>Impiallacciato mogano naturale <i>Natural mahogany veneer</i></p> </div> <div style="width: 20%;"> <p>Codice campione Sample code</p> <p>LEIMO15401</p> </div> <div style="width: 20%;"> <p>Campionario nr. Sample box n.</p> <p>10</p> </div> </div> <div style="display: flex; justify-content: space-between; margin-top: 10px;"> <div style="width: 20%;">  <p>Acciaio verniciato nero Ral 9005 opaco <i>Painted steel matt black Ral 9005</i></p> </div> <div style="width: 20%;">  <p>Cuscino pelle Buti cuoio <i>Brown Buti leather cushion</i></p> </div> </div>	D00404A801I01	Impiallacciato mogano/Acciaio verniciato nero Ral 9005 opaco <i>Mahogany veneer/Anthracite miceralised painted steel</i>	1.300,00
<p>Poltroncina con scocca in ulivo naturale e cuscino in pelle Niagara colore polvere <i>Armchair with natural olive shell and dusty Niagara leather cushion</i></p> <div style="display: flex; justify-content: space-between;"> <div style="width: 20%;">  <p>Impiallacciato di ulivo naturale <i>Natural veneered olive wood</i></p> </div> <div style="width: 20%;"> <p>Codice campione Sample code</p> <p>ND/NA</p> </div> <div style="width: 20%;"> <p>Campionario nr. Sample box n.</p> </div> </div> <div style="display: flex; justify-content: space-between; margin-top: 10px;"> <div style="width: 20%;">  <p>Acciaio verniciato nero Ral 9005 opaco <i>Painted steel matt black Ral 9005</i></p> </div> <div style="width: 20%;">  <p>Cuscino pelle Niagara polvere* <i>Dusty Niagara leather cushion*</i></p> </div> </div>	D00404A806I03	Legno di ulivo/Acciaio verniciato nero Ral 9005 opaco <i>Olive wood/Painted steel matt black Ral 9005</i>	1.450,00

COSTES
by Philippe Starck
1985

Poltroncina



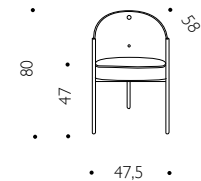

Struttura in tubolare di acciaio verniciato di colore nero, scocca in multistrato curvato con finitura in mogano naturale, ulivo naturale, rovere ebanizzato, ebano naturale. Cuscino di seduta con imbottitura in schiume poliuretatiche con densità differenziate rivestito in pelle con diverse combinazioni e abbinamenti alla scocca in legno. Uso solo interno.

Armchair

Black painted tubular steel structure and curved plywood. Bent plywood shell with finish in natural mahogany, natural olive, ebonised oak, natural ebony. Seat cushion with polyurethane foam padding with differentiated density covered in leather with various combinations to match the wooden shell. Indoor use only.

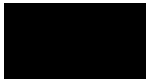

L 47,5 P 58 H 80; Seduta H 47; PL 10 Kg; V 0,255 mc
L 47,5 P 58 H 80; Seduta H 47; PL 10 Kg; V 0,255 mc

Modello Model	Codice Code	Categoria materiale - Descrizione materiale Material category - Material description	Prezzo Retail con Iva Retail price with Vat
<p>Poltroncina con scocca in rovere ebanizzato e cuscino in pelle nera <i>Armchair with ebonized oak shell and black leather cushion</i></p> <div style="display: flex; justify-content: space-between;"> <div style="width: 20%;">  <p>Impiallacciato Rovere Ebanizzato <i>Ebonized oak veneer</i></p> </div> <div style="width: 20%;"> <p>Codice campione Sample code</p> <p>LEIMO154O1</p> </div> <div style="width: 20%;"> <p>Campionario nr. Sample box n.</p> <p>10</p> </div> </div> <div style="display: flex; justify-content: space-between; margin-top: 10px;"> <div style="width: 20%;">  <p>Acciaio verniciato nero Ral 9005 opaco <i>Painted steel matt black Ral 9005</i></p> </div> <div style="width: 20%;"></div> <div style="width: 20%;"></div> </div> <div style="display: flex; justify-content: space-between; margin-top: 10px;"> <div style="width: 20%;">  <p>Cuscino pelle nera <i>Black leather cushion</i></p> </div> <div style="width: 20%;"></div> <div style="width: 20%;"></div> </div>	D00404A089A88	Impiallacciato rovere ebanizzato/Acciaio verniciato nero Ral 9005 opaco <i>Oak veneer/Painted steel matt black Ral 9005</i>	990,00
<p>Poltroncina con scocca in rovere ebanizzato e cuscino in pelle Palaia nera <i>Armchair with ebonized oak shell and black Palaia leather cushion</i></p> <div style="display: flex; justify-content: space-between;"> <div style="width: 20%;">  <p>Impiallacciato Rovere Ebanizzato <i>Ebonized oak veneer</i></p> </div> <div style="width: 20%;"> <p>Codice campione Sample code</p> <p>LEIMO096O1</p> </div> <div style="width: 20%;"> <p>Campionario nr. Sample box n.</p> <p>10</p> </div> </div> <div style="display: flex; justify-content: space-between; margin-top: 10px;"> <div style="width: 20%;">  <p>Acciaio verniciato nero Ral 9005 opaco <i>Painted steel matt black Ral 9005</i></p> </div> <div style="width: 20%;"></div> <div style="width: 20%;"></div> </div> <div style="display: flex; justify-content: space-between; margin-top: 10px;"> <div style="width: 20%;">  <p>Cuscino pelle Palaia nera <i>Black Palaia leather cushion</i></p> </div> <div style="width: 20%;"></div> <div style="width: 20%;"></div> </div>	D00404A807A88	Impiallacciato rovere ebanizzato/Acciaio verniciato nero Ral 9005 opaco <i>Oak veneer/Painted steel matt black Ral 9005</i>	1.350,00

 Disponibile la versione ignifuga BS 5852 Domestic con maggiorazione del 10% solo per tessuti e pelli contrassegnati con *. Uso solo interno.
Tessuto Cliente consentito, si prega di fare riferimento al nostro servizio clienti.
*Available the flame retardant version BS 5852 Domestic with 10% surcharge only for fabrics and leathers marked with *. Indoor use only.*
COM and COL allowed, please refer to our Customer Service.

COSTES
by Philippe Starck
1985

Poltroncina







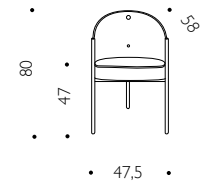





Struttura in tubolare di acciaio verniciato di colore nero, scocca in multistrato curvato con finitura in mogano naturale, ulivo naturale, rovere ebanizzato, ebano naturale. Cuscino di seduta con imbottitura in schiume poliuretaniche con densità differenziate rivestito in pelle con diverse combinazioni e abbinamenti alla scocca in legno.
Uso solo interno.

Armchair

Black painted tubular steel structure and curved plywood. Bent plywood shell with finish in natural mahogany, natural olive, ebonised oak, natural ebony. Seat cushion with polyurethane foam padding with differentiated density covered in leather with various combinations to match the wooden shell. Indoor use only.



L. 47,5 P. 58 H. 80; Seduta H. 47; P.L. 10 Kg; V. 0,255 mc
L. 47,5 P. 58 H. 80; Seduta H. 47; P.L. 10 Kg; V. 0,255 mc

Modello Model	Codice Code	Categoria materiale - Descrizione materiale Material category - Material description	Prezzo Retail con Iva Retail price with Vat
Poltroncina con scocca in ebano naturale e cuscino in pelle nera <i>Armchair with natural ebony shell and black leather cushion</i>	D00404A090A87	Impiallacciato ebano naturale/Acciaio verniciato nero Ral 9005 opaco <i>Veneered natural ebony/Painted steel matt black Ral 9005</i>	1.120,00
 Impiallacciato ebano naturale <i>Veneered natural ebony</i>	Codice campione <i>Sample code</i>	Campionario nr. <i>Sample box n.</i>	
	LEIWE154O1	10	
 Acciaio verniciato nero Ral 9005 opaco <i>Painted steel matt black Ral 9005</i>			
 Cuscino pelle nera <i>Black leather cushion</i>			
Poltroncina con scocca in ebano naturale e cuscino in pelle Niagara colore avana <i>Armchair with natural ebony shell and havana Niagara leather cushion</i>	D00404A640I02	Impiallacciato ebano naturale/Acciaio verniciato nero Ral 9005 opaco <i>Veneered natural ebony/Painted steel matt black Ral 9005</i>	1.250,00
 Impiallacciato ebano naturale <i>Veneered natural ebony</i>	Codice campione <i>Sample code</i>	Campionario nr. <i>Sample box n.</i>	
	LEIWE154O1	10	
 Acciaio verniciato nero Ral 9005 opaco <i>Painted steel matt black Ral 9005</i>			
 Cuscino pelle Niagara color avana 090* <i>090 Havana Niagara leather cushion*</i>			
Poltroncina con scocca in ebano naturale e cuscino in pelle Buti cuoio <i>Armchair with natural ebony shell and brown Buti leather cushion</i>	D00404A802I01	Impiallacciato ebano naturale/Acciaio verniciato nero Ral 9005 opaco <i>Veneered natural ebony/Painted steel matt black Ral 9005</i>	1.450,00
 Impiallacciato ebano naturale <i>Veneered natural ebony</i>	Codice campione <i>Sample code</i>	Campionario nr. <i>Sample box n.</i>	
	LEIWE154O1	10	
 Acciaio verniciato nero Ral 9005 opaco <i>Painted steel matt black Ral 9005</i>			
 Cuscino pelle Buti cuoio <i>Brown Buti leather cushion</i>			
Poltroncina con scocca in ebano naturale e cuscino in pelle Palaia nero <i>Armchair with natural ebony shell and black Palaia leather cushion</i>	D00404A804A87	Impiallacciato ebano naturale/Acciaio verniciato nero Ral 9005 opaco <i>Veneered natural ebony/Painted steel matt black Ral 9005</i>	1.450,00
 Impiallacciato ebano naturale <i>Veneered natural ebony</i>	Codice campione <i>Sample code</i>	Campionario nr. <i>Sample box n.</i>	
	LEIWE154O1	10	
 Acciaio verniciato nero Ral 9005 opaco <i>Painted steel matt black Ral 9005</i>			
 Cuscino pelle Palaia nero <i>Black Palaia leather cushion</i>			

COSTES
by Philippe Starck,
2018

Poltroncina

Struttura in tubolare di acciaio satinato fine verniciata nel colore titanio utilizzando prodotti nanotecnologici a base di leghe metalliche e ceramica. Scocca in multistrato curvato imbottito con gomma in schiuma poliuretanic. Rivestimento di cuscino e schienale in pelle non sfoderabile. Uso solo interno.

Armchair

Tubular frame in fine satin steel painted in titanium color using nanotechnological products based on metal alloys and ceramics. Shell in curved plywood padded with polyurethane foam rubber. Cushion cover and back in fixed leather. Indoor use only.

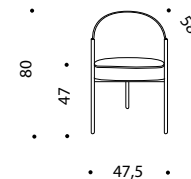

L. 47,5 P. 58 H. 80; Seduta H. 47; P.L. 11,5 Kg; V. 0,255 mc
W. 47,5 D. 58 H. 80; Seat H. 47; G.W. 11,5 Kg; V. 0,255 cbm

Modello Model	Codice Code	Categoria materiale - Descrizione materiale Material category - Material description	Prezzo Retail con Iva Retail price with Vat
	D0404A148	Cat.P Pelle Niagara/Acciaio verniciato* Cat.P Leather Niagara/Polished steel*	2.190,00
	D0404A147	Cat.O Pelle Rio/Acciaio verniciato* Cat.O Leather Rio/Polished steel*	2.240,00
	D0404A152	Cat.ZA Pelle Purus/Acciaio verniciato* Cat.ZA Leather Purus/Polished steel*	2.380,00
	D0404A149	Cat.ZC Pelle Churchill/Acciaio verniciato* Cat.ZC Leather Churchill/Polished steel*	2.590,00

PER LA SCELTA DEI TESSUTI E PELLI CONSULTARE IL LIBRO "ABBINAMENTO TESSUTI-PELLI/MATERIALI"

FOR THE CHOICE OF FABRICS AND LEATHERS, SEE BOOK "MATCHING FABRICS-LEATHERS/MATERIALS"



Acciaio verniciato Titanio
Painted steel Titanium

Codice campione
Sample code
VER11701

Campionario nr.
Sample box n.
7

Disponibile la versione ignifuga BS 5852 Domestic con maggiorazione del 10% solo per tessuti e pelli contrassegnati con *. Uso solo interno.
Tessuto Cliente consentito, si prega di fare riferimento al nostro servizio clienti.
Available the flame retardant version BS 5852 Domestic with 10% surcharge only for fabrics and leathers marked with *. Indoor use only.
COM and COL allowed, please refer to our Customer Service.

PRATFALL
by Philippe Starck
1982 (2023)

Poltrona

Poltrona con struttura in tubolare di acciaio verniciato a polvere poliestere nel colore grigio antracite micallizzato, scocca in multistrato curvato con finitura in mogano naturale, ulivo naturale, rovere ebanizzato, ebano naturale o scocca in multistrato curvato laccato nero a poro chiuso. Cuscino di seduta con imbottitura in schiume poliuretatiche con densità differenziate rivestito in pelle con diverse combinazioni e abbinamenti alla scocca in legno.







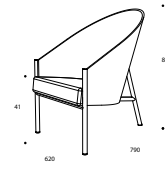





Usa solo interno.

Armchair

Armchair with tubular steel frame painted with polyester powder in the colour mica anthracite grey, bent plywood shell with finish in natural mahogany, natural olive, ebonised oak, natural ebony or shell in curved plywood lacquered black closed pore. Seat cushion with polyurethane foam padding with differentiated density covered in leather with various combinations to match the wooden shell. Indoor use only.



L. 62 P. 74,5 H. 87,5; seduta H. 41; P.L. 17 Kg. V. 0,43 mc
W. 62 D. 74,5 H. 87,5; seat H. 41; G.W. 17 Kg. V. 0,43 cbm

Modello Model	Codice Code	Categoria materiale - Descrizione materiale Material category - Material description	Prezzo Retail con Iva Retail price with Vat
Poltrona con scocca in mogano naturale e cuscino in pelle nera <i>Armchair with natural mahogany shell and black leather cushion</i>	D00438A088G95	Impiallacciato mogano/Acciaio vern. antracite micallizzato <i>Mahogany veneer/Anthracite miceralised painted steel</i>	1.690,00
 Impiallacciato mogano naturale <i>Natural mahogany veneer</i>	Codice campione Sample code	Campionario nr. Sample box n.	
	LEIMO154O1	10	
 Acciaio vern. antracite micallizzato <i>Anthracite miceralised painted steel</i>			
 Cuscino pelle nera <i>Black leather cushion</i>			
Poltrona con scocca in mogano naturale e cuscino in pelle Niagara color avana <i>Armchair with natural mahogany shell and havana Niagara leather cushion</i>	D00438A638G94	Impiallacciato mogano/Acciaio vern. antracite micallizzato <i>Mahogany veneer/Anthracite miceralised painted steel</i>	1.710,00
 Impiallacciato mogano naturale <i>Natural mahogany veneer</i>	Codice campione Sample code	Campionario nr. Sample box n.	
	LEIMO154O1	10	
 Acciaio vern. antracite micallizzato <i>Anthracite miceralised painted steel</i>			
 Cuscino pelle Niagara color avana 090* <i>090 Havana Niagara leather cushion*</i>			
Poltrona con scocca in mogano naturale e cuscino in pelle Buti colore cuoio <i>Armchair with natural mahogany shell and brown Buti leather cushion</i>	D00438A801H98	Impiallacciato mogano/Acciaio vern. antracite micallizzato <i>Mahogany veneer/Anthracite miceralised painted steel</i>	2.050,00
 Impiallacciato mogano naturale <i>Natural mahogany veneer</i>	Codice campione Sample code	Campionario nr. Sample box n.	
	LEIMO154O1	10	
 Acciaio vern. antracite micallizzato <i>Anthracite miceralised painted steel</i>			
 Cuscino pelle Buti cuoio <i>Brown Buti leather cushion</i>			
Poltrona con scocca in ulivo naturale e cuscino in pelle Niagara colore polvere <i>Armchair with natural olive shell and dusty Niagara leather cushion</i>	D00438A806G92	Legno di ulivo/Acciaio vern. antracite micallizzato <i>Olive wood/Anthracite miceralised painted steel</i>	2.150,00
 Impiallacciato di ulivo naturale <i>Natural veneered olive wood</i>	Codice campione Sample code	Campionario nr. Sample box n.	
	ND/NA		
 Acciaio vern. antracite micallizzato <i>Anthracite miceralised painted steel</i>			
 Cuscino pelle Niagara polvere* <i>Dusty Niagara leather cushion*</i>			

PRATFALL
by Philippe Starck
1982 (2023)

Poltrona

Poltrona con struttura in tubolare di acciaio verniciato a polvere poliestere nel colore grigio antracite micalizzato, scocca in multistrato curvato con finitu a in mogano naturale, ulivo naturale, rovere ebanizzato, ebano naturale o scocca in multistrato curvato laccato nero a poro chiuso. Cuscino di seduta con imbottitura in schiume poliuretaniche con densità differenziata rivestito in pelle con diverse combinazioni e abbinamenti alla scocca in legno.





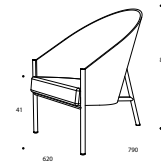

Usò solo interno.

Armchair

Armchair with tubular steel frame painted with polyester powder in the colour mica anthracite grey, bent plywood shell with finish in natural mahogany, natural olive, ebonised oak, natural ebony or shell in curved plywood lacquered black closed pore. Seat cushion with polyurethane foam padding with differentiated density covered in leather with various combinations to match the wooden shell. Indoor use only.



L. 62 P. 74,5 H. 87,5; seduta H. 41 PL. 17 Kg. V. 0,43 mc
W. 62 D. 74,5 H. 87,5; seat H. 41; G.W. 17 Kg. V. 0,43 cbm

Modello Model	Codice Code	Categoria materiale - Descrizione materiale Material category - Material description	Prezzo Retail con Iva Retail price with Vat
<p>Poltrona con scocca in rovere ebanizzato e cuscino in pelle nera Armchair with ebonized oak shell and black leather cushion</p> <div style="display: flex; justify-content: space-between;"> <div style="width: 20%;">  <p>Impiallacciato Rovere Ebanizzato Ebonized oak veneer</p> </div> <div style="width: 20%;"> <p>Codice campione Sample code</p> <p>LEIMO154O1</p> </div> <div style="width: 20%;"> <p>Campionario nr. Sample box n.</p> <p>10</p> </div> </div> <div style="display: flex; justify-content: space-between; margin-top: 10px;"> <div style="width: 20%;">  <p>Acciaio vern.antracite micalizzato Anthracite miceralised painted steel</p> </div> <div style="width: 20%;">  <p>Cuscino pelle nera Black leather cushion</p> </div> </div>	D00438A089G96	Impiallacciato rovere ebanizzato/Acciaio vern.antracite micalizzato Oak veneer/Anthracite miceralised painted steel	1.690,00
<p>Poltrona con scocca in rovere ebanizzato e cuscino in pelle Palaia nera Armchair with ebonized oak shell and black Palaia leather cushion</p> <div style="display: flex; justify-content: space-between;"> <div style="width: 20%;">  <p>Impiallacciato Rovere Ebanizzato Ebonized oak veneer</p> </div> <div style="width: 20%;"> <p>Codice campione Sample code</p> <p>LEIMO096O1</p> </div> <div style="width: 20%;"> <p>Campionario nr. Sample box n.</p> <p>10</p> </div> </div> <div style="display: flex; justify-content: space-between; margin-top: 10px;"> <div style="width: 20%;">  <p>Acciaio vern.antracite micalizzato Anthracite miceralised painted steel</p> </div> <div style="width: 20%;">  <p>Cuscino pelle Palaia nera Black Palaia leather cushion</p> </div> </div>	D00438A807G96	Impiallacciato rovere ebanizzato/Acciaio vern.antracite micalizzato Oak veneer/Anthracite miceralised painted steel	2.100,00

 Disponibile la versione ignifuga BS 5852 Domestic con maggiorazione del 10% solo per tessuti e pelli contrassegnati con *. Usò solo interno.
Tessuto Cliente consentito, si prega di fare riferimento al nostro servizio clienti.
Available the flame retardant version BS 5852 Domestic with 10% surcharge only for fabrics and leathers marked with *. Indoor use only.
COM and COL allowed, please refer to our Customer Service.

PRATFALL
by Philippe Starck
1982 (2023)

Poltrona

Poltrona con struttura in tubolare di acciaio verniciato a polvere poliestere nel colore grigio antracite micallizzato, scocca in multistrato curvato con finitura in mogano naturale, ulivo naturale, rovere ebanizzato, ebano naturale o scocca in multistrato curvato laccato nero a poro chiuso. Cuscino di seduta con imbottitura in schiume poliuretaniche con densità differenziate rivestito in pelle con diverse combinazioni e abbinamenti alla scocca in legno.







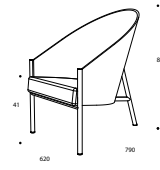





Usa solo interno.

Armchair

Armchair with tubular steel frame painted with polyester powder in the colour mica anthracite grey, bent plywood shell with finish in natural mahogany, natural olive, ebonised oak, natural ebony or shell in curved plywood lacquered black closed pore. Seat cushion with polyurethane foam padding with differentiated density covered in leather with various combinations to match the wooden shell. Indoor use only.



L. 62 P. 74,5 H. 87,5; seduta H. 41 P.L. 17 Kg. V. 0,43 mc
W. 62 D. 74,5 H. 87,5; seat H. 41; G.W. 17 Kg. V. 0,43 cbm

Modello Model	Codice Code	Categoria materiale - Descrizione materiale Material category - Material description	Prezzo Retail con Iva Retail price with Vat
Poltrona con scocca in ebano naturale e cuscino in pelle nera <i>Armchair with natural ebony shell and black leather cushion</i>	D00438A090G95	Impiallacciato ebano naturale/Acciaio vern. antracite micallizzato <i>Veneered natural ebony/Anthracite miceralised painted steel</i>	1.750,00
 Impiallacciato ebano naturale <i>Veneered natural ebony</i>	Codice campione <i>Sample code</i>	Campionario nr. <i>Sample box n.</i>	
	LEIWE154O1	10	
 Acciaio vern. antracite micallizzato <i>Anthracite miceralised painted steel</i>			
 Cuscino pelle nera <i>Black leather cushion</i>			
Poltrona con scocca in ebano naturale e cuscino in pelle Niagara colore avana <i>Armchair with natural ebony shell and havana Niagara leather cushion</i>	D00438A640G94	Impiallacciato ebano naturale/Acciaio vern. antracite micallizzato <i>Veneered natural ebony/Anthracite miceralised painted steel</i>	1.850,00
 Impiallacciato ebano naturale <i>Veneered natural ebony</i>	Codice campione <i>Sample code</i>	Campionario nr. <i>Sample box n.</i>	
	LEIWE154O1	10	
 Acciaio vern. antracite micallizzato <i>Anthracite miceralised painted steel</i>			
 Cuscino pelle Niagara colore avana 090* <i>090 Havana Niagara leather cushion*</i>			
Poltrona con scocca in ebano naturale e cuscino in pelle Nuti colore cuoio <i>Armchair with natural ebony shell and brown Buti leather cushion</i>	D00438A802H98	Impiallacciato ebano naturale/Acciaio vern. antracite micallizzato <i>Veneered natural ebony/Anthracite miceralised painted steel</i>	2.150,00
 Impiallacciato ebano naturale <i>Veneered natural ebony</i>	Codice campione <i>Sample code</i>	Campionario nr. <i>Sample box n.</i>	
	LEIWE154O1	10	
 Acciaio vern. antracite micallizzato <i>Anthracite miceralised painted steel</i>			
 Cuscino pelle Buti colore cuoio <i>Brown Buti leather cushion</i>			
Poltrona con scocca in ebano naturale e cuscino in pelle Palaia nero <i>Armchair with natural ebony shell and black Palaia leather cushion</i>	D00438A804G95	Impiallacciato ebano naturale/Acciaio vern. antracite micallizzato <i>Veneered natural ebony/Anthracite miceralised painted steel</i>	2.150,00
 Impiallacciato ebano naturale <i>Veneered natural ebony</i>	Codice campione <i>Sample code</i>	Campionario nr. <i>Sample box n.</i>	
	LEIWE154O1	10	
 Acciaio vern. antracite micallizzato <i>Anthracite miceralised painted steel</i>			
 Cuscino pelle Palaia nero <i>Black Palaia leather cushion</i>			

PRATFALL
by Philippe Starck
1982 (2023)

Poltrona

Poltrona con struttura in tubolare di acciaio verniciato a polvere poliestere con scocca in multistrato curvato laccato nero a poro chiuso. Cuscino di seduta con imbottitura in schiume poliuretaniche con densità differenziate rivestito in pelle nera. Uso solo interno.

Armchair

Armchair with tubular steel frame painted with polyester powder in the colour mica anthracite grey, shell in curved plywood lacquered black closed pore. Seat cushion with polyurethane foam padding with differentiated density covered in black leather. Indoor use only.

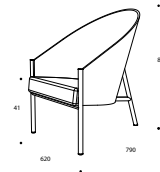

L. 62 P. 74,5 H. 87,5; seduta H. 41 P.L. 17Kg, V. 0,43mc
W. 62 D. 74,5 H. 87,5; seat H. 41; G.W. 17Kg, V. 0,43cbm

Modello Model	Codice Code	Categoria materiale - Descrizione materiale Material category - Material description	Prezzo Retail con Iva Retail price with Vat												
<p>Poltrona con scocca in legno curvato laccato nero a poro chiuso e cuscino in pelle nera <i>Armchair curved plywood lacquered black closed pore and black leather cushion</i></p> <table border="0" data-bbox="65 567 857 829"> <tr> <td data-bbox="65 567 218 644"></td> <td data-bbox="218 567 509 644">Laccato nero a poro chiuso <i>Black lacquered closed pore</i></td> <td data-bbox="509 567 673 644">Codice campione <i>Sample code</i> ND/NA</td> <td data-bbox="673 567 857 644">Campionario nr. <i>Sample box n.</i></td> </tr> <tr> <td data-bbox="65 655 218 731"></td> <td data-bbox="218 655 509 731">Acciaio vern.antracite micalizzato <i>Anthracite miceralised painted steel</i></td> <td data-bbox="509 655 673 731">ND/NA</td> <td></td> </tr> <tr> <td data-bbox="65 742 218 829"></td> <td data-bbox="218 742 509 829">Cuscino pelle nera <i>Black leather cushion</i></td> <td></td> <td></td> </tr> </table>		Laccato nero a poro chiuso <i>Black lacquered closed pore</i>	Codice campione <i>Sample code</i> ND/NA	Campionario nr. <i>Sample box n.</i>		Acciaio vern.antracite micalizzato <i>Anthracite miceralised painted steel</i>	ND/NA			Cuscino pelle nera <i>Black leather cushion</i>			D00438A620G91	Multistrato curvato laccato nero/Acciaio vern.antracite micalizzato <i>Curved plywood lacquered blackAnthracite miceralised painted steel</i>	1.650,00
	Laccato nero a poro chiuso <i>Black lacquered closed pore</i>	Codice campione <i>Sample code</i> ND/NA	Campionario nr. <i>Sample box n.</i>												
	Acciaio vern.antracite micalizzato <i>Anthracite miceralised painted steel</i>	ND/NA													
	Cuscino pelle nera <i>Black leather cushion</i>														

 Disponibile la versione ignifuga BS 5852 Domestic con maggiorazione del 10% solo per tessuti e pelli contrassegnati con *. Uso solo interno.
Tessuto Cliente consentito, si prega di fare riferimento al nostro servizio clienti.
*Available the flame retardant version BS 5852 Domestic with 10% surcharge only for fabrics and leathers marked with *. Indoor use only.*
COM and COL allowed, please refer to our Customer Service.

LA FRANCESCA
by Lievore, Altherr,
Molina 2016

Sedia

Gambe in legno massello di frassino ebanizzato o frassino naturale. Scocca in poliuretano Baydur®. Imbottitura interna in PU flessibile. Rivestimento fisso in tessuto o pelle. E' possibile realizzare la parte interna ed esterna in due diverse categorie di tessuti e pelli; il prezzo finale da considerare è quello della categoria superiore tra quelle scelte. Uso solo interno.

Chair

Legs in ebonized or natural solid ash wood, Baydur polyurethane seat. Inside padding in flexible polyurethane. Fixed leather or fabric cover. It is possible to supply the inside and the outside part in two different categories of fabrics; the total price should be considered the one in the higher category between the chosen ones. Indoor use only.



L. 52 P. 54 H. 83; Seduta H. 45; P.L. 10,25 Kg; V. 0,266 mc
W. 52 D. 54 H. 83; Seat H. 45; G.W. 10,25 Kg; V. 0,266 cbm

Modello Model	Codice Code	Categoria materiale - Descrizione materiale Material category - Material description	Prezzo Retail con Iva Retail price with Vat
	D30001A720	Cat.A Tessuto Cotone Bonifacio/Frassino Cat.A Fabric Cotton Bonifacio/Ash	810,00
	D30001A738	Cat.A misto Poliestere, Acrilico, Cotone Petra/Frassino Cat.A mixed Polyester, Acrylic, Cotton Petra/Ash	
	D30001A747	Cat.A misto Poliestere, Acrilico, Cotone Damasco/Frassino Cat.A mixed Polyester, Acrylic, Cotton Damasco/Ash	
	D30001A756	Cat.B misto Poliestere, Acrilico, Cotone Berlino/Frassino Cat.B mixed Polyester, Acrylic, Cotton Berlino/Ash	890,00
	D30001A765	Cat.B Poliestere Jakarta/Frassino Cat.B Polyester Jakarta/Ash	
	D30001A061	Cat.C Velluto Laira/Frassino Cat.C Velvet Laira/Ash	920,00
	D30001A065	Cat.C Misto Lino Lisbona/Frassino Cat.C Linen Mix Lisbona/Ash	
	D30001A810	Cat.E Lana Divina Melange Kvadrat/Frassino Cat.E Wool Divina Melange Kvadrat/Ash	1.100,00
	D30001A079	Cat.P Pelle Niagara/Frassino Cat.P Leather Niagara/Ash	1.050,00
	D30001A078	Cat.O Pelle Rio/Frassino Cat.O Leather Rio/Ash	1.150,00
	D30001A081	Cat.ZME Pelle Amur/Frassino Cat.ZME Leather Amur/Ash	1.200,00
	D30001A083	Cat.ZA Pelle Purus/Frassino Cat.ZA Leather Purus/Ash	1.250,00
D30001A080	Cat.ZC Pelle Churchill/Frassino Cat.ZC Leather Churchill/Ash	1.550,00	

PER LA SCELTA DEI TESSUTI E PELLI CONSULTARE IL LIBRO "ABBINAMENTO TESSUTI-PELLI/MATERIALI"

FOR THE CHOICE OF FABRICS AND LEATHERS, SEE BOOK "MATCHING FABRICS-LEATHERS/MATERIALS"



Legno di Frassino naturale
Natural ash wood

Codice campione
Sample code

LEMFR15401

Campionario nr.
Sample box n.

10



Legno di Frassino ebanizzato
Ebonized ash wood

Codice campione
Sample code

LEMFR09601

Campionario nr.
Sample box n.

10

LAGÒ
by Philippe Starck
2005

Sedia

Gambe in alluminio anodizzato e scocca in poliuretano rigido completamente rivestita in cuoio nei colori tortora, marrone bianco o nero. Minimo d'acquisto: 6 pezzi per colore. Uso solo interno.

Chair

Anodized aluminum legs and stiff polyurethane shell with dark beige, brown, white or black leather. Minimum purchase: 6 pieces same color. Indoor use only.

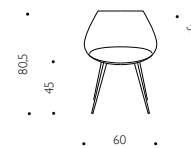

L. 60 P. 57 H. 80,5, Seduta H. 45: P.L. 9,2 Kg V. 0,298 mc
W. 60 D. 57 H. 80,5, Seat H. 45: G.W. 9,2 Kg V. 0,298 cbm



Codice Code	Colore Color	Prezzo Retail con Iva Retail price with Vat
D07251A086531	Bianco White	1.390,00



Cuoio
Leather

Codice campione Sample code	Campionario nr. Sample box n.
ND/NA	



Alluminio anodizzato
Anodized aluminum

ND/NA



Codice Code	Colore Color	Prezzo Retail con Iva Retail price with Vat
D07251A086561	Nero Black	1.390,00



Cuoio
Leather

Codice campione Sample code	Campionario nr. Sample box n.
ND/NA	



Alluminio anodizzato
Anodized aluminum

ND/NA



Codice Code	Colore Color	Prezzo Retail con Iva Retail price with Vat
D07251A086582	Tortora Dark beige	1.390,00



Cuoio
Leather

Codice campione Sample code	Campionario nr. Sample box n.
ND/NA	

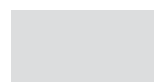

Alluminio anodizzato
Anodized aluminum

ND/NA



Codice Code	Colore Color	Prezzo Retail con Iva Retail price with Vat
D07251A086560	Marrone Brown	1.390,00



Cuoio
Leather

Codice campione Sample code	Campionario nr. Sample box n.
ND/NA	

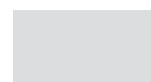

Alluminio anodizzato
Anodized aluminum

ND/NA

LAGÒ
by Philippe Starck
2005

Sedia
Scocca in poliuretano rigido e gambe in alluminio, laccate. Uso solo interno.

Chair
Stiff polyurethane shell and aluminum legs. Indoor use only.

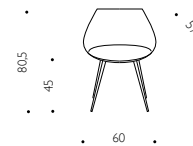

L. 60 P. 57 H. 80,5, Seduta H. 45: P.L. 9,2 Kg V. 0,298 mc
W. 60 D. 57 H. 80,5, Seat H. 45: G.W. 9,2 Kg V. 0,298 cbm



Codice Code	Colore Color	Prezzo Retail con Iva Retail price with Vat
D07251A085002	Bianco Ral 9016 White Ral 9016	860,00

	Codice campione Sample code VER002L2	Campionario nr. Sample box n. 6
--	--	---



Codice Code	Colore Color	Prezzo Retail con Iva Retail price with Vat
D07251A085091	Nero Dic P-1000 lucido Glossy Black Dic P-1000	860,00

	Codice campione Sample code VER091L2	Campionario nr. Sample box n. 6
--	--	---



Codice Code	Colore Color	Prezzo Retail con Iva Retail price with Vat
D07251A085039	Rosso lucido Glossy Red	860,00

	Codice campione Sample code VER039L1	Campionario nr. Sample box n. 6
--	--	---



Codice Code	Colore Color	Prezzo Retail con Iva Retail price with Vat
D07251A085076	Blu oltremare Pantone 654C lucido Glossy ultramarine Blue Pantone 654C	860,00

	Codice campione Sample code VER076L1	Campionario nr. Sample box n. 6
--	--	---



Codice Code	Colore Color	Prezzo Retail con Iva Retail price with Vat
D07251A085033	Arancio Pantone 1505C lucido Glossy orange Pantone 1505C	860,00

	Codice campione Sample code VER033L2	Campionario nr. Sample box n. 6
--	--	---



Codice Code	Colore Color	Prezzo Retail con Iva Retail price with Vat
D07251A085063	Verde RAL D2 1204040 lucido Glossy Green RAL D2 1204040	860,00

	Codice campione Sample code VER063L1	Campionario nr. Sample box n. 6
--	--	---

LAGÒ
by Philippe Starck
2005

Sedia
Scocca in poliuretano rigido e gambe in alluminio, laccate. Uso solo interno.

Sedia
Scocca in poliuretano rigido e gambe in alluminio, laccate. Uso solo interno.

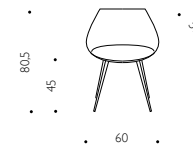

L. 60 P. 57 H. 80,5, Seduta H. 45: P.L. 9,2 Kg V. 0,298 mc
W. 60 D. 57 H. 80,5, Seat H. 45: G.W. 9,2 Kg V. 0,298 cbm



Codice Code	Colore Color	Prezzo Retail con Iva Retail price with Vat
D07251A085060	Azzurro Pantone 5405C Light blue Pantone 5405C	860,00

	Codice campione Sample code	Campionario nr. Sample box n.
	VER060L1	6



Codice Code	Colore Color	Prezzo Retail con Iva Retail price with Vat
D07251A085032	Vinaccia Pantone 221C Burgundy Pantone 221C	860,00

	Codice campione Sample code	Campionario nr. Sample box n.
	VER032L1	6



Codice Code	Colore Color	Prezzo Retail con Iva Retail price with Vat
D07251A085011	Sabbia Pantone Warm gray 4C Greysh beige Pantone Warm gray 4C	860,00

	Codice campione Sample code	Campionario nr. Sample box n.
	VER044L1	6



Codice Code	Colore Color	Prezzo Retail con Iva Retail price with Vat
D07251A085016	Tortora Pantone Warm gray 10C Dark beige Pantone Warm gray 10C	860,00

	Codice campione Sample code	Campionario nr. Sample box n.
	VER044L2	6



Codice Code	Colore Color	Prezzo Retail con Iva Retail price with Vat
D07251A085023	Zafferano Pantone 130C Saffron Pantone 130C	860,00

	Codice campione Sample code	Campionario nr. Sample box n.
	VER023L1	6



Codice Code	Colore Color	Prezzo Retail con Iva Retail price with Vat
D07251A085123	Carta da zucchero Pantone 430C Dark blue Pantone 430C	860,00

	Codice campione Sample code	Campionario nr. Sample box n.
	VER123L1	6

LIBA
by Borek Sipek
1988

Poltroncina

Seduta e schienale in rattan rivestito in midollino di colore naturale, rosso e nero. Gambe anteriori in massello di legno ebanizzato. Uso solo interno.

Armchair

Red and black natural cane seat and back with solid ebonized wooden front legs. Indoor use only.

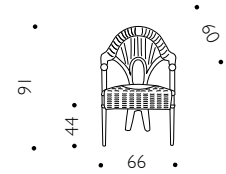

L. 66 P. 60 H. 91; seduta H. 44; P.L. 7,8 Kg; V. 0,5 mc
W. 60 D. 60 H. 91; seat H. 44; G.W. 7,8 Kg; V. 0,5 cbm



Codice
Code

D20224A280138

Colore
Color

Colori vari
Various color

Prezzo Retail con Iva
Retail price with Vat

1.250,00

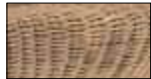

Midollino
Cane

Codice campione
Sample code

Campionario nr.
Sample box n.

LOU EAT
by Philippe Starck
2016

Sedia

Struttura in poliuretano flessibile con inserto metallico. Rivestimento fisso in pelle. E' possibile realizzare la parte interna ed esterna in due diverse categorie di pelli; il prezzo finale da considerare è quello della categoria superiore tra quelle scelte. Il rivestimento esterno puo' essere realizzato nella categoria ZS. Uso solo interno.

Chair

Flexible polyurethane structure with metal insert. Leather fixed cover. It is possible to supply the inside and the outside part in two different categories of leathers; the total price should be considered the one in the higher category between the chosen ones. The outer cover can be supplied in ZS category. Indoor use only.

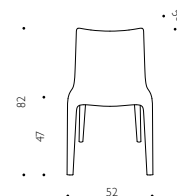

L. 52 P. 54 H. 83; Seduta H. 45; P.L. 10,25 Kg; V. 0,266 mc
W. 52 D. 54 H. 83; Seat H. 45; G.W. 10,25 Kg; V. 0,266 cbm

Modello Model	Codice Code	Categoria materiale - Descrizione materiale Material category - Material description	Prezzo Retail con Iva Retail price with Vat
	D73121A050	Cat.P Pelle Niagara Cat.P Leather Niagara	1.490,00
	D73121A049	Cat.O Pelle Rio Cat.O Leather Rio	1.610,00
	D73121A052	Cat.ZME Pelle Amur Cat.ZME Leather Amur	1.640,00
	D73121A054	Cat.ZA Pelle Purus Cat.ZA Leather Purus	1.740,00
	D73121A051	Cat.ZC Pelle Churchill Cat.ZC Leather Churchill	1.970,00

PER LA SCELTA DEI TESSUTI E PELLI CONSULTARE IL LIBRO "ABBINAMENTO TESSUTI-PELLI/MATERIALI"

FOR THE CHOICE OF FABRICS AND LEATHERS, SEE BOOK "MATCHING FABRICS-LEATHERS/MATERIALS"

LOU EAT
by Philippe Starck
2016

Sedia con braccioli

Struttura in poliuretano flessibile con inserto metallico. Rivestimento fisso in pelle. E' possibile realizzare la parte interna ed esterna in due diverse categorie di pelli; il prezzo finale da considerare è quello della categoria superiore tra quelle scelte. Il rivestimento esterno puo' essere realizzato nella categoria ZS. Uso solo interno.

Armchair

Flexible polyurethane structure with metal insert. Leather fixed cover. It is possible to supply the inside and the outside part in two different categories of leathers; the total price should be considered the one in the higher category between the chosen ones. The outer cover can be supplied in ZS category. Indoor use only.

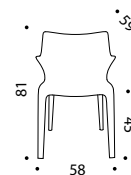

L. 52 P. 54 H. 83; Seduta H. 45; P.L. 10,25 Kg; V. 0,266 mc
W. 52 D. 54 H. 83; Seat H. 45; G.W. 10,25 Kg; V. 0,266 cbm

Modello Model	Codice Code	Categoria materiale - Descrizione materiale Material category - Material description	Prezzo Retail con Iva Retail price with Vat
	D73104A050	Cat.P Pelle Niagara Cat.P Leather Niagara	1.640,00
	D73104A049	Cat.O Pelle Rio Cat.O Leather Rio	1.750,00
	D73104A052	Cat.ZME Pelle Amur Cat.ZME Leather Amur	1.790,00
	D73104A054	Cat.ZA Pelle Purus Cat.ZA Leather Purus	1.890,00
	D73104A051	Cat.ZC Pelle Churchill Cat.ZC Leather Churchill	2.110,00

PER LA SCELTA DEI TESSUTI E PELLI CONSULTARE IL LIBRO "ABBINAMENTO TESSUTI-PELLI/MATERIALI"

FOR THE CHOICE OF FABRICS AND LEATHERS, SEE BOOK "MATCHING FABRICS-LEATHERS/MATERIALS"

MERIDIANA
by Christophe Pillet
2004, 2016

Sedia

Struttura disponibile in: acciaio cromato, in acciaio verniciato di colore nero opaco oppure in legno massello di frassino naturale o tinto carbone. Scocca disponibile in: policarbonato completamente rivestita in pelle mediante tecnologia sottovuoto, policarbonato bianco o nero, policarbonato trasparente: incolore o fumé.

Chair

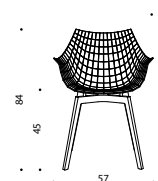

Structure available in: chromed steel, matt black painted steel other in natural ash or charcoal color lacquered ash wood. Shell available in: polycarbonate completely upholstered in leather by means of vacuum technology polycarbonate white or black color, polycarbonate transparent: clear or smoky grey.





L. 57 P. 58 H. 84; seduta H. 45; bracciolo H. 65,5;
PL. 10 Kg; V. 0,33 mc
W. 57 D. 58 H. 84; seat H. 45; armrest H. 65,5;
G.W. 10 Kg; V. 0,33 cbm





Codice Code	Colore Color	Prezzo Retail con Iva Retail price with Vat
D33011A156177		645,00

Codice campione Sample code	Campionario nr. Sample box n.
 Struttura frassino naturale Natural ash wood structure LEMFR154O1	10
 Scocca policarbonato bianco White polycarbonate shell PLA002L1	5



D33011A156207		645,00
---------------	--	--------

 Struttura frassino naturale Natural ash wood structure LEMFR154O1	10
 Scocca policarbonato nero Black polycarbonate shell PLA091L1	5



D33011A156A96		645,00
---------------	--	--------

 Struttura frassino naturale Natural ash wood structure LEMFR154O1	10
 Scocca policarbonato trasparente Transparent polycarbonate shell PLA001L1	5

D33011A156A97		645,00
---------------	--	--------



 Struttura frassino naturale Natural ash wood structure LEMFR154O1	10
 Scocca policarbonato fumé Smoky grey polycarbonate shell PLA056L1	5

Codice Code	Colore Color	Prezzo Retail con Iva Retail price with Vat
D33011A079		1.600,00



Codice campione Sample code	Campionario nr. Sample box n.
 Frassino naturale Natural ash wood LEMFR154O1	10
 Scocca in Pelle Niagara Leather Niagara shell	

PER LA SCELTA DELLA PELLE CONSULTARE IL LIBRO "ABBINAMENTO TESSUTI-PELLI/MATERIALI" FOR THE CHOICE OF LEATHERS, SEE BOOK "MATCHING FABRICS-LEATHERS/MATERIALS"



Codice Code	Colore Color	Prezzo Retail con Iva Retail price with Vat
D33011A156230		645,00

Codice campione Sample code	Campionario nr. Sample box n.
 Struttura frassino tinto carbone Charcoal color lacq.ashwood structure LEMFR096O1	10
 Scocca policarbonato bianco White polycarbonate shell PLA002L1	5



D33011A156267		645,00
---------------	--	--------

 Struttura frassino tinto carbone Charcoal color lacq.ashwood structure LEMFR096O1	10
 Scocca policarbonato nero Black polycarbonate shell PLA091L1	5



D33011A156A98		645,00
---------------	--	--------

 Struttura frassino tinto carbone Charcoal color lacq.ashwood structure LEMFR096O1	10
 Scocca policarbonato trasparente Transparent polycarbonate shell PLA001L1	5

D33011A156A99		645,00
---------------	--	--------

 Struttura frassino tinto carbone Charcoal color lacq.ashwood structure LEMFR096O1	10
 Scocca policarbonato fumé Smoky grey polycarbonate shell PLA056L1	5

Codice Code	Colore Color	Prezzo Retail con Iva Retail price with Vat
D33011A079		1.600,00

Codice campione Sample code	Campionario nr. Sample box n.
 Struttura frassino tinto carbone Charcoal color lacq.ashwood structure LEMFR096O1	10
 Scocca in Pelle Niagara Leather Niagara shell	

PER LA SCELTA DELLA PELLE CONSULTARE IL LIBRO "ABBINAMENTO TESSUTI-PELLI/MATERIALI" FOR THE CHOICE OF LEATHERS, SEE BOOK "MATCHING FABRICS-LEATHERS/MATERIALS"

MERIDIANA
by Christophe Pillet
2004, 2016

Sedia

Struttura disponibile in: acciaio cromato, in acciaio verniciato di colore nero opaco oppure in legno massello di frassino naturale o tinto carbone. Scocca disponibile in: policarbonato completamente rivestita in pelle mediante tecnologia sottovuoto, policarbonato bianco o nero, policarbonato trasparente: incolore o fumé.

Chair

Structure available in: chromed steel, matt black painted steel other in natural ash or charcoal color lacquered ash wood. shell available in: polycarbonate completely upholstered in leather by means of vacuum technology polycarbonate white or black color, polycarbonate transparent: clear or smoky grey.

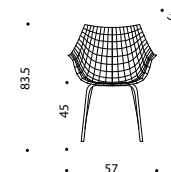

L. 57 P. 58 H. 84; seduta H. 45; bracciolo H. 65,5;
PL. 10 Kg; V. 0,33 mc
W. 57 D. 58 H. 84; seat H. 45; armrest H. 65,5;
G.W. 10 Kg; V. 0,33 cbm



Codice Code	Colore Color	Prezzo Retail con Iva Retail price with Vat
D22311A157B00		385,00

Codice campione Sample code	Campionario nr. Sample box n.
Struttura acciaio cromato Chromed steel structure	ND/NA
Scocca policarbonato bianco White polycarbonate shell	PLA002L1 5

D22311A157B01		385,00
---------------	--	--------

Struttura acciaio cromato Chromed steel structure	ND/NA
Scocca policarbonato nero Black polycarbonate shell	PLA091L1 5

D22311A157B02		385,00
---------------	--	--------

Struttura acciaio cromato Chromed steel structure	ND/NA
Scocca policarbonato trasparente Transparent polycarbonate shell	PLA001L1 5

D22311A157B03		385,00
---------------	--	--------

Struttura acciaio cromato Chromed steel structure	ND/NA
Scocca policarbonato fumé Smoky grey polycarbonate shell	PLA056L1 5

Codice Code	Colore Color	Prezzo Retail con Iva Retail price with Vat
D22311A184		1.370,00

Struttura acciaio cromato Chromed steel structure	ND/NA
Scocca in Pelle Niagara Leather Niagara shell	PER LA SCELTA DELLA PELLE CONSULTARE IL LIBRO "ABBINAMENTO TESSUTI-PELLI/MATERIALI" FOR THE CHOICE OF LEATHERS, SEE BOOK "MATCHING FABRICS-LEATHERS/MATERIALS"

Codice Code	Colore Color	Prezzo Retail con Iva Retail price with Vat
D22311A158596		375,00

Struttura acciaio verniciato nero Black painted steel structure	VER091O3 7
Scocca policarbonato bianco White polycarbonate shell	PLA002L1 5

D22311A158632		375,00
---------------	--	--------

Struttura acciaio verniciato nero Black painted steel structure	VER091O3 7
Scocca policarbonato nero Black polycarbonate shell	PLA091L1 5

D22311A158B04		375,00
---------------	--	--------

Struttura acciaio verniciato nero Black painted steel structure	VER091O3 7
Scocca policarbonato trasparente Transparent polycarbonate shell	PLA001L1 5

D22311A158B05		375,00
---------------	--	--------

Struttura acciaio verniciato nero Black painted steel structure	VER091O3 7
Scocca policarbonato fumé Smoky grey polycarbonate shell	PLA056L1 5

Codice Code	Colore Color	Prezzo Retail con Iva Retail price with Vat
D22311A148		1.370,00

Struttura acciaio verniciato nero Black painted steel structure	VER091O3 7
Scocca in Pelle Niagara Leather Niagara shell	PER LA SCELTA DELLA PELLE CONSULTARE IL LIBRO "ABBINAMENTO TESSUTI-PELLI/MATERIALI" FOR THE CHOICE OF LEATHERS, SEE BOOK "MATCHING FABRICS-LEATHERS/MATERIALS"

MERIDIANA
by Christophe Pillet
2004, 2016

Poltroncina

Struttura disponibile in acciaio cromato o in acciaio verniciato di colore nero opaco. Scocca disponibile in: policarbonato completamente rivestita in pelle mediante tecnologia sottovuoto, policarbonato bianco o nero, policarbonato trasparente: incolore o fumé.

Armchair

Structure available in chromed steel or matt black painted steel. Shell available in: polycarbonate completely upholstered in leather by means of vacuum technology polycarbonate white or black color, polycarbonate transparent: clear or smoky grey.

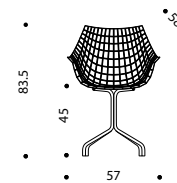

L 57 P 58 H 84; seduta H 45; bracciolo H 65,5;
PL 10 Kg; V 0,33 mc
W 57 D 58 H 84; seat H 45; armrest H 65,5;
G.W. 10 Kg; V 0,33 cbm



Codice Code	Colore Color	Prezzo Retail con Iva Retail price with Vat
D22334A157B00		495,00

Codice campione Sample code	Campionario nr. Sample box n.
Struttura acciaio cromato Chromed steel structure	ND/NA
Scocca policarbonato bianco White polycarbonate shell	PLA002L1 5

D22334A157B01		495,00
---------------	--	--------

Struttura acciaio cromato Chromed steel structure	ND/NA
Scocca policarbonato nero Black polycarbonate shell	PLA091L1 5

D22334A157B02		495,00
---------------	--	--------

Struttura acciaio cromato Chromed steel structure	ND/NA
Scocca policarbonato trasparente Transparent polycarbonate shell	PLA001L1 5

D22334A157B03		495,00
---------------	--	--------

Struttura acciaio cromato Chromed steel structure	ND/NA
Scocca policarbonato fumé Smoky grey polycarbonate shell	PLA056L1 5

Codice Code	Colore Color	Prezzo Retail con Iva Retail price with Vat
D22334A184		1.480,00

Struttura acciaio cromato Chromed steel structure	ND/NA
Scocca in Pelle Niagara Leather Niagara shell	PER LA SCELTA DELLA PELLE CONSULTARE IL LIBRO "ABBINAMENTO TESSUTI-PELLI/MATERIALI" FOR THE CHOICE OF LEATHERS, SEE BOOK "MATCHING FABRICS-LEATHERS/MATERIALS"



Codice Code	Colore Color	Prezzo Retail con Iva Retail price with Vat
D22334A158596		485,00

Codice campione Sample code	Campionario nr. Sample box n.
Struttura acciaio verniciato nero Black painted steel structure	VER091O3 7
Scocca policarbonato bianco White polycarbonate shell	PLA002L1 5

D22334A158632		485,00
---------------	--	--------

Struttura acciaio verniciato nero Black painted steel structure	VER091O3 7
Scocca policarbonato nero Black polycarbonate shell	PLA091L1 5

D22334A158B04		485,00
---------------	--	--------

Struttura acciaio verniciato nero Black painted steel structure	VER091O3 7
Scocca policarbonato trasparente Transparent polycarbonate shell	PLA001L1 5

D22334A158B05		485,00
---------------	--	--------

Struttura acciaio verniciato nero Black painted steel structure	VER091O3 7
Scocca policarbonato fumé Smoky grey polycarbonate shell	PLA056L1 5

Codice Code	Colore Color	Prezzo Retail con Iva Retail price with Vat
D22334A148		1.480,00

Struttura acciaio verniciato nero Black painted steel structure	VER091O3 7
Scocca in Pelle Niagara Leather Niagara shell	PER LA SCELTA DELLA PELLE CONSULTARE IL LIBRO "ABBINAMENTO TESSUTI-PELLI/MATERIALI" FOR THE CHOICE OF LEATHERS, SEE BOOK "MATCHING FABRICS-LEATHERS/MATERIALS"

MINGX
by Konstantin Grcic,
2016

Sedia

Struttura in tubo e lamiera di acciaio stampato verniciato a polvere poliestere nei colori arancio, bronzo e nero. Piedini in abs. Seduta in cuoietto nello stesso colore della struttura. Uso solo interno.

Chair

Structure in printed steel sheet and rod polyester painted in the colors orange, bronze and black. Feet in abs. Leather seat in the same color of the structure. Indoor use only.

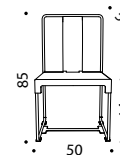

L. 50 P. 51 H. 85; Seduta H. 44; P.L. 12,1 Kg; V. 0,216 mc
W. 50 D 51 H. 85; Seat H. 44; G.W. 12,1 Kg; V. 0,216 cbm

Codice Code	Colore Color	Prezzo Retail con Iva Retail price with Vat
D03001A084033		740,00
	Acciaio verniciato arancio agosto Orange August color painted steel	Codice campione Sample code VER033L1 Campionario nr. Sample box n. 6
D03001A084122		740,00
	Acciaio verniciato Bronzo Bronze painted Steel	Codice campione Sample code VER122L1 Campionario nr. Sample box n. 6
D03001A084091		740,00
	Acciaio verniciato Nero Black painted Steel	Codice campione Sample code VER091L1 Campionario nr. Sample box n. 7



🔥 Disponibile la versione ignifuga BS 5852 Domestic con maggiorazione del 10% solo per tessuti e pelli contrassegnati con *. Uso solo interno.
Tessuto Cliente consentito, si prega di fare riferimento al nostro servizio clienti.
Available the flame retardant version BS 5852 Domestic with 10% surcharge only for fabrics and leathers marked with *. Indoor use only.
COM and COL allowed, please refer to our Customer Service.

MINGX
by Konstantin Grcic,
2016

Poltrona

Struttura in tubo e lamiera di acciaio stampato verniciato a polvere poliestere nei colori arancio, bronzo e nero. Piedini in abs. Seduta in cuoietto nello stesso colore della struttura. Uso solo interno.

Armchair

Structure in printed steel sheet and rod polyester painted in the colors orange, bronze and black. Feet in abs. Leather seat in the same color of the structure. Indoor use only.

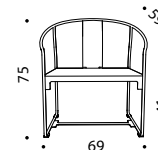

L. 69 P. 59 H. 75; Seduta H. 42; P.L. 15,3 Kg; V. 0,315 mc
W. 69 D 59 H. 75; Seat H. 42; G.W. 15,3 Kg; V. 0,315 cbm

Codice Code	Colore Color	Prezzo Retail con Iva Retail price with Vat
D03408A084033		940,00
	Acciaio verniciato arancio agosto Orange August color painted steel	Codice campione Sample code VER033L1 Campionario nr. Sample box n. 6
D03408A084122		940,00
	Acciaio verniciato Bronzo Bronze painted Steel	Codice campione Sample code VER122L1 Campionario nr. Sample box n. 6
D03408A084091		940,00
	Acciaio verniciato Nero Black painted Steel	Codice campione Sample code VER091L1 Campionario nr. Sample box n. 7



🔥 Disponibile la versione ignifuga BS 5852 Domestic con maggiorazione del 10% solo per tessuti e pelli contrassegnati con *. Uso solo interno.
Tessuto Cliente consentito, si prega di fare riferimento al nostro servizio clienti.
Available the flame retardant version BS 5852 Domestic with 10% surcharge only for fabrics and leathers marked with *. Indoor use only.
COM and COL allowed, please refer to our Customer Service.

MISS LACY
by Philippe Starck,
2007

Sedia

Scocca in fusione di acciaio inox traforato e gambe conifcate in acciaio inox lucidato a specchio. Uso solo interno.

Chair

Patterned shell in stainless steel casting and tubular legs in stainless steel, completely mirror polished. Indoor use only.



L. 58 P. 58 H. 77; seduta H. 44,5; PL. 20 Kg; V. 0,307 mc
W. 58 D. 58 H. 77; seat H. 44,5; GW. 20 Kg; V. 0,307 cbm



Codice
Code
D08301A431A95

Colore
Color
Acciaio
Steel

Prezzo Retail con Iva
Retail price with Vat

1.740,00

Codice campione
Sample code

Campionario nr.
Sample box n.

META95L1

7

Acciaio inox lucidato
Polished stainless Steel

S.MARCO
by Matteo Thun &
Antonio Rodriguez
2007

Sedia

Struttura in legno curvato e gambe in legno di faggio laccato nero. Imbottitura in schiume poliuretaniche e ovatta. Rivestimento fisso in tessuto o pelle. Rivestimento tessuto cliente: quotazione e tempi di consegna da definire e all'atto della richiesta. Uso solo interno.

Chair

Black lacquered beechwood legs and polyurethane foams padded wooden structure with fabric or leather fixed cover. COM or COL cover: pricing and delivery time to be agreed on demand. Indoor use only.

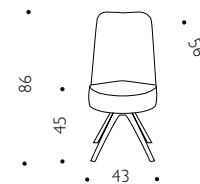



L. 43 P. 56 H. 86; seduta H. 45; P.L. 14 Kg; V. 0,30 mc
W. 43 D. 56 H. 86; seat H. 45; G.W. 14 Kg; V. 0,30 cbm



PER LA SCELTA DEI TESSUTI E PELLI CONSULTARE IL LIBRO "ABBINAMENTO TESSUTI-PELLI/MATERIALI"

FOR THE CHOICE OF FABRICS AND LEATHERS, SEE BOOK "MATCHING FABRICS-LEATHERS/MATERIALS"

 Disponibile la versione ignifuga BS 5852 Domestic con maggiorazione del 10% solo per tessuti e pelli contrassegnati con *. Uso solo interno.
Tessuto Cliente consentito, si prega di fare riferimento al nostro servizio clienti.
Available the flame retardant version BS 5852 Domestic with 10% surcharge only for fabrics and leathers marked with *. Indoor use only.
COM and COL allowed, please refer to our Customer Service.

Modello Model	Codice Code	Categoria materiale - Descrizione materiale Material category - Material description	Prezzo Retail con Iva Retail price with Vat
	D10411A727	Cat.A Cotone Bonifacio/Faggio laccato * Cat.A Cotton Bonifacio/Lacquered beechwood *	1150,00
	D10411A736	Cat.A Poliestere Marsiglia/Faggio laccato Cat.A Polyester Marsiglia/Lacquered beechwood	
	D10411A745	Cat.A misto Poliestere, Arilico, Cotone Petra/Faggio laccato Cat.A mixed Polyester, Acrylic, Cotton Petra/Lacquered beechwood	
	D10411A754	Cat.A misto Poliestere, Arilico, Cotone Damasco/Faggio laccato Cat.A mixed Polyester, Acrylic, Cotton Damasco/Lacquered beechwood	
	D10411A314	Cat.A Ecopelle Colorado/Faggio laccato Cat.A Eco-leather Colorado/Lacquered beechwood	
	D10411A763	Cat.B misto Poliestere, Arilico, Cotone Berlino/Faggio laccato * Cat.B mixed Polyester, Acrylic, Cotton Berlino/Lacquered beechwood *	1200,00
	D10411A772	Cat.B Poliestere Jakarta/Faggio laccato Cat.B Polyester Jakarta/Lacquered beechwood	
	D10411A781	Cat.B Poliestere Ginevra/Faggio laccato Cat.B Polyester Ginevra/Lacquered beechwood	
	D10411A317	Cat.C Velluto Loira/Faggio laccato * Cat.C Velvet Loira/Lacquered beechwood *	1250,00
	D10411A322	Cat.C Misto Lino Lisbona/Faggio laccato Cat.C Linen Mix Lisbona/Lacquered beechwood	
	D10411A790	Cat.C Polipropilene Amburgo/Faggio laccato * Cat.C Polypropylene Amburgo/Lacquered beechwood *	
	D10411A808	Cat.D Lana vergine, Cotone, Poliammide Malmö/Faggio laccato Cat.D virgin Wool, Cotton, Polyamide Malmö/Lacquered beechwood	1350,00
	D10411A817	Cat.E Lana Divina Melange Kvadrat /Faggio laccato * Cat.E Wool Divina Melange Kvadrat/Lacquered beechwood *	1500,00
	D10411A826	Cat.E Cotone Venezia/Faggio laccato Cat.E Cotton Venezia/Lacquered beechwood	
	D10411A335	Cat.P Pelle Niagara/Faggio laccato * Cat.P Leather Niagara/Lacquered beechwood *	1450,00
D10411A334	Cat.O Pelle Rio/Faggio laccato * Cat.O Leather Rio/Lacquered beechwood *	1550,00	
D10411A337	Cat.ZME Pelle Amur/Faggio laccato * Cat.ZME Leather Amur/Lacquered beechwood *	1800,00	
D10411A339	Cat.ZA Pelle Purus/Faggio laccato * Cat.ZA Leather Purus/Lacquered beechwood *	1950,00	
D10411A336	Cat.ZC Pelle Churchill/Faggio laccato * Cat.ZC Leather Churchill/Lacquered beechwood *	2050,00	

Codice campione
Sample code
LEMLA09101

Campionario nr.
Sample box n.
10

S.MARCO LOUNGE

by Matteo Thun &
Antonio Rodriguez
2018

Sedia bassa

Struttura in legno curvato e gambe in legno di faggio laccato nero. Imbottitura in schiume poliuretatiche e ovatta. Rivestimento fisso in tessuto o pelle. Rivestimento tessuto cliente: quotazione e tempi di consegna da definire e all'atto della richiesta. Uso solo interno.

Low chair

Black lacquered beechwood legs and polyurethane foams padded wooden structure with fabric or leather fixed cover. COM or COL cover: pricing and delivery time to be agreed on demand. Indoor use only.

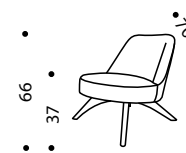

L. 63 P. 70 H. 66; seduta H. 37; PL. 25 Kg; V. 0,55 mc
W. 63 D. 70 H. 66; seat H. 37; G.W. 25 Kg; V. 0,55 cbm



PER LA SCELTA DEI TESSUTI E PELLI CONSULTARE IL LIBRO "ABBINAMENTO TESSUTI-PELLI/MATERIALI"

FOR THE CHOICE OF FABRICS AND LEATHERS, SEE BOOK "MATCHING FABRICS-LEATHERS/MATERIALS"

Modello Model	Codice Code	Categoria materiale - Descrizione materiale Material category - Material description	Prezzo Retail con Iva Retail price with Vat
	D10433A727	Cat.A Cotone Bonifacio/Faggio laccato <i>Cat.A Cotton Bonifacio/Lacquered beechwood</i>	1.400,00
	D10433A736	Cat.A Poliestere Marsiglia/Faggio laccato <i>Cat.A Polyester Marsiglia/Lacquered beechwood</i>	
	D10433A745	Cat.A misto Poliestere, Arilico, Cotone Petra/Faggio laccato <i>Cat.A mixed Polyester, Acrylic, Cotton Petra/Lacquered beechwood</i>	
	D10433A754	Cat.A misto Poliestere, Arilico, Cotone Damasco/Faggio laccato <i>Cat.A mixed Polyester, Acrylic, Cotton Damasco/Lacquered beechwood</i>	
	D10433A314	Cat.A Ecopelle Colorado/Faggio laccato <i>Cat.A Eco-leather Colorado/Lacquered beechwood</i>	
	D10433A763	Cat.B misto Poliestere, Arilico, Cotone Berlino/Faggio laccato <i>Cat.B mixed Polyester, Acrylic, Cotton Berlino/Lacquered beechwood</i>	1.450,00
	D10433A772	Cat.B Poliestere Jakarta/Faggio laccato <i>Cat.B Polyester Jakarta/Lacquered beechwood</i>	
	D10433A781	Cat.B Poliestere Ginevra/Faggio laccato <i>Cat.B Polyester Ginevra/Lacquered beechwood</i>	
	D10433A317	Cat.C Velluto Loira/Faggio laccato <i>Cat.C Velvet Loira/Lacquered beechwood</i>	1.510,00
	D10433A322	Cat.C Misto Lino Lisbona/Faggio laccato <i>Cat.C Linen Mix Lisbona/Lacquered beechwood</i>	
	D10433A790	Cat.C Polipropilene Amburgo/Faggio laccato <i>Cat.C Polypropylene Amburgo/Lacquered beechwood</i>	
	D10433A808	Cat.D Lana vergine, Cotone, Poliammide Malmö/Faggio laccato <i>Cat.D virgin Wool, Cotton, Polyamide Malmö/Lacquered beechwood</i>	1.600,00
	D10433A817	Cat.E Lana Divina Melange Kvadrat /Faggio laccato <i>Cat.E Wool Divina Melange Kvadrat/Lacquered beechwood</i>	1.840,00
	D10433A826	Cat.E Cotone Venezia/Faggio laccato <i>Cat.E Cotton Venezia/Lacquered beechwood</i>	
	D10433A335	Cat.P Pelle Niagara/Faggio laccato <i>Cat.P Leather Niagara/Lacquered beechwood</i>	1.790,00
D10433A334	Cat.O Pelle Rio/Faggio laccato <i>Cat.O Leather Rio/Lacquered beechwood</i>	1.900,00	
D10433A337	Cat.ZME Pelle Amur/Faggio laccato <i>Cat.ZME Leather Amur/Lacquered beechwood</i>	2.100,00	
D10433A339	Cat.ZA Pelle Purus/Faggio laccato <i>Cat.ZA Leather Purus/Lacquered beechwood</i>	2.200,00	
D10433A336	Cat.ZC Pelle Churchill/Faggio laccato <i>Cat.ZC Leather Churchill/Lacquered beechwood</i>	2.300,00	

Codice campione
Sample code
LEMLA09101

Campionario nr.
Sample box n.
10

SOF SOF
by Enzo Mari
1972-2015

Sedia

Struttura in tondino di acciaio verniciato a polveri poliestere colore grigio grafite. Cuscini in schiuma poliuretanic a densità variabile e rivestimento sfoderabile in tessuto cat.A (ad eccezione di Colorado - ecopelle), cat.B, C, D o pelle microforata. Uso solo interno. Riedizione (1972).

Chair

Structure in polyester powder coated steel rod graphite grey. Cushions in polyurethane foam of varying density and removable cover fabric cat. A (except Colorado - eco-leather), B, C, D or micro-perforated leather. Indoor use only, Re-edition (1972)

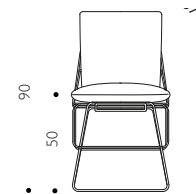

L 46 P. 57 H. 90; seduta H. 50; P.L. 8,6 Kg; V. 0,287 mc
W. 46 D. 57 H. 90; seat H. 50; G.W. 8,6 Kg; V. 0,287 cbm

Modello Model	Codice Code	Categoria materiale - Descrizione materiale Material category - Material description	Prezzo Retail con Iva Retail price with Vat
	D25001A722	Cat.A Cotone Bonifacio/Acciaio verniciato <i>Cat.A Cotton Bonifacio/Painted steel</i>	930,00
	D25001A731	Cat.A Poliestere Marsiglia/Acciaio verniciato <i>Cat.A Polyester Marsiglia/Painted steel</i>	
	D25001A740	Cat.A misto Poliestere, Acrilico, Cotone Petra/Acciaio verniciato <i>Cat.A mixed Polyester, Acrylic, Cotton Petra/Painted steel</i>	
	D25001A749	Cat.A misto Poliestere, Acrilico, Cotone Damasco/Acciaio verniciato <i>Cat.A mixed Polyester, Acrylic, Cotton Damasco/Painted steel</i>	
	D25001A758	Cat.B misto Poliestere, Acrilico, Cotone Berlino/Acciaio verniciato <i>Cat.B mixed Polyester, Acrylic, Cotton Berlino/Painted steel</i>	990,00
	D25001A776	Cat.B Poliestere Ginevra/Acciaio verniciato <i>Cat.B Polyester Ginevra/Painted steel</i>	
	D25001A130	Cat.C Velluto Loira/Acciaio verniciato <i>Cat.C Velvet Loira/Painted steel</i>	1.050,00
	D25001A134	Cat.C Misto Lino Lisbona/Acciaio verniciato <i>Cat.C Linen Mix Lisbona/Painted steel</i>	
	D25001A138	Cat.C Lino Barcellona/Acciaio verniciato <i>Cat.C Linen Barcellona/Painted steel</i>	
	D25001A785	Cat.C Polipropilene Amburgo/Acciaio verniciato <i>Cat.C Polypropylene Amburgo/Painted steel</i>	
	D25001A794	Cat.C misto Poliestere, Acrilico, Cotone, Lana, Viscosa Berna/Acciaio verniciato <i>Cat.C mixed Polyester, Acrylic, Cotton, Wool, Viscose Berna/Painted steel</i>	
	D25001A803	Cat.D Lana vergine, Cotone, Poliammide Malmö/Acciaio verniciato <i>Cat.D virgin Wool, Cotton, Polyamide Malmö/Painted steel</i>	1.120,00
	D25001A812	Cat.E Lana Divina Melange Kvadrat/Acciaio verniciato <i>Cat.E Wool Divina Melange Kvadrat/Painted steel</i>	1.200,00
	D25001A821	Cat.E Cotone Venezia/Acciaio verniciato <i>Cat.E Cotton Venezia/Painted steel</i>	
	D25001A153	Pelle Niagara microforata/Acciaio verniciato <i>Micro-perforated Leather Niagara/Painted steel</i>	1.170,00

PER LA SCELTA DEI TESSUTI E PELLI CONSULTARE IL LIBRO "ABBINAMENTO TESSUTI-PELLI/MATERIALI"

FOR THE CHOICE OF FABRICS AND LEATHERS, SEE BOOK "MATCHING FABRICS-LEATHERS/MATERIALS"



Codice campione
Sample code

Campionario nr.
Sample box n.

ND/NA

SOIREE

by Oscar e Gabriele
Buratti
2018

Sedia

Sedia in poliuretano flessibile a media densità con inserto metallico strutturale. Cinghiatura elastica nella seduta e nello schienale per il massimo comfort. Rivestimento fisso in pelle o sfoderabile in tessuto, cuciture decorative su gambe e schienale, piedini in nylon per l'appoggio a terra. Uso solo interno.

Chair

Chair in flexible medium density polyurethane with structural metal insert and elastic belt in the seat and back for maximum comfort. Fix leather or removable fabric cover, decorative stitching on legs and back and nylon feet. Indoor use only.

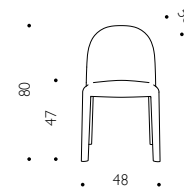

L. 48 P. 56 H. 80,5; seduta H. 47; P.L. 12,5 Kg; V. 0,216 mc
W. 48 D. 56 H. 80,5; seat H. 47; G.W. 12,5 Kg; V. 0,216 cbm

Modello Model	Codice Code	Categoria materiale - Descrizione materiale Material category - Material description	Prezzo Retail con Iva Retail price with Vat
<p>Sedia con cuciture decorative su gambe e schienale</p> <p>Chair with decorative stitching on legs and back</p> 	D73110A700	Cat.A Cotone Bonifacio * Cat.A Cotton Bonifacio *	860,00
	D73110A701	Cat.A Poliestere Marsiglia Cat.A Polyester Marsiglia	
	D73110A702	Cat.A misto Poliestere, Acrilico, Cotone Petra Cat.A mixed Polyester, Acrylic, Cotton Petra	
	D73110A703	Cat.A misto Poliestere, Acrilico, Cotone Damasco Cat.A mixed Polyester, Acrylic, Cotton Damasco	
	D73110A704	Cat.B misto Poliestere, Acrilico, Cotone Berlino * Cat.B mixed Polyester, Acrylic, Cotton Berlino *	960,00
	D73110A705	Cat.B Poliestere, Acrilico, Cotone Jakarta Cat.B Polyester, Acrylic, Cotton Jakarta	
	D73110A706	Cat.B Poliestere Ginevra Cat.B Polyester Ginevra	
	D73110A036	Cat.C Misto Lino Lisbona Cat.C Linen Mix Lisbona	1.000,00
	D73110A040	Cat.C Lino Barcellona * Cat.C Linen Barcellona *	
	D73110A712	Cat.D Lana vergine, Cotone, Poliammide Malmö Cat.D virgin Wool, Cotton, Polyamide Malmö	1.090,00
	D73110A713	Cat.E Lana Divina Melange Kvadrat * Cat.E Wool Divina Melange Kvadrat *	1.150,00
	D73110A050	Cat.P Pelle Niagara * Cat.P Leather Niagara *	1.100,00
	D73110A049	Cat.O Pelle Rio * Cat.O Leather Rio *	1.250,00
D73110A054	Cat.ZA Pelle Purus * Cat.ZA Leather Purus *	1.400,00	
D73110A051	Cat.ZC Pelle Churchill * Cat.ZC Leather Churchill *	1.700,00	

PER LA SCELTA DEI TESSUTI E PELLI CONSULTARE IL LIBRO "ABBINAMENTO TESSUTI-PELLI/MATERIALI"

FOR THE CHOICE OF FABRICS AND LEATHERS, SEE BOOK "MATCHING FABRICS-LEATHERS/MATERIALS"



Disponibile la versione ignifuga BS 5852 Domestic con maggiorazione del 10% solo per tessuti e pelli contrassegnati con *. Uso solo interno.

Tessuto Cliente consentito, si prega di fare riferimento al nostro servizio clienti.

Available the flame retardant version BS 5852 Domestic with 10% surcharge only for fabrics and leathers marked with *. Indoor use only.

COM and COL allowed, please refer to our Customer Service.

SOIREE

by Oscar e Gabriele
Buratti
2018

Sedia

Sedia in poliuretano flessibile a media densità con inserto metallico strutturale. Cinghiatura elastica nella seduta e nello schienale per il massimo comfort. Rivestimento fisso in pelle o sfoderabile in tessuto, piedini in nylon per l'appoggio a terra. Uso solo interno.

Chair

Chair in flexible medium density polyurethane with structural metal insert and elastic belt in the seat and back for maximum comfort. Fix leather or removable fabric cover and nylon feet. Indoor use only.

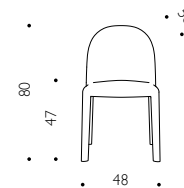

L. 48 P. 56 H. 80,5; seduta H. 47; P.L. 12,5 Kg; V. 0,216 mc
W. 48 D. 56 H. 80,5; seat H. 47; G.W. 12,5 Kg; V. 0,216 cbm

Modello Model	Codice Code	Categoria materiale - Descrizione materiale Material category - Material description	Prezzo Retail con Iva Retail price with Vat
<p>Sedia senza cuciture decorative su gambe e schienale</p> <p>Chair without decorative stitching on legs and back</p> 	D73130AA700	Cat.A Cotone Bonifacio * Cat.A Cotton Bonifacio *	860,00
	D73130AA701	Cat.A Poliestere Marsiglia Cat.A Polyester Marsiglia	
	D73130AA702	Cat.A misto Poliestere, Acrilico, Cotone Petra Cat.A mixed Polyester, Acrylic, Cotton Petra	
	D73130AA703	Cat.A misto Poliestere, Acrilico, Cotone Damasco Cat.A mixed Polyester, Acrylic, Cotton Damasco	
	D73130A704	Cat.B misto Poliestere, Acrilico, Cotone Berlino * Cat.B mixed Polyester, Acrylic, Cotton Berlino *	960,00
	D73130A705	Cat.B Poliestere, Acrilico, Cotone Jakarta Cat.B Polyester, Acrylic, Cotton Jakarta	
	D73130A706	Cat.B Poliestere Ginevra Cat.B Polyester Ginevra	
	D73130A036	Cat.C Misto Lino Lisbona Cat.C Linen Mix Lisbona	1.000,00
	D73130A040	Cat.C Lino Barcellona * Cat.C Linen Barcellona *	
	D73130A712	Cat.D Lana vergine, Cotone, Poliammide Malmö Cat.D virgin Wool, Cotton, Polyamide Malmö	1.090,00
	D73130A713	Cat.E Lana Divina Melange Kvadrat * Cat.E Wool Divina Melange Kvadrat *	1.150,00
	D73130A050	Cat.P Pelle Niagara * Cat.P Leather Niagara *	1.100,00
	D73130A049	Cat.O Pelle Rio * Cat.O Leather Rio *	1.250,00
D73130A054	Cat.ZA Pelle Purus * Cat.ZA Leather Purus *	1.400,00	
D73130A051	Cat.ZC Pelle Churchill * Cat.ZC Leather Churchill *	1.700,00	

PER LA SCELTA DEI TESSUTI E PELLI CONSULTARE IL LIBRO "ABBINAMENTO TESSUTI-PELLI/MATERIALI"

FOR THE CHOICE OF FABRICS AND LEATHERS, SEE BOOK "MATCHING FABRICS-LEATHERS/MATERIALS"



Disponibile la versione ignifuga BS 5852 Domestic con maggiorazione del 10% solo per tessuti e pelli contrassegnati con *. Uso solo interno.

Tessuto Cliente consentito, si prega di fare riferimento al nostro servizio clienti.

Available the flame retardant version BS 5852 Domestic with 10% surcharge only for fabrics and leathers marked with *. Indoor use only.

COM and COL allowed, please refer to our Customer Service.

TOTTORI

by Kateryna Sokolova
2021

Sedia

Struttura in poliuretano flessibile a media densità, piedini in PE per l'appoggio a terra. Il rivestimento è fisso con la possibilità di materiali differenti per le gambe rispetto a quelli di seduta e schienale. Uso solo interno.

Chair

Structure in medium density flexible polyurethane, PE feet for ground support. The cover is fixed with the possibility of different materials for the legs than those of the seat and back. Indoor use only.

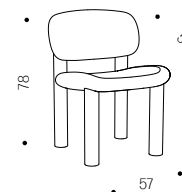

L. 57 P. 57 H. 78; seduta H. 46; P.L. 17 Kg; V. 0,295 mc
W. 57 D. 57 H. 78; seat H. 46; G.W. 17 Kg; V. 0,295 cbm



Modello Model	Codice Code	Categoria materiale - Descrizione materiale Material category - Material description	Prezzo Retail con Iva Retail price with Vat
	DA5631A700	Cat.A Cotone Bonifacio * Cat.A Cotton Bonifacio *	970,00
	DA5631A701	Cat.A Poliestere Marsiglia Cat.A Polyester Marsiglia	
	DA5631A702	Cat.A misto Poliestere, Acrilico, Cotone Petra Cat.A mixed Polyester, Acrylic, Cotton Petra	
	DA5631A703	Cat.A misto Poliestere, Acrilico, Cotone Damasco Cat.A mixed Polyester, Acrylic, Cotton Damasco	
	DA5631A704	Cat.B misto Poliestere, Acrilico, Cotone Berlino * Cat.B mixed Polyester, Acrylic, Cotton Berlino *	1.050,00
	DA5631A705	Cat.B Poliestere Jakarta Cat.B Polyester Jakarta	
	DA5631A706	Cat.B Poliestere Ginevra Cat.B Polyester Ginevra	
	DA5631A036	Cat.C Misto Lino Lisbona Cat.C Linen Mix Lisbona	1.090,00
	DA5631A040	Cat.C Lino Barcellona * Cat.C Linen Barcellona *	
	DA5631A709	Cat.C Polipropilene Amburgo * Cat.C Polypropylene Amburgo *	
	DA5631A710	Cat.C misto Poliestere, Acrilico, Cotone, Lana, Viscosa Berna * Cat.C mixed Polyester, Acrylic, Cotton, Wool, Viscose Berna *	
	DA5631A712	Cat.D Lana vergine, Cotone, Poliammide Malmö Cat.D virgin Wool, Cotton, Polyamide Malmö	1.190,00
DA5631A713	Cat.E Lana Divina Melange Kvadrat * Cat.E Wool Divina Melange Kvadrat *	1.350,00	
DA5631A049	Cat.O Pelle Rio * Cat.O Leather Rio *	1.400,00	
DA5631A052	Cat.ZME Pelle Amur * Cat.ZME Leather Amur *	1.580,00	
DA5631A054	Cat.ZA Pelle Purus * Cat.ZA Leather Purus *	1.600,00	
DA5631A051	Cat.ZC Pelle Churchill * Cat.ZC Leather Churchill *	1.900,00	

PER LA SCELTA DEI TESSUTI E PELLI CONSULTARE IL LIBRO "ABBINAMENTO TESSUTI-PELLI/MATERIALI"

FOR THE CHOICE OF FABRICS AND LEATHERS, SEE BOOK "MATCHING FABRICS-LEATHERS/MATERIALS"

Disponibile la versione ignifuga BS 5852 Domestic con maggiorazione del 10% solo per tessuti e pelli contrassegnati con *. Uso solo interno.
Tessuto Cliente consentito, si prega di fare riferimento al nostro servizio clienti.
Ordine minimo: 4 pezzi.
Available the flame retardant version BS 5852 Domestic with 10% surcharge only for fabrics and leathers marked with *. Indoor use only.
COM and COL allowed, please refer to our Customer Service.
Minimum Order: 4 pcs

WE
by Fabio Novembre
2023

Sedia

Sedia completamente realizzata in massello di frassino con gambe a sezione conica. Sedile con bordi arrotondati e schienale sagomato con la riproduzione del profilo di un volto. Finitura laccata bianca a poro aperto o con tinta all'anilina nel colore nero.

Chair

Chair made entirely of solid ash with conical-section legs. Seat with rounded edges and shaped backrest with the reproduction of the profile of a face. Finished in open-pore white lacquer or with black aniline stain.

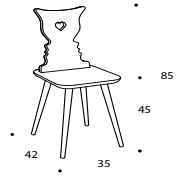

L. 35 P. 41 H. 91; seduta H. 45; P.L. 12 Kg; V. 0,21 mc
W. 35 D. 41 H. 91; seat H. 45; G.W. 12 Kg; V. 0,21 cbm



Codice Code	Colore Color	Prezzo Retail con Iva Retail price with Vat
D91141A471002	Bianco White	350,00
D91141A471091	Nero Black	350,00



Frassino tinto bianco
White ash wood

Codice campione
Sample code
ND/NA

Campionario nr.
Sample box n.



Frassino tinto nero
Ebonized ash wood

LEMFR09601

10

SGABELLI/ *STOOLS*

MERIDIANA
by Christophe Pillet
2004, 2016

Sgabello girevole basso

Struttura disponibile in acciaio cromato o in acciaio verniciato di colore nero opaco. Scocca disponibile in: policarbonato completamente rivestita in pelle mediante tecnologia sottovuoto, policarbonato bianco o nero, policarbonato trasparente: incolore o fumé.

Swivel low stool

Structure available in chromed steel or matt black painted steel. Shell available in: polycarbonate completely upholstered in leather by means of vacuum technology, polycarbonate white or black color, polycarbonate transparent: clear or smoky grey.

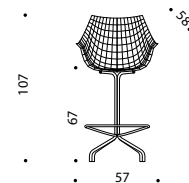



L. 57 P. 58 H. 107; seduta H. 67; bracciolo H. 88; PL. 15 Kg; V. 0,40 mc
W. 57 D. 58 H. 107; seat H. 67; armrest H. 88; G.W. 15 Kg; V. 0,40 cbm



Codice Code	Colore Color	Prezzo Retail con Iva Retail price with Vat
-------------	--------------	--



D19678B157B00

830,00

Codice campione Sample code	Campionario nr. Sample box n.
 Struttura acciaio cromato Chromed steel structure	ND/NA
 Scocca policarbonato bianco White polycarbonate shell	PLA002L1 5



D19678B157B01

830,00

 Struttura acciaio cromato Chromed steel structure	ND/NA
 Scocca policarbonato nero Black polycarbonate shell	PLA091L1 5



D19678B157B02

830,00

 Struttura acciaio cromato Chromed steel structure	ND/NA
 Scocca policarbonato trasparente Transparent polycarbonate shell	PLA001L1 5

D19678B157B03



830,00

 Struttura acciaio cromato Chromed steel structure	ND/NA
 Scocca policarbonato fumé Smoky grey polycarbonate shell	PLA056L1 5

Codice Code	Colore Color	Prezzo Retail con Iva Retail price with Vat
-------------	--------------	--

D19678B184

1.790,00



 Struttura acciaio cromato Chromed steel structure	ND/NA
 Scocca in pelle Niagara Leather Niagara shell	PER LA SCELTA DELLA PELLE CONSULTARE IL LIBRO "ABBINAMENTO TESSUTI-PELLI/MATERIALI" FOR THE CHOICE OF LEATHERS, SEE BOOK "MATCHING FABRICS-LEATHERS/MATERIALS"



Codice Code	Colore Color	Prezzo Retail con Iva Retail price with Vat
-------------	--------------	--



D19678B158596

810,00

 Struttura acciaio verniciato nero Black painted steel structure	VER091O3	7
 Scocca policarbonato bianco White polycarbonate shell	PLA002L1	5



D19678B158632

810,00

 Struttura acciaio verniciato nero Black painted steel structure	VER091O3	7
 Scocca policarbonato nero Black polycarbonate shell	PLA091L1	5



D19678B158B04

810,00

 Struttura acciaio verniciato nero Black painted steel structure	VER091O3	7
 Scocca policarbonato trasparente Transparent polycarbonate shell	PLA001L1	5

D19678B158B05



810,00

 Struttura acciaio verniciato nero Black painted steel structure	VER091O3	7
 Scocca policarbonato fumé Smoky grey polycarbonate shell	PLA056L1	5

Codice Code	Colore Color	Prezzo Retail con Iva Retail price with Vat
-------------	--------------	--

D19678B148

1.790,00

 Struttura acciaio verniciato nero Black painted steel structure	VER091O3	7
 Scocca in pelle Niagara Leather Niagara shell	PER LA SCELTA DELLA PELLE CONSULTARE IL LIBRO "ABBINAMENTO TESSUTI-PELLI/MATERIALI" FOR THE CHOICE OF LEATHERS, SEE BOOK "MATCHING FABRICS-LEATHERS/MATERIALS"	

MILLEPIEDI
by Studio Catoir
2020

Panca

Panca con cinque sedili ed appoggi a terra intervallati, realizzata interamente in massello di frassino nella finitura ebanizzata a "poro aperto". Uso solo interno.

Bench

Bench with five seats and spaced legs, made entirely of solid ash in the "open pore" ebonized finish. Indoor use only.

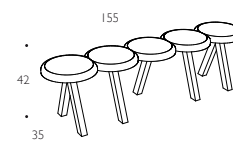

L. 155 P. 35 H. 42; PL. 19 Kg; V. 0,276 mc
W. 155 D. 35 H. 42; G.W. 19 Kg; V. 0,276 cbm



Codice Code	Colore Color	Prezzo Retail con Iva Retail price with Vat
D00134F471002	Bianco Ral 9010 White Ral 9010	1.695,00

Codice Code	Colore Color	Prezzo Retail con Iva Retail price with Vat
D00134F471091	Nero Black	1.695,00

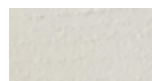

Frassino tinto
Stained ash

Codice campione Sample code	Campionario nr. Sample box n.
LEMFR002O1	10



Frassino tinto
Stained ash

Codice campione Sample code	Campionario nr. Sample box n.
LEMFR091O1	10



Codice Code	Colore Color	Prezzo Retail con Iva Retail price with Vat
D00134F471039	Rosso Red	1.695,00



Frassino tinto
Stained ash

Codice campione Sample code	Campionario nr. Sample box n.
LEMFR039O1	10

MINGX
by Konstantin Grcic,
2016

Sgabelli

Struttura in tubo e lamiera di acciaio stampato verniciato a polvere poliestere nei colori arancio, bronzo e nero. Piedini in abs. Seduta in cuoietto nello stesso colore della struttura. Uso solo interno.

Stools

Structure in printed steel sheet and rod polyester painted in the colors orange, bronze and black. Feet in abs. Leather seat in the same color of the structure. Indoor use only.

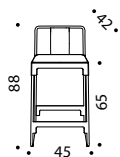

L. 45 P. 42 H. 88; Seduta H. 65; P.L. 11,1 Kg; V. 0,166 mc
W. 45 D 42 H. 88; Seat H. 65; G.W. 11,1 Kg; V. 0,166 cbm

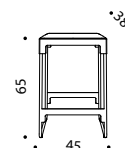







L. 45 P. 38 H. 65; P.L. 9,2 Kg; V. 0,111 mc
W. 45 D 38 H. 65; G.W. 9,2 Kg; V. 0,111 cbm



🔥 Disponibile la versione ignifuga BS 5852 Domestic con maggiorazione del 10% solo per tessuti e pelli contrassegnati con *. Uso solo interno.
Tessuto Cliente consentito, si prega di fare riferimento al nostro servizio clienti.
Available the flame retardant version BS 5852 Domestic with 10% surcharge only for fabrics and leathers marked with *. Indoor use only.
COM and COL allowed, please refer to our Customer Service.

🔥 Disponibile la versione ignifuga BS 5852 Domestic con maggiorazione del 10% solo per tessuti e pelli contrassegnati con *. Uso solo interno.
Tessuto Cliente consentito, si prega di fare riferimento al nostro servizio clienti.
Available the flame retardant version BS 5852 Domestic with 10% surcharge only for fabrics and leathers marked with *. Indoor use only.
COM and COL allowed, please refer to our Customer Service.

Codice Code	Colore Color	Prezzo Retail con Iva Retail price with Vat
D03806B084033		740,00
	Acciaio verniciato arancio agosto Orange August color painted steel	Codice campione Sample code VER033L1
		Campionario nr. Sample box n. 6
D03806B084122		740,00
	Acciaio verniciato Bronzo Bronze painted Steel	Codice campione Sample code VER122L1
		Campionario nr. Sample box n. 6
D03806B084091		740,00
	Acciaio verniciato Nero Black painted Steel	Codice campione Sample code VER091L1
		Campionario nr. Sample box n. 7

Codice Code	Colore Color	Prezzo Retail con Iva Retail price with Vat
D04206B084033		635,00
	Acciaio verniciato arancio agosto Orange August color painted steel	Codice campione Sample code VER033L1
		Campionario nr. Sample box n. 6
D04206B084122		635,00
	Acciaio verniciato Bronzo Bronze painted Steel	Codice campione Sample code VER122L1
		Campionario nr. Sample box n. 6
D04206B084091		635,00
	Acciaio verniciato Nero Black painted Steel	Codice campione Sample code VER091L1
		Campionario nr. Sample box n. 7

**PORTABLE ATELIER
COLLECTION**

by Philippe Nigro
2016

Sgabello



Sgabello con altezza regolabile. Struttura in massello di faggio tinto nero, sedile e vite di regolazione dell'altezza della seduta in massello di rovere. Uso solo interno.

Stool

Stool adjustable in heigh. Black matt painted steel structure. Seat and components in massive oak. Indoor use only.



L. 45 ø seduta 34 H. 45/63
W. 45 ø seat 34 H. 45/63
P.L. 8 Kg; V. 0,140 mc
G.W. 8 Kg; V. 0,140 cbmcbm

Codice Code	Colore Color	Prezzo Retail con Iva Retail price with Vat	Codice campione Sample code	Campionario nr. Sample box n.
		710,00		
D00045B374B20	 Legno di Rovere Oak wood		LEIRO15401	10
	 Faggio laccato nero Black lacquered beech		LEMLA09101	10



PORTABLE ATELIER
by Philippe Nigro
2022

Sgabello

Sgabello con seduta regolabile in altezza mediante pistone a gas con leva, struttura a tre gambe realizzata in massello di faggio tinto nero e seduta in massello di faggio laccato nei colori bianco o nero con finitura opaca. Uso solo interno.

Stool

Stool with height-adjustable seat by means of gas piston with lever, three-leg frame made of solid beech stained black and seat made of solid beech lacquered in white or black with matt finish. Indoor use only.





L. 45 ø seduta 34 H. 45/63
W. 45 ø seat 34 H. 45/63
P.L. 8 Kg; V. 0,140 mc
G.W. 8 Kg; V. 0,140 cbmcbm

D00045B520093	Faggio laccato bianco e nero Black and white lacquered beech	500,00		
---------------	---	--------	--	--



D00045B520632	Faggio laccato nero Black lacquered beech	500,00		
---------------	--	--------	--	--

Codice campione Sample code	Campionario nr. Sample box n.
 Faggio laccato bianco White lacquered beech	ND/NA
 Faggio laccato nero Black lacquered beech	LEMLA09101 10



**POUF/
*OTTOMAN***



ARCAD3
by Pow3r
2022
Pouf/Contentitore

Pouf realizzato in due parti separabili tra loro per consentire l'accesso al contenimento ricavato nella base di appoggio a terra. La seduta è realizzata in poliuretano integrale morbido colorato in massa nelle varianti nero, rosso e blu. La base di appoggio è realizzata in polietilene colorato in massa nelle varianti nero, rosso e blu. Possibilità di aggiungere alla base di appoggio delle ruote pivotanti per spostare facilmente il pouf. Uso interno/esterno.

Pouf/Container

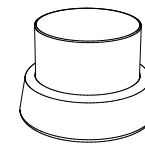
Pouf made in two parts that can be separated from each other to allow access to the storage compartment in the floor-standing base. The seat is made of soft integral polyurethane coloured en masse in black, red and blue. The support base is made of mass-coloured polyethylene in black, red and blue. Possibility of adding pivoting wheels to the support base to move the pouf easily. Indoor/outdoor use.

 Dia. 65/50 H. 45
Dia. 65/50 H. 45

Modello Model	Codice Code	Categoria materiale - Descrizione materiale Material category - Material description	Prezzo Retail con Iva Retail price with Vat
	D91080C650632	Poliuretano/Polietilene nero Black Polyurethane/Polyethylene	590,00
	D91087Z379044	Kit ruote 5pz Wheels kit 5 pcs	40,00
	D91088Z034091	Rivestimento in tessuto Cipro di colore nero Cipro fabric cover in black color	200,00
	D91080C650E17	Poliuretano/Polietilene rosso Red polyurethane/Polyethylene	590,00
	D91087Z379044	Kit ruote 5pz Wheels kit 5 pcs	40,00
	D91088Z034039	Rivestimento in tessuto Cipro di colore rosso Cipro fabric cover in red color	200,00
	D91080C650H02	Poliuretano/Polietilene blu Blue polyurethane/Polyethylene	590,00
	D91087Z379044	Kit ruote 5pz Wheels kit 5 pcs	40,00
	D91088Z034072	Rivestimento in tessuto Cipro di colore blu Cipro fabric cover in blue color	200,00

BLOCCO
by Nanda Vigo
1970-2015

Pouf

Pouf con struttura in legno e imbottitura in schiuma poliuretana a densità variabile. Rivestimento in pelliccia Mongolia nera, in pelliccia ecologica di colore fucsia, blu o velluto. Uso solo interno. Riedizione (1970).

Ottoman

Pouf with wooden frame and padding in polyurethane foam of varying density. Cover in black Mongolian fur, in fuchsia or blue faux fur or in velvet. Indoor use only. Re-edition (1970).

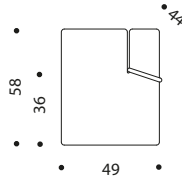

BLOCCO by Nanda Vigo

Modello Model	Codice Code	Categoria materiale - Descrizione materiale Material category - Material description	Prezzo Retail con Iva Retail price with Vat
L. 44 P. 49 H. 58; seduta H. 36 ; P.L. 12,30 Kg; V. 0,190 mc W. 44 D. 49 H. 58; seat H. 36 ; G.W. 12,30 Kg; V. 0,190 cbm 	D00250C700	Cat.A Cotone Bonifacio <i>Cat.A Cotton Bonifacio</i>	980,00
	D00250C701	Cat.A Poliestere Marsiglia <i>Cat.A Polyester Marsiglia</i>	
	D00250C702	Cat.A misto Poliestere, Acrilico, Cotone Petra <i>Cat.A mixed Polyester, Acrylic, Cotton Petra</i>	
	D00250C703	Cat.A misto Poliestere, Acrilico, Cotone Damasco <i>Cat.A mixed Polyester, Acrylic, Cotton Damasco</i>	
	D00250C028	Cat.A Ecopelle Colorado <i>Cat.A Eco-leather Colorado</i>	
	D00250C704	Cat.B misto Poliestere, Acrilico, Cotone Berlino <i>Cat.B mixed Polyester, Acrylic, Cotton Berlino</i>	1.050,00
	D00250C705	Cat.B Poliestere Jakarta <i>Cat.B Polyester Jakarta</i>	
	D00250C706	Cat.B Poliestere Ginevra <i>Cat.B Polyester Ginevra</i>	
	D00250C032	Cat.C Velluto di cotone Loira <i>Cat.C Cotton Velvet Loira</i>	1.150,00
	D00250C036	Cat.C Misto Lino Lisbona <i>Cat.C Linen Mix Lisbona</i>	
D00250C040	Cat.C Lino Barcellona <i>Cat.C Linen Barcellona</i>		
D00250C709	Cat.C Polipropilene Amburgo <i>Cat.C Polypropylene Amburgo</i>		
D00250C710	Cat.C misto Poliestere, Acrilico, Cotone, Lana, Viscosa Berna <i>Cat.C mixed Polyester, Acrylic, Cotton, Wool, Viscose Berna</i>		
D00250C719	Cat.C Poliestere Mosca <i>Cat.C Polyester Mosca</i>		
D00250C712	Cat.D Lana vergine, Cotone, Poliammide Malmö <i>Cat.D virgin Wool, Cotton, Polyamide Malmö</i>	1.250,00	
D00250C713	Cat.D Lana Divina Melange Kvadrat Melange <i>Cat.D Wool Divina Melange Kvadrat Melange</i>		
D00250C714	Cat.E Cotone Venezia <i>Cat.E Cotton Venezia</i>	1.300,00	
D00250C717	Cat.E Modacrilica, Poliestere Pechino <i>Cat.E Modacrylic, Polyester Pechino</i>		
D00250C718	Cat.E Modacrilica, Poliestere Mongolia <i>Cat.E Modacrylic, Polyester Mongolia</i>		
PER LA SCELTA DEI TESSUTI E PELLI CONSULTARE IL LIBRO "ABBINAMENTO TESSUTI-PELLI/MATERIALI" FOR THE CHOICE OF FABRICS AND LEATHERS, SEE BOOK "MATCHING FABRICS-LEATHERS/MATERIALS"			

KOISHI
by Naoto Fukasawa
2007

Pouf

Struttura in fibra di vetro verniciata nei colori bianco, grigio antracite , rosa, giallo e rosso. Uso interno/esterno.

Ottoman

Painted fiberglass structure available in five different colors: white, anthracite grey, pink, yellow and red. Indoor/outdoor use.

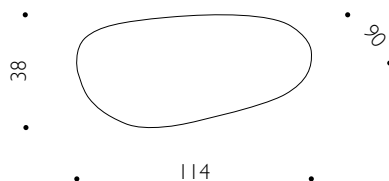

L.114 P.90 H.38
W.114 D.90 H.38
P.L.33 Kg; V.0,486 mc
G.W.33 kg; V.0,486 cbm

Colore
Color

Codice campione
Sample code

Campionario nr.
Sample box n.

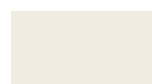

Fibra di vetro verniciata Bianco Ral 9010 lucido
Painted Glass fibre White Ral 9010 glossy

VER002L5

6



Fibra di vetro verniciata Grigio antr.Ral 7021 lucido
Painted Glass fibre Anth. gray Ral 7021 glossy

VER057L2

7



Fibra di vetro verniciata Rosa Ral 030 7020 lucido
Painted Glass fibre Pink Ral 030 7020 glossy

ND/NA



Fibra di vetro verniciata Gialla Ral 1032 lucido
Painted Glass fibre Yellow Ral 1032 glossy

ND/NA



Fibra di vetro verniciata Rosso Ral 3020 lucido
Painted Glass fibre Red Ral 3020 glossy

ND/NA



Codice Code	Colore Color	Prezzo Retail con Iva Retail price with Vat
D04245H369002		1.300,00

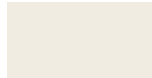

Bianco Ral 9010 lucido
White Ral 9010 glossy



Codice Code	Colore Color	Prezzo Retail con Iva Retail price with Vat
D04245H369057		1.300,00



Grigio antracite Ral 7021 lucido
Anthracite gray Ral 7021 glossy

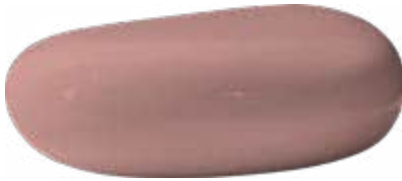

Codice Code	Colore Color	Prezzo Retail con Iva Retail price with Vat
D04245H369024		1.300,00



Rosa Ral 030 7020 lucido
Pink Ral 030 7020 glossy



Codice Code	Colore Color	Prezzo Retail con Iva Retail price with Vat
D04245H369021		1.300,00



Gialla Ral 1032 lucido
Yellow Ral 1032 glossy



Codice Code	Colore Color	Prezzo Retail con Iva Retail price with Vat
D04245H369039		1.300,00



Rosso Ral 3020 lucido
Red Ral 3020 glossy

**POLTRONE/
*ARMCHAIRS***

COCKY
by DriadeLab
2022
Poltrona

Struttura in poliuretano morbido, braccioli, schienale e poggiatesta regolabili. Base in acciaio cromato. Rivestimento fisso in tessuto o pelle. Uso solo interno.

Armchair

Armchair with structure in soft polyurethane, adjustable armrests, backrest and headrest. Base in chromed steel. Fixed cover in fabric or leather. Indoor use only.

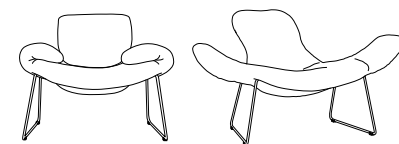
 L. 90 P. 70 H. 73
W. 90 D. 70 H. 73

 L. 143 P. 130 H. 73
W. 143 D. 130 H. 73

Modello Model	Codice Code	Categoria materiale - Descrizione materiale Material category - Material description	Prezzo Retail con Iva Retail price with Vat
	D91102B868	Cat.A Cotone Bonifacio/Acciaio cromato* Cat.A Cotton Bonifacio/Chromed steel*	3.100,00
	D91102B869	Cat.A Poliestere Marsiglia/Acciaio cromato Cat.A Polyester Marsiglia/Chromed steel	
	D91102B870	Cat.A Misto Poliestere, Acrilico, Cotone Petra/Acciaio cromato Cat.A Mixed Polyester, Acrylic, Cotton Petra/Chromed steel	
	D91102B871	Cat.A Misto Poliestere, Acrilico, Cotone Damasco/Acciaio cromato Cat.A Mixed Polyester, Acrylic, Cotton Damasco/Chromed steel	
	D91102B605	Cat.A Ecopelle Colorado/Acciaio cromato Cat.A Eco-leather Colorado/Chromed steel	
	D91102B872	Cat.B Misto Poliestere, Acrilico, Cotone Berlino/Acciaio cromato* Cat.B Mixed Polyester, Acrylic, Cotton Berlino/Chromed steel*	3.500,00
	D91102B873	Cat.B Poliestere Jakarta/Acciaio cromato Cat.B Polyester Jakarta/Chromed steel	
	D91102B874	Cat.B Poliestere Ginevra/Acciaio cromato Cat.B Polyester Ginevra/Chromed steel	
	D91102B867	Cat.C Velluto di Cotone Loira/Acciaio cromato* Cat.C Cotton Velvet Loira/Chromed steel*	3.570,00
	D91102B866	Cat.C misto Lino, Cotone, Viscosa Lisbona/Acciaio cromato Cat.C mixed Linen, Cotton, Viscose Lisbona/Chromed steel	
	D91102B883	Cat.C lino Barcellona/Acciaio cromato* Cat.C Linen Barcellona/Chromed steel*	
	D91102B875	Cat.C Polipropilene Amburgo/Acciaio cromato* Cat.C Polypropylene Amburgo/Chromed steel*	
	D91102B876	Cat.C misto Poliestere, Acrilico, Cotone, Lana, Viscosa Berna/Acc. cromato* Cat.C mixed Polyester, Acrylic, Cotton, Wool, Viscose Berna/Chromed steel*	
	D91102B865	Cat.C Poliestere Mosca/Acciaio cromato Cat.C Polyester Mosca/Chromed steel	
	D91102B877	Cat.D Lana vergine, Cotone, Poliammide Malmö/Acciaio cromato* Cat.D virgin Wool, Cotton, Polyamide Malmö/Chromed steel*	3.600,00
	D91102B878	Cat.E Lana Divina Melange Kvadrat/Acciaio cromato* Cat.E Wool Divina Melange Kvadrat/Chromed steel*	4.000,00
D91102B879	Cat.E Cotone Venezia/Acc. cromato Cat.E Cotton Venezia/Chromed steel		
D91102B880	Cat.E Modacrilica, Poliestere Pechino/Acc. cromato Cat.E Modacrylic, Polyester Pechino/Chromed steel		
D91102B881	Cat.E Modacrilica, Poliestere Mongolia/Acc. cromato Cat.E Modacrylic, Polyester Mongolia/Chromed steel		
D91102B615	Cat.P Pelle Niagara/Acciaio cromato* Cat.P Leather Niagara/Chromed steel*	3.900,00	
D91102B616	Cat.O Pelle Rio/Acciaio cromato Cat.O Leather Rio/Chromed steel	4.200,00	
D91102B617	Cat.ZME Pelle Amur/Acciaio cromato* Cat.ZME Leather Amur/Chromed steel*	4.400,00	
D91102B618	Cat.ZA Pelle Purus/Acciaio cromato* Cat.ZA Leather Purus/Chromed steel*	4.500,00	
D91102B619	Cat.ZC Pelle Churchill/Acciaio cromato* Cat.ZC Leather Churchill/Chromed steel*	5.000,00	

PER LA SCELTA DEI TESSUTI E PELLI CONSULTARE IL LIBRO
"ABBINAMENTO TESSUTI-PELLI/MATERIALI"

FOR THE CHOICE OF FABRICS AND LEATHERS PLEASE REFER TO THE
BOOK "MATCHING FABRICS/LEATHERS/MATERIALS".

 Disponibile la versione ignifuga BS 5852 Domestic con maggiorazione del 10% solo per tessuti e pelli contrassegnati con *. Uso solo interno.

Tessuto Cliente consentito, si prega di fare riferimento al nostro servizio clienti.

Ordine minimo: 2 pezzi.

Available the flame retardant version BS 5852 Domestic with 10% surcharge only for fabrics and leathers marked with *. Indoor use only.

COM and COL allowed, please refer to our Customer Service.

Minimum Order: 2 pcs

Codice campione
Sample code

Campionario nr.
Sample box n.

Acciaio cromato
Chromed steel

ND/NA

COCKY
by DriadeLab
2022

Pouf

Cuscino in poliuretano morbido, base in acciaio cromato. Rivestimento fisso in tessuto o pelle.
Usa solo interno.

Ottoman

Soft polyurethane cushion, chrome-plated steel base. Fixed cover in fabric or leather. Indoor use only.

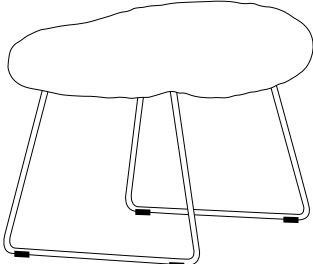

L. 67 P. 52 H. 43
W. 67 D. 52 H. 43

Modello Model	Codice Code	Categoria materiale - Descrizione materiale Material category - Material description	Prezzo Retail con Iva Retail price with Vat
	D91100C868	Cat.A Cotone Bonifacio/Acciaio cromato * Cat.A Cotton Bonifacio/Chromed steel *	1430,00
	D91100C869	Cat.A Poliestere Marsiglia/Acciaio cromato Cat.A Polyester Marsiglia/Chromed steel	
	D91100C870	Cat.A Misto Poliestere, Acrilico, Cotone Petra/Acciaio cromato Cat.A Mixed Polyester, Acrylic, Cotton Petra/Chromed steel	
	D91100C871	Cat.A Misto Poliestere, Acrilico, Cotone Damasco/Acciaio cromato Cat.A Mixed Polyester, Acrylic, Cotton Damasco/Chromed steel	
	D91100C605	Cat.A Ecopelle Colorado/Acciaio cromato Cat.A Eco-leather Colorado/Chromed steel	
	D91100C872	Cat.B Misto Poliestere, Acrilico, Cotone Berlino/Acciaio cromato * Cat.B Mixed Polyester, Acrylic, Cotton Berlino/Chromed steel *	1460,00
	D91100C873	Cat.B Poliestere Jakarta/Acciaio cromato Cat.B Polyester Jakarta/Chromed steel	
	D91100C874	Cat.B Poliestere Ginevra/Acciaio cromato Cat.B Polyester Ginevra/Chromed steel	
	D91100C867	Cat.C Velluto di Cotone Loira/Acciaio cromato * Cat.C Cotton Velvet Loira/Chromed steel *	1480,00
	D91100C866	Cat.C misto Lino, Cotone, Viscosa Lisbona/Acciaio cromato Cat.C mixed Linen, Cotton, Viscose Lisbona/Chromed steel	
	D91100C883	Cat.C lino Barcellona/Acciaio cromato * Cat.C Linen Barcellona/Chromed steel *	
	D91100C875	Cat.C Polipropilene Amburgo/Acciaio cromato * Cat.C Polypropylene Amburgo/Chromed steel *	
	D91100C876	Cat.C misto Poliestere, Acrilico, Cotone, Lana, Viscosa Berna/Acc. cromato * Cat.C mixed Polyester, Acrylic, Cotton, Wool, Viscose Berna/Chromed steel *	
	D91100C865	Cat.C Poliestere Mosca/Acciaio cromato Cat.C Polyester Mosca/Chromed steel	
D91100C877	Cat.D Lana vergine, Cotone, Poliammide Malmö/Acciaio cromato * Cat.D virgin Wool, Cotton, Polyamide Malmö/Chromed steel *	1500,00	
D91100C878	Cat.E Lana Divina Melange Kvadrat/Acciaio cromato * Cat.E Wool Divina Melange Kvadrat/Chromed steel *	1700,00	
D91100C879	Cat.E Cotone Venezia/Acc. cromato Cat.E Cotton Venezia/Chromed steel		
D91100C880	Cat.E Modacrilica, Poliestere Pechino/Acc. cromato Cat.E Modacrylic, Polyester Pechino/Chromed steel		
D91100C881	Cat.E Modacrilica, Poliestere Mongolia/Acc. cromato Cat.E Modacrylic, Polyester Mongolia/Chromed steel		
D91100C615	Cat.P Pelle Niagara/Acciaio cromato * Cat.P Leather Niagara/Chromed steel *	1680,00	
D91100C616	Cat.O Pelle Rio/Acciaio cromato Cat.O Leather Rio/Chromed steel	1750,00	
D91100C617	Cat.ZME Pelle Amur/Acciaio cromato * Cat.ZME Leather Amur/Chromed steel *	1800,00	
D91100C618	Cat.ZA Pelle Purus/Acciaio cromato * Cat.ZA Leather Purus/Chromed steel *	1840,00	
D91100C619	Cat.ZC Pelle Churchill/Acciaio cromato * Cat.ZC Leather Churchill/Chromed steel *	1920,00	

PER LA SCELTA DEI TESSUTI E PELLI CONSULTARE IL LIBRO "ABBINAMENTO TESSUTI-PELLI/MATERIALI"

FOR THE CHOICE OF FABRICS AND LEATHERS PLEASE REFER TO THE BOOK "MATCHING FABRICS/LEATHERS/MATERIALS".

 Disponibile la versione ignifuga BS 5852 Domestic con maggiorazione del 10% solo per tessuti e pelli contrassegnati con *. Uso solo interno.

Tessuto Cliente consentito, si prega di fare riferimento al nostro servizio clienti.

Ordine minimo: 2 pezzi.

Available the flame retardant version BS 5852 Domestic with 10% surcharge only for fabrics and leathers marked with *. Indoor use only.

COM and COL allowed, please refer to our Customer Service.

Minimum Order: 2 pcs

Acciaio cromato
Chromed steel

Codice campione
Sample code
ND/NA

Campionario nr.
Sample box n.

COCKY
by DriadeLab
2022

Poltrona

Struttura in poliuretano morbido, braccioli, schienale e poggiatesta regolabili. Base in acciaio verniciato nero. Rivestimento fisso in tessuto o pelle. Uso solo interno.

Armchair

Armchair with structure in soft polyurethane, adjustable armrests, backrest and headrest. Base in black lacquered steel. Fixed cover in fabric or leather. Indoor use only.

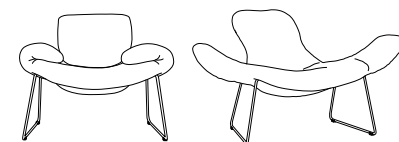

L. 90 P. 70 H. 73
W. 90 D. 70 H. 73

L. 143 P. 130 H. 73
W. 143 D. 130 H. 73

Modello Model	Codice Code	Categoria materiale - Descrizione materiale Material category - Material description	Prezzo Retail con Iva Retail price with Vat
	D91102B722	Cat.A Cotone Bonifacio/Acciaio verniciato nero * Cat.A Cotton Bonifacio/Black painted steel *	3.100,00
	D91102B731	Cat.A Poliestere Marsiglia/Acciaio verniciato nero Cat.A Polyester Marsiglia/Chromed steel	
	D91102B740	Cat.A Misto Poliestere, Acrilico, Cotone Petra/Acciaio verniciato nero Cat.A Mixed Polyester, Acrylic, Cotton Petra/Chromed steel	
	D91102B749	Cat.A Misto Poliestere, Acrilico, Cotone Damasco/Acciaio verniciato nero Cat.A Mixed Polyester, Acrylic, Cotton Damasco/Chromed steel	
	D91102B126	Cat.A Ecopelle Colorado/Acciaio verniciato nero Cat.A Eco-leather Colorado/Chromed steel	
	D91102B758	Cat.B Misto Poliestere, Acrilico, Cotone Berlino/Acciaio verniciato nero * Cat.B Mixed Polyester, Acrylic, Cotton Berlino/Chromed steel *	3.500,00
	D91102B767	Cat.B Poliestere Jakarta/Acciaio verniciato nero Cat.B Polyester Jakarta/Chromed steel	
	D91102B776	Cat.B Poliestere Ginevra/Acciaio verniciato nero Cat.B Polyester Ginevra/Chromed steel	
	D91102B130	Cat.C Velluto di Cotone Loira/Acciaio verniciato nero * Cat.C Cotton Velvet Loira/Chromed steel *	3.570,00
	D91102B134	Cat.C misto Lino, Cotone, Viscosa Lisbona/Acciaio verniciato nero Cat.C mixed Linen, Cotton, Viscose Lisbona/Chromed steel	
	D91102B138	Cat.C lino Barcellona/Acciaio verniciato nero * Cat.C Linen Barcellona/Chromed steel *	
	D91102B785	Cat.C Polipropilene Amburgo/Acciaio verniciato nero * Cat.C Polypropylene Amburgo/Chromed steel *	
	D91102B794	Cat.C misto Poliestere, Acrilico, Cotone, Lana, Viscosa Berna/Acc.vern.nero * Cat.C mixed Polyester, Acrylic, Cotton, Wool, Viscose Berna/Chromed steel *	
	D91102B858	Cat.C Poliestere Mosca/Acciaio verniciato nero Cat.C Polyester Mosca/Chromed steel	
	D91102B803	Cat.D Lana vergine, Cotone, Poliammide Malmö/Acciaio verniciato nero * Cat.D virgin Wool, Cotton, Polyamide Malmö/Chromed steel *	3.600,00
	D91102B812	Cat.E Lana Divina Melange Kvadrat/Acciaio verniciato nero * Cat.E Wool Divina Melange Kvadrat/Chromed steel *	4.000,00
D91102B821	Cat.E Cotone Venezia/Acciaio verniciato nero Cat.E Cotton Venezia/Chromed steel		
D91102B840	Cat.E Modacrilica, Poliestere Pechino/Acciaio verniciato nero Cat.E Modacrylic, Polyester Pechino/Chromed steel		
D91102B849	Cat.E Modacrilica, Poliestere Mongolia/Acciaio verniciato nero Cat.E Modacrylic, Polyester Mongolia/Chromed steel		
D91102B147	Cat.P Pelle Niagara/Acciaio verniciato nero * Cat.P Leather Niagara/Chromed steel *	3.900,00	
D91102B148	Cat.O Pelle Rio/Acciaio verniciato nero * Cat.O Leather Rio/Chromed steel *	4.200,00	
D91102B150	Cat.ZME Pelle Amur/Acciaio verniciato nero * Cat.ZME Leather Amur/Chromed steel *	4.400,00	
D91102B152	Cat.ZA Pelle Purus/Acciaio verniciato nero * Cat.ZA Leather Purus/Chromed steel *	4.500,00	
D91102B149	Cat.ZC Pelle Churchill/Acciaio verniciato nero * Cat.ZC Leather Churchill/Chromed steel *	5.000,00	

PER LA SCELTA DEI TESSUTI E PELLI CONSULTARE IL LIBRO "ABBINAMENTO TESSUTI-PELLI/MATERIALI"

FOR THE CHOICE OF FABRICS AND LEATHERS PLEASE REFER TO THE BOOK "MATCHING FABRICS/LEATHERS/MATERIALS".

Disponibile la versione ignifuga BS 5852 Domestic con maggiorazione del 10% solo per tessuti e pelli contrassegnati con *. Uso solo interno.
Tessuto Cliente consentito, si prega di fare riferimento al nostro servizio clienti.
Ordine minimo: 2 pezzi.
Available the flame retardant version BS 5852 Domestic with 10% surcharge only for fabrics and leathers marked with *. Indoor use only.
COM and COL allowed, please refer to our Customer Service.
Minimum Order: 2 pcs

Codice campione
Sample code

Campionario nr.
Sample box n.

Acciaio verniciato nero
Black lacquered steel

COCKY
by DriadeLab
2022
Pouf

Cuscino in poliuretano morbido, base in acciaio verniciato nero. Rivestimento fisso in tessuto o pelle.
Usa solo interno.

Ottoman

Soft polyurethane cushion, black painted steel base. Fixed cover in fabric or leather. Indoor use only.



L. 67 P. 52 H. 43
W. 67 D. 52 H. 43

Modello Model	Codice Code	Categoria materiale - Descrizione materiale Material category - Material description	Prezzo Retail con Iva Retail price with Vat
	D91100C722	Cat.A Cotone Bonifacio/Acciaio verniciato nero * Cat.A Cotton Bonifacio/Black painted steel *	1430,00
	D91100C731	Cat.A Poliestere Marsiglia/Acciaio verniciato nero Cat.A Polyester Marsiglia/Chromed steel	
	D91100C740	Cat.A Misto Poliestere, Acrilico, Cotone Petra/Acciaio verniciato nero Cat.A Mixed Polyester, Acrylic, Cotton Petra/Chromed steel	
	D91100C749	Cat.A Misto Poliestere, Acrilico, Cotone Damasco/Acciaio verniciato nero Cat.A Mixed Polyester, Acrylic, Cotton Damasco/Chromed steel	
	D91100C126	Cat.A Ecopelle Colorado/Acciaio verniciato nero Cat.A Eco-leather Colorado/Chromed steel	
	D91100C758	Cat.B Misto Poliestere, Acrilico, Cotone Berlino/Acciaio verniciato nero * Cat.B Mixed Polyester, Acrylic, Cotton Berlino/Chromed steel *	1460,00
	D91100C767	Cat.B Poliestere Jakarta/Acciaio verniciato nero Cat.B Polyester Jakarta/Chromed steel	
	D91100C776	Cat.B Poliestere Ginevra/Acciaio verniciato nero Cat.B Polyester Ginevra/Chromed steel	
	D91100C130	Cat.C Velluto di Cotone Loira/Acciaio verniciato nero * Cat.C Cotton Velvet Loira/Chromed steel *	1480,00
	D91100C134	Cat.C misto Lino, Cotone, Viscosa Lisbona/Acciaio verniciato nero Cat.C mixed Linen, Cotton, Viscose Lisbona/Chromed steel	
	D91100C138	Cat.C lino Barcellona/Acciaio verniciato nero * Cat.C Linen Barcellona/Chromed steel *	
	D91100C785	Cat.C Polipropilene Amburgo/Acciaio verniciato nero * Cat.C Polypropylene Amburgo/Chromed steel *	
	D91100C794	Cat.C misto Poliestere, Acrilico, Cotone, Lana, Viscosa Berna/Acc.vern.nero * Cat.C mixed Polyester, Acrylic, Cotton, Wool, Viscose Berna/Chromed steel *	
	D91100C858	Cat.C Poliestere Mosca/Acciaio verniciato nero Cat.C Polyester Mosca/Chromed steel	
D91100C803	Cat.D Lana vergine, Cotone, Poliammide Malmö/Acciaio verniciato nero * Cat.D virgin Wool, Cotton, Polyamide Malmö/Chromed steel *	1500,00	
D91100C812	Cat.E Lana Divina Melange Kvadrat/Acciaio verniciato nero * Cat.E Wool Divina Melange Kvadrat/Chromed steel *	1700,00	
D91100C821	Cat.E Cotone Venezia/Acciaio verniciato nero Cat.E Cotton Venezia/Chromed steel		
D91100C840	Cat.E Modacrilica, Poliestere Pechino/Acciaio verniciato nero Cat.E Modacrylic, Polyester Pechino/Chromed steel		
D91100C849	Cat.E Modacrilica, Poliestere Mongolia/Acciaio verniciato nero Cat.E Modacrylic, Polyester Mongolia/Chromed steel		
D91100C147	Cat.P Pelle Niagara/Acciaio verniciato nero * Cat.P Leather Niagara/Chromed steel *	1680,00	
D91100C148	Cat.O Pelle Rio/Acciaio verniciato nero * Cat.O Leather Rio/Chromed steel *	1750,00	
D91100C150	Cat.ZME Pelle Amur/Acciaio verniciato nero * Cat.ZME Leather Amur/Chromed steel *	1800,00	
D91100C152	Cat.ZA Pelle Purus/Acciaio verniciato nero * Cat.ZA Leather Purus/Chromed steel *	1840,00	
D91100C149	Cat.ZC Pelle Churchill/Acciaio verniciato nero * Cat.ZC Leather Churchill/Chromed steel *	1920,00	

PER LA SCELTA DEI TESSUTI E PELLI CONSULTARE IL LIBRO "ABBINAMENTO TESSUTI-PELLI/MATERIALI"

FOR THE CHOICE OF FABRICS AND LEATHERS PLEASE REFER TO THE BOOK "MATCHING FABRICS/LEATHERS/MATERIALS".

 Disponibile la versione ignifuga BS 5852 Domestic con maggiorazione del 10% solo per tessuti e pelli contrassegnati con *. Usa solo interno.

Tessuto Cliente consentito, si prega di fare riferimento al nostro servizio clienti.

Ordine minimo: 2 pezzi.

Available the flame retardant version BS 5852 Domestic with 10% surcharge only for fabrics and leathers marked with *. Indoor use only.

COM and COL allowed, please refer to our Customer Service.

Minimum Order: 2 pcs

Codice campione
Sample code

Campionario nr.
Sample box n.

Acciaio verniciato nero
Black lacquered steel

COCKY
by DriadeLab
2022
Poltrona

Struttura in poliuretano morbido, braccioli, schienale e poggiatesta regolabili. Base girevole a 5 razze in alluminio lucido. Rivestimento fisso in tessuto o pelle. Uso solo interno.

Armchair

Soft polyurethane frame, adjustable armrests, backrest and headrest. Base in 5-spoke swivel base in polished aluminium. Fixed upholstery in fabric or leather. Indoor use only.



L. 90 P. 70 H. 73
W. 90 D. 70 H. 73



L. 143 P. 130 H. 73
W. 143 D. 130 H. 73

Modello Model	Codice Code	Categoria materiale - Descrizione materiale Material category - Material description	Prezzo Retail con Iva Retail price with Vat
	D91100B723	Cat.A Cotone Bonifacio/Alluminio lucidato <i>Cat.A Cotton Bonifacio/Polished aluminum</i>	3.100,00
	D91100B732	Cat.A Poliestere Marsiglia/Alluminio lucidato <i>Cat.A Polyester Marsiglia/Polished aluminum</i>	
	D91100B741	Cat.A Misto Poliestere, Acrilico, Cotone Petra/Alluminio lucidato <i>Cat.A Mixed Polyester, Acrylic, Cotton Petra/Polished aluminum</i>	
	D91100B750	Cat.A Misto Poliestere, Acrilico, Cotone Damasco/Alluminio lucidato <i>Cat.A Mixed Polyester, Acrylic, Cotton Damasco/Polished aluminum</i>	
	D91100B191	Cat.A Ecopelle Colorado/Alluminio lucidato <i>Cat.A Eco-leather Colorado/Polished aluminum</i>	
	D91100B759	Cat.B Misto Poliestere, Acrilico, Cotone Berlino/Alluminio lucidato <i>Cat.B Mixed Polyester, Acrylic, Cotton Berlino/Polished aluminum</i>	3.500,00
	D91100B768	Cat.B Poliestere Jakarta/Alluminio lucidato <i>Cat.B Polyester Jakarta/Polished aluminum</i>	
	D91100B777	Cat.B Poliestere Ginevra/Alluminio lucidato <i>Cat.B Polyester Ginevra/Polished aluminum</i>	
	D91100B195	Cat.C Velluto di Cotone Loira/Alluminio lucidato <i>Cat.C Cotton Velvet Loira/Polished aluminum</i>	3.570,00
	D91100B199	Cat.C misto Lino, Cotone, Viscosa Lisbona/Alluminio lucidato <i>Cat.C mixed Linen, Cotton, Viscose Lisbona/Polished aluminum</i>	
	D91100B865	Cat.C lino Barcellona/Alluminio lucidato <i>Cat.C Linen Barcellona/Polished aluminum</i>	
	D91100B786	Cat.C Polipropilene Amburgo/Alluminio lucidato <i>Cat.C Polypropylene Amburgo/Polished aluminum</i>	
	D91100B795	Cat.C misto Poliestere, Acrilico, Cotone, Lana, Viscosa Berna/All. lucidato <i>Cat.C mixed Polyester, Acrylic, Cotton, Wool, Viscose Berna/Polished al.</i>	
	D91100B859	Cat.C Poliestere Mosca/Alluminio lucidato <i>Cat.C Polyester Mosca/Polished aluminum</i>	
	D91100B804	Cat.D Lana vergine, Cotone, Poliammide Malmö/Alluminio lucidato <i>Cat.D virgin Wool, Cotton, Polyamide Malmö/Polished aluminum</i>	3.600,00
	D91100B813	Cat.E Lana Divina Melange Kvadrat/Alluminio lucidato <i>Cat.E Wool Divina Melange Kvadrat/Polished aluminum</i>	4.000,00
	D91100B822	Cat.E Cotone Venezia/Alluminio lucidato <i>Cat.E Cotton Venezia/Polished aluminum</i>	
	D91100B841	Cat.E Modacrilica, Poliestere Pechino/Alluminio lucidato <i>Cat.E Modacrylic, Polyester Pechino/Polished aluminum</i>	
	D91100B850	Cat.E Modacrilica, Poliestere Mongolia/Alluminio lucidato <i>Cat.E Modacrylic, Polyester Mongolia/Polished aluminum</i>	
	D91100B213	Cat.P Pelle Niagara/Alluminio lucidato <i>Cat.P Leather Niagara/Polished aluminum</i>	3.900,00
	D91100B212	Cat.O Pelle Rio/Alluminio lucidato <i>Cat.O Leather Rio/Polished aluminum</i>	4.200,00
	D91100B215	Cat.ZME Pelle Amur/Alluminio lucidato <i>Cat.ZME Leather Amur/Polished aluminum</i>	4.400,00
	D91100B217	Cat.ZA Pelle Purus/Alluminio lucidato <i>Cat.ZA Leather Purus/Polished aluminum</i>	4.500,00
	D91100B214	Cat.ZC Pelle Churchill/Alluminio lucidato <i>Cat.ZC Leather Churchill/Polished aluminum</i>	5.000,00

PER LA SCELTA DEI TESSUTI E PELLI CONSULTARE IL LIBRO "ABBINAMENTO TESSUTI-PELLI/MATERIALI"

FOR THE CHOICE OF FABRICS AND LEATHERS PLEASE REFER TO THE BOOK "MATCHING FABRICS/LEATHERS/MATERIALS".

Codice campione
Sample code

Campionario nr.
Sample box nr.

Alluminio lucidato
Polished aluminum

COCKY

by Sfera Ebbasta
2022

Poltrona



Poltrona con struttura in poliuretano morbido, braccioli, schienale e poggiatesta regolabili, rivestimento in ecopelliccia a pelo lungo, base in poliuretano rigido con finitura sputtering oro lucido. Uso solo interno.

Armchair

Armchair with structure in soft polyurethane, armrests, adjustable backrest and headrest, cover in long faux fur, stiff polyurethane base with polished gold sputtering finish. Indoor use only.

L. 90 P. 70 H. 73

W. 90 D. 70 H. 73

Modello Model	Codice Code	Categoria materiale - Descrizione materiale Material category - Material description	Prezzo Retail con Iva Retail price with Vat
	D91102B456G80	Ecopelliccia a pelo lungo di colore bianco White faux fur with long hair	5.950,00
 Poliuretano rigido Stiff polyurethane	Codice campione Sample code ND/NA	Campionario nr. Sample box n.	

ELISA
by Enzo Mari
2015
Poltrona

Struttura realizzata in acciaio verniciato a polveri poliestere black-brown, cuscini in schiuma poliuretanic a densità variabile e fibra di poliestere, con rivestimento in tessuto sfoderabile. Uso solo interno.

Armchair

Structure made of steel finished in black-brown polyester paint, cushions in polyurethane foam of varying density and polyester fiber with removable fabric covering. Indoor use only.

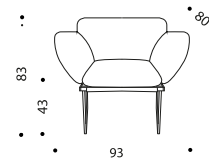

L. 93 P. 80 H. 83; seduta H. 43; P.L. 30 Kg; V. 0,77 mc
W. 93 D. 80 H. 83; seat H. 43; G.W. 30 Kg; V. 0,77 cbm

Modello Model	Codice Code	Categoria materiale - Descrizione materiale Material category - Material description	Prezzo Retail con Iva Retail price with Vat
	D10509A722	Cat.A Cotone Bonifacio/Acciaio verniciato <i>Cat.A Cotton Bonifacio/Painted steel</i>	2.790,00
	D10509A731	Cat.A Poliestere Marsiglia/Acciaio verniciato <i>Cat.A Polyester Marsiglia/Painted steel</i>	
	D10509A740	Cat.A misto Poliestere, Acrilico, Cotone Petra/Acciaio verniciato <i>Cat.A mixed Polyester, Acrylic, Cotton Petra/Painted steel</i>	
	D10509A749	Cat.A misto Poliestere, Acrilico, Cotone Damasco/Acciaio verniciato <i>Cat.A mixed Polyester, Acrylic, Cotton Damasco/Painted steel</i>	
	D10509A758	Cat.B misto Poliestere, Acrilico, Cotone Berlino/Acciaio verniciato <i>Cat.B mixed Polyester, Acrylic, Cotton Berlino/Painted steel</i>	2.950,00
	D10509A767	Cat.B Poliestere Jakarta/Acciaio verniciato <i>Cat.B Polyester Jakarta/Painted steel</i>	
	D10509A776	Cat.B Poliestere Ginevra/Acciaio verniciato <i>Cat.B Polyester Ginevra/Painted steel</i>	
	D10509A130	Cat.C Velluto di cotone Loira/Acciaio verniciato <i>Cat.C cotton Velvet Loira/Painted steel</i>	3.000,00
	D10509A134	Cat.C misto Lino, Cotone, Viscosa Lisbona/Acciaio verniciato <i>Cat.C mixed Linen, Cotton, Viscose Lisbona/Painted steel</i>	
	D10509A138	Cat.C Lino Barcellona/Acciaio verniciato <i>Cat.C Linen Barcellona/Painted steel</i>	
	D10509A785	Cat.C Polipropilene Amburgo/Acciaio verniciato <i>Cat.C Polypropylene Amburgo/Painted steel</i>	
	D10509A794	Cat.C misto Poliestere, Acrilico, Cotone, Lana, Viscosa Berna/Acc. verniciato <i>Cat.C mixed Polyester, Acrylic, Cotton, Wool, Viscose Berna/Painted steel</i>	
	D10509A803	Cat.D misto Lana vergine, Cotone, Poliammide Malmö/Acciaio verniciato <i>Cat.D mixed Virgin Wool, Cotton, Polyamide Malmö/Painted steel</i>	3.500,00
	D10509A812	Cat.E Lana Divina Melange Kvadrat/Acciaio verniciato <i>Cat.E Wool Divina Melange Kvadrat/Painted steel</i>	4.290,00
	D10509A821	Cat.E Cotone Venezia/Acciaio verniciato <i>Cat.E Cotton Venezia/Painted steel</i>	
	D10509A148	Cat.P Pelle Niagara/Acciaio verniciato <i>Cat.P Leather Niagara/Painted steel</i>	4.200,00
	D10509A147	Cat.O Pelle Rio/Acciaio verniciato <i>Cat.O Leather Rio/Painted steel</i>	4.500,00
	D10509A150	Cat.ZME Pelle Amur/Acciaio verniciato <i>Cat.ZME Leather Amur/Painted steel</i>	4.700,00
	D10509A152	Cat.ZA Pelle Purus/Acciaio verniciato <i>Cat.ZA Leather Purus/Painted steel</i>	4.900,00
D10509A149	Cat.ZC Pelle Churchill/Acciaio verniciato <i>Cat.ZC Leather Churchill/Painted steel</i>	5.300,00	

PER LA SCELTA DEI TESSUTI E PELLI CONSULTARE IL LIBRO "ABBINAMENTO TESSUTI-PELLI/MATERIALI"

FOR THE CHOICE OF FABRICS AND LEATHERS, SEE BOOK "MATCHING FABRICS-LEATHERS/MATERIALS"

Codice campione
Sample code

VERD4701

Campionario nr.
Sample box n.

7

HALL

by Rodolfo Dordoni
1992-2018

Poltrona

Struttura in conglomerato ligneo. Imbottitura e cuscini in schiume poliuretaniche e ovatta. Rivestimento fisso in tessuto o pelle. Rivestimento tessuto cliente: quotazione e tempi di consegna da definire all'atto della richiesta. Uso solo interno.

Armchair

Wooden conglomerate structure. Padding in polyurethane foams and wadding. Fabric or leather fixed cover. COM or COL cover: pricing and delivery time to be agreed on demand. Indoor use only.

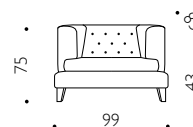

L. 99 P.83 H. 75; seduta H. 43; PL. 40,5 Kg; V. 0,75 mc
W. 99 D. 83 H. 75; seat H. 43; G.W. 40,5 Kg; V. 0,75 cbm

Modello Model	Codice Code	Categoria materiale - Descrizione materiale Material category - Material description	Prezzo Retail con Iva Retail price with Vat
	D80148A700	Cat.A Cotone Bonifacio <i>Cat.A Cotton Bonifacio</i>	3.050,00
	D80148A701	Cat.A Poliestere Marsiglia <i>Cat.A Polyester Marsiglia</i>	
	D80148A702	Cat.A misto Poliestere, Acrilico, Cotone Petra <i>Cat.A mixed Polyester, Acrylic, Cotton Petra</i>	
	D80148A703	Cat.A misto Poliestere, Acrilico, Cotone Damasco <i>Cat.A mixed Polyester, Acrylic, Cotton Damasco</i>	
	D80148A704	Cat.B misto Poliestere, Acrilico, Cotone Berlino <i>Cat.B mixed Polyester, Acrylic, Cotton Berlino</i>	3.200,00
	D80148A705	Cat.B Poliestere Jakarta <i>Cat.B Polyester Jakarta</i>	
	D80148A706	Cat.B Poliestere Ginevra <i>Cat.B Polyester Ginevra</i>	
	D80148A032	Cat.C Velluto di Cotone Loira <i>Cat.C Cotton Velvet Loira</i>	3.400,00
	D80148A036	Cat.C misto Lino, Cotone, Viscosa Lisbona <i>Cat.C mixed Linen, Cotton, Viscose Lisbona</i>	
	D80148A040	Cat.C Lino Barcellona <i>Cat.C Linen Barcellona</i>	
	D80148A709	Cat.C Polipropilene Amburgo <i>Cat.C Polypropylene Amburgo</i>	
	D80148A710	Cat.C misto Poliestere, Acrilico, Cotone, Lana, Viscosa Berna <i>Cat.C mixed Polyester, Acrylic, Cotton, Wool, Viscose Berna</i>	
	D80148A712	Cat.D Lana vergine, Cotone, Poliammide Malmö <i>Cat.D virgin Wool, Cotton, Polyamide Malmö</i>	3.600,00
	D80148A713	Cat.E Lana Divina Melange Kvadrat <i>Cat.E Wool Divina Melange Kvadrat</i>	4.250,00
	D80148A714	Cat.E Cotone Venezia <i>Cat.E Cotton Venezia</i>	
	D80148A050	Cat.P Pelle Niagara <i>Cat.P Leather Niagara</i>	4.150,00
	D80148A049	Cat.O Pelle Rio <i>Cat.O Leather Rio</i>	4.500,00
	D80148A052	Cat.ZME Pelle Amur <i>Cat.ZME Leather Amur</i>	4.900,00
	D80148A054	Cat.ZA Pelle Purus <i>Cat.ZA Leather Purus</i>	5.150,00
D80148A051	Cat.ZC Pelle Churchill <i>Cat.ZC Leather Churchill</i>	5.500,00	

PER LA SCELTA DEI TESSUTI E PELLI CONSULTARE IL LIBRO "ABBINAMENTO TESSUTI-PELLI/MATERIALI"

FOR THE CHOICE OF FABRICS AND LEATHERS, SEE BOOK "MATCHING FABRICS-LEATHERS/MATERIALS"

IPERCUBO

by De Pas, D'Urbino,
Lomazzi
2023

Poltrona

Poltrona con struttura interna in pannelli di legno multistrato e gomme viscoelastiche con densità differenziata per ottenere il massimo comfort di seduta. Caratteristica della poltrona è la discontinuità del piano di seduta con un "taglio" verticale funzionale a permettere profondità di seduta e a creare una sorta di bracciolo su entrambi i lati. Rivestimento fisso in tessuto.

Armchair

Armchair with an internal structure made of multilayer wood panels and viscoelastic rubbers with differentiated density for maximum seating comfort. Characteristic feature of the armchair is the discontinuity of the seating surface with a vertical "cut" functional to allow seating depth and to create a sort of armrest on both sides. Fabric fixed cover.

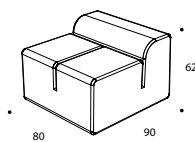

L. 80 P. 90 H. 62; seduta H. 48,5; P.L. 30 Kg; V. 0,55 mc
W. 80 D. 90 H. 62; seat H. 48,5; G.W. 30 Kg; V. 0,55 cbm

Modello Model	Codice Code	Categoria materiale - Descrizione materiale Material category - Material description	Prezzo Retail con Iva Retail price with Vat
	D91168A700	Cat.A Cotone Bonifacio Cat.A Cotton Bonifacio	2.000,00
	D91168A701	Cat.A Poliestere Marsiglia Cat.A Polyester Marsiglia	
	D91168A702	Cat.A misto Poliestere, Acrilico, Cotone Petra Cat.A mixed Polyester, Acrylic, Cotton Petra	
	D91168A703	Cat.A misto Poliestere, Acrilico, Cotone Damasco Cat.A mixed Polyester, Acrylic, Cotton Damasco	
	D91168A704	Cat.B misto Poliestere, Acrilico, Cotone Berlino Cat.B mixed Polyester, Acrylic, Cotton Berlino	2.200,00
	D91168A705	Cat.B Poliestere Jakarta Cat.B Polyester Jakarta	
	D91168A706	Cat.B Poliestere Ginevra Cat.B Polyester Ginevra	
	D91168A032	Cat.C Velluto di cotone Loira Cat.C cotton Velvet Loira	2.300,00
	D91168A036	Cat.C misto Lino, Cotone, Viscosa Lisbona Cat.C mixed Linen, Cotton, Viscose Lisbona	
	D91168A040	Cat.C Lino Barcellona Cat.C Linen Barcellona	
	D91168A709	Cat.C Polipropilene Amburgo Cat.C Polypropylene Amburgo	
	D91168A710	Cat.C misto Poliestere, Acrilico, Cotone, Lana, Viscosa Berna Cat.C mixed Polyester, Acrylic, Cotton, Wool, Viscose Berna	
	D91168A712	Cat.D misto Lana vergine, Cotone, Poliammide Malmö Cat.D mixed Virgin Wool, Cotton, Polyamide Malmö	2.500,00
	D91168A713	Cat.E Lana Divina Melange Kvadrat Cat.E Wool Divina Melange Kvadrat	2.690,00
	D91168A714	Cat.E Cotone Venezia Cat.E Cotton Venezia	
	D91168A148	Cat.P Pelle Niagara Cat.P Leather Niagara	2.650,00
	D91168A147	Cat.O Pelle Rio Cat.O Leather Rio	2.880,00
	D91168A150	Cat.ZME Pelle Amur Cat.ZME Leather Amur	3.020,00
	D91168A152	Cat.ZA Pelle Purus Cat.ZA Leather Purus	3.300,00
D91168A149	Cat.ZC Pelle Churchill Cat.ZC Leather Churchill	4.050,00	

PER LA SCELTA DEI TESSUTI E PELLI CONSULTARE IL LIBRO "ABBINAMENTO TESSUTI-PELLI/MATERIALI"

FOR THE CHOICE OF FABRICS AND LEATHERS, SEE BOOK "MATCHING FABRICS-LEATHERS/MATERIALS"

IPERCUBO
by De Pas, D'Urbino,
Lomazzi
2023

Cuscino

Cuscino poggiatesta per poltrona Ipercubo, imbottitura in fibra sintetica e rivestimento sfoderabile in tessuto, fisso in pelle. Uso solo interno.

Cushion

Backrest cushion for Ipercubo armchair, padding in synthetic fiber and removable cover in fabric, fixed in leather. Indoor use only.

L. 70 P.27 H. 12

W. 70 D. 27 H. 12

Modello Model	Codice Code	Categoria materiale - Descrizione materiale Material category - Material description	Prezzo Retail con Iva Retail price with Vat
	D91162G700	Cat.A Cotone Bonifacio <i>Cat.A Cotton Bonifacio</i>	260,00
	D91162G701	Cat.A Poliestere Marsiglia <i>Cat.A Polyester Marsiglia</i>	
	D91162G702	Cat.A misto Poliestere, Acrilico, Cotone Petra <i>Cat.A mixed Polyester, Acrylic, Cotton Petra</i>	
	D91162G703	Cat.A misto Poliestere, Acrilico, Cotone Damasco <i>Cat.A mixed Polyester, Acrylic, Cotton Damasco</i>	
	D91162G704	Cat.B misto Poliestere, Acrilico, Cotone Berlino <i>Cat.B mixed Polyester, Acrylic, Cotton Berlino</i>	290,00
	D91162G705	Cat.B Poliestere Jakarta <i>Cat.B Polyester Jakarta</i>	
	D91162G706	Cat.B Poliestere Ginevra <i>Cat.B Polyester Ginevra</i>	
	D91162G032	Cat.C Velluto di cotone Loira <i>Cat.C cotton Velvet Loira</i>	330,00
	D91162G036	Cat.C misto Lino, Cotone, Viscosa Lisbona <i>Cat.C mixed Linen, Cotton, Viscose Lisbona</i>	
	D91162G040	Cat.C Lino Barcellona <i>Cat.C Linen Barcellona</i>	
	D91162G709	Cat.C Polipropilene Amburgo <i>Cat.C Polypropylene Amburgo</i>	
	D91162G710	Cat.C misto Poliestere, Acrilico, Cotone, Lana, Viscosa Berna <i>Cat.C mixed Polyester, Acrylic, Cotton, Wool, Viscose Berna</i>	
	D91162G712	Cat.D misto Lana vergine, Cotone, Poliammide Malmö <i>Cat.D mixed Virgin Wool, Cotton, Polyamide Malmö</i>	370,00
	D91162G713	Cat.E Lana Divina Melange Kvadrat <i>Cat.E Wool Divina Melange Kvadrat</i>	580,00
	D91162G714	Cat.E Cotone Venezia <i>Cat.E Cotton Venezia</i>	
	D91162G148	Cat.P Pelle Niagara <i>Cat.P Leather Niagara</i>	540,00
	D91162G147	Cat.O Pelle Rio <i>Cat.O Leather Rio</i>	630,00
	D91162G150	Cat.ZME Pelle Amur <i>Cat.ZME Leather Amur</i>	680,00
	D91162G152	Cat.ZA Pelle Purus <i>Cat.ZA Leather Purus</i>	790,00
D91162G149	Cat.ZC Pelle Churchill <i>Cat.ZC Leather Churchill</i>	1.110,00	

PER LA SCELTA DEI TESSUTI E PELLI CONSULTARE IL LIBRO "ABBINAMENTO TESSUTI-PELLI/MATERIALI"

FOR THE CHOICE OF FABRICS AND LEATHERS, SEE BOOK "MATCHING FABRICS-LEATHERS/MATERIALS"

ITALIC
by Fabio Novembre
2019**Poltrona**

Poltrona composta da volumi di dichiarata derivazione architettonica e dalla geometria rigorosa, caratterizzata dall'inclinazione e dal bracciolo sospeso. Il fusto è costruito in abete e la seduta resa confortevole da cinghie elastiche. L'imbottitura è realizzata con schiume poliuretaniche a densità differenziata. Il rivestimento fisso in velluto Loira definisce i volumi con cuciture ribattute doppie. Disponibile in quattro varianti di colore. Uso solo interno.

Armchair

Composed of volumes of a declared architectural derivation and rigorous geometry, characterised by the angle and suspended armrest. The frame is made of fir and the seat is made comfortable by elastic straps. The upholstery is made of polyurethane foams with different densities. The fixed fabric cover defines the volumes with double riveted seams. Indoor use only.



D00038A032165



D00038A032167



D00038A032168



D00038A032169

ITALIC by Fabio Novembre, 2019

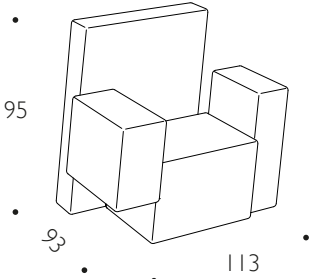
Modello Model	Codice Code	Categoria materiale - Descrizione materiale Material category - Material description	Prezzo Retail con Iva Retail price with Vat
Poltrona L. 113 P. 93 H. 95; P.L. 30 Kg; V. 1,272 mc Armchair W. 113 D. 93 H. 95; G.W. 30 Kg; V. 1,272 cbm	D00038A032165	Cat.B Velluto Loira: Rosso 039 Rosso scuro 038 Bordeaux 040 Viola scuro 031 Cat.B Velvet Loira: Red 039 Dark red 038 Burgundy 040 Dark violet 031	3.200,00
	D00038A032167	Cat.B Velluto Loira: Marrone 081 Marrone scuro 083 Nero 091 Grigio 044 Cat.B Velvet Loira: Brown 081 Dark brown 083 Black 091 Grey 044	3.200,00
	D00038A032168	Cat.B Velluto Loira: Blu 072 Blu scuro 073 Nero 091 Petrolio 069 Cat.B Velvet Loira: Blue 072 Dark blue 073 Black 091 Petrol green 069	3.200,00
	D00038A032169	Cat.B Velluto Loira: Verde scuro 066 Blu 072 Marrone scuro 083 Rosso 039 Cat.B Velvet Loira: Dark green 066 Blue 072 Dark brown 083 Red 039	3.200,00
	D00038A032714	Cat.E Cotone Venezia Cat.E Cotton Venezia	3.850,00

LIRICA

by Ludovica + Roberto
Palomba
2017

Poltrona

Struttura in legno dotata di cinghiatura elastica e imbottitura in schiume poliuretatiche a quote differenziate. Cuscino di seduta in schiume poliuretatiche a quote differenziate. Cuscino di schienale incluso. Rivestimento sfoderabile in tessuto o fisso in pelle. Piedi in fusione di alluminio, verniciato di colore nero o argento. Uso solo interno. CUSCINI DECORATIVI A PAG.208.

Armchair

Wood structure with elastic belting and padding in polyurethane foams with different densities. Seat cushion in polyurethane foams with different densities. Back cushion included. Removable cover in fabric or fixed in leather. Feet in cast aluminum, painted in black or silver color. Indoor use only. THROW CUSHIONS PAGE 208.

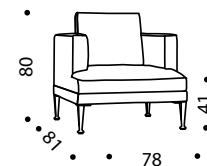

L. 78 P. 81 H. 80; seduta H. 41; P.L. 23 Kg; V.0,60 mc
W. 78 D. 81 H. 80; seat H. 41; G.W. 23 Kg; V.0,60 cbm



PER LA SCELTA DEI TESSUTI E PELLI CONSULTARE IL LIBRO "ABBINAMENTO TESSUTI-PELLI/MATERIALI"

FOR THE CHOICE OF FABRICS AND LEATHERS, SEE BOOK "MATCHING FABRICS-LEATHERS/MATERIALS"



Alluminio verniciato
argento
Painted Aluminum
silver

Codice campione
Sample code

VER04301

Campionario nr.
Sample box n.

7



Alluminio verniciato
Nero Ral 9005 opaco
Painted Aluminum
Matt Black Ral 9005

Codice campione
Sample code

VER09103

Campionario nr.
Sample box n.

7

Modello Model	Codice Code	Categoria materiale - Descrizione materiale Material category - Material description	Prezzo Retail con Iva Retail price with Vat
	D43729A724	Cat.A Cotone Bonifacio/Alluminio verniciato Cat.A Cotton Bonifacio/Painted Aluminum	2.450,00
	D43729A733	Cat.A Poliestere Marsiglia/Alluminio verniciato Cat.A Polyester Marsiglia/Painted Aluminum	
	D43729A742	Cat.A misto Poliestere, Acrilico, Cotone Petra/Alluminio verniciato Cat.A mixed Polyester, Acrylic, Cotton Petra/Painted Aluminum	
	D43729A751	Cat.A misto Poliestere, Acrilico, Cotone Damasco/Alluminio verniciato Cat.A mixed Polyester, Acrylic, Cotton Damasco/Painted Aluminum	
	D43729A223	Cat.A Ecopelle Colorado/Alluminio verniciato Cat.A Eco-leather Colorado/Painted Aluminum	
	D43729A760	Cat.B misto Poliestere, Acrilico, Cotone Berlino/Alluminio verniciato Cat.B mixed Polyester, Acrylic, Cotton Berlino/Painted Aluminum	2.500,00
	D43729A769	Cat.B Poliestere Jakarta/Alluminio verniciato Cat.B Polyester Jakarta/Painted Aluminum	
	D43729A778	Cat.B Poliestere Ginevra/Alluminio verniciato Cat.B Polyester Ginevra/Painted Aluminum	
	D43729A224	Cat.C Velluto di cotone Loira/Alluminio verniciato Cat.C Cotton Velvet Loira/Painted Aluminum	2.700,00
	D43729A228	Cat.C Misto Lino Lisbona/Alluminio verniciato Cat.C Linen Mix Lisbona/Painted Aluminum	
D43729A232	Cat.C Lino Barcellona/ Alluminio verniciato Cat.C Linen Barcellona/Painted Aluminum		
D43729A787	Cat.C Polipropilene Amburgo/Alluminio verniciato Cat.C Polypropylene Amburgo/Painted Aluminum		
D43729A805	Cat.D Lana vergine, Cotone, Poliammide Malmö/ Alluminio verniciato Cat.D virgin Wool, Cotton, Polyamide Malmö/Painted Aluminum	2.850,00	
D43728A814	Cat.E Lana Divina Melange Kvadrat/Alluminio verniciato Cat.E Wool Divina Melange Kvadrat/Painted Aluminum	2.990,00	
D43728A823	Cat.E Cotone Venezia/Alluminio verniciato Cat.E Cotton Venezia/Painted Aluminum		
D43728A242	Cat.P Pelle Niagara/Alluminio verniciato Cat.P Leather Niagara/Painted Aluminum	3.130,00	
D43728A241	Cat.O Pelle Rio/Alluminio verniciato Cat.O Leather Rio/Painted Aluminum	3.390,00	
D43728A244	Cat.ZME Pelle Amur/Alluminio verniciato Cat.ZME Leather Amur/Painted Aluminum	3.860,00	
D43728A246	Cat.ZA Pelle Purus/Alluminio verniciato Cat.ZA Leather Purus/Painted Aluminum	4.230,00	
D43728A243	Cat.ZC Pelle Churchill/Alluminio verniciato Cat.ZC Leather Churchill/Painted Aluminum	4.400,00	

LISA
by Laudani & Romanelli
2009

Poltrona

Monoblocco in schiume poliuretaniche con inserto metallico. Imbottitura in schiume poliuretaniche con rivestimento fisso in tessuto o pelle. Rivestimento tessuto cliente: quotazione e tempi di consegna da definire all'atto della richiesta. Uso solo interno.

Armchair

Polyurethane foam monobloc with metal insert. Padding in polyurethane foams with fabric or leather fixed cover. COM or COL cover: pricing and delivery time to be agreed on demand. Indoor use only.

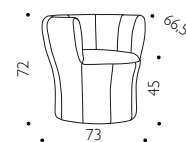

L. 73 P. 66,5 H. 72; seduta H. 45; P.L. 20 Kg; V. 0,454 mc
W. 73 D. 66,5 H. 72; seat H. 45; G.W. 20 Kg; V. 0,454 cbm



PER LA SCELTA DEI TESSUTI E PELLI CONSULTARE IL LIBRO "ABBINAMENTO TESSUTI-PELLI/MATERIALI"

FOR THE CHOICE OF FABRICS AND LEATHERS, SEE BOOK "MATCHING FABRICS-LEATHERS/MATERIALS"

Modello Model	Codice Code	Categoria materiale - Descrizione materiale Material category - Material description	Prezzo Retail con Iva Retail price with Vat
	D20008A700	Cat.A Cotone Bonifacio Cat.A Cotton Bonifacio	1.720,00
	D20008A701	Cat.A Poliestere Marsiglia Cat.A Polyester Marsiglia	
	D20008A702	Cat.A misto Poliestere, Acrilico, Cotone Petra Cat.A mixed Polyester, Acrylic, Cotton Petra	
	D20008A703	Cat.A misto Poliestere, Acrilico, Cotone Damasco Cat.A mixed Polyester, Acrylic, Cotton Damasco	
	D20008A033	Cat.A Ecopelle Colorado Cat.A Eco-leather Colorado	
	D20008A704	Cat.B misto Poliestere, Acrilico, Cotone Berlino Cat.B mixed Polyester, Acrylic, Cotton Berlino	1.840,00
	D20008A705	Cat.B Poliestere Jakarta Cat.B Polyester Jakarta	
	D20008A706	Cat.B Poliestere Ginevra Cat.B Polyester Ginevra	
	D20008A032	Cat.C Velluto di cotone Loira Cat.C Cotton Velvet Loira	1.950,00
	D20008A036	Cat.C Misto Lino Lisbona Cat.C Linen Mix Lisbona	
D20008A040	Cat.C Lino Barcellona Cat.C Linen Barcellona		
D20008A709	Cat.C Polipropilene Amburgo Cat.C Polypropylene Amburgo		
D20008A710	Cat.C misto Poliestere, Acrilico, Cotone, Lana, Viscosa Berna Cat.C mixed Polyester, Acrylic, Cotton, Wool, Viscose Berna		
D20008A712	Cat.D Lana vergine, Cotone, Poliammide Malmö Cat.D virgin Wool, Cotton, Polyamide Malmö	2.050,00	
D20008A713	Cat.E Lana Divina Melange Kvadrat Cat.E Wool Divina Melange Kvadrat	2.350,00	
D20008A714	Cat.E Cotone Venezia Cat.E Cotton Venezia		
D20008A050	Cat.P Pelle Niagara Cat.P Leather Niagara	2.280,00	
D20008A049	Cat.O Pelle Rio Cat.O Leather Rio	2.500,00	
D20008A052	Cat.ZME Pelle Amur Cat.ZME Leather Amur	2.730,00	
D20008A054	Cat.ZA Pelle Purus Cat.ZA Leather Purus	2.950,00	
D20008A051	Cat.ZC Pelle Churchill Cat.ZC Leather Churchill	3.280,00	

LOU READ

by Philippe Starck &
Eugeni Quitllet
2011

Poltrona

Struttura in poliuretano Baydur® con inserto metallico e rivestimento in pelle nelle categorie P, O e Z. Uso solo interno.

Armchair

Polyurethane Baydur® structure with internal metal reinforcement. Leather cover available in category P, O and Z. Indoor use only.

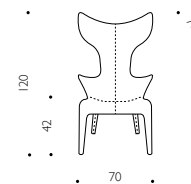

L. 70 P. 76 H. 120; seduta H. 42; P.L. 46 Kg; V. 0,930 mc
W. 70 D. 76 H. 120; seat H. 42; G.W. 46 Kg; V. 0,930 cbm

Modello Model	Codice Code	Categoria materiale - Descrizione materiale Material category - Material description	Prezzo Retail con Iva Retail price with Vat
	D73002B050	Cat.P Pelle Niagara Cat.P Leather Niagara	4.950,00
	D73002B049	Cat.O Pelle Rio Cat.O Leather Rio	5.600,00
	D73002B052	Cat.ZME Pelle Amur Cat.ZME Leather Amur	6.280,00
	D73002B054	Cat.ZA Pelle Purus Cat.ZA Leather Purus	6.720,00
	D73002B051	Cat.ZC Pelle Churchill Cat.ZC Leather Churchill	6.830,00
	D73002B053	Cat.ZS Sacramento Cat.ZS Sacramento	7.380,00

PER LA SCELTA DEI TESSUTI E PELLI CONSULTARE IL
LIBRO "ABBINAMENTO TESSUTI-PELLI/MATERIALI"

FOR THE CHOICE OF FABRICS AND LEATHERS, SEE
BOOK "MATCHING FABRICS-LEATHERS/MATERIALS"

LOU SPEAK

by Philippe Starck
2017

Poltrona

Base girevole in fusione di alluminio lucidata a specchio. Scocca in schiuma poliuretana con struttura interna portante in tondino di acciaio. Rivestimento fisso in tessuto o pelle. Uso solo interno.

Armchair

Swivel base made of cast aluminum in polished mirror finish. Shell in polyurethane foam with internal structure in steel rod, with fabric or leather fixed cover. Indoor use only.

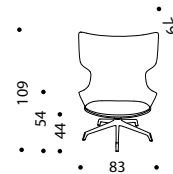

L. 83 P. 79 H. 109; seduta H. 44; bracciolo H. 54;
P.L. 36 Kg; V. 0,855 mc
W. 83 D. 79 H. 109; seat H. 44; armrest H. 54;
G.W. 36 Kg; V. 0,855 cbm

Modello Model	Codice Code	Categoria materiale - Descrizione materiale Material category - Material description	Prezzo Retail con Iva Retail price with Vat
	D73500B702	Cat.A misto Poliestere, Acrilico, Cotone Petra/Alluminio lucidato Cat.A mixed Polyester, Acrylic, Cotton Petra/Polished aluminum	3.000,00
	D73500B703	Cat.A misto Poliestere, Acrilico, Cotone Damasco/Alluminio lucidato Cat.A mixed Polyester, Acrylic, Cotton Damasco/Polished aluminum	
	D73500B704	Cat.B misto Poliestere, Acrilico, Cotone Berlino/Alluminio lucidato Cat.B mixed Polyester, Acrylic, Cotton Berlino/Polished aluminum	3.390,00
	D73500B195	Cat.C Velluto di cotone Loira /Alluminio lucidato Cat.C cotton Velvet Loira/Polished aluminum	3.700,00
	D73500B199	Cat.C Misto Lino Lisbona /Alluminio lucidato Cat.C Linen Mix Lisbona/Polished aluminum	
	D73500B714	Cat.E Cotone Venezia/Alluminio lucidato Cat.E Cotton Venezia/Polished aluminum	6.600,00
	D73500B213	Cat.P Pelle Niagara/Alluminio lucidato Cat.P Leather Niagara/Polished aluminum	6.550,00
	D73500B212	Cat.O Pelle Rio/Alluminio lucidato Cat.O Leather Rio/Polished aluminum	7.000,00
	D73500B215	Cat.ZME Pelle Amur/Alluminio lucidato Cat.ZME Leather Amur/Polished aluminum	7.400,00
	D73500B217	Cat.ZA Pelle Purus/Alluminio lucidato Cat.ZA Leather Purus/Polished aluminum	7.900,00
	D73500B214	Cat.ZC Pelle Churchill/Alluminio lucidato Cat.ZC Leather Churchill/Polished aluminum	7.990,00

PER LA SCELTA DEI TESSUTI E PELLI CONSULTARE IL LIBRO "ABBINAMENTO TESSUTI-PELLI/MATERIALI"

FOR THE CHOICE OF FABRICS AND LEATHERS, SEE BOOK "MATCHING FABRICS-LEATHERS/MATERIALS"

Alluminio lucidato
Polished Aluminum

Codice campione
Sample code

MET114L1

Campionario nr.
Sample box n.

7

MOON

by Ludovica + Roberto
Palomba
2018

Poltrona

Struttura portante in filo di acciaio in finitura a cromo lucido. Scocca in baydur600 laccata opaca nei colori mattone, ecrù o lucida nel colore nero. Cuscino di seduta con rivestimento sfoderabile in tessuto o in pelle. Uso solo interno.

Armchair

Supporting structure in steel wire in polished chrome finish. Shell in baydur600 in matt lacquered in the colors red brick, beige and glossy black. Seat cushion with removable fabric or leather cover. Indoor use only.

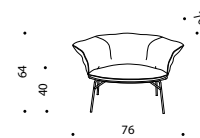

L. 76 P. 70 H. 64; seduta H. 40; P.L. Kg: 21; V. 0,512 mc
W. 76 D. 70 H. 64; seat H. 40; G.W. Kg: 21; V. 0,512 cbm

Modello Model	Codice Code	Categoria materiale - Descrizione materiale Material category - Material description	Prezzo Retail con Iva Retail price with Vat
	D30258A728	Poliuretano rigido verniciato/Cat. A Cotone Bonifacio/Acciaio cromato Stiff polyurethane/Cat. A Cotton Bonifacio/Chromed steel	2.090,00
	D30258A737	Poliuretano rigido verniciato/Cat. A Poliestere Marsiglia/Acciaio cromato Stiff polyurethane/Cat. A Polyester Marsiglia/Chromed steel	
	D30258A746	Pol. rigido verniciato/Cat. A misto Poliestere, Acrilico, Cotone Petra/Acciaio cromato Stiff pol./Cat. A mixed Polyester, Acrylic, Cotton Petra/Chromed steel	
	D30258A755	Pol. rigido verniciato/Cat. A misto Poliestere, Acrilico, Cotone Damasco/Acciaio cromato Stiff pol./Cat. A mixed Polyester, Acrylic, Cotton Damasco/Chromed steel	
	D30258A395	Pol. rigido verniciato/Cat. A Ecopelle Colorado/Acciaio cromato Stiff pol./Cat. A Eco-leather Colorado/Chromed steel	
	D30258A764	Pol. rigido verniciato/Cat. B misto Poliestere, Acrilico, Cotone Berlino/Acciaio cromato Stiff pol./Cat. B mixed Polyester, Acrylic, Cotton Berlino/Chromed steel	2.200,00
	D30258A773	Poliuretano rigido verniciato/Cat. B Poliestere Jakarta/Acciaio cromato Stiff polyurethane/Cat. B Polyester Jakarta/Chromed steel	
	D30258A782	Poliuretano rigido verniciato/Cat. B Poliestere Ginevra/Acciaio cromato Stiff polyurethane/Cat. B Polyester Geneva/Chromed steel	
	D30258A399	Poliuretano rigido verniciato/Cat. C Velluto di cotone Loira/Acciaio cromato Stiff polyurethane/Cat. C Cotton Velvet Loira/Chromed steel	2.300,00
	D30258A403	Poliuretano rigido verniciato/Cat. C Misto Lino Lisbona/Acciaio cromato Stiff polyurethane/Cat. C Linen Mix Lisbona/Chromed steel	
	D30258A407	Poliuretano rigido verniciato/Cat. C Lino Barcellona/ Acciaio cromato Stiff polyurethane/Cat. C Linen Barcellona/Chromed steel	
	D30258A791	Poliuretano rigido verniciato/Cat. C Polipropilene Amburgo/Acciaio cromato Stiff polyurethane/Cat. C Polypropylene Amburgo/Chromed steel	
D30258A800	Pol. rigido vern./Cat. C misto Poliestere, Acrilico, Cotone, Lana, Viscosa Berna/Acc. cromato Stiff pol./Cat. C mixed Polyester, Acrylic, Cotton, Wool, Viscose Berna/Chromed steel		
D30258A864	Poliuretano rigido verniciato/Cat. C Poliestere Mosca/Acciaio cromato Stiff polyurethane/Cat. C Polyester Mosca/Chromed steel		
D30258A809	Pol. rigido verniciato/Cat. D Lana vergine, Cotone, Poliammide Malmö/Acc. cromato Stiff polyurethane/Cat. D virgin wool, cotton, polyamide Malmö/Chromed steel	2.520,00	
D30258A818	Pol. rigido verniciato/Cat. E Lana Divina Melange Kvadrat/Acc. cromato Stiff polyurethane/Cat. E Wool Divina Melange Kvadrat Chromed steel	2.750,00	
D30258A827	Poliuretano rigido verniciato/Cat. E Cotone Venezia/Acciaio cromato Stiff polyurethane/Cat. E Cotton Venezia/Chromed steel		
D30258A846	Pol. rigido verniciato/Cat. E Modacrilica, Poliestere Pechino/Acc. cromato Stiff polyurethane/Cat. E Modacrylic, Polyester Pechino/Chromed steel		
D30258A417	Poliuretano rigido verniciato/Cat. P Pelle Niagara/Acciaio cromato Stiff polyurethane/Cat. P Leather Niagara/Chromed steel	2.560,00	
D30258A416	Poliuretano rigido verniciato/Cat. O Pelle Rio/Acciaio cromato Stiff polyurethane/Cat. O Leather Rio/Chromed steel	2.910,00	
D30258A421	Poliuretano rigido verniciato/Cat. ZA Pelle Purus/Acciaio cromato Stiff polyurethane/Cat. ZA Leather Purus/Chromed steel	3.390,00	
D30258A418	Poliuretano rigido verniciato/Cat. ZC Pelle Churchill/Acciaio cromato Stiff polyurethane/Cat. ZC Leather Churchill/Chromed steel	3.780,00	

PER LA SCELTA DELLA SCOCCA, TESSUTI E PELLI
CONSULTARE IL LIBRO "ABBINAMENTO TESSUTI-PELLI/
MATERIALI"

FOR THE CHOICE OF SHELL, FABRICS AND LEATHERS,
SEE BOOK "MATCHING FABRICS-LEATHERS/
MATERIALS"

Scocca/Shell



Poliuretano rigido Ecrù
Ecrù rigid Polyurethane

Codice campione
Sample code
VER00901

Campionario nr.
Sample box n.
6



Poliuretano rigido Nero
Ral 9005 lucido
Glossy Black Ral 9005
rigid Polyurethane

Codice campione
Sample code
VER091L4

Campionario nr.
Sample box n.
7



Poliuretano rigido Mattone
Brick rigid Polyurethane

Codice campione
Sample code
VER03701

Campionario nr.
Sample box n.
6

Struttura/Structure



Acciaio cromato
Chromed steel

Codice campione
Sample code
ND/NA

Campionario nr.
Sample box n.

MOON

by Ludovica + Roberto
Palomba
2018

Poltrona

Struttura portante in filo di acciaio in finitu a cromo lucido. Scocca in baydur600 con rivestimento in pelle non sfoderabile. Cuscino di seduta con rivestimento in pelle sfoderabile. Uso solo interno.

Armchair

Supporting structure in steel wire in polished chrome finish. Shell in baydur600 with leather fixed cover. Seat cushion with removable leather cover. Indoor use only.

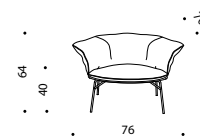

L. 76 P. 70 H. 64; seduta H. 40; P.L. Kg: 21; V. 0,512 mc
W. 76 D. 70 H. 64; seat H. 40; G.W. Kg: 21; V. 0,512 cbm

Modello Model	Codice Code	Categoria materiale - Descrizione materiale Material category - Material description	Prezzo Retail con Iva Retail price with Vat
	D30258A184	Cat.P Pelle Niagara Cat.P Leather Niagara	2.670,00
	D30258A183	Cat.O Pelle Rio Cat.O Leather Rio	3.000,00
	D30258A188	Cat.ZA Pelle Purus Cat.ZA Leather Purus	3.500,00
	D30258A185	Cat.ZC Pelle Churchill Cat.ZC Leather Churchill	3.890,00



PER LA SCELTA DEI TESSUTI E PELLI CONSULTARE IL
LIBRO "ABBINAMENTO TESSUTI-PELLI/MATERIALI"

FOR THE CHOICE OF FABRICS AND LEATHERS, SEE
BOOK "MATCHING FABRICS-LEATHERS/MATERIALS"

Struttura/Structure



Acciaio cromato
Chromed steel

Codice campione
Sample code

ND/NA

Campionario nr.
Sample box n.

NEILby Ludovica+Roberto
Palomba
2018**Poltrona**

Struttura in legno massello di abete e pannello in multistrato, piedino di appoggio a terra in plastica. La struttura nei suoi componenti, schienale, base e bracciolo viene completata da una cinghiatura elastica per ottenere il massimo comfort. Tutte le imbottiture sono costituite da gomme poliuretatiche a densità variabile e resinati con grammatura differenziata. Rivestimento in tessuto sfoderabile o in pelle fisso. Uso solo interno

Armchair

Made of a solid fir wood structure and multilayer panel, plastic foot. The structure in its components, back, base and armrest is completed by an elastic belt for maximum comfort. All upholstery consists of polyurethane rubbers with variable density and resin with different weight. Removable fabric or fixed leather cover. Indoor use only.

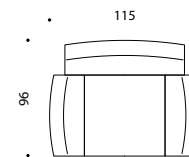

L. 115 P. 96 H. 75; seduta H. 42
W. 115 D. 6 H. 75; seat H. 42



Modello Model	Codice Code	Categoria materiale - Descrizione materiale Material category - Material description	Prezzo Retail con Iva Retail price with Vat
<p>PER LA SCELTA DEI TESSUTI E PELLI CONSULTARE IL LIBRO "ABBINAMENTO TESSUTI-PELLI/MATERIALI"</p> <p>FOR THE CHOICE OF FABRICS AND LEATHERS, SEE BOOK "MATCHING FABRICS-LEATHERS/MATERIALS"</p>	D43268A700	Cat.A Cotone Bonifacio Cat.A Cotton Bonifacio	4.490,00
	D43268A701	Cat.A Poliestere Marsiglia Cat.A Polyester Marsiglia	
	D43268A702	Cat.A misto Poliestere, Acrilico, Cotone Petra Cat.A mixed Polyester, Acrylic, Cotton Petra	
	D43268A703	Cat.A misto Poliestere, Acrilico, Cotone Damasco Cat.A mixed Polyester, Acrylic, Cotton Damasco	
	D43268A704	Cat.B misto Poliestere, Acrilico, Cotone Berlino Cat.B mixed Polyester, Acrylic, Cotton Berlino	4.800,00
	D43268A705	Cat.B Poliestere Jakarta Cat.B Polyester Jakarta	
	D43268A706	Cat.B Poliestere Ginevra Cat.B Polyester Ginevra	
	D43268A032	Cat.C Velluto di cotone Loira Cat.C Cotton Velvet Loira	5.050,00
	D43268A036	Cat.C Misto Lino Lisbona Cat.C Linen Mix Lisbona	
	D43268A040	Cat.C Lino Barcellona Cat.C Linen Barcellona	
	D43268A709	Cat.C Polipropilene Amburgo Cat.C Polypropylene Amburgo	
	D43268A710	Cat.C misto Poliestere, Acrilico, Cotone, Lana, Viscosa Berna Cat.C mixed Polyester, Acrylic, Cotton, Wool, Viscose Berna	
	D43268A712	Cat.D Lana vergine, Cotone, Poliammide Malmö Cat.D virgin Wool, Cotton, Polyamide Malmö	5.400,00
	D43268A713	Cat.E Lana Divina Melange Kvadrat Cat.E Wool Divina Melange Kvadrat	6.250,00
	D43268A714	Cat.E Cotone Venezia Cat.E Cotton Venezia	
	D43268A050	Cat.P Pelle Niagara Cat.P Leather Niagara	6.150,00
D43268A049	Cat.O Pelle Rio Cat.O Leather Rio	6.650,00	
D43268A052	Cat.ZME Pelle Amur Cat.ZME Leather Amur	7.200,00	
D43268A054	Cat.ZA Pelle Purus Cat.ZA Leather Purus	7.550,00	
D43268A051	Cat.ZC Pelle Churchill Cat.ZC Leather Churchill	8.350,00	

NEMO
by Fabio Novembre
2011

Poltrona
Poltrona monoblocco realizzata mediante stampaggio rotazionale in polietilene fissa o girevole (solo uso interno) disponibile nei colori: bianco, nero, rosso, grigio. Sarà possibile realizzare la poltrona Nemo laccata in RAL cliente, con tempistica di approntamento di 4 settimane data ordine e sovrapprezzo del 30%.

Armchair
Polyethylene armchair made by rotational molding fixed or swivel (indoor use only) available in the colors: white, black, red, grey. It will be possible to realize the lacquered Nemo with a customized color (only if RAL referenced). The lead time will be of 4 weeks after the order confirmation and a surcharge of 30% will be applied on the current retail price.

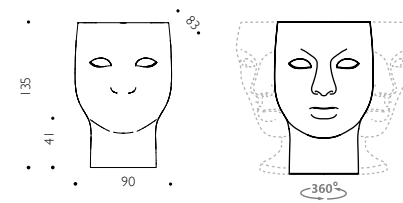

L. 90 P. 83 H. 135; seduta H. 41; P.L. 35 Kg; V. 1,08 mc
W. 90 D. 83 H. 135; seat H. 41; G.W. 35 Kg; V. 1,08 cbm



Codice versione fissa <i>Code fixed version</i>	Colore <i>Color</i>	Prezzo Retail con Iva <i>Retail price with Vat</i>
---	-------------------------------	--

D42802B278002	Bianco Ral 9016 <i>White Ral 9016</i>	1.490,00
---------------	--	----------

Codice versione girevole (solo uso interno)
Code swivel version (indoor use only)

D42800B278002	Bianco Ral 9016 <i>White Ral 9016</i>	1.820,00
---------------	--	----------



Polietilene
Polyethilene

Codice campione <i>Sample code</i>	Campionario nr. <i>Sample box n.</i>
PLA002O2	5



Codice versione fissa <i>Code fixed version</i>	Colore <i>Color</i>	Prezzo Retail con Iva <i>Retail price with Vat</i>
---	-------------------------------	--

D42802B278091	Nero Ral 9011 <i>Black Ral 9011</i>	1.490,00
---------------	--	----------

Codice versione girevole (solo uso interno)
Code swivel version (indoor use only)

D42800B278091	Nero Ral 9011 <i>Black Ral 9011</i>	1.820,00
---------------	--	----------



Polietilene
Polyethilene

Codice campione <i>Sample code</i>	Campionario nr. <i>Sample box n.</i>
PLA091O2	5



Codice versione fissa <i>Code fixed version</i>	Colore <i>Color</i>	Prezzo Retail con Iva <i>Retail price with Vat</i>
---	-------------------------------	--

D42802B278039	Rosso Pantone 1797C <i>Red Pantone 1797C</i>	1.490,00
---------------	---	----------

Codice versione girevole (solo uso interno)
Code swivel version (indoor use only)

D42800B278039	Rosso Pantone 1797C <i>Red Pantone 1797C</i>	1.820,00
---------------	---	----------



Polietilene
Polyethilene

Codice campione <i>Sample code</i>	Campionario nr. <i>Sample box n.</i>
PLA039O1	5



Codice <i>Code</i>	Colore <i>Color</i>	Prezzo Retail con Iva <i>Retail price with Vat</i>
------------------------------	-------------------------------	--

D42802B278044	Grigio Pantone 7537U <i>Grey Pantone 7537U</i>	1.490,00
---------------	---	----------

Codice versione girevole (solo uso interno)
Code swivel version (indoor use only)

D42800B278044	Grigio Pantone 7537U <i>Grey Pantone 7537U</i>	1.820,00
---------------	---	----------



Polietilene
Polyethilene

Codice campione <i>Sample code</i>	Campionario nr. <i>Sample box n.</i>
PLA044O1	5

NEMO
by Fabio Novembre
2011

Poltrona
Poltrona monoblocco realizzata mediante stampaggio rotazionale in polietilene fissa o girevole verniciata nei colori rosso, nero oppure Denim. Sarà possibile realizzare la poltrona Nemo laccata in RAL cliente, con tempistica di approntamento di 4 settimane data ordine e sovrapprezzo del 30%.

Armchair
Polyethylene armchair made by rotational molding fixed or swivel in red or black lacquered or Denim polyethylene. It will be possible to realize the lacquered Nemo with a customized color (only if RAL referenced). The lead time will be of 4 weeks after the order confirmation and a surcharge of 30% will be applied on the current retail price.

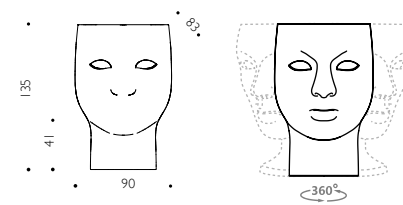

L. 90 P. 83 H. 135; seduta H. 41; P.L. 35 Kg; V. 1,08 mc
W. 90 D. 83 H. 135; seat H. 41; G.W. 35 Kg; V. 1,08 cbm



Codice versione fissa Code fixed version	Colore Color	Prezzo Retail con Iva Retail price with Vat
---	-----------------	--

D42802B279039	Rosso Pantone 485C Red Pantone 485C	2.990,00
---------------	--	----------

Codice versione girevole (solo uso interno)
Code swivel version (indoor use only)

D42800B279039	Bianco Ral 9016 White Ral 9016	3.350,00
---------------	-----------------------------------	----------



Polietilene laccato
Lacquered polyethylene

Codice campione Sample code	Campionario nr. Sample box n.
VER039L3	6

Codice versione fissa Code fixed version	Colore Color	Prezzo Retail con Iva Retail price with Vat
---	-----------------	--

D42802B279091	Nero Ral 9017 Black Ral 9017	2.990,00
---------------	---------------------------------	----------

Codice versione girevole (solo uso interno)
Code swivel version (indoor use only)

D42800B279091	Nero Ral 9017 Black Ral 9017	3.350,00
---------------	---------------------------------	----------



Polietilene
Lacquered polyethylene

Codice campione Sample code	Campionario nr. Sample box n.
VER091L6	7



Codice versione fissa Code fixed version	Colore Color	Prezzo Retail con Iva Retail price with Vat
---	-----------------	--

D42802B278130	Denim Denim	1.790,00
---------------	----------------	----------

Codice versione girevole (solo uso interno)
Code swivel version (indoor use only)

D42800B278130	Denim Denim	2.250,00
---------------	----------------	----------



Polietilene
Polyethylene

Codice campione Sample code	Campionario nr. Sample box n.
ND/NA	

NEMO
BLACK IS THE
NEW GREEN
by Fabio Novembre
2021

Poltrona

Il materiale con il quale è realizzata la poltrona Nemo, deriva da riciclo industriale proveniente da scarti di produzione interna, e pertanto controllati, e da riciclo post consumo vale a dire da prodotti smaltiti con raccolta differenziata - come l'esempio di bottiglie e contenitori in PET - e riciclati dando così vita a nuovi oggetti.

Armchair

The armchair Nemo is made of material which comes from industrial recycling, partly from internal production waste, and therefore controlled, and partly from post-consumer recycling, i.e. from products disposed of with separate collection - such as PET bottles - and recycled thus giving life to new objects.

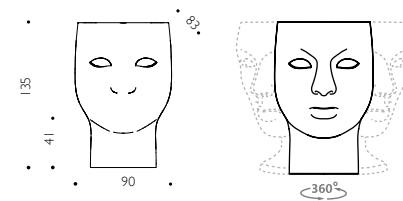

L. 90 P. 83 H. 135; seduta H. 41; P.L. 35 Kg; V. 1,08 mc
W. 90 D. 83 H. 135; seat H. 41; G.W. 35 Kg; V. 1,08 cbm



Codice versione fissa
Code fixed version

D42802B476091

Prezzo Retail con Iva
Retail price with Vat

1.490,00

Codice versione girevole (solo uso interno)
Code swivel version (indoor use only)

D42800B476091

1.820,00



Polietilene riciclato nero
Eco Black Polyethylene

Codice campione
Sample code

ND/NA

Campionario nr.
Sample box n.

NEMO CUSTOM

by Fabio Novembre
2021

Poltrona

Le Nemo Custom sono eco-friendly perchè realizzate con l'utilizzo di vernici di nuova generazione. Driade continua la sua ricerca verso una produzione che preveda un sempre minore impatto ambientale grazie all'impiego di vernici acriliche opache all'acqua che conferiscono al prodotto una particolare resistenza all'usura, alla luce e agli agenti atmosferici oltre ad ottenere un aspetto estetico, e al tatto, morbido e "setoso". Infinite le combinazioni possibili per personalizzare la propria Nemo scegliendo il colore preferito per l'esterno della poltrona e decidendo se mantenere l'interno dello stesso colore oppure sceglierlo in una versione neutra: nero o bianco.

Armchair

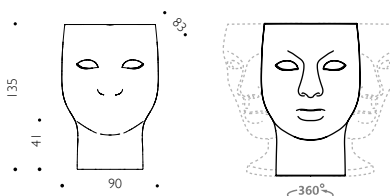

Nemo Custom are eco-friendly because they are made using new generation paints. Driade continues its research towards a production that foresees the lowest environmental impact thanks to the use of water-based matt acrylic paints that give the product a particular resistance to the use, to the light and to atmospheric agents as well as an aesthetic appearance, a soft and "silky" touch. There are countless possible combinations to personalise your Nemo by choosing your favourite colour for the outside of the armchair and deciding whether to keep the inside of the same colour or choose a neutral version: black or white.



L. 90 P. 83 H. 135; seduta H. 41; P.L. 35 Kg; V. 1,08 mc
W. 90 D. 83 H. 135; seat H. 41; G.W. 35 Kg; V. 1,08 cbm



NEMO CUSTOM by Fabio Novembre, 2021

Codice Code	Materiale Material	Colore Color	Consegna Delivery	Prezzo Retail con Iva Retail price with Vat
D42802B477 Versione fissa <i>Fixed version</i> 	Polietilene verniciato opaco soft touch <i>Soft touch matt varnished polyethylene</i>	rif. RAL <i>ref. RAL</i>	6 settimane dalla conferma d'ordine <i>6 weeks from order confirmation</i>	3.050,00
D42800B477 Versione girevole (solo uso interno) <i>Swivel version (Indoor use only)</i> 	Polietilene verniciato opaco soft touch <i>Soft touch matt varnished polyethylene</i>	rif. RAL <i>ref. RAL</i>	6 settimane dalla conferma d'ordine <i>6 weeks from order confirmation</i>	3.630,00



Ral 1000



Ral 9003



Ral 9010



Ral 1017



Ral 3015



Ral 6013



Ral 9002



Ral 1015



Ral 2003



Ral 3014



Ral 6011



Ral 6019



Ral 1014



Ral 2008



Ral 3018



Ral 6010



Ral 6021



Ral 1016



Ral 2011



Ral 3028



Ral 6003



Ral 6018



Ral 1018



Ral 2009



Ral 3020



Ral 6006



Ral 6017



Ral 1003



Ral 2004



Ral 3001



Ral 6007



Ral 6037



Ral 1033



Ral 2001



Ral 3003



Ral 6008



Ral 6029



Ral 1028



Ral 2002



Ral 3004



Ral 6009



Ral 6028



Ral 1037



Ral 2013



Ral 3005



Ral 6022



Ral 6005



Ral 2000



Ral 2009



Ral 3007



Ral 4009



Ral 5024



Ral 7047



Ral 9018



Ral 9016



Ral 4003



Ral 5023



Ral 7040



Ral 7035



Ral 7038



Ral 4010



Ral 5007



Ral 5014



Ral 6034



Ral 7045



Ral 4006



Ral 5000



Ral 5012



Ral 6027



Ral 7001



Ral 4008



Ral 5013



Ral 5015



Ral 6033



Ral 7000



Ral 4001



Ral 5003



Ral 5019



Ral 5013



Ral 7031



Ral 4005



Ral 5022



Ral 5017



Ral 5021



Ral 7011



Ral 4011



Ral 5008



Ral 5005



Ral 5025



Ral 7024



Ral 4012



Ral 5011



Ral 5010



Ral 5001



Ral 7016



Ral 4007



Ral 5004



Ral 5026



Ral 5020



Ral 9011

PAVO
by Patricia Urquiola,
2006

Poltroncina

Struttura in acciaio verniciato, rivestita in midollino di colore marrone. Cuscino di seduta con imbottitura e rivestimento in pelle nera. Uso solo interno.

Armchair

Painted steel brown cane covered structure. Fixed cushion with black leather cover. Indoor use only.

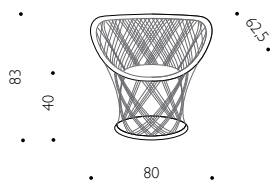

L. 80 P. 62,5 H. 83; Seduta H. 40; P.L. 14 Kg; V. 0,454 mc
W. 80 D 62,5 H. 83; Seat H. 40; G.W. 14 Kg; V. 0,454 cbm



Codice
Code
D01764A280081

Colore
Color

Prezzo Retail con Iva
Retail price with Vat

2.250,00



Midollino
Cane

Codice campione
Sample code

ND/NA

Campionario nr.
Sample box n.

PAVO REAL
by Patricia Urquiola,
2006

Poltrona

Struttura in acciaio verniciato, rivestita in midollino di colore marrone. Cuscino di seduta con imbottitura e rivestimento in pelle nera. Uso solo interno.

Armchair

Painted steel brown cane covered structure. Fixed cushion with black leather cover. Indoor use only.

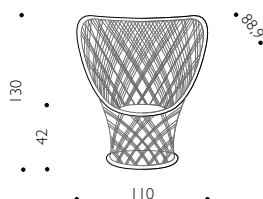

L. 110 P. 88,9 H. 130; Seduta H. 42; P.L. 25 Kg; V. 1,350 mc
W. 110 D 88,9 H. 130; Seat H. 42; G.W. 25 Kg; V. 1,350 cbm



Codice
Code
D01758A280081

Colore
Color

Prezzo Retail con Iva
Retail price with Vat

3.320,00



Midollino
Cane

Codice campione
Sample code

ND/NA

Campionario nr.
Sample box n.

SUKI
by Toyo Ito
1988
Poltrona

Struttura in tubo di acciaio inox satinato. Seduta in lamiera di acciaio inox forata. Uso solo interno.

Armchair

Tubular stainless satin steel structure with perforated stainless steel sheet. Indoor use only.

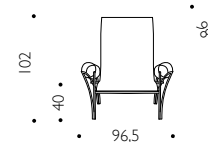

L. 96,5 P. 98 H. 102; seduta H. 40; P.L. 27 Kg; V. 1,12 mc
W. 96,5 D. 98 H. 102; seat H. 40; G.W. 27 Kg; V. 1,12 cbm



Codice
Code

D00118A009107

Colore
Color

Satinato
Satinated

Prezzo Retail con Iva
Retail price with Vat

11.300,00

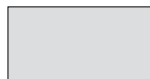

Acciaio inox
Stainless steel

Codice campione
Sample code

ND/NA

Campionario nr.
Sample box n.

TOTTORI

by Kateryna Sokolova
2021

Sedia, poltrona, divanetto

Struttura in poliuretano flessibile a media densità, piedini in PE per l'appoggio a terra. Il rivestimento è fisso con la possibilità di materiali differenti per le gambe rispetto a quelli di seduta e schienale. Uso solo interno.

Chair, armchair, sofa

Structure in medium density flexible polyurethane, PE feet for ground support. The cover is fixed with the possibility of different materials for the legs than those of the seat and back. Indoor use only.

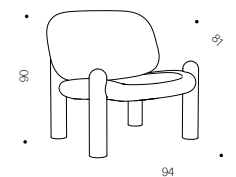

L. 94 P. 81 H. 90; seduta H. 43; P.L. 34,5 Kg; V. 0,781 mc
W. 94 D. 81 H. 90; seat H. 43; G.W. 34,5 Kg; V. 0,781 cbm



PER LA SCELTA DELLA SCOCCA, TESSUTI E PELLI
CONSULTARE IL LIBRO "ABBINAMENTO TESSUTI-PELLI/
MATERIALI"

FOR THE CHOICE OF SHELL, FABRICS AND LEATHERS,
SEE BOOK "MATCHING FABRICS-LEATHERS/
MATERIALS"

 Disponibile la versione ignifuga BS 5852 Domestic con maggiorazione del 10% solo per tessuti e pelli contrassegnati con *. Uso solo interno.
Tessuto Cliente consentito, si prega di fare riferimento al nostro servizio clienti.
Ordine minimo: 4 pezzi.
Available the flame retardant version BS 5852 Domestic with 10% surcharge only for fabrics and leathers marked with *. Indoor use only.
COM and COL allowed, please refer to our Customer Service.
Minimum Order: 4 pcs

Modello Model	Codice Code	Categoria materiale - Descrizione materiale Material category - Material description	Prezzo Retail con Iva Retail price with Vat
	DA5648A700	Cat.A Cotone Bonifacio * Cat.A Cotton Bonifacio *	1.900,00
	DA5648A701	Cat.A Poliestere Marsiglia Cat.A Polyester Marsiglia	
	DA5648A702	Cat.A misto Poliestere, Acrilico, Cotone Petra Cat.A mixed Polyester, Acrylic, Cotton Petra	
	DA5648A703	Cat.A misto Poliestere, Acrilico, Cotone Damasco Cat.A mixed Polyester, Acrylic, Cotton Damasco	
	DA5648A704	Cat.B misto Poliestere, Acrilico, Cotone Berlino * Cat.B mixed Polyester, Acrylic, Cotton Berlino *	2.050,00
	DA5648A705	Cat.B Poliestere Jakarta Cat.B Polyester Jakarta	
	DA5648A706	Cat.B Poliestere Ginevra Cat.B Polyester Ginevra	
	DA5648A036	Cat.C Misto Lino Lisbona Cat.C Linen Mix Lisbona	2.140,00
	DA5648A040	Cat.C Lino Barcellona * Cat.C Linen Barcellona *	
	DA5648A709	Cat.C Polipropilene Amburgo * Cat.C Polypropylene Amburgo *	
	DA5648A710	Cat.C misto Poliestere, Acrilico, Cotone, Lana, Viscosa Berna * Cat.C mixed Polyester, Acrylic, Cotton, Wool, Viscose Berna *	
	DA5648A712	Cat.D Lana vergine, Cotone, Poliammide Malmö Cat.D virgin Wool, Cotton, Polyamide Malmö	2.300,00
DA5648A713	Cat.E Lana Divina Melange Kvadrat * Cat.E Wool Divina Melange Kvadrat *	2.700,00	
DA5648A049	Cat.O Pelle Rio * Cat.O Leather Rio *	2.850,00	
DA5648A052	Cat.ZME Pelle Amur * Cat.ZME Leather Amur *	2.950,00	
DA5648A054	Cat.ZA Pelle Purus * Cat.ZA Leather Purus *	3.150,00	
DA5648A051	Cat.ZC Pelle Churchill * Cat.ZC Leather Churchill *	3.750,00	

VIGLIUS

by Matteo Thun &
Antonio Rodriguez
2007

Poltrona

Struttura in legno cinghiata. Piedi in legno di faggio laccato nero. Imbottitura in schiume poliuretaniche e ovatta. Rivestimento fisso in tessuto o pelle. Rivestimento tessuto cliente: quotazione e tempi di consegna da definire all'atto della richiesta. Uso solo interno.

Armchair

Black lacquered beechwood legs and polyurethane foams padded wooden structure with fabric or leather fixed cover. COM or COL cover: pricing and delivery time to be agreed on demand. Indoor use only.

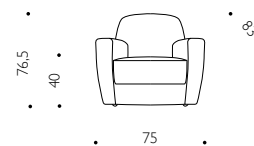

L. 75 P. 83 H. 76,5; sed. H. 40; bracc. H. 54; P.L. 28 Kg; V. 0,576 mc
W. 75 D. 83 H. 76,5; seat H. 40; armrest H. 54; G.W. 28 Kg; V. 0,576 cbm

Modello Model	Codice Code	Categoria materiale - Descrizione materiale Material category - Material description	Prezzo Retail con Iva Retail price with Vat
	D10918A700	Cat.A Cotone Bonifacio <i>Cat.A Cotton Bonifacio</i>	1.620,00
	D10918A701	Cat.A Poliestere Marsiglia <i>Cat.A Polyester Marsiglia</i>	
	D10918A702	Cat.A misto Poliestere, Acrilico, Cotone Petra <i>Cat.A mixed Polyester, Acrylic, Cotton Petra</i>	
	D10918A703	Cat.A misto Poliestere, Acrilico, Cotone Damasco <i>Cat.A mixed Polyester, Acrylic, Cotton Damasco</i>	
	D10918A028	Cat.A Ecopelle Colorado <i>Cat.A Eco-leather Colorado</i>	
	D10918A704	Cat.B misto Poliestere, Acrilico, Cotone Berlino <i>Cat.B mixed Polyester, Acrylic, Cotton Berlino</i>	1.720,00
	D10918A705	Cat.B Poliestere Jakarta <i>Cat.B Polyester Jakarta</i>	
	D10918A706	Cat.B Poliestere Ginevra <i>Cat.B Polyester Ginevra</i>	
	D10918A032	Cat.C Velluto di cotone Loira <i>Cat.C Cotton Velvet Loira</i>	1.950,00
	D10918A036	Cat.C Misto Lino Lisbona <i>Cat.C Linen Mix Lisbona</i>	
	D10918A040	Cat.C Lino Barcellona <i>Cat.C Linen Barcellona</i>	
	D10918A709	Cat.C Polipropilene Amburgo <i>Cat.C Polypropylene Amburgo</i>	
	D10918A710	Cat.C misto Poliestere, Acrilico, Cotone, Lana, Viscosa Berna <i>Cat.C mixed Polyester, Acrylic, Cotton, Wool, Viscose Berna</i>	
	D10918A712	Cat.D Lana vergine, Cotone, Poliammide Malmö <i>Cat.D virgin Wool, Cotton, Polyamide Malmö</i>	2.250,00
	D10918A713	Cat.E Lana Divina Melange Kvadrat <i>Cat.E Wool Divina Melange Kvadrat</i>	2.350,00
	D10918A714	Cat.E Cotone Venezia <i>Cat.E Cotton Venezia</i>	
D10918A050	Cat.P Pelle Niagara <i>Cat.P Leather Niagara</i>	2.280,00	
D10918A049	Cat.O Pelle Rio <i>Cat.O Leather Rio</i>	2.500,00	
D10918A052	Cat.ZME Pelle Amur <i>Cat.ZME Leather Amur</i>	2.600,00	
D10918A054	Cat.ZA Pelle Purus <i>Cat.ZA Leather Purus</i>	2.900,00	
D10918A051	Cat.ZC Pelle Churchill <i>Cat.ZC Leather Churchill</i>	3.450,00	

PER LA SCELTA DELLA SCOCCA, TESSUTI E PELLI
CONSULTARE IL LIBRO "ABBINAMENTO TESSUTI-PELLI/
MATERIALI"

FOR THE CHOICE OF SHELL, FABRICS AND LEATHERS,
SEE BOOK "MATCHING FABRICS-LEATHERS/
MATERIALS"

WIREFLOW
 by Michel Rojkind
2019
Chaise longue

Struttura in tubo verniciato di colore bianco o nero e scocca in poliuretano flessibile. Rivestimento in pelle con cuciture a "doppio ago" sulla superficie di seduta. La chaise longue prevede un cuscino appoggiatesta regolabile in altezza mediante contrappeso. Uso solo interno.

Chaise longue

Structure in white or black painted tube and flexible polyurethane shell. Leather cover with "double needle" stitching on the seat surface. The chaise longue has a height adjustable headrest cushion with counterweight. Indoor use only.



L. 79 P. 205 H. 82; P.L. 41 Kg; V. 1,881 mc
W. 79 D. 205 H. 82; G.W. 41 Kg; V. 1,881 cbm

Modello Model	Codice Code	Categoria materiale - Descrizione materiale Material category - Material description	Prezzo Retail con Iva Retail price with Vat
	D00083B150	Cat.ZME Pelle Amur/Acciaio verniciato Cat.ZME Leather Amur/Painted steel	4.390,00
	D00083B152	Cat.ZA Pelle Purus/Acciaio verniciato Cat.ZA Leather Purus/Painted steel	4.710,00
	D00083B149	Cat.ZC Pelle Churchill/Acciaio verniciato Cat.ZC Leather Churchill/Painted steel	5.245,00



PER LA SCELTA DELLE PELLI CONSULTARE IL LIBRO
"ABBINAMENTO TESSUTI-PELLI/MATERIALI"

FOR THE CHOICE OF LEATHERS, SEE BOOK
"MATCHING FABRICS-LEATHERS/MATERIALS"

	Acciaio verniciato Bianco White painted Steel	Codice campione Sample code VER002L1	Campionario nr. Sample box n. 6
--	--	--	---------------------------------------

	Acciaio vern. Nero Ral 9005 opaco Matt Black Ral 9005 painted Steel	Codice campione Sample code VER091O3	Campionario nr. Sample box n. 7
--	--	--	---------------------------------------

**DIVANI/
SOFAS**

33 CUSCINI

by Paolo Rizzato
2013

Divano tre posti



Struttura in acciaio, piedi in acciaio curvato, imbottitura in schiume poliuretaniche.
Rivestimento sfoderabile in velluto Loira nei toni del rosso, oppure monocolori in tessuto.
Usa solo interno.

Three-seater sofa

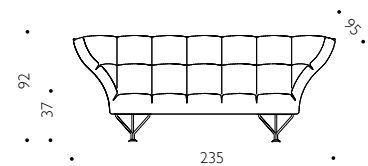
Steel structure, curved steel legs and polyurethane foam padding. Removable cover in velvet Loira in the shades of red or in single-color fabric. Indoor use only.



L 235 P. 95 H. 92; seduta H. 37; PL. 85 Kg; V. 2,228 mc
W. 235 D. 95 H. 92; seat H. 37; G.W. 85 Kg; V. 2,228 cbm

Modello Model	Codice Code	Categoria materiale - Descrizione materiale Material category - Material description	Prezzo Retail con Iva Retail price with Vat
	D30106C130	Cat.C Velluto di cotone Loira/Acciaio verniciato Cat.C cotton Velvet Loira/Painted steel	8.500,00
	D30106C722	Cat.A Cotone Bonifacio/Acciaio verniciato Cat.A Cotton Bonifacio/Painted steel	7.350,00
	D30106C731	Cat.A Poliestere Marsiglia/Acciaio verniciato Cat.A Polyester Marsiglia/Painted steel	
	D30106C740	Cat.A misto Poliestere, Acrilico, Cotone Petra/Acciaio verniciato Cat.A mixed Polyester, Acrylic, Cotton Petra/Painted steel	
	D30106C749	Cat.A misto Poliestere, Acrilico, Cotone Damasco/Acciaio verniciato Cat.A mixed Polyester, Acrylic, Cotton Damasco/Painted steel	
	D30106C758	Cat.B misto Poliestere, Acrilico, Cotone Berlino/Acciaio verniciato Cat.B mixed Polyester, Acrylic, Cotton Berlino/Painted steel	7.980,00
	D30106C767	Cat.B Poliestere Jakarta/Acciaio verniciato Cat.B Polyester Jakarta/Painted steel	
	D30106C776	Cat.B Poliestere Ginevra/Acciaio verniciato Cat.B Polyester Ginevra/Painted steel	
	D30106C130	Cat.C Velluto di cotone Loira/Acciaio verniciato Cat.C cotton Velvet Loira/Painted steel	8.500,00
	D30106C134	Cat.C misto Lino, Cotone, Viscosa Lisbona/Acciaio verniciato Cat.C mixed Linen, Cotton, Viscose Lisbona/Painted steel	
	D30106C138	Cat.C Lino Barcellona/Acciaio verniciato Cat.C Linen Barcellona/Painted steel	
	D30106C785	Cat.C Polipropilene Amburgo/Acciaio verniciato Cat.C Polypropylene Amburgo/Painted steel	
	D30106C803	Cat.D misto Lana vergine, Cotone, Poliammide Malmö/Acciaio verniciato Cat.D mixed virgin Wool, Cotton, Polyamide Malmö/Painted steel	9.150,00
	D30106C812	Cat.E Lana Divina Melange Kvadrat/Acciaio verniciato Cat.E Wool Divina Melange Kvadrat/Painted steel	9.650,00
	D30106C821	Cat.E Cotone Venezia/Acciaio verniciato Cat.E Cotton Venezia/Painted steel	

PER LA SCELTA DEI TESSUTI E PELLI CONSULTARE IL LIBRO "ABBINAMENTO TESSUTI-PELLI/MATERIALI"

FOR THE CHOICE OF FABRICS AND LEATHERS, SEE BOOK "MATCHING FABRICS-LEATHERS/MATERIALS"



Codice campione
Sample code

Campionario nr.
Sample box n.

ND/NA

33 CUSCINI
by Paolo Rizzato
2013

Pouf

Struttura in acciaio, piedi in acciaio curvato, imbottitura in schiume poliuretaniche.
Rivestimento sfoderabile in velluto Loira nei toni del rosso, oppure monocolori in tessuto.
Usa solo interno.

Ottoman

Steel structure, curved steel legs and polyurethane foam padding. Removable cover in velvet Loira in the shades of red or in single-color fabric. Indoor use only.

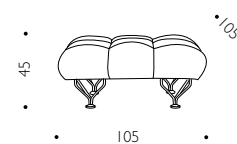

L 105 P. 105 H. 45; P.L. 26 Kg; V. 0,496 mc
W. 105 D. 105 H. 45; G.W. 26 Kg; V. 0,496 cbm

Modello Model	Codice Code	Categoria materiale - Descrizione materiale Material category - Material description	Prezzo Retail con Iva Retail price with Vat
	D30151C130	Cat.C Velluto di cotone Loira/Acciaio verniciato Cat.C cotton Velvet Loira/Painted steel	2.950,00
	D30151C722	Cat.A Cotone Bonifacio/Acciaio verniciato Cat.A Cotton Bonifacio/Painted steel	2.790,00
	D30151C731	Cat.A Poliestere Marsiglia/Acciaio verniciato Cat.A Polyester Marsiglia/Painted steel	
	D30151C740	Cat.A misto Poliestere, Acrilico, Cotone Petra/Acciaio verniciato Cat.A mixed Polyester, Acrylic, Cotton Petra/Painted steel	
	D30151C749	Cat.A misto Poliestere, Acrilico, Cotone Damasco/Acciaio verniciato Cat.A mixed Polyester, Acrylic, Cotton Damasco/Painted steel	
	D30151C758	Cat.B misto Poliestere, Acrilico, Cotone Berlino/Acciaio verniciato Cat.B mixed Polyester, Acrylic, Cotton Berlino/Painted steel	2.900,00
	D30151C767	Cat.B Poliestere Jakarta/Acciaio verniciato Cat.B Polyester Jakarta/Painted steel	
	D30151C776	Cat.B Poliestere Ginevra/Acciaio verniciato Cat.B Polyester Ginevra/Painted steel	
	D30151C130	Cat.C Velluto di cotone Loira/Acciaio verniciato Cat.C cotton Velvet Loira/Painted steel	2.950,00
<p>PER LA SCELTA DEI TESSUTI E PELLI CONSULTARE IL LIBRO "ABBINAMENTO TESSUTI-PELLI/MATERIALI"</p> <p>FOR THE CHOICE OF FABRICS AND LEATHERS, SEE BOOK "MATCHING FABRICS-LEATHERS/MATERIALS"</p>	D30151C134	Cat.C misto Lino, Cotone, Viscosa Lisbona/Acciaio verniciato Cat.C mixed Linen, Cotton, Viscose Lisbona/Painted steel	
	D30151C138	Cat.C Lino Barcellona/Acciaio verniciato Cat.C Linen Barcellona/Painted steel	
	D30151C785	Cat.C Polipropilene Amburgo/Acciaio verniciato Cat.C Polypropylene Amburgo/Painted steel	
	D30151C803	Cat.D misto Lana vergine, Cotone, Poliammide Malmö/Acciaio verniciato Cat.D mixed virgin Wool, Cotton, Polyamide Malmö/Painted steel	3.200,00
	D30151C812	Cat.E Lana Divina Melange Kvadrat/Acciaio verniciato Cat.E Wool Divina Melange Kvadrat/Painted steel	
<div style="border: 1px solid black; width: 60px; height: 30px; display: inline-block;"></div> <p>Codice campione Sample code</p> <p>Campionario nr. Sample box n.</p> <p>ND/NA</p>	D30151C821	Cat.E Cotone Venezia/Acciaio verniciato Cat.E Cotton Venezia/Painted steel	3.900,00

ELISA
by Enzo Mari
2015

Divani

Struttura realizzata in acciaio verniciato a polveri poliestere black-brown, cuscini in schiuma poliuretana a densità variabile e fibra di poliestere, con rivestimento in tessuto sfoderabile. Uso solo interno.

Sofas

Structure made of steel finished in black-brown polyester paint, cushions in polyurethane foam of varying density and polyester fiber with removable fabric covering. Indoor use only.

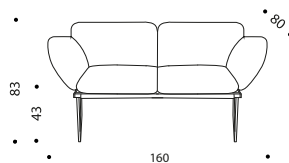

Divano 2 posti/
Two-seater sofa

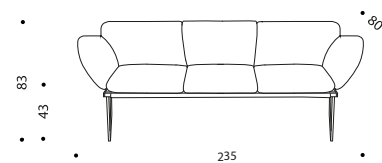

Divano 3 posti/
Three-seater sofa

Codice campione
Sample code
VERD4701

Campionario nr.
Sample box n.
7

PER LA SCELTA DEI TESSUTI E PELLI CONSULTARE IL
LIBRO "ABBINAMENTO TESSUTI-PELLI/MATERIALI"

FOR THE CHOICE OF FABRICS AND LEATHERS, SEE
BOOK "MATCHING FABRICS-LEATHERS/MATERIALS"

ELISA by Enzo Mari, 2015

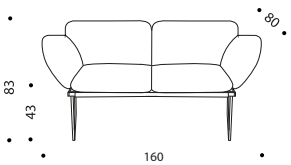
Modello Model	Codice Code	Categoria materiale - Descrizione materiale Material category - Material description	Prezzo Retail con Iva Retail price with Vat
Divano 2 posti L. 160 P. 80 H. 83; seduta H. 43; P.L. 48,5 Kg; V. 1,284 mc Two-seater sofa W. 160 D. 80 H. 83; seat H. 43; G.W. 48,5 Kg; V. 1,284 cbm	D10605C722	Cat.A Cotone Bonifacio/Acciaio verniciato <i>Cat.A Cotton Bonifacio/Painted steel</i>	4.100,00
	D10605C731	Cat.A Poliestere Marsiglia/Acciaio verniciato <i>Cat.A Polyester Marsiglia/Painted steel</i>	
	D10605C740	Cat.A misto Poliestere, Acrilico, Cotone Petra/Acciaio verniciato <i>Cat.A mixed Polyester, Acrylic, Cotton Petra/Painted steel</i>	
	D10605C749	Cat.A misto Poliestere, Acrilico, Cotone Damasco/Acciaio verniciato <i>Cat.A mixed Polyester, Acrylic, Cotton Damasco/Painted steel</i>	
	D10605C758	Cat.B misto Poliestere, Acrilico, Cotone Berlino/Acciaio verniciato <i>Cat.B mixed Polyester, Acrylic, Cotton Berlino/Painted steel</i>	4.450,00
	D10605C767	Cat.B Poliestere Jakarta/Acciaio verniciato <i>Cat.B Polyester Jakarta/Painted steel</i>	
	D10605C776	Cat.B Poliestere Ginevra/Acciaio verniciato <i>Cat.B Polyester Ginevra/Painted steel</i>	
	D10605C130	Cat.C Velluto di cotone Loira/Acciaio verniciato <i>Cat.C cotton Velvet Loira/Painted steel</i>	4.500,00
	D10605C134	Cat.C misto Lino, Cotone, Viscosa Lisbona/Acciaio verniciato <i>Cat.C mixed Linen, Cotton, Viscose Lisbona/Painted steel</i>	
	D10605C138	Cat.C Lino Barcellona/Acciaio verniciato <i>Cat.C Linen Barcellona/Painted steel</i>	
D10605C785	Cat.C Polipropilene Amburgo/Acciaio verniciato <i>Cat.C Polypropylene Amburgo/Painted steel</i>		
D10605C794	Cat.C misto Poliestere, Acrilico, Cotone, Lana, Viscosa Berna/Acc. verniciato <i>Cat.C mixed Polyester, Acrylic, Cotton, Wool, Viscose Berna/Painted steel</i>	5.300,00	
D10605C803	Cat.D misto Lana vergine, Cotone, Poliammide Malmö/Acciaio verniciato <i>Cat.D mixed Virgin Wool, Cotton, Polyamide Malmö/Painted steel</i>		
D10605C812	Cat.E Lana Divina Melange Kvadrat/Acciaio verniciato <i>Cat.E Wool Divina Melange Kvadrat/Painted steel</i>		
	D10605C821	Cat.E Cotone Venezia/Acciaio verniciato <i>Cat.E Cotton Venezia/Painted steel</i>	5.600,00
	D10605C148	Cat.P Pelle Niagara/Acciaio verniciato <i>Cat.P Leather Niagara/Painted steel</i>	5.500,00
	D10605C147	Cat.O Pelle Rio/Acciaio verniciato <i>Cat.O Leather Rio/Painted steel</i>	5.950,00
	D10605C150	Cat.ZME Pelle Amur/Acciaio verniciato <i>Cat.ZME Leather Amur/Painted steel</i>	6.200,00
	D10605C152	Cat.ZA Pelle Purus/Acciaio verniciato <i>Cat.ZA Leather Purus/Painted steel</i>	6.500,00
	D10605C149	Cat.ZC Pelle Churchill/Acciaio verniciato <i>Cat.ZC Leather Churchill/Painted steel</i>	7.300,00

PER LA SCELTA DEI TESSUTI E PELLI CONSULTARE IL LIBRO "ABBINAMENTO TESSUTI-PELLI/MATERIALI"

FOR THE CHOICE OF FABRICS AND LEATHERS, SEE BOOK "MATCHING FABRICS-LEATHERS/MATERIALS"

ELISA by Enzo Mari, 2015

Modello Model	Codice Code	Categoria materiale - Descrizione materiale Material category - Material description	Prezzo Retail con Iva Retail price with Vat	
Divano 3 posti L. 235 P. 80 H. 83; Seduta H. 43; P.L. 50 Kg; V. 1,90 mc Three-seater sofa W. 235 D. 80 H. 83; Seat H. 43; G.W. 50 Kg; V. 1,90 cbm	D10606C722	Cat.A Cotone Bonifacio/Acciaio verniciato <i>Cat.A Cotton Bonifacio/Painted steel</i>	5.450,00	
	D10606C731	Cat.A Poliestere Marsiglia/Acciaio verniciato <i>Cat.A Polyester Marsiglia/Painted steel</i>		
	D10606C740	Cat.A misto Poliestere, Acrilico, Cotone Petra/Acciaio verniciato <i>Cat.A mixed Polyester, Acrylic, Cotton Petra/Painted steel</i>		
	D10606C749	Cat.A misto Poliestere, Acrilico, Cotone Damasco/Acciaio verniciato <i>Cat.A mixed Polyester, Acrylic, Cotton Damasco/Painted steel</i>		
	D10606C758	Cat.B misto Poliestere, Acrilico, Cotone Berlino/Acciaio verniciato <i>Cat.B mixed Polyester, Acrylic, Cotton Berlino/Painted steel</i>	5.800,00	
	D10606C767	Cat.B Poliestere Jakarta/Acciaio verniciato <i>Cat.B Polyester Jakarta/Painted steel</i>		
	D10606C776	Cat.B Poliestere Ginevra/Acciaio verniciato <i>Cat.B Polyester Ginevra/Painted steel</i>		
	D10606C130	Cat.C Velluto di cotone Loira/Acciaio verniciato <i>Cat.C cotton Velvet Loira/Painted steel</i>	5.850,00	
	D10606C134	Cat.C misto Lino, Cotone, Viscosa Lisbona/Acciaio verniciato <i>Cat.C mixed Linen, Cotton, Viscose Lisbona/Painted steel</i>		
	D10606C138	Cat.C Lino Barcellona/Acciaio verniciato <i>Cat.C Linen Barcellona/Painted steel</i>		
	D10606C785	Cat.C Polipropilene Amburgo/Acciaio verniciato <i>Cat.C Polypropylene Amburgo/Painted steel</i>		
	D10606C794	Cat.C misto Poliestere, Acrilico, Cotone, Lana, Viscosa Berna/Acc. verniciato <i>Cat.C mixed Polyester, Acrylic, Cotton, Wool, Viscose Berna/Painted steel</i>		
	D10606C803	Cat.D misto Lana vergine, Cotone, Poliammide Malmö/Acciaio verniciato <i>Cat.D mixed Virgin Wool, Cotton, Polyamide Malmö/Painted steel</i>		6.900,00
	D10606C812	Cat.E Lana Divina Melange Kvadrat/Acciaio verniciato <i>Cat.E Wool Divina Melange Kvadrat/Painted steel</i>		
D10606C821	Cat.E Cotone Venezia/Acciaio verniciato <i>Cat.E Cotton Venezia/Painted steel</i>	7.300,00		
D10606C148	Cat.P Pelle Niagara/Acciaio verniciato <i>Cat.P Leather Niagara/Painted steel</i>			
D10606C147	Cat.O Pelle Rio/Acciaio verniciato <i>Cat.O Leather Rio/Painted steel</i>	7.800,00		
D10606C150	Cat.ZME Pelle Amur/Acciaio verniciato <i>Cat.ZME Leather Amur/Painted steel</i>	8.150,00		
D10606C152	Cat.ZA Pelle Purus/Acciaio verniciato <i>Cat.ZA Leather Purus/Painted steel</i>	8.700,00		
D10606C149	Cat.ZC Pelle Churchill/Acciaio verniciato <i>Cat.ZC Leather Churchill/Painted steel</i>	9.850,00		

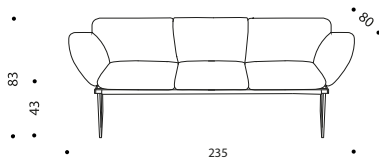

PER LA SCELTA DEI TESSUTI E PELLI CONSULTARE IL LIBRO "ABBINAMENTO TESSUTI-PELLI/MATERIALI"

FOR THE CHOICE OF FABRICS AND LEATHERS, SEE BOOK "MATCHING FABRICS-LEATHERS/MATERIALS"

FENIX
by Ludovica+Roberto
Palomba
2016

Divani componibili

Struttura metallica di base in tubolare di acciaio e cinghiatura elastica, piedi in trafilato di acciaio il tutto verniciato a polveri poliestere nel colore peltro bronzato. Schienali in multistrato di legno sagomati a "saponetta". Imbottitura degli schienali e dei cuscini di seduta in gomme poliuretaniche e piuma d'oca, rivestimento sfoderabile in tessuto o pelle. Ogni codice identifica il prodotto completo rivestito con un'unica variante di tessuto o pelle. La struttura, la cinghiatura elastica e la cuscineria possono anche essere rivestiti con diverse varianti di tessuto o pelle, prezzo su richiesta. Uso solo interno.

Sectional sofa

Sofa with modular elements made of a metal base structure in tubular steel and elastic belts, feet in drawn steel all painted with polyester powders in bronzed pewter color. Back panels in wood plywood soap-shaped. Padding of seatbacks and seat cushions in polyurethane and goose down rubbers, removable covers in fabric or leather. Each code identifies the complete product coated with a single variant of fabric or leather. The structure, the elastic belts and the cushions can be ordered in different variants of fabric or leather, price upon request. Indoor use only.

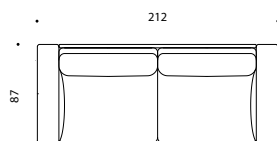

Divano 2 posti/
Two-seater sofa

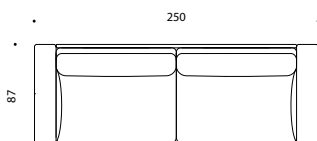

Divano 3 posti/
Three-seater sofa

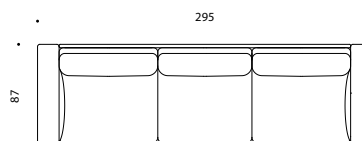

Divano 4 posti/
Four-seater sofa

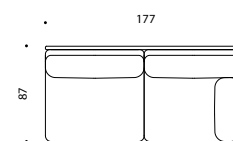

Elemento angolare destro/
Right corner element

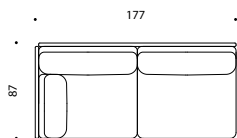

Elemento angolare sinistro/
Left corner element

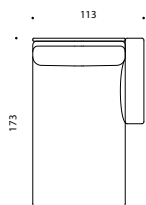

Dormeuse con bracciolo destro/
Daybed with right armrest

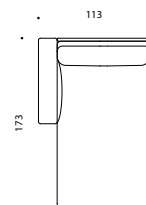

Dormeuse con bracciolo sinistro/
Daybed with left armrest

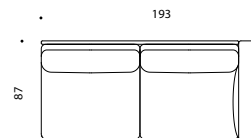

Elemento terminale destro L. 193/
Closing right element w. 193

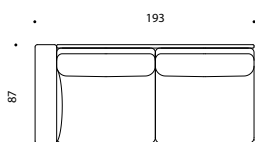

Elemento terminale sinistro L. 193/
Closing left element w. 193

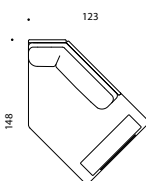

Isola piccola destra/
Small right ottoman

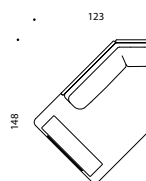

Isola piccola sinistra/
Small left ottoman

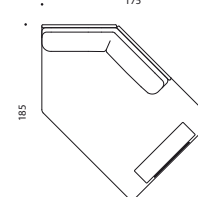

Isola grande destra/
Large right ottoman

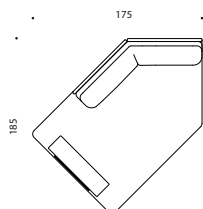

Isola grande sinistra/
Large left ottoman

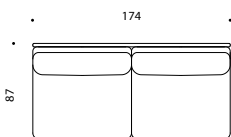

Elemento centrale/
Central element

Codice campione
Sample code
VERD4701

Campionario nr.
Sample box n.
7

FENIX by Ludovica + Roberto Palomba, 2018

Modello Model	Codice Code	Categoria materiale - Descrizione materiale Material category - Material description	Prezzo Retail con Iva Retail price with Vat
Divano 2 posti L. 212 P. 87 H. 75; seduta H. 44; P.L. 60 Kg; V. 1,512 mc Two-seater sofa W. 212 D. 87 H. 75; seat H. 44; G.W. 60 Kg; V. 1,512 cbm	D40015C722	Cat.A Cotone Bonifacio/Acciaio verniciato <i>Cat.A Cotton Bonifacio/Painted steel</i>	6.250,00
	D40015C731	Cat.A Poliestere Marsiglia/Acciaio verniciato <i>Cat.A Polyester Marsiglia/Painted steel</i>	
	D40015C740	Cat.A misto Poliestere, Acrilico, Cotone Petra/Acciaio verniciato <i>Cat.A mixed Polyester, Acrylic, Cotton Petra/Painted steel</i>	
	D40015C749	Cat.A misto Poliestere, Acrilico, Cotone Damasco/Acciaio verniciato <i>Cat.A mixed Polyester, Acrylic, Cotton Damasco/Painted steel</i>	
	D40015C129	Cat.A Ecopelle Colorado/Acciaio verniciato <i>Cat.A Eco-leather Colorado/Painted steel</i>	
	D40015C758	Cat.B misto Poliestere, Acrilico, Cotone Berlino/Acciaio verniciato <i>Cat.B mixed Polyester, Acrylic, Cotton Berlino/Painted steel</i>	6.650,00
	D40015C767	Cat.B Poliestere Jakarta/Acciaio verniciato <i>Cat.B Polyester Jakarta/Painted steel</i>	
	D40015C776	Cat.B Poliestere Ginevra/Acciaio verniciato <i>Cat.B Polyester Ginevra/Painted steel</i>	
	D40015C130	Cat.C Velluto di cotone Loira/Acciaio verniciato <i>Cat.C cotton Velvet Loira/Painted steel</i>	6.950,00
	D40015C134	Cat.C misto Lino, Cotone, Viscosa Lisbona/Acciaio verniciato <i>Cat.C mixed Linen, Cotton, Viscose Lisbona/Painted steel</i>	
	D40015C138	Cat.C Lino Barcellona/ Acciaio verniciato <i>Cat.C Linen Barcellona/Painted steel</i>	
	D40015C785	Cat.C Polipropilene Amburgo/ Acciaio verniciato <i>Cat.C Polypropylene Am burgo/Painted steel</i>	
	D40015C803	Cat.D misto Lana vergine, Cotone, Poliammide Malmö/Acciaio verniciato <i>Cat.D mixed virgin Wool, Cotton, Polyamide Malmö/Painted steel</i>	7.450,00
	D40015C812	Cat.E Lana Divina Melange Kvadrat/Acciaio verniciato <i>Cat.E Wool Divina Melange Kvadrat/Painted steel</i>	9.200,00
	D40015C821	Cat.E Cotone Venezia/Acciaio verniciato <i>Cat.E Cotton Venezia/Painted steel</i>	
	D40015C148	Cat.P Pelle Niagara/Acciaio verniciato <i>Cat.P Leather Niagara/Painted steel</i>	9.100,00
D40015C147	Cat.O Pelle Rio/Acciaio verniciato <i>Cat.O Leather Rio/Painted steel</i>	10.350,00	
D40015C150	Cat.ZME Pelle Amur/Acciaio verniciato <i>Cat.ZME Leather Amur/Painted steel</i>	11.600,00	
D40015C152	Cat.ZA Pelle Purus/Acciaio verniciato <i>Cat.ZA Leather Purus/Painted steel</i>	12.500,00	
D40015C149	Cat.ZC Pelle Churchill/Acciaio verniciato <i>Cat.ZC Leather Churchill/Painted steel</i>	13.700,00	

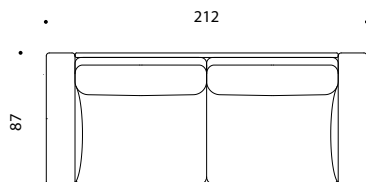

PER LA SCELTA DEI TESSUTI E PELLI CONSULTARE IL LIBRO "ABBINAMENTO TESSUTI-PELLI/MATERIALI"

FOR THE CHOICE OF FABRICS AND LEATHERS, SEE BOOK "MATCHING FABRICS-LEATHERS/MATERIALS"

Ogni codice identifica il prodotto completo rivestito con un'unica variante di tessuto o pelle. La struttura, la cinghiatura elastica e la cuscineria possono anche essere rivestiti con diverse varianti di tessuto o pelle, prezzo su richiesta.

Each code identifies the complete product coated with a single variant of fabric or leather. The structure, the elastic belts and the cushions can be ordered in different variants of fabric or leather, price upon request.

FENIX by Ludovica + Roberto Palomba, 2018

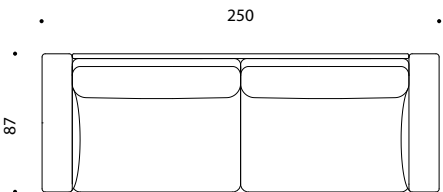
Modello Model	Codice Code	Categoria materiale - Descrizione materiale Material category - Material description	Prezzo Retail con Iva Retail price with Vat
Divano 3 posti L. 250 P. 87 H. 75; seduta H. 44; P.L. 90 Kg; V. 2,256 mc Three-seater sofa W. 250 D. 87 H. 75; seat H. 44; G.W. 90 Kg; V. 2,256 cbm	D40016C722	Cat.A Cotone Bonifacio/Acciaio verniciato <i>Cat.A Cotton Bonifacio/Painted steel</i>	7.150,00
	D40016C731	Cat.A Poliestere Marsiglia/Acciaio verniciato <i>Cat.A Polyester Marsiglia/Painted steel</i>	
	D40016C740	Cat.A misto Poliestere, Acrilico, Cotone Petra/Acciaio verniciato <i>Cat.A mixed Polyester, Acrylic, Cotton Petra/Painted steel</i>	
	D40016C749	Cat.A misto Poliestere, Acrilico, Cotone Damasco/Acciaio verniciato <i>Cat.A mixed Polyester, Acrylic, Cotton Damasco/Painted steel</i>	
	D40016C129	Cat.A Ecopelle Colorado/Acciaio verniciato <i>Cat.A Eco-leather Colorado/Painted steel</i>	
	D40016C758	Cat.B misto Poliestere, Acrilico, Cotone Berlino/Acciaio verniciato <i>Cat.B mixed Polyester, Acrylic, Cotton Berlino/Painted steel</i>	7.650,00
	D40016C767	Cat.B Poliestere Jakarta/Acciaio verniciato <i>Cat.B Polyester Jakarta/Painted steel</i>	
	D40016C776	Cat.B Poliestere Ginevra/Acciaio verniciato <i>Cat.B Polyester Ginevra/Painted steel</i>	
	D40016C130	Cat.C Velluto di cotone Loira/Acciaio verniciato <i>Cat.C cotton Velvet Loira/Painted steel</i>	7.900,00
<p>PER LA SCELTA DEI TESSUTI E PELLI CONSULTARE IL LIBRO "ABBINAMENTO TESSUTI-PELLI/MATERIALI"</p> <p>FOR THE CHOICE OF FABRICS AND LEATHERS, SEE BOOK "MATCHING FABRICS-LEATHERS/MATERIALS"</p> <p>Ogni codice identifica il prodotto completo rivestito con un'unica variante di tessuto o pelle. La struttura, la cinghiatura elastica e la cuscineria possono anche essere rivestiti con diverse varianti di tessuto o pelle, prezzo su richiesta. <i>Each code identifies the complete product coated with a single variant of fabric or leather. The structure, the elastic belts and the cushions can be ordered in different variants of fabric or leather, price upon request.</i></p>	D40016C134	Cat.C misto Lino, Cotone, Viscosa Lisbona/Acciaio verniciato <i>Cat.C mixed Linen, Cotton, Viscose Lisbona/Painted steel</i>	
	D40016C138	Cat.C Lino Barcellona/ Acciaio verniciato <i>Cat.C Linen Barcellona/Painted steel</i>	
	D40016C785	Cat.C Polipropilene Amburgo/ Acciaio verniciato <i>Cat.C Polypropylene Am burgo/Painted steel</i>	
	D40016C803	Cat.D misto Lana vergine, Cotone, Poliammide Malmö/Acciaio verniciato <i>Cat.D mixed virgin Wool, Cotton, Polyamide Malmö/Painted steel</i>	8.500,00
<p>PER LA SCELTA DEI TESSUTI E PELLI CONSULTARE IL LIBRO "ABBINAMENTO TESSUTI-PELLI/MATERIALI"</p> <p>FOR THE CHOICE OF FABRICS AND LEATHERS, SEE BOOK "MATCHING FABRICS-LEATHERS/MATERIALS"</p>	D40016C812	Cat.E Lana Divina Melange Kvadrat/Acciaio verniciato <i>Cat.E Wool Divina Melange Kvadrat/Painted steel</i>	9.900,00
	D40016C821	Cat.E Cotone Venezia/Acciaio verniciato <i>Cat.E Cotton Venezia/Painted steel</i>	
	D40016C148	Cat.P Pelle Niagara/Acciaio verniciato <i>Cat.P Leather Niagara/Painted steel</i>	10.000,00
	D40016C147	Cat.O Pelle Rio/Acciaio verniciato <i>Cat.O Leather Rio/Painted steel</i>	11.200,00
<p>PER LA SCELTA DEI TESSUTI E PELLI CONSULTARE IL LIBRO "ABBINAMENTO TESSUTI-PELLI/MATERIALI"</p> <p>FOR THE CHOICE OF FABRICS AND LEATHERS, SEE BOOK "MATCHING FABRICS-LEATHERS/MATERIALS"</p>	D40016C150	Cat.ZME Pelle Amur/Acciaio verniciato <i>Cat.ZME Leather Amur/Painted steel</i>	12.400,00
	D40016C152	Cat.ZA Pelle Purus/Acciaio verniciato <i>Cat.ZA Leather Purus/Painted steel</i>	13.400,00
	D40016C149	Cat.ZC Pelle Churchill/Acciaio verniciato <i>Cat.ZC Leather Churchill/Painted steel</i>	15.700,00

FENIX by Ludovica + Roberto Palomba, 2018

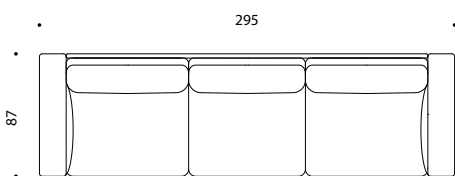
Modello Model	Codice Code	Categoria materiale - Descrizione materiale Material category - Material description	Prezzo Retail con Iva Retail price with Vat
Divano 4 posti L. 295 P. 87 H. 75; seduta H. 44; P.L. 100 Kg; V. 2,074 mc Four-seater sofa W. 295 D. 87 H. 75; seat H. 44; G.W. 100 Kg; V. 2,074 cbm	D40019C722	Cat.A Cotone Bonifacio/Acciaio verniciato <i>Cat.A Cotton Bonifacio/Painted steel</i>	7.900,00
	D40019C731	Cat.A Poliestere Marsiglia/Acciaio verniciato <i>Cat.A Polyester Marsiglia/Painted steel</i>	
	D40019C740	Cat.A misto Poliestere, Acrilico, Cotone Petra/Acciaio verniciato <i>Cat.A mixed Polyester, Acrylic, Cotton Petra/Painted steel</i>	
	D40019C749	Cat.A misto Poliestere, Acrilico, Cotone Damasco/Acciaio verniciato <i>Cat.A mixed Polyester, Acrylic, Cotton Damasco/Painted steel</i>	
	D40019C129	Cat.A Ecopelle Colorado/Acciaio verniciato <i>Cat.A Eco-leather Colorado/Painted steel</i>	
	D40019C758	Cat.B misto Poliestere, Acrilico, Cotone Berlino/Acciaio verniciato <i>Cat.B mixed Polyester, Acrylic, Cotton Berlino/Painted steel</i>	8.150,00
	D40019C767	Cat.B Poliestere Jakarta/Acciaio verniciato <i>Cat.B Polyester Jakarta/Painted steel</i>	
	D40019C776	Cat.B Poliestere Ginevra/Acciaio verniciato <i>Cat.B Polyester Ginevra/Painted steel</i>	
	D40019C130	Cat.C Velluto di cotone Loira/Acciaio verniciato <i>Cat.C cotton Velvet Loira/Painted steel</i>	8.500,00
	D40019C134	Cat.C misto Lino, Cotone, Viscosa Lisbona/Acciaio verniciato <i>Cat.C mixed Linen, Cotton, Viscose Lisbona/Painted steel</i>	
	D40019C138	Cat.C Lino Barcellona/ Acciaio verniciato <i>Cat.C Linen Barcellona/Painted steel</i>	
	D40019C785	Cat.C Polipropilene Amburgo/ Acciaio verniciato <i>Cat.C Polypropylene Am burgo/Painted steel</i>	
	D40019C803	Cat.D misto Lana vergine, Cotone, Poliammide Malmö/Acciaio verniciato <i>Cat.D mixed virgin Wool, Cotton, Polyamide Malmö/Painted steel</i>	9.150,00
	D40019C812	Cat.E Lana Divina Melange Kvadrat/Acciaio verniciato <i>Cat.E Wool Divina Melange Kvadrat/Painted steel</i>	11.500,00
	D40019C821	Cat.E Cotone Venezia/Acciaio verniciato <i>Cat.E Cotton Venezia/Painted steel</i>	
	D40019C148	Cat.P Pelle Niagara/Acciaio verniciato <i>Cat.P Leather Niagara/Painted steel</i>	11.350,00
	D40019C147	Cat.O Pelle Rio/Acciaio verniciato <i>Cat.O Leather Rio/Painted steel</i>	12.450,00
	D40019C150	Cat.ZME Pelle Amur/Acciaio verniciato <i>Cat.ZME Leather Amur/Painted steel</i>	13.650,00
	D40019C152	Cat.ZA Pelle Purus/Acciaio verniciato <i>Cat.ZA Leather Purus/Painted steel</i>	14.850,00
	D40019C149	Cat.ZC Pelle Churchill/Acciaio verniciato <i>Cat.ZC Leather Churchill/Painted steel</i>	16.950,00

PER LA SCELTA DEI TESSUTI E PELLI CONSULTARE IL LIBRO "ABBINAMENTO TESSUTI-PELLI/MATERIALI"

FOR THE CHOICE OF FABRICS AND LEATHERS, SEE BOOK "MATCHING FABRICS-LEATHERS/MATERIALS"

Ogni codice identifica il prodotto completo rivestito con un'unica variante di tessuto o pelle. La struttura, la cinghiera elastica e la cuscineria possono anche essere rivestiti con diverse varianti di tessuto o pelle, prezzo su richiesta.

Each code identifies the complete product coated with a single variant of fabric or leather. The structure, the elastic belts and the cushions can be ordered in different variants of fabric or leather, price upon request.

FENIX by Ludovica + Roberto Palomba, 2018

Modello Model	Codice Code	Categoria materiale - Descrizione materiale Material category - Material description	Prezzo Retail con Iva Retail price with Vat
Elemento angolare destro L. 177 P. 87 H. 75; seduta H. 44; P.L. 60 Kg; V. 1,170 mc Right corner element W. 177 D. 87 H. 75; seat H. 44; G.W. 60 Kg; V. 1,170 cbm	D40047D722	Cat.A Cotone Bonifacio/Acciaio verniciato <i>Cat.A Cotton Bonifacio/Painted steel</i>	5.650,00
	D40047D731	Cat.A Poliestere Marsiglia/Acciaio verniciato <i>Cat.A Polyester Marsiglia/Painted steel</i>	
	D40047D740	Cat.A misto Poliestere, Acrilico, Cotone Petra/Acciaio verniciato <i>Cat.A mixed Polyester, Acrylic, Cotton Petra/Painted steel</i>	
	D40047D749	Cat.A misto Poliestere, Acrilico, Cotone Damasco/Acciaio verniciato <i>Cat.A mixed Polyester, Acrylic, Cotton Damasco/Painted steel</i>	
	D40047D129	Cat.A Ecopelle Colorado/Acciaio verniciato <i>Cat.A Eco-leather Colorado/Painted steel</i>	
	D40047D758	Cat.B misto Poliestere, Acrilico, Cotone Berlino/Acciaio verniciato <i>Cat.B mixed Polyester, Acrylic, Cotton Berlino/Painted steel</i>	6.000,00
	D40047D767	Cat.B Poliestere Jakarta/Acciaio verniciato <i>Cat.B Polyester Jakarta/Painted steel</i>	
	D40047D776	Cat.B Poliestere Ginevra/Acciaio verniciato <i>Cat.B Polyester Ginevra/Painted steel</i>	
	D40047D130	Cat.C Velluto di cotone Loira/Acciaio verniciato <i>Cat.C cotton Velvet Loira/Painted steel</i>	6.250,00
	D40047D134	Cat.C misto Lino, Cotone, Viscosa Lisbona/Acciaio verniciato <i>Cat.C mixed Linen, Cotton, Viscose Lisbona/Painted steel</i>	
D40047D138	Cat.C Lino Barcellona/ Acciaio verniciato <i>Cat.C Linen Barcellona/Painted steel</i>		
D40047D785	Cat.C Polipropilene Amburgo/ Acciaio verniciato <i>Cat.C Polypropylene Am burgo/Painted steel</i>		
D40047D803	Cat.D misto Lana vergine, Cotone, Poliammide Malmö/Acciaio verniciato <i>Cat.D mixed virgin Wool, Cotton, Polyamide Malmö/Painted steel</i>	6.500,00	
D40047D812	Cat.E Lana Divina Melange Kvadrat/Acciaio verniciato <i>Cat.E Wool Divina Melange Kvadrat/Painted steel</i>	7.700,00	
D40047D821	Cat.E Cotone Venezia/Acciaio verniciato <i>Cat.E Cotton Venezia/Painted steel</i>		
D40047D148	Cat.P Pelle Niagara/Acciaio verniciato <i>Cat.P Leather Niagara/Painted steel</i>	7.600,00	
D40047D147	Cat.O Pelle Rio/Acciaio verniciato <i>Cat.O Leather Rio/Painted steel</i>	7.950,00	
D40047D150	Cat.ZME Pelle Amur/Acciaio verniciato <i>Cat.ZME Leather Amur/Painted steel</i>	8.750,00	
D40047D152	Cat.ZA Pelle Purus/Acciaio verniciato <i>Cat.ZA Leather Purus/Painted steel</i>	9.200,00	
D40047D149	Cat.ZC Pelle Churchill/Acciaio verniciato <i>Cat.ZC Leather Churchill/Painted steel</i>	10.650,00	

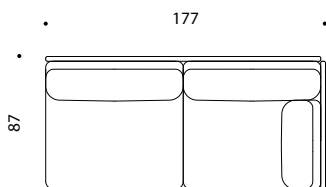

PER LA SCELTA DEI TESSUTI E PELLI CONSULTARE IL LIBRO "ABBINAMENTO TESSUTI-PELLI/MATERIALI"

FOR THE CHOICE OF FABRICS AND LEATHERS, SEE BOOK "MATCHING FABRICS-LEATHERS/MATERIALS"

Ogni codice identifica il prodotto completo rivestito con un'unica variante di tessuto o pelle. La struttura, la cinghiatura elastica e la cuscineria possono anche essere rivestiti con diverse varianti di tessuto o pelle, prezzo su richiesta.

Each code identifies the complete product coated with a single variant of fabric or leather. The structure, the elastic belts and the cushions can be ordered in different variants of fabric or leather, price upon request.

FENIX by Ludovica + Roberto Palomba, 2018

Modello Model	Codice Code	Categoria materiale - Descrizione materiale Material category - Material description	Prezzo Retail con Iva Retail price with Vat
Elemento angolare sinistro L. 177 P. 87 H. 75; seduta H. 44; PL. 60 Kg; V. 1,170 mc Left corner element W. 177 D. 87 H. 75; seat H. 44; G.W. 60 Kg; V. 1,170 cbm	D40048D722	Cat.A Cotone Bonifacio/Acciaio verniciato <i>Cat.A Cotton Bonifacio/Painted steel</i>	5.650,00
	D40048D731	Cat.A Poliestere Marsiglia/Acciaio verniciato <i>Cat.A Polyester Marsiglia/Painted steel</i>	
	D40048D740	Cat.A misto Poliestere, Acrilico, Cotone Petra/Acciaio verniciato <i>Cat.A mixed Polyester, Acrylic, Cotton Petra/Painted steel</i>	
	D40048D749	Cat.A misto Poliestere, Acrilico, Cotone Damasco/Acciaio verniciato <i>Cat.A mixed Polyester, Acrylic, Cotton Damasco/Painted steel</i>	
	D40048D129	Cat.A Ecopelle Colorado/Acciaio verniciato <i>Cat.A Eco-leather Colorado/Painted steel</i>	
	D40048D758	Cat.B misto Poliestere, Acrilico, Cotone Berlino/Acciaio verniciato <i>Cat.B mixed Polyester, Acrylic, Cotton Berlino/Painted steel</i>	6.000,00
	D40048D767	Cat.B Poliestere Jakarta/Acciaio verniciato <i>Cat.B Polyester Jakarta/Painted steel</i>	
	D40048D776	Cat.B Poliestere Ginevra/Acciaio verniciato <i>Cat.B Polyester Ginevra/Painted steel</i>	
	D40048D130	Cat.C Velluto di cotone Loira/Acciaio verniciato <i>Cat.C cotton Velvet Loira/Painted steel</i>	6.250,00
	D40048D134	Cat.C misto Lino, Cotone, Viscosa Lisbona/Acciaio verniciato <i>Cat.C mixed Linen, Cotton, Viscose Lisbona/Painted steel</i>	
D40048D138	Cat.C Lino Barcellona/ Acciaio verniciato <i>Cat.C Linen Barcellona/Painted steel</i>		
D40048D785	Cat.C Polipropilene Amburgo/ Acciaio verniciato <i>Cat.C Polypropylene Am burgo/Painted steel</i>		
D40048D803	Cat.D misto Lana vergine, Cotone, Poliammide Malmö/Acciaio verniciato <i>Cat.D mixed virgin Wool, Cotton, Polyamide Malmö/Painted steel</i>	6.500,00	
D40048D812	Cat.E Lana Divina Melange Kvadrat/Acciaio verniciato <i>Cat.E Wool Divina Melange Kvadrat/Painted steel</i>	7.700,00	
D40048D821	Cat.E Cotone Venezia/Acciaio verniciato <i>Cat.E Cotton Venezia/Painted steel</i>		
D40048D148	Cat.P Pelle Niagara/Acciaio verniciato <i>Cat.P Leather Niagara/Painted steel</i>	7.600,00	
D40048D147	Cat.O Pelle Rio/Acciaio verniciato <i>Cat.O Leather Rio/Painted steel</i>	7.950,00	
D40048D150	Cat.ZME Pelle Amur/Acciaio verniciato <i>Cat.ZME Leather Amur/Painted steel</i>	8.750,00	
D40048D152	Cat.ZA Pelle Purus/Acciaio verniciato <i>Cat.ZA Leather Purus/Painted steel</i>	9.200,00	
D40048D149	Cat.ZC Pelle Churchill/Acciaio verniciato <i>Cat.ZC Leather Churchill/Painted steel</i>	10.650,00	

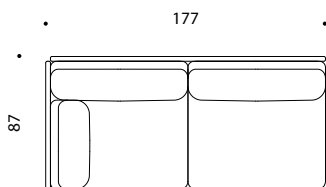

PER LA SCELTA DEI TESSUTI E PELLI CONSULTARE IL LIBRO "ABBINAMENTO TESSUTI-PELLI/MATERIALI"

FOR THE CHOICE OF FABRICS AND LEATHERS, SEE BOOK "MATCHING FABRICS-LEATHERS/MATERIALS"

Ogni codice identifica il prodotto completo rivestito con un'unica variante di tessuto o pelle. La struttura, la cinghiatura elastica e la cuscineria possono anche essere rivestiti con diverse varianti di tessuto o pelle, prezzo su richiesta.

Each code identifies the complete product coated with a single variant of fabric or leather. The structure, the elastic belts and the cushions can be ordered in different variants of fabric or leather, price upon request.

FENIX by Ludovica + Roberto Palomba, 2018

Modello Model	Codice Code	Categoria materiale - Descrizione materiale Material category - Material description	Prezzo Retail con Iva Retail price with Vat
Dormeuse con bracciolo destro L. 113 P. 175 H. 75; seduta H. 44; P.L. 60 Kg; V. 1.483 mc Daybed with right armrest W. 113 D. 175 H. 75; seat H. 44; G.W. 60 Kg; V. 1.483 cbm	D40273M722	Cat.A Cotone Bonifacio/Acciaio verniciato <i>Cat.A Cotton Bonifacio/Painted steel</i>	5.150,00
	D40273M731	Cat.A Poliestere Marsiglia/Acciaio verniciato <i>Cat.A Polyester Marsiglia/Painted steel</i>	
	D40273M740	Cat.A misto Poliestere, Acrilico, Cotone Petra/Acciaio verniciato <i>Cat.A mixed Polyester, Acrylic, Cotton Petra/Painted steel</i>	
	D40273M749	Cat.A misto Poliestere, Acrilico, Cotone Damasco/Acciaio verniciato <i>Cat.A mixed Polyester, Acrylic, Cotton Damasco/Painted steel</i>	
	D40273M129	Cat.A Ecopelle Colorado/Acciaio verniciato <i>Cat.A Eco-leather Colorado/Painted steel</i>	
	D40273M758	Cat.B misto Poliestere, Acrilico, Cotone Berlino/Acciaio verniciato <i>Cat.B mixed Polyester, Acrylic, Cotton Berlino/Painted steel</i>	5.400,00
	D40273M767	Cat.B Poliestere Jakarta/Acciaio verniciato <i>Cat.B Polyester Jakarta/Painted steel</i>	
	D40273M776	Cat.B Poliestere Ginevra/Acciaio verniciato <i>Cat.B Polyester Ginevra/Painted steel</i>	
	D40273M130	Cat.C Velluto di cotone Loira/Acciaio verniciato <i>Cat.C cotton Velvet Loira/Painted steel</i>	5.600,00
	D40273M134	Cat.C misto Lino, Cotone, Viscosa Lisbona/Acciaio verniciato <i>Cat.C mixed Linen, Cotton, Viscose Lisbona/Painted steel</i>	
D40273M138	Cat.C Lino Barcellona/ Acciaio verniciato <i>Cat.C Linen Barcellona/Painted steel</i>		
D40273M785	Cat.C Polipropilene Amburgo/ Acciaio verniciato <i>Cat.C Polypropylene Am burgo/Painted steel</i>		
D40273M803	Cat.D misto Lana vergine, Cotone, Poliammide Malmö/Acciaio verniciato <i>Cat.D mixed virgin Wool, Cotton, Polyamide Malmö/Painted steel</i>	6.000,00	
D40273M812	Cat.E Lana Divina Melange Kvadrat/Acciaio verniciato <i>Cat.E Wool Divina Melange Kvadrat/Painted steel</i>	6.900,00	
D40273M821	Cat.E Cotone Venezia/Acciaio verniciato <i>Cat.E Cotton Venezia/Painted steel</i>		
D40273M148	Cat.P Pelle Niagara/Acciaio verniciato <i>Cat.P Leather Niagara/Painted steel</i>	6.800,00	
D40273M147	Cat.O Pelle Rio/Acciaio verniciato <i>Cat.O Leather Rio/Painted steel</i>	7.900,00	
D40273M150	Cat.ZME Pelle Amur/Acciaio verniciato <i>Cat.ZME Leather Amur/Painted steel</i>	8.750,00	
D40273M152	Cat.ZA Pelle Purus/Acciaio verniciato <i>Cat.ZA Leather Purus/Painted steel</i>	9.250,00	
D40273M149	Cat.ZC Pelle Churchill/Acciaio verniciato <i>Cat.ZC Leather Churchill/Painted steel</i>	10.100,00	

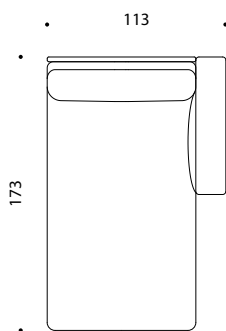

PER LA SCELTA DEI TESSUTI E PELLI CONSULTARE IL LIBRO "ABBINAMENTO TESSUTI-PELLI/MATERIALI"

FOR THE CHOICE OF FABRICS AND LEATHERS, SEE BOOK "MATCHING FABRICS-LEATHERS/MATERIALS"

Ogni codice identifica il prodotto completo rivestito con un'unica variante di tessuto o pelle. La struttura, la cinghiatura elastica e la cuscineria possono anche essere rivestiti con diverse varianti di tessuto o pelle, prezzo su richiesta.

Each code identifies the complete product coated with a single variant of fabric or leather. The structure, the elastic belts and the cushions can be ordered in different variants of fabric or leather, price upon request.

FENIX by Ludovica + Roberto Palomba, 2018

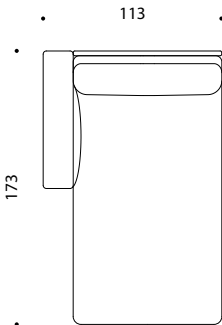
Modello Model	Codice Code	Categoria materiale - Descrizione materiale Material category - Material description	Prezzo Retail con Iva Retail price with Vat
Dormeuse con bracciolo sinistro L. 113 P. 175 H. 75; seduta H. 44; P.L. 60 Kg; V. 1.483 mc Daybed with left armrest W. 113 D. 175 H. 75; seat H. 44; G.W. 60 Kg; V. 1.483 cbm	D40274M722	Cat.A Cotone Bonifacio/Acciaio verniciato <i>Cat.A Cotton Bonifacio/Painted steel</i>	5.150,00
	D40274M731	Cat.A Poliestere Marsiglia/Acciaio verniciato <i>Cat.A Polyester Marsiglia/Painted steel</i>	
	D40274M740	Cat.A misto Poliestere, Acrilico, Cotone Petra/Acciaio verniciato <i>Cat.A mixed Polyester, Acrylic, Cotton Petra/Painted steel</i>	
	D40274M749	Cat.A misto Poliestere, Acrilico, Cotone Damasco/Acciaio verniciato <i>Cat.A mixed Polyester, Acrylic, Cotton Damasco/Painted steel</i>	
	D40274M129	Cat.A Ecopelle Colorado/Acciaio verniciato <i>Cat.A Eco-leather Colorado/Painted steel</i>	
	D40274M758	Cat.B misto Poliestere, Acrilico, Cotone Berlino/Acciaio verniciato <i>Cat.B mixed Polyester, Acrylic, Cotton Berlino/Painted steel</i>	5.400,00
	D40274M767	Cat.B Poliestere Jakarta/Acciaio verniciato <i>Cat.B Polyester Jakarta/Painted steel</i>	
	D40274M776	Cat.B Poliestere Ginevra/Acciaio verniciato <i>Cat.B Polyester Ginevra/Painted steel</i>	
	D40274M130	Cat.C Velluto di cotone Loira/Acciaio verniciato <i>Cat.C cotton Velvet Loira/Painted steel</i>	5.600,00
	D40274M134	Cat.C misto Lino, Cotone, Viscosa Lisbona/Acciaio verniciato <i>Cat.C mixed Linen, Cotton, Viscose Lisbona/Painted steel</i>	
	D40274M138	Cat.C Lino Barcellona/ Acciaio verniciato <i>Cat.C Linen Barcellona/Painted steel</i>	
	D40274M785	Cat.C Polipropilene Amburgo/ Acciaio verniciato <i>Cat.C Polypropylene Am burgo/Painted steel</i>	
	D40274M803	Cat.D misto Lana vergine, Cotone, Poliammide Malmö/Acciaio verniciato <i>Cat.D mixed virgin Wool, Cotton, Polyamide Malmö/Painted steel</i>	6.000,00
<p>PER LA SCELTA DEI TESSUTI E PELLI CONSULTARE IL LIBRO "ABBINAMENTO TESSUTI-PELLI/MATERIALI"</p> <p>FOR THE CHOICE OF FABRICS AND LEATHERS, SEE BOOK "MATCHING FABRICS-LEATHERS/MATERIALS"</p> <p>Ogni codice identifica il prodotto completo rivestito con un'unica variante di tessuto o pelle. La struttura, la cinghiatura elastica e la cuscineria possono anche essere rivestiti con diverse varianti di tessuto o pelle, prezzo su richiesta.</p> <p><i>Each code identifies the complete product coated with a single variant of fabric or leather. The structure, the elastic belts and the cushions can be ordered in different variants of fabric or leather, price upon request.</i></p>	D40274M812	Cat.E Lana Divina Melange Kvadrat/Acciaio verniciato <i>Cat.E Wool Divina Melange Kvadrat/Painted steel</i>	6.900,00
	D40274M821	Cat.E Cotone Venezia/Acciaio verniciato <i>Cat.E Cotton Venezia/Painted steel</i>	
	D40274M148	Cat.P Pelle Niagara/Acciaio verniciato <i>Cat.P Leather Niagara/Painted steel</i>	6.800,00
	D40274M147	Cat.O Pelle Rio/Acciaio verniciato <i>Cat.O Leather Rio/Painted steel</i>	7.900,00
	D40274M150	Cat.ZME Pelle Amur/Acciaio verniciato <i>Cat.ZME Leather Amur/Painted steel</i>	8.750,00
D40274M152	Cat.ZA Pelle Purus/Acciaio verniciato <i>Cat.ZA Leather Purus/Painted steel</i>	9.250,00	
D40274M149	Cat.ZC Pelle Churchill/Acciaio verniciato <i>Cat.ZC Leather Churchill/Painted steel</i>	10.100,00	

FENIX by Ludovica + Roberto Palomba, 2018

Modello Model	Codice Code	Categoria materiale - Descrizione materiale Material category - Material description	Prezzo Retail con Iva Retail price with Vat
Elemento terminale destro L. 193 L. 193 P. 87 H. 75; seduta H. 44; P.L. 60 Kg; V. 1,259 mc Closing right element W. 193 W. 193 D. 87 H. 75; seat H. 44; G.W.. 60 Kg; V. 1,259 cbm	D40141E722	Cat.A Cotone Bonifacio/Acciaio verniciato <i>Cat.A Cotton Bonifacio/Painted steel</i>	5.700,00
	D40141E731	Cat.A Poliestere Marsiglia/Acciaio verniciato <i>Cat.A Polyester Marsiglia/Painted steel</i>	
	D40141E740	Cat.A misto Poliestere, Acrilico, Cotone Petra/Acciaio verniciato <i>Cat.A mixed Polyester, Acrylic, Cotton Petra/Painted steel</i>	
	D40141E749	Cat.A misto Poliestere, Acrilico, Cotone Damasco/Acciaio verniciato <i>Cat.A mixed Polyester, Acrylic, Cotton Damasco/Painted steel</i>	
	D40141E129	Cat.A Ecopelle Colorado/Acciaio verniciato <i>Cat.A Eco-leather Colorado/Painted steel</i>	
	D40141E758	Cat.B misto Poliestere, Acrilico, Cotone Berlino/Acciaio verniciato <i>Cat.B mixed Polyester, Acrylic, Cotton Berlino/Painted steel</i>	6.100,00
	D40141E767	Cat.B Poliestere Jakarta/Acciaio verniciato <i>Cat.B Polyester Jakarta/Painted steel</i>	
	D40141E776	Cat.B Poliestere Ginevra/Acciaio verniciato <i>Cat.B Polyester Ginevra/Painted steel</i>	
	D40141E130	Cat.C Velluto di cotone Loira/Acciaio verniciato <i>Cat.C cotton Velvet Loira/Painted steel</i>	6.300,00
	D40141E134	Cat.C misto Lino, Cotone, Viscosa Lisbona/Acciaio verniciato <i>Cat.C mixed Linen, Cotton, Viscose Lisbona/Painted steel</i>	
D40141E138	Cat.C Lino Barcellona/ Acciaio verniciato <i>Cat.C Linen Barcellona/Painted steel</i>		
D40141E785	Cat.C Polipropilene Amburgo/ Acciaio verniciato <i>Cat.C Polypropylene Am burgo/Painted steel</i>		
D40141E803	Cat.D misto Lana vergine, Cotone, Poliammide Malmö/Acciaio verniciato <i>Cat.D mixed virgin Wool, Cotton, Polyamide Malmö/Painted steel</i>	6.800,00	
D40141E812	Cat.E Lana Divina Melange Kvadrat/Acciaio verniciato <i>Cat.E Wool Divina Melange Kvadrat/Painted steel</i>	7.700,00	
D40141E821	Cat.E Cotone Venezia/Acciaio verniciato <i>Cat.E Cotton Venezia/Painted steel</i>		
D40141E148	Cat.P Pelle Niagara/Acciaio verniciato <i>Cat.P Leather Niagara/Painted steel</i>	7.500,00	
D40141E147	Cat.O Pelle Rio/Acciaio verniciato <i>Cat.O Leather Rio/Painted steel</i>	8.500,00	
D40141E150	Cat.ZME Pelle Amur/Acciaio verniciato <i>Cat.ZME Leather Amur/Painted steel</i>	9.000,00	
D40141E152	Cat.ZA Pelle Purus/Acciaio verniciato <i>Cat.ZA Leather Purus/Painted steel</i>	9.500,00	
D40141E149	Cat.ZC Pelle Churchill/Acciaio verniciato <i>Cat.ZC Leather Churchill/Painted steel</i>	11.400,00	

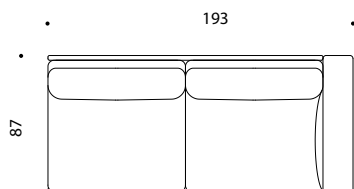

PER LA SCELTA DEI TESSUTI E PELLI CONSULTARE IL LIBRO "ABBINAMENTO TESSUTI-PELLI/MATERIALI"

FOR THE CHOICE OF FABRICS AND LEATHERS, SEE BOOK "MATCHING FABRICS-LEATHERS/MATERIALS"

Ogni codice identifica il prodotto completo rivestito con un'unica variante di tessuto o pelle. La struttura, la cinghiatura elastica e la cuscineria possono anche essere rivestiti con diverse varianti di tessuto o pelle, prezzo su richiesta.

Each code identifies the complete product coated with a single variant of fabric or leather. The structure, the elastic belts and the cushions can be ordered in different variants of fabric or leather, price upon request.

FENIX by Ludovica + Roberto Palomba, 2018

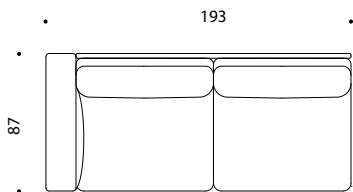
Modello Model	Codice Code	Categoria materiale - Descrizione materiale Material category - Material description	Prezzo Retail con Iva Retail price with Vat
<p>Elemento terminale sinistro L. 193 L. 193 P. 87 H. 75; seduta H. 44; P.L. 60 Kg; V. 1,259 mc</p> <p>Closing left element W. 193 W. 193 D. 87 H. 75; seat H. 44; G.W.. 60 Kg; V. 1,259 cbm</p> 	D40142E722	Cat.A Cotone Bonifacio/Acciaio verniciato <i>Cat.A Cotton Bonifacio/Painted steel</i>	5.700,00
	D40142E731	Cat.A Poliestere Marsiglia/Acciaio verniciato <i>Cat.A Polyester Marsiglia/Painted steel</i>	
	D40142E740	Cat.A misto Poliestere, Acrilico, Cotone Petra/Acciaio verniciato <i>Cat.A mixed Polyester, Acrylic, Cotton Petra/Painted steel</i>	
	D40142E749	Cat.A misto Poliestere, Acrilico, Cotone Damasco/Acciaio verniciato <i>Cat.A mixed Polyester, Acrylic, Cotton Damasco/Painted steel</i>	
	D40142E129	Cat.A Ecopelle Colorado/Acciaio verniciato <i>Cat.A Eco-leather Colorado/Painted steel</i>	
	D40142E758	Cat.B misto Poliestere, Acrilico, Cotone Berlino/Acciaio verniciato <i>Cat.B mixed Polyester, Acrylic, Cotton Berlino/Painted steel</i>	6.100,00
	D40142E767	Cat.B Poliestere Jakarta/Acciaio verniciato <i>Cat.B Polyester Jakarta/Painted steel</i>	
	D40142E776	Cat.B Poliestere Ginevra/Acciaio verniciato <i>Cat.B Polyester Ginevra/Painted steel</i>	
	D40142E130	Cat.C Velluto di cotone Loira/Acciaio verniciato <i>Cat.C cotton Velvet Loira/Painted steel</i>	6.300,00
	D40142E134	Cat.C misto Lino, Cotone, Viscosa Lisbona/Acciaio verniciato <i>Cat.C mixed Linen, Cotton, Viscose Lisbona/Painted steel</i>	
	D40142E138	Cat.C Lino Barcellona/ Acciaio verniciato <i>Cat.C Linen Barcellona/Painted steel</i>	
	D40142E785	Cat.C Polipropilene Amburgo/ Acciaio verniciato <i>Cat.C Polypropylene Am burgo/Painted steel</i>	
	D40142E803	Cat.D misto Lana vergine, Cotone, Poliammide Malmö/Acciaio verniciato <i>Cat.D mixed virgin Wool, Cotton, Polyamide Malmö/Painted steel</i>	6.800,00
	D40142E812	Cat.E Lana Divina Melange Kvadrat/Acciaio verniciato <i>Cat.E Wool Divina Melange Kvadrat/Painted steel</i>	7.700,00
	D40142E821	Cat.E Cotone Venezia/Acciaio verniciato <i>Cat.E Cotton Venezia/Painted steel</i>	
	D40142E148	Cat.P Pelle Niagara/Acciaio verniciato <i>Cat.P Leather Niagara/Painted steel</i>	7.500,00
D40142E147	Cat.O Pelle Rio/Acciaio verniciato <i>Cat.O Leather Rio/Painted steel</i>	8.500,00	
D40142E150	Cat.ZME Pelle Amur/Acciaio verniciato <i>Cat.ZME Leather Amur/Painted steel</i>	9.000,00	
D40142E152	Cat.ZA Pelle Purus/Acciaio verniciato <i>Cat.ZA Leather Purus/Painted steel</i>	9.500,00	
D40142E149	Cat.ZC Pelle Churchill/Acciaio verniciato <i>Cat.ZC Leather Churchill/Painted steel</i>	11.400,00	

PER LA SCELTA DEI TESSUTI E PELLI CONSULTARE IL LIBRO "ABBINAMENTO TESSUTI-PELLI/MATERIALI"

FOR THE CHOICE OF FABRICS AND LEATHERS, SEE BOOK "MATCHING FABRICS-LEATHERS/MATERIALS"

Ogni codice identifica il prodotto completo rivestito con un'unica variante di tessuto o pelle. La struttura, la cinghiatura elastica e la cuscineria possono anche essere rivestiti con diverse varianti di tessuto o pelle, prezzo su richiesta.

Each code identifies the complete product coated with a single variant of fabric or leather. The structure, the elastic belts and the cushions can be ordered in different variants of fabric or leather, price upon request.

FENIX by Ludovica + Roberto Palomba, 2018

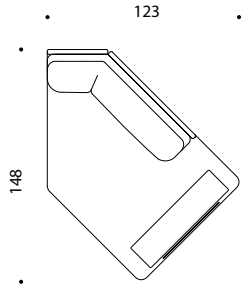
Modello Model	Codice Code	Categoria materiale - Descrizione materiale Material category - Material description	Prezzo Retail con Iva Retail price with Vat
Isola piccola destra L. 123 P. 148 H. 75; seduta H. 44; P.L. 60 Kg; V. 1,365 mc Small right ottoman W. 123 D. 148 H. 75; seat H. 44; G.W. 60 Kg; V. 1,365 cbm	D40183E722	Cat.A Cotone Bonifacio/Acciaio verniciato Cat.A Cotton Bonifacio/Painted steel	4.650,00
	D40183E731	Cat.A Poliestere Marsiglia/Acciaio verniciato Cat.A Polyester Marsiglia/Painted steel	
	D40183E740	Cat.A misto Poliestere, Acrilico, Cotone Petra/Acciaio verniciato Cat.A mixed Polyester, Acrylic, Cotton Petra/Painted steel	
	D40183E749	Cat.A misto Poliestere, Acrilico, Cotone Damasco/Acciaio verniciato Cat.A mixed Polyester, Acrylic, Cotton Damasco/Painted steel	
	D40183E129	Cat.A Ecopelle Colorado/Acciaio verniciato Cat.A Eco-leather Colorado/Painted steel	
	D40183E758	Cat.B misto Poliestere, Acrilico, Cotone Berlino/Acciaio verniciato Cat.B mixed Polyester, Acrylic, Cotton Berlino/Painted steel	5.150,00
	D40183E767	Cat.B Poliestere Jakarta/Acciaio verniciato Cat.B Polyester Jakarta/Painted steel	
	D40183E776	Cat.B Poliestere Ginevra/Acciaio verniciato Cat.B Polyester Ginevra/Painted steel	
	D40183E130	Cat.C Velluto di cotone Loira/Acciaio verniciato Cat.C cotton Velvet Loira/Painted steel	5.400,00
<p>PER LA SCELTA DEI TESSUTI E PELLI CONSULTARE IL LIBRO "ABBINAMENTO TESSUTI-PELLI/MATERIALI"</p> <p>FOR THE CHOICE OF FABRICS AND LEATHERS, SEE BOOK "MATCHING FABRICS-LEATHERS/MATERIALS"</p> <p>Ogni codice identifica il prodotto completo rivestito con un'unica variante di tessuto o pelle. La struttura, la cinghiatura elastica e la cuscineria possono anche essere rivestiti con diverse varianti di tessuto o pelle, prezzo su richiesta. Each code identifies the complete product coated with a single variant of fabric or leather. The structure, the elastic belts and the cushions can be ordered in different variants of fabric or leather, price upon request.</p>	D40183E134	Cat.C misto Lino, Cotone, Viscosa Lisbona/Acciaio verniciato Cat.C mixed Linen, Cotton, Viscose Lisbona/Painted steel	
	D40183E138	Cat.C Lino Barcellona/ Acciaio verniciato Cat.C Linen Barcellona/Painted steel	
	D40183E785	Cat.C Polipropilene Amburgo/ Acciaio verniciato Cat.C Polypropylene Am burgo/Painted steel	
	D40183E803	Cat.D misto Lana vergine, Cotone, Poliammide Malmö/ Acciaio verniciato Cat.D mixed virgin Wool, Cotton, Polyamide Malmö/Painted steel	5.800,00
	D40183E812	Cat.E Lana Divina Melange Kvadrat/Acciaio verniciato Cat.E Wool Divina Melange Kvadrat/Painted steel	6.700,00
	D40183E821	Cat.E Cotone Venezia/Acciaio verniciato Cat.E Cotton Venezia/Painted steel	
	D40183E148	Cat.P Pelle Niagara/Acciaio verniciato Cat.P Leather Niagara/Painted steel	6.600,00
	D40183E147	Cat.O Pelle Rio/Acciaio verniciato Cat.O Leather Rio/Painted steel	7.350,00
	D40183E150	Cat.ZME Pelle Amur/Acciaio verniciato Cat.ZME Leather Amur/Painted steel	8.100,00
	D40183E152	Cat.ZA Pelle Purus/Acciaio verniciato Cat.ZA Leather Purus/Painted steel	8.450,00
	D40183E149	Cat.ZC Pelle Churchill/Acciaio verniciato Cat.ZC Leather Churchill/Painted steel	9.800,00

FENIX by Ludovica + Roberto Palomba, 2018

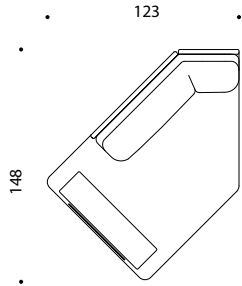
Modello Model	Codice Code	Categoria materiale - Descrizione materiale Material category - Material description	Prezzo Retail con Iva Retail price with Vat
Isola piccola sinistra L. 123 P. 148 H. 75; seduta H. 44; P.L. 60 Kg; V. 1,365 mc Small left ottoman W. 123 D. 148 H. 75; seat H. 44; G.W. 60 Kg; V. 1,365 cbm	D40184E722	Cat.A Cotone Bonifacio/Acciaio verniciato <i>Cat.A Cotton Bonifacio/Painted steel</i>	4.650,00
	D40184E731	Cat.A Poliestere Marsiglia/Acciaio verniciato <i>Cat.A Polyester Marsiglia/Painted steel</i>	
	D40184E740	Cat.A misto Poliestere, Acrilico, Cotone Petra/Acciaio verniciato <i>Cat.A mixed Polyester, Acrylic, Cotton Petra/Painted steel</i>	
	D40184E749	Cat.A misto Poliestere, Acrilico, Cotone Damasco/Acciaio verniciato <i>Cat.A mixed Polyester, Acrylic, Cotton Damasco/Painted steel</i>	
	D40184E129	Cat.A Ecopelle Colorado/Acciaio verniciato <i>Cat.A Eco-leather Colorado/Painted steel</i>	
	D40184E758	Cat.B misto Poliestere, Acrilico, Cotone Berlino/Acciaio verniciato <i>Cat.B mixed Polyester, Acrylic, Cotton Berlino/Painted steel</i>	5.150,00
	D40184E767	Cat.B Poliestere Jakarta/Acciaio verniciato <i>Cat.B Polyester Jakarta/Painted steel</i>	
	D40184E776	Cat.B Poliestere Ginevra/Acciaio verniciato <i>Cat.B Polyester Ginevra/Painted steel</i>	
	D40184E130	Cat.C Velluto di cotone Loira/Acciaio verniciato <i>Cat.C cotton Velvet Loira/Painted steel</i>	5.400,00
<p>PER LA SCELTA DEI TESSUTI E PELLI CONSULTARE IL LIBRO "ABBINAMENTO TESSUTI-PELLI/MATERIALI"</p> <p>FOR THE CHOICE OF FABRICS AND LEATHERS, SEE BOOK "MATCHING FABRICS-LEATHERS/MATERIALS"</p> <p>Ogni codice identifica il prodotto completo rivestito con un'unica variante di tessuto o pelle. La struttura, la cinghiera elastica e la cuscineria possono anche essere rivestiti con diverse varianti di tessuto o pelle, prezzo su richiesta.</p> <p><i>Each code identifies the complete product coated with a single variant of fabric or leather. The structure, the elastic belts and the cushions can be ordered in different variants of fabric or leather, price upon request.</i></p>	D40184E134	Cat.C misto Lino, Cotone, Viscosa Lisbona/Acciaio verniciato <i>Cat.C mixed Linen, Cotton, Viscose Lisbona/Painted steel</i>	
	D40184E138	Cat.C Lino Barcellona/ Acciaio verniciato <i>Cat.C Linen Barcellona/Painted steel</i>	
	D40184E785	Cat.C Polipropilene Amburgo/ Acciaio verniciato <i>Cat.C Polypropylene Am burgo/Painted steel</i>	
	D40184E803	Cat.D misto Lana vergine, Cotone, Poliammide Malmö/Acciaio verniciato <i>Cat.D mixed virgin Wool, Cotton, Polyamide Malmö/Painted steel</i>	5.800,00
	D40184E812	Cat.E Lana Divina Melange Kvadrat/Acciaio verniciato <i>Cat.E Wool Divina Melange Kvadrat/Painted steel</i>	6.700,00
	D40184E821	Cat.E Cotone Venezia/Acciaio verniciato <i>Cat.E Cotton Venezia/Painted steel</i>	
	D40184E148	Cat.P Pelle Niagara/Acciaio verniciato <i>Cat.P Leather Niagara/Painted steel</i>	6.600,00
	D40184E147	Cat.O Pelle Rio/Acciaio verniciato <i>Cat.O Leather Rio/Painted steel</i>	7.350,00
	D40184E150	Cat.ZME Pelle Amur/Acciaio verniciato <i>Cat.ZME Leather Amur/Painted steel</i>	8.100,00
	D40184E152	Cat.ZA Pelle Purus/Acciaio verniciato <i>Cat.ZA Leather Purus/Painted steel</i>	8.450,00
	D40184E149	Cat.ZC Pelle Churchill/Acciaio verniciato <i>Cat.ZC Leather Churchill/Painted steel</i>	9.800,00

FENIX by Ludovica + Roberto Palomba, 2018

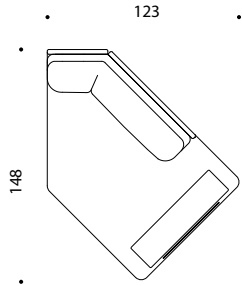
Modello Model	Codice Code	Categoria materiale - Descrizione materiale Material category - Material description	Prezzo Retail con Iva Retail price with Vat
Isola grande destra L. 175 P. 185 H. 75; seduta H. 44; P.L. 60 Kg; V. 2,244 mc Large right ottoman W. 175 D. 185 H. 75; seat H. 44; G.W.. 60 Kg; V. 2,244 cbm	D40235E722	Cat.A Cotone Bonifacio/Acciaio verniciato <i>Cat.A Cotton Bonifacio/Painted steel</i>	6.000,00
	D40235E731	Cat.A Poliestere Marsiglia/Acciaio verniciato <i>Cat.A Polyester Marsiglia/Painted steel</i>	
	D40235E740	Cat.A misto Poliestere, Acrilico, Cotone Petra/Acciaio verniciato <i>Cat.A mixed Polyester, Acrylic, Cotton Petra/Painted steel</i>	
	D40235E749	Cat.A misto Poliestere, Acrilico, Cotone Damasco/Acciaio verniciato <i>Cat.A mixed Polyester, Acrylic, Cotton Damasco/Painted steel</i>	
	D40235E129	Cat.A Ecopelle Colorado/Acciaio verniciato <i>Cat.A Eco-leather Colorado/Painted steel</i>	
	D40235E758	Cat.B misto Poliestere, Acrilico, Cotone Berlino/Acciaio verniciato <i>Cat.B mixed Polyester, Acrylic, Cotton Berlino/Painted steel</i>	6.750,00
	D40235E767	Cat.B Poliestere Jakarta/Acciaio verniciato <i>Cat.B Polyester Jakarta/Painted steel</i>	
	D40235E776	Cat.B Poliestere Ginevra/Acciaio verniciato <i>Cat.B Polyester Ginevra/Painted steel</i>	
	D40235E130	Cat.C Velluto di cotone Loira/Acciaio verniciato <i>Cat.C cotton Velvet Loira/Painted steel</i>	7.100,00
<p>PER LA SCELTA DEI TESSUTI E PELLI CONSULTARE IL LIBRO "ABBINAMENTO TESSUTI-PELLI/MATERIALI"</p> <p>FOR THE CHOICE OF FABRICS AND LEATHERS, SEE BOOK "MATCHING FABRICS-LEATHERS/MATERIALS"</p> <p>Ogni codice identifica il prodotto completo rivestito con un'unica variante di tessuto o pelle. La struttura, la cinghiera elastica e la cuscineria possono anche essere rivestiti con diverse varianti di tessuto o pelle, prezzo su richiesta. <i>Each code identifies the complete product coated with a single variant of fabric or leather. The structure, the elastic belts and the cushions can be ordered in different variants of fabric or leather, price upon request.</i></p>	D40235E134	Cat.C misto Lino, Cotone, Viscosa Lisbona/Acciaio verniciato <i>Cat.C mixed Linen, Cotton, Viscose Lisbona/Painted steel</i>	
	D40235E138	Cat.C Lino Barcellona/ Acciaio verniciato <i>Cat.C Linen Barcellona/Painted steel</i>	
	D40235E785	Cat.C Polipropilene Amburgo/ Acciaio verniciato <i>Cat.C Polypropylene Am burgo/Painted steel</i>	
	D40235E803	Cat.D misto Lana vergine, Cotone, Poliammide Malmö/Acciaio verniciato <i>Cat.D mixed virgin Wool, Cotton, Polyamide Malmö/Painted steel</i>	7.450,00
	D40235E812	Cat.E Lana Divina Melange Kvadrat/Acciaio verniciato <i>Cat.E Wool Divina Melange Kvadrat/Painted steel</i>	8.900,00
	D40235E821	Cat.E Cotone Venezia/Acciaio verniciato <i>Cat.E Cotton Venezia/Painted steel</i>	
	D40235E148	Cat.P Pelle Niagara/Acciaio verniciato <i>Cat.P Leather Niagara/Painted steel</i>	8.700,00
	D40235E147	Cat.O Pelle Rio/Acciaio verniciato <i>Cat.O Leather Rio/Painted steel</i>	9.700,00
	D40235E150	Cat.ZME Pelle Amur/Acciaio verniciato <i>Cat.ZME Leather Amur/Painted steel</i>	10.500,00
	D40235E152	Cat.ZA Pelle Purus/Acciaio verniciato <i>Cat.ZA Leather Purus/Painted steel</i>	11.150,00
	D40235E149	Cat.ZC Pelle Churchill/Acciaio verniciato <i>Cat.ZC Leather Churchill/Painted steel</i>	12.850,00

FENIX by Ludovica + Roberto Palomba, 2018

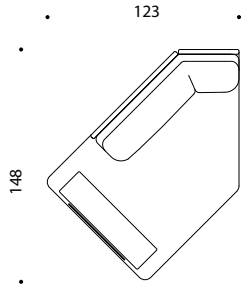
Modello Model	Codice Code	Categoria materiale - Descrizione materiale Material category - Material description	Prezzo Retail con Iva Retail price with Vat
Isola grande sinistra L. 175 P. 185 H. 75; seduta H. 44; P.L. 60 Kg; V. 2,244 mc Large left ottoman W. 175 D. 185 H. 75; seat H. 44; G.W.. 60 Kg; V. 2,244 cbm	D40236E722	Cat.A Cotone Bonifacio/Acciaio verniciato Cat.A Cotton Bonifacio/Painted steel	6.000,00
	D40236E731	Cat.A Poliestere Marsiglia/Acciaio verniciato Cat.A Polyester Marsiglia/Painted steel	
	D40236E740	Cat.A misto Poliestere, Acrilico, Cotone Petra/Acciaio verniciato Cat.A mixed Polyester, Acrylic, Cotton Petra/Painted steel	
	D40236E749	Cat.A misto Poliestere, Acrilico, Cotone Damasco/Acciaio verniciato Cat.A mixed Polyester, Acrylic, Cotton Damasco/Painted steel	
	D40236E129	Cat.A Ecopelle Colorado/Acciaio verniciato Cat.A Eco-leather Colorado/Painted steel	
	D40236E758	Cat.B misto Poliestere, Acrilico, Cotone Berlino/Acciaio verniciato Cat.B mixed Polyester, Acrylic, Cotton Berlino/Painted steel	6.750,00
	D40236E767	Cat.B Poliestere Jakarta/Acciaio verniciato Cat.B Polyester Jakarta/Painted steel	
	D40236E776	Cat.B Poliestere Ginevra/Acciaio verniciato Cat.B Polyester Ginevra/Painted steel	
	D40236E130	Cat.C Velluto di cotone Loira/Acciaio verniciato Cat.C cotton Velvet Loira/Painted steel	7.100,00
	D40236E134	Cat.C misto Lino, Cotone, Viscosa Lisbona/Acciaio verniciato Cat.C mixed Linen, Cotton, Viscose Lisbona/Painted steel	
	D40236E138	Cat.C Lino Barcellona/ Acciaio verniciato Cat.C Linen Barcellona/Painted steel	
	D40236E785	Cat.C Polipropilene Amburgo/ Acciaio verniciato Cat.C Polypropylene Am burgo/Painted steel	
	D40236E803	Cat.D misto Lana vergine, Cotone, Poliammide Malmö/Acciaio verniciato Cat.D mixed virgin Wool, Cotton, Polyamide Malmö/Painted steel	7.450,00
	D40236E812	Cat.E Lana Divina Melange Kvadrat/Acciaio verniciato Cat.E Wool Divina Melange Kvadrat/Painted steel	8.900,00
	D40236E821	Cat.E Cotone Venezia/Acciaio verniciato Cat.E Cotton Venezia/Painted steel	
	D40236E148	Cat.P Pelle Niagara/Acciaio verniciato Cat.P Leather Niagara/Painted steel	8.700,00
	D40236E147	Cat.O Pelle Rio/Acciaio verniciato Cat.O Leather Rio/Painted steel	9.700,00
	D40236E150	Cat.ZME Pelle Amur/Acciaio verniciato Cat.ZME Leather Amur/Painted steel	10.500,00
	D40236E152	Cat.ZA Pelle Purus/Acciaio verniciato Cat.ZA Leather Purus/Painted steel	11.150,00
	D40236E149	Cat.ZC Pelle Churchill/Acciaio verniciato Cat.ZC Leather Churchill/Painted steel	12.850,00

PER LA SCELTA DEI TESSUTI E PELLI CONSULTARE IL LIBRO "ABBINAMENTO TESSUTI-PELLI/MATERIALI"

FOR THE CHOICE OF FABRICS AND LEATHERS, SEE BOOK "MATCHING FABRICS-LEATHERS/MATERIALS"

Ogni codice identifica il prodotto completo rivestito con un'unica variante di tessuto o pelle. La struttura, la cinghiatura elastica e la cuscineria possono anche essere rivestiti con diverse varianti di tessuto o pelle, prezzo su richiesta.

Each code identifies the complete product coated with a single variant of fabric or leather. The structure, the elastic belts and the cushions can be ordered in different variants of fabric or leather, price upon request.

FENIX by Ludovica + Roberto Palomba, 2018

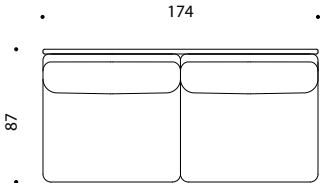
Modello Model	Codice Code	Categoria materiale - Descrizione materiale Material category - Material description	Prezzo Retail con Iva Retail price with Vat
<p>Elemento centrale L. 174 P. 87 H. 75; seduta H. 44; P.L. 60 Kg; V. 1,170 mc</p> <p>Central element W. 174 D. 87 H. 75; seat H. 44; G.W. 60 Kg; V. 1,170 cbm</p> 	D40135M722	Cat.A Cotone Bonifacio/Acciaio verniciato <i>Cat.A Cotton Bonifacio/Painted steel</i>	4.790,00
	D40135M731	Cat.A Poliestere Marsiglia/Acciaio verniciato <i>Cat.A Polyester Marsiglia/Painted steel</i>	
	D40135M740	Cat.A misto Poliestere, Acrilico, Cotone Petra/Acciaio verniciato <i>Cat.A mixed Polyester, Acrylic, Cotton Petra/Painted steel</i>	
	D40135M749	Cat.A misto Poliestere, Acrilico, Cotone Damasco/Acciaio verniciato <i>Cat.A mixed Polyester, Acrylic, Cotton Damasco/Painted steel</i>	
	D40135M129	Cat.A Ecopelle Colorado/Acciaio verniciato <i>Cat.A Eco-leather Colorado/Painted steel</i>	
	D40135M758	Cat.B misto Poliestere, Acrilico, Cotone Berlino/Acciaio verniciato <i>Cat.B mixed Polyester, Acrylic, Cotton Berlino/Painted steel</i>	5.300,00
	D40135M767	Cat.B Poliestere Jakarta/Acciaio verniciato <i>Cat.B Polyester Jakarta/Painted steel</i>	
	D40135M776	Cat.B Poliestere Ginevra/Acciaio verniciato <i>Cat.B Polyester Ginevra/Painted steel</i>	
	D40135M130	Cat.C Velluto di cotone Loira/Acciaio verniciato <i>Cat.C cotton Velvet Loira/Painted steel</i>	5.500,00
	D40135M134	Cat.C misto Lino, Cotone, Viscosa Lisbona/Acciaio verniciato <i>Cat.C mixed Linen, Cotton, Viscose Lisbona/Painted steel</i>	
	D40135M138	Cat.C Lino Barcellona/ Acciaio verniciato <i>Cat.C Linen Barcellona/Painted steel</i>	
	D40135M785	Cat.C Polipropilene Amburgo/ Acciaio verniciato <i>Cat.C Polypropylene Am burgo/Painted steel</i>	
	D40135M803	Cat.D misto Lana vergine, Cotone, Poliammide Malmö/Acciaio verniciato <i>Cat.D mixed virgin Wool, Cotton, Polyamide Malmö/Painted steel</i>	5.950,00
	D40135M812	Cat.E Lana Divina Melange Kvadrat/Acciaio verniciato <i>Cat.E Wool Divina Melange Kvadrat/Painted steel</i>	6.900,00
	D40135M821	Cat.E Cotone Venezia/Acciaio verniciato <i>Cat.E Cotton Venezia/Painted steel</i>	
	D40135M148	Cat.P Pelle Niagara/Acciaio verniciato <i>Cat.P Leather Niagara/Painted steel</i>	6.750,00
D40135M147	Cat.O Pelle Rio/Acciaio verniciato <i>Cat.O Leather Rio/Painted steel</i>	7.590,00	
D40135M150	Cat.ZME Pelle Amur/Acciaio verniciato <i>Cat.ZME Leather Amur/Painted steel</i>	8.050,00	
D40135M152	Cat.ZA Pelle Purus/Acciaio verniciato <i>Cat.ZA Leather Purus/Painted steel</i>	8.700,00	
D40135M149	Cat.ZC Pelle Churchill/Acciaio verniciato <i>Cat.ZC Leather Churchill/Painted steel</i>	10.400,00	

PER LA SCELTA DEI TESSUTI E PELLI CONSULTARE IL LIBRO "ABBINAMENTO TESSUTI-PELLI/MATERIALI"

FOR THE CHOICE OF FABRICS AND LEATHERS, SEE BOOK "MATCHING FABRICS-LEATHERS/MATERIALS"

Ogni codice identifica il prodotto completo rivestito con un'unica variante di tessuto o pelle. La struttura, la cinghiatura elastica e la cuscineria possono anche essere rivestiti con diverse varianti di tessuto o pelle, prezzo su richiesta.

Each code identifies the complete product coated with a single variant of fabric or leather. The structure, the elastic belts and the cushions can be ordered in different variants of fabric or leather, price upon request.

HALL

by Rodolfo Dordoni
1992-2018

Serie di sedute

Struttura in conglomerato ligneo. Imbottitura e cuscini in schiume poliuretaniche e ovatta. Rivestimento fisso in tessuto o pelle. Rivestimento tessuto cliente: quotazione e tempi di consegna da definire all'atto della richiesta. Uso solo interno.

Series of seat

Wooden conglomerate structure. Padding in polyurethane foams and wadding. Fabric or leather fixed cover. COM or COL cover: pricing and delivery time to be agreed on demand. Indoor use only.

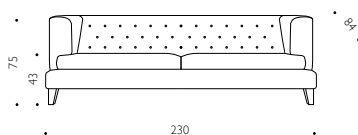

Divano 2 posti/
Two-seater sofa

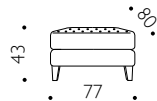

Pouf/
Ottoman

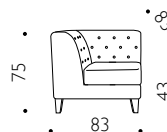

Elemento angolare/
Corner element

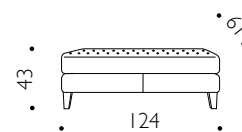

Panca/
Bench

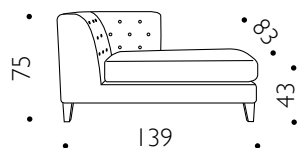

Dormeuse destra/
Right daybed

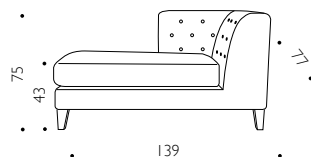

Dormeuse sinistra/
Left daybed

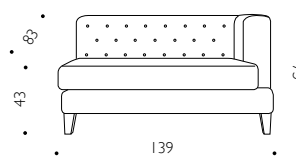

Elemento terminale destro/
Right terminal element

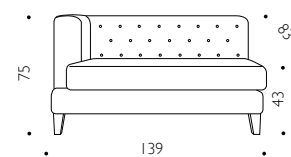

Elemento terminale sinistro/
Left terminal element

Disponibile la versione ignifuga BS 5852 Domestic con maggiorazione del 15% solo per tessuti e pelli contrassegnati con *. Uso solo interno.
Tessuto Cliente consentito, si prega di fare riferimento al nostro servizio clienti.
Available the flame retardant version BS 5852 Domestic with 15% surcharge only for fabrics and leathers marked with *. Indoor use only.
COM and COL allowed, please refer to our Customer Service.



Codice campione
Sample code
ND/NA

Campionario nr.
Sample box n.

HALL by Rodolfo Dordoni, 1992-2018

Modello Model	Codice Code	Categoria materiale - Descrizione materiale Material category - Material description	Prezzo Retail con Iva Retail price with Vat
Divano L. 230 P. 84 H. 75; Seduta H. 43; P.L. 70 Kg; V. 1,918 mc Sofa W. 230 D. 84 H. 75; Seat H. 43; G.W. 70 Kg; V. 1,918 cbm	D80026C700	Cat.A Cotone Bonifacio * Cat.A Cotton Bonifacio *	4.800,00
	D80026C701	Cat.A Poliestere Marsiglia Cat.A Polyester Marsiglia	
	D80026C702	Cat.A misto Poliestere, Acrilico, Cotone Petra Cat.A mixed Polyester, Acrylic, Cotton Petra	
	D80026C703	Cat.A misto Poliestere, Acrilico, Cotone Damasco Cat.A mixed Polyester, Acrylic, Cotton Damasco	
	D80026C704	Cat.B misto Poliestere, Acrilico, Cotone Berlino * Cat.B mixed Polyester, Acrylic, Cotton Berlino *	5.250,00
	D80026C705	Cat.B Poliestere Jakarta Cat.B Polyester Jakarta	
	D80026C706	Cat.B Poliestere Ginevra Cat.B Polyester Ginevra	
	D80026C032	Cat.C Velluto di Cotone Loira * Cat.C Cotton Velvet Loira *	5.500,00
	D80026C036	Cat.C misto Lino, Cotone, Viscosa Lisbona Cat.C mixed Linen, Cotton, Viscose Lisbona	
	D80026C040	Cat.C Lino Barcellona * Cat.C Linen Barcellona *	
D80026C709	Cat.C Polipropilene Amburgo * Cat.C Polypropylene Amburgo *		
D80026C710	Cat.C misto Poliestere, Acrilico, Cotone, Lana, Viscosa Berna * Cat.C mixed Polyester, Acrylic, Cotton, Wool, Viscose Berna *		
D80026C712	Cat.D Lana vergine, Cotone, Poliammide Malmö * Cat.D virgin Wool, Cotton, Polyamide Malmö *	5.750,00	
D80026C713	Cat.E Lana Divina Melange Kvadrat * Cat.E Wool Divina Melange Kvadrat *	6.900,00	
D80026C714	Cat.E Cotone Venezia Cat.E Cotton Venezia		
D80026C050	Cat.P Pelle Niagara * Cat.P Leather Niagara *	6.750,00	
D80026C049	Cat.O Pelle Rio * Cat.O Leather Rio *	7.350,00	
D80026C052	Cat.ZME Pelle Amur * Cat.ZME Leather Amur *	7.980,00	
D80026C054	Cat.ZA Pelle Purus * Cat.ZA Leather Purus *	8.600,00	
D80026C051	Cat.ZC Pelle Churchill * Cat.ZC Leather Churchill *	9.850,00	

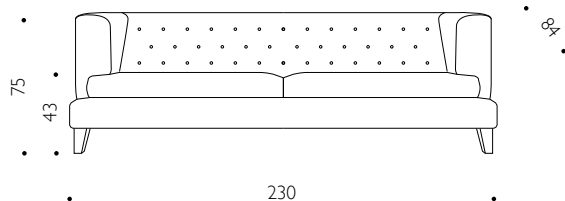

PER LA SCELTA DEI TESSUTI E PELLI CONSULTARE IL LIBRO "ABBINAMENTO TESSUTI-PELLI/MATERIALI"

FOR THE CHOICE OF FABRICS AND LEATHERS, SEE BOOK "MATCHING FABRICS-LEATHERS/MATERIALS"

HALL by Rodolfo Dordoni, 1992-2018

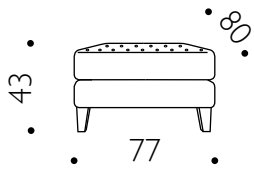
Modello Model	Codice Code	Categoria materiale - Descrizione materiale Material category - Material description	Prezzo Retail con Iva Retail price with Vat
Pouf L. 77 P. 80 H. 43; PL. 25,5 Kg; V. 0,35 mc Ottoman W. 77 D. 80 H. 43; G.W. 25,5 Kg; V. 0,35 cbm	D80170C700	Cat.A Cotone Bonifacio * Cat.A Cotton Bonifacio *	1.790,00
	D80170C701	Cat.A Poliestere Marsiglia Cat.A Polyester Marsiglia	
	D80170C702	Cat.A misto Poliestere, Acrilico, Cotone Petra Cat.A mixed Polyester, Acrylic, Cotton Petra	
	D80170C703	Cat.A misto Poliestere, Acrilico, Cotone Damasco Cat.A mixed Polyester, Acrylic, Cotton Damasco	
	D80170C704	Cat.B misto Poliestere, Acrilico, Cotone Berlino * Cat.B mixed Polyester, Acrylic, Cotton Berlino *	1.900,00
	D80170C705	Cat.B Poliestere Jakarta Cat.B Polyester Jakarta	
	D80170C706	Cat.B Poliestere Ginevra Cat.B Polyester Ginevra	
	D80170C032	Cat.C Velluto di Cotone Loira * Cat.C Cotton Velvet Loira *	2.050,00
	D80170C036	Cat.C misto Lino, Cotone, Viscosa Lisbona Cat.C mixed Linen, Cotton, Viscose Lisbona	
	D80170C040	Cat.C Lino Barcellona * Cat.C Linen Barcellona *	
	D80170C709	Cat.C Polipropilene Amburgo * Cat.C Polypropylene Amburgo *	
	D80170C710	Cat.C misto Poliestere, Acrilico, Cotone, Lana, Viscosa Berna * Cat.C mixed Polyester, Acrylic, Cotton, Wool, Viscose Berna *	
	D80170C712	Cat.D Lana vergine, Cotone, Poliammide Malmö * Cat.D virgin Wool, Cotton, Polyamide Malmö *	2.200,00
PER LA SCELTA DEI TESSUTI E PELLI CONSULTARE IL LIBRO "ABBINAMENTO TESSUTI-PELLI/MATERIALI" FOR THE CHOICE OF FABRICS AND LEATHERS, SEE BOOK "MATCHING FABRICS-LEATHERS/MATERIALS"	D80170C713	Cat.E Lana Divina Melange Kvadrat * Cat.E Wool Divina Melange Kvadrat *	2.390,00
	D80170C714	Cat.E Cotone Venezia Cat.E Cotton Venezia	
	D80170C050	Cat.P Pelle Niagara * Cat.P Leather Niagara *	2.300,00
	D80170C049	Cat.O Pelle Rio * Cat.O Leather Rio *	2.450,00
	D80170C052	Cat.ZME Pelle Amur * Cat.ZME Leather Amur *	2.650,00
	D80170C054	Cat.ZA Pelle Purus * Cat.ZA Leather Purus *	2.800,00
	D80170C051	Cat.ZC Pelle Churchill * Cat.ZC Leather Churchill *	2.900,00

HALL by Rodolfo Dordoni, 1992-2018

Modello Model	Codice Code	Categoria materiale - Descrizione materiale Material category - Material description	Prezzo Retail con Iva Retail price with Vat
Elemento angolare L. 83 P. 83 H. 75; Seduta H. 43; P.L. 34,5 Kg; V. 0,64 mc Corner element W. 83 D. 83 H. 75; Seat H. 43; G.W. 34,5 Kg; V. 0,64 cbm	D80156N700	Cat.A Cotone Bonifacio * Cat.A Cotton Bonifacio *	2.950,00
	D80156N701	Cat.A Poliestere Marsiglia Cat.A Polyester Marsiglia	
	D80156N702	Cat.A misto Poliestere, Acrilico, Cotone Petra Cat.A mixed Polyester, Acrylic, Cotton Petra	
	D80156N703	Cat.A misto Poliestere, Acrilico, Cotone Damasco Cat.A mixed Polyester, Acrylic, Cotton Damasco	
	D80156N704	Cat.B misto Poliestere, Acrilico, Cotone Berlino * Cat.B mixed Polyester, Acrylic, Cotton Berlino *	3.050,00
	D80156N705	Cat.B Poliestere Jakarta Cat.B Polyester Jakarta	
	D80156N706	Cat.B Poliestere Ginevra Cat.B Polyester Ginevra	
	D80156N032	Cat.C Velluto di Cotone Loira * Cat.C Cotton Velvet Loira *	3.200,00
	D80156N036	Cat.C misto Lino, Cotone, Viscosa Lisbona Cat.C mixed Linen, Cotton, Viscose Lisbona	
	D80156N040	Cat.C Lino Barcellona * Cat.C Linen Barcellona *	
D80156N709	Cat.C Polipropilene Amburgo * Cat.C Polypropylene Amburgo *		
D80156N710	Cat.C misto Poliestere, Acrilico, Cotone, Lana, Viscosa Berna * Cat.C mixed Polyester, Acrylic, Cotton, Wool, Viscose Berna *		
D80156N712	Cat.D Lana vergine, Cotone, Poliammide Malmö * Cat.D virgin Wool, Cotton, Polyamide Malmö *	3.350,00	
D80156N713	Cat.E Lana Divina Melange Kvadrat * Cat.E Wool Divina Melange Kvadrat *	3.750,00	
D80156N714	Cat.E Cotone Venezia Cat.E Cotton Venezia		
D80156N050	Cat.P Pelle Niagara * Cat.P Leather Niagara *	3.650,00	
D80156N049	Cat.O Pelle Rio * Cat.O Leather Rio *	3.900,00	
D80156N052	Cat.ZME Pelle Amur * Cat.ZME Leather Amur *	4.050,00	
D80156N054	Cat.ZA Pelle Purus * Cat.ZA Leather Purus *	4.400,00	
D80156N051	Cat.ZC Pelle Churchill * Cat.ZC Leather Churchill *	4.900,00	

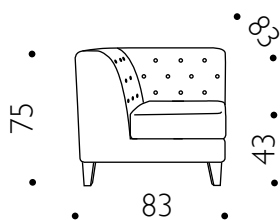

PER LA SCELTA DEI TESSUTI E PELLI CONSULTARE IL LIBRO "ABBINAMENTO TESSUTI-PELLI/MATERIALI"

FOR THE CHOICE OF FABRICS AND LEATHERS, SEE BOOK "MATCHING FABRICS-LEATHERS/MATERIALS"

HALL by Rodolfo Dordoni, 1992-2018

Modello Model	Codice Code	Categoria materiale - Descrizione materiale Material category - Material description	Prezzo Retail con Iva Retail price with Vat
Panca L. 124 P. 61 H. 43; P.L. 28,5 Kg; V. 0,43 mc Bench W. 124 D. 61 H. 43; G.W. 28,5 Kg; V. 0,43 cbm	D80164F700	Cat.A Cotone Bonifacio * Cat.A Cotton Bonifacio *	2.200,00
	D80164F701	Cat.A Poliestere Marsiglia Cat.A Polyester Marsiglia	
	D80164F702	Cat.A misto Poliestere, Acrilico, Cotone Petra Cat.A mixed Polyester, Acrylic, Cotton Petra	
	D80164F703	Cat.A misto Poliestere, Acrilico, Cotone Damasco Cat.A mixed Polyester, Acrylic, Cotton Damasco	
	D80164F704	Cat.B misto Poliestere, Acrilico, Cotone Berlino * Cat.B mixed Polyester, Acrylic, Cotton Berlino *	2.400,00
	D80164F705	Cat.B Poliestere Jakarta Cat.B Polyester Jakarta	
	D80164F706	Cat.B Poliestere Ginevra Cat.B Polyester Ginevra	
	D80164F032	Cat.C Velluto di Cotone Loira * Cat.C Cotton Velvet Loira *	2.500,00
	D80164F036	Cat.C misto Lino, Cotone, Viscosa Lisbona Cat.C mixed Linen, Cotton, Viscose Lisbona	
	D80164F040	Cat.C Lino Barcellona * Cat.C Linen Barcellona *	
D80164F709	Cat.C Polipropilene Amburgo * Cat.C Polypropylene Amburgo *		
D80164F710	Cat.C misto Poliestere, Acrilico, Cotone, Lana, Viscosa Berna * Cat.C mixed Polyester, Acrylic, Cotton, Wool, Viscose Berna *		
D80164F712	Cat.D Lana vergine, Cotone, Poliammide Malmö * Cat.D virgin Wool, Cotton, Polyamide Malmö *	2.700,00	
D80164F713	Cat.E Lana Divina Melange Kvadrat * Cat.E Wool Divina Melange Kvadrat *	2.900,00	
D80164F714	Cat.E Cotone Venezia Cat.E Cotton Venezia		
D80164F050	Cat.P Pelle Niagara * Cat.P Leather Niagara *	2.800,00	
D80164F049	Cat.O Pelle Rio * Cat.O Leather Rio *	3.000,00	
D80164F052	Cat.ZME Pelle Amur * Cat.ZME Leather Amur *	3.150,00	
D80164F054	Cat.ZA Pelle Purus * Cat.ZA Leather Purus *	3.300,00	
D80164F051	Cat.ZC Pelle Churchill * Cat.ZC Leather Churchill *	3.550,00	

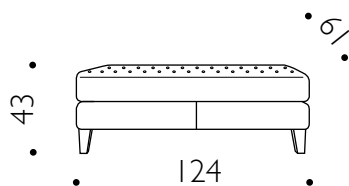

PER LA SCELTA DEI TESSUTI E PELLI CONSULTARE IL LIBRO "ABBINAMENTO TESSUTI-PELLI/MATERIALI"

FOR THE CHOICE OF FABRICS AND LEATHERS, SEE BOOK "MATCHING FABRICS-LEATHERS/MATERIALS"

HALL by Rodolfo Dordoni, 1992-2018

Modello Model	Codice Code	Categoria materiale - Descrizione materiale Material category - Material description	Prezzo Retail con Iva Retail price with Vat
Dormeuse destra L. 139 P. 83 H. 75; Seduta H. 43; P.L. 49 Kg; V. 1,49 mc Right daybed W. 139 D. 83 H. 75; Seat H. 43; G.W. 49 Kg; V. 1,49 cbm	D80053M700	Cat.A Cotone Bonifacio * Cat.A Cotton Bonifacio *	2.900,00
	D80053M701	Cat.A Poliestere Marsiglia Cat.A Polyester Marsiglia	
	D80053M702	Cat.A misto Poliestere, Acrilico, Cotone Petra Cat.A mixed Polyester, Acrylic, Cotton Petra	
	D80053M703	Cat.A misto Poliestere, Acrilico, Cotone Damasco Cat.A mixed Polyester, Acrylic, Cotton Damasco	
	D80053M704	Cat.B misto Poliestere, Acrilico, Cotone Berlino * Cat.B mixed Polyester, Acrylic, Cotton Berlino *	3.200,00
	D80053M705	Cat.B Poliestere Jakarta Cat.B Polyester Jakarta	
	D80053M706	Cat.B Poliestere Ginevra Cat.B Polyester Ginevra	
	D80053M032	Cat.C Velluto di Cotone Loira * Cat.C Cotton Velvet Loira *	3.400,00
	D80053M036	Cat.C misto Lino, Cotone, Viscosa Lisbona Cat.C mixed Linen, Cotton, Viscose Lisbona	
	D80053M040	Cat.C Lino Barcellona * Cat.C Linen Barcellona *	
	D80053M709	Cat.C Polipropilene Amburgo * Cat.C Polypropylene Amburgo *	
	D80053M710	Cat.C misto Poliestere, Acrilico, Cotone, Lana, Viscosa Berna * Cat.C mixed Polyester, Acrylic, Cotton, Wool, Viscose Berna *	
D80053M712	Cat.D Lana vergine, Cotone, Poliammide Malmö * Cat.D virgin Wool, Cotton, Polyamide Malmö *	3.600,00	
D80053M713	Cat.E Lana Divina Melange Kvadrat * Cat.E Wool Divina Melange Kvadrat *	4.400,00	
D80053M714	Cat.E Cotone Venezia Cat.E Cotton Venezia		
D80053M050	Cat.P Pelle Niagara * Cat.P Leather Niagara *	4.300,00	
D80053M049	Cat.O Pelle Rio * Cat.O Leather Rio *	4.650,00	
D80053M052	Cat.ZME Pelle Amur * Cat.ZME Leather Amur *	5.300,00	
D80053M054	Cat.ZA Pelle Purus * Cat.ZA Leather Purus *	5.650,00	
D80053M051	Cat.ZC Pelle Churchill * Cat.ZC Leather Churchill *	6.150,00	

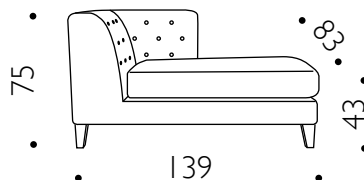

PER LA SCELTA DEI TESSUTI E PELLI CONSULTARE IL LIBRO "ABBINAMENTO TESSUTI-PELLI/MATERIALI"

FOR THE CHOICE OF FABRICS AND LEATHERS, SEE BOOK "MATCHING FABRICS-LEATHERS/MATERIALS"

HALL by Rodolfo Dordoni, 1992-2018

Modello Model	Codice Code	Categoria materiale - Descrizione materiale Material category - Material description	Prezzo Retail con Iva Retail price with Vat
Dormeuse sinistra L. 139 P. 83 H. 75; Seduta H. 43; P.L. 49 Kg; V. 1,49 mc Left daybed W. 139 D. 83 H. 75; Seat H. 43; G.W. 49 Kg; V. 1,49 cbm	D80054M700	Cat.A Cotone Bonifacio * Cat.A Cotton Bonifacio *	2.900,00
	D80054M701	Cat.A Poliestere Marsiglia Cat.A Polyester Marsiglia	
	D80054M702	Cat.A misto Poliestere, Acrilico, Cotone Petra Cat.A mixed Polyester, Acrylic, Cotton Petra	
	D80054M703	Cat.A misto Poliestere, Acrilico, Cotone Damasco Cat.A mixed Polyester, Acrylic, Cotton Damasco	
	D80054M704	Cat.B misto Poliestere, Acrilico, Cotone Berlino * Cat.B mixed Polyester, Acrylic, Cotton Berlino *	3.200,00
	D80054M705	Cat.B Poliestere Jakarta Cat.B Polyester Jakarta	
	D80054M706	Cat.B Poliestere Ginevra Cat.B Polyester Ginevra	
	D80054M032	Cat.C Velluto di Cotone Loira * Cat.C Cotton Velvet Loira *	3.400,00
	D80054M036	Cat.C misto Lino, Cotone, Viscosa Lisbona Cat.C mixed Linen, Cotton, Viscose Lisbona	
	D80054M040	Cat.C Lino Barcellona * Cat.C Linen Barcellona *	
D80054M709	Cat.C Polipropilene Amburgo * Cat.C Polypropylene Amburgo *		
D80054M710	Cat.C misto Poliestere, Acrilico, Cotone, Lana, Viscosa Berna * Cat.C mixed Polyester, Acrylic, Cotton, Wool, Viscose Berna *		
D80054M712	Cat.D Lana vergine, Cotone, Poliammide Malmö * Cat.D virgin Wool, Cotton, Polyamide Malmö *	3.600,00	
D80054M713	Cat.E Lana Divina Melange Kvadrat * Cat.E Wool Divina Melange Kvadrat *	4.400,00	
D80054M714	Cat.E Cotone Venezia Cat.E Cotton Venezia		
D80054M050	Cat.P Pelle Niagara * Cat.P Leather Niagara *	4.300,00	
D80054M049	Cat.O Pelle Rio * Cat.O Leather Rio *	4.650,00	
D80054M052	Cat.ZME Pelle Amur * Cat.ZME Leather Amur *	5.300,00	
D80054M054	Cat.ZA Pelle Purus * Cat.ZA Leather Purus *	5.650,00	
D80054M051	Cat.ZC Pelle Churchill * Cat.ZC Leather Churchill *	6.150,00	

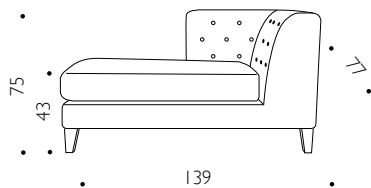

PER LA SCELTA DEI TESSUTI E PELLI CONSULTARE IL LIBRO "ABBINAMENTO TESSUTI-PELLI/MATERIALI"

FOR THE CHOICE OF FABRICS AND LEATHERS, SEE BOOK "MATCHING FABRICS-LEATHERS/MATERIALS"

HALL by Rodolfo Dordoni, 1992-2018

Modello Model	Codice Code	Categoria materiale - Descrizione materiale Material category - Material description	Prezzo Retail con Iva Retail price with Vat
Elemento terminale destro L. 139 P. 83 H. 75; Seduta H. 43; P.L. 49 Kg; V. 1,49 mc Right terminal element W. 139 D. 83 H. 75; Seat H. 43; G.W. 49 Kg; V. 1,49 cbm	D80041E700	Cat.A Cotone Bonifacio * Cat.A Cotton Bonifacio *	3.780,00
	D80041E701	Cat.A Poliestere Marsiglia Cat.A Polyester Marsiglia	
	D80041E702	Cat.A misto Poliestere, Acrilico, Cotone Petra Cat.A mixed Polyester, Acrylic, Cotton Petra	
	D80041E703	Cat.A misto Poliestere, Acrilico, Cotone Damasco Cat.A mixed Polyester, Acrylic, Cotton Damasco	
	D80041E704	Cat.B misto Poliestere, Acrilico, Cotone Berlino * Cat.B mixed Polyester, Acrylic, Cotton Berlino *	4.050,00
	D80041E705	Cat.B Poliestere Jakarta Cat.B Polyester Jakarta	
	D80041E706	Cat.B Poliestere Ginevra Cat.B Polyester Ginevra	
	D80041E032	Cat.C Velluto di Cotone Loira * Cat.C Cotton Velvet Loira *	4.300,00
	D80041E036	Cat.C misto Lino, Cotone, Viscosa Lisbona Cat.C mixed Linen, Cotton, Viscose Lisbona	
	D80041E040	Cat.C Lino Barcellona * Cat.C Linen Barcellona *	
D80041E709	Cat.C Polipropilene Amburgo * Cat.C Polypropylene Amburgo *		
D80041E710	Cat.C misto Poliestere, Acrilico, Cotone, Lana, Viscosa Berna * Cat.C mixed Polyester, Acrylic, Cotton, Wool, Viscose Berna *		
D80041E712	Cat.D Lana vergine, Cotone, Poliammide Malmö * Cat.D virgin Wool, Cotton, Polyamide Malmö *	4.600,00	
D80041E713	Cat.E Lana Divina Melange Kvadrat * Cat.E Wool Divina Melange Kvadrat *	5.500,00	
D80041E714	Cat.E Cotone Venezia Cat.E Cotton Venezia		
D80041E050	Cat.P Pelle Niagara * Cat.P Leather Niagara *	5.400,00	
D80041E049	Cat.O Pelle Rio * Cat.O Leather Rio *	5.650,00	
D80041E052	Cat.ZME Pelle Amur * Cat.ZME Leather Amur *	6.100,00	
D80041E054	Cat.ZA Pelle Purus * Cat.ZA Leather Purus *	6.600,00	
D80041E051	Cat.ZC Pelle Churchill * Cat.ZC Leather Churchill *	7.250,00	

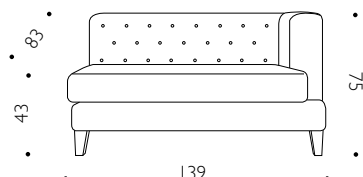

PER LA SCELTA DEI TESSUTI E PELLI CONSULTARE IL LIBRO "ABBINAMENTO TESSUTI-PELLI/MATERIALI"

FOR THE CHOICE OF FABRICS AND LEATHERS, SEE BOOK "MATCHING FABRICS-LEATHERS/MATERIALS"

HALL by Rodolfo Dordoni, 1992-2018

Modello Model	Codice Code	Categoria materiale - Descrizione materiale Material category - Material description	Prezzo Retail con Iva Retail price with Vat
Elemento terminale sinistro L. 139 P. 83 H. 75; Seduta H. 43; P.L. 49 Kg; V. 1,49 mc Left terminal element W. 139 D. 83 H. 75; Seat H. 43; G.W. 49 Kg; V. 1,49 cbm	D80042E700	Cat.A Cotone Bonifacio * Cat.A Cotton Bonifacio *	3.780,00
	D80042E701	Cat.A Poliestere Marsiglia Cat.A Polyester Marsiglia	
	D80042E702	Cat.A misto Poliestere, Acrilico, Cotone Petra Cat.A mixed Polyester, Acrylic, Cotton Petra	
	D80042E703	Cat.A misto Poliestere, Acrilico, Cotone Damasco Cat.A mixed Polyester, Acrylic, Cotton Damasco	
	D80042E704	Cat.B misto Poliestere, Acrilico, Cotone Berlino * Cat.B mixed Polyester, Acrylic, Cotton Berlino *	4.050,00
	D80042E705	Cat.B Poliestere Jakarta Cat.B Polyester Jakarta	
	D80042E706	Cat.B Poliestere Ginevra Cat.B Polyester Ginevra	
	D80042E032	Cat.C Velluto di Cotone Loira * Cat.C Cotton Velvet Loira *	4.300,00
	D80042E036	Cat.C misto Lino, Cotone, Viscosa Lisbona Cat.C mixed Linen, Cotton, Viscose Lisbona	
	D80042E040	Cat.C Lino Barcellona * Cat.C Linen Barcellona *	
D80042E709	Cat.C Polipropilene Amburgo * Cat.C Polypropylene Amburgo *		
D80042E710	Cat.C misto Poliestere, Acrilico, Cotone, Lana, Viscosa Berna * Cat.C mixed Polyester, Acrylic, Cotton, Wool, Viscose Berna *		
D80042E712	Cat.D Lana vergine, Cotone, Poliammide Malmö * Cat.D virgin Wool, Cotton, Polyamide Malmö *	4.600,00	
D80042E713	Cat.E Lana Divina Melange Kvadrat * Cat.E Wool Divina Melange Kvadrat *	5.500,00	
D80042E714	Cat.E Cotone Venezia Cat.E Cotton Venezia		
D80042E050	Cat.P Pelle Niagara * Cat.P Leather Niagara *	5.400,00	
D80042E049	Cat.O Pelle Rio * Cat.O Leather Rio *	5.650,00	
D80042E052	Cat.ZME Pelle Amur * Cat.ZME Leather Amur *	6.100,00	
D80042E054	Cat.ZA Pelle Purus * Cat.ZA Leather Purus *	6.600,00	
D80042E051	Cat.ZC Pelle Churchill * Cat.ZC Leather Churchill *	7.250,00	

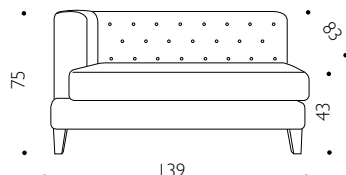

PER LA SCELTA DEI TESSUTI E PELLI CONSULTARE IL LIBRO "ABBINAMENTO TESSUTI-PELLI/MATERIALI"

FOR THE CHOICE OF FABRICS AND LEATHERS, SEE BOOK "MATCHING FABRICS-LEATHERS/MATERIALS"

LIRICO

by Ludovica + Roberto
Palomba
2017

Divani componibili

Struttura in legno dotata di cinghatura elastica e imbottitura in schiume poliuretaniche a quote differenziate. Cuscino di seduta in schiume poliuretaniche a quote differenziate. Cuscino di schienale incluso. Rivestimento sfoderabile in tessuto o fisso in pelle. Piedi in fusione di alluminio, verniciato di colore nero o argento. Uso solo interno. CUSCINI DECORATIVI A PAG.184.

Sectional sofa

Wood structure with elastic belting and padding in polyurethane foams with different densities. Seat cushion in polyurethane foams with different densities. Back cushion included. Removable cover in fabric or fixed in leather. Feet in cast aluminum, painted in black or silver color. Indoor use only. THROW CUSHIONS PAGE 184.

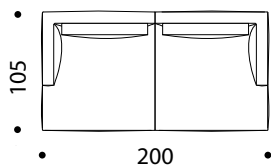

Divano 3 posti/
Three-seater sofa

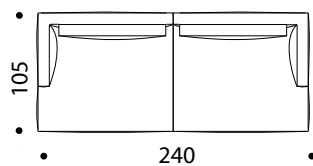

Divano 4 posti/
Four-seater sofa

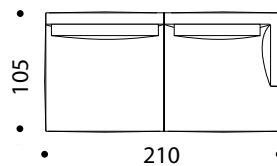

Elemento terminale destro/
Closing right element

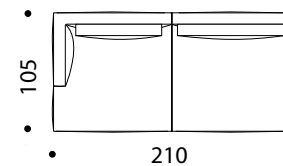

Elemento terminale sinistro/
Closing left element

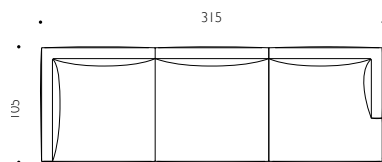

Elemento angolare 3 posti destro/
Three-seater right corner element

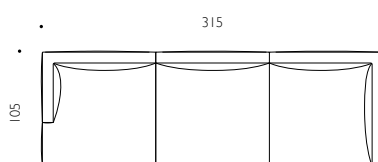

Elemento angolare 3 posti sinistro/
Three-seater left corner element

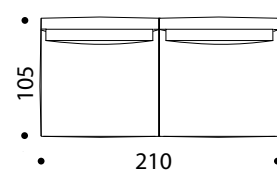

Elemento centrale/
Central element

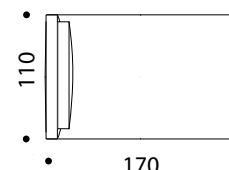

Dormeuse piccola/
Small daybed

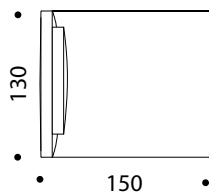

Dormeuse grande/
Large daybed

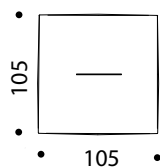

Pouf/
Ottoman

Alluminio verniciato
Nero Ral 9005 opaco
Painted Aluminum
Matt Black Ral 9005

Codice campione
Sample code
VER09103

Campionario nr.
Sample box n.
7

Alluminio verniciato
argento
Painted Aluminum
silver

Codice campione
Sample code
VER04301

Campionario nr.
Sample box n.
7

LIRICO by Ludovica+Roberto Palomba, 2017

Modello Model	Codice Code	Categoria materiale - Descrizione materiale Material category - Material description	Prezzo Retail con Iva Retail price with Vat
Divano 3 posti L. 200 P. 105 H. 80; seduta H. 41; P.L. 65 Kg; V. 1,3 mc Three-seater sofa W. 200 D. 105 H. 80; seat H. 41; G.W. 65 Kg; V. 1,3 cbm	D43526C724	Cat.A Cotone Bonifacio/Alluminio verniciato <i>Cat.A Cotton Bonifacio/Painted Aluminum</i>	5.400,00
	D43526C733	Cat.A Poliestere Marsiglia/Alluminio verniciato <i>Cat.A Polyester Marsiglia/Painted Aluminum</i>	
	D43526C742	Cat.A misto Poliestere, Acrilico, Cotone Petra/Alluminio verniciato <i>Cat.A mixed Polyester, Acrylic, Cotton Petra/Painted Aluminum</i>	
	D43526C751	Cat.A misto Poliestere, Acrilico, Cotone Damasco/Alluminio verniciato <i>Cat.A mixed Polyester, Acrylic, Cotton Damasco/Painted Aluminum</i>	
	D43526C220	Cat.A Ecopelle Colorado/Alluminio verniciato <i>Cat.A Eco-leather Colorado/Painted Aluminum</i>	
	D43526C760	Cat.B misto Poliestere, Acrilico, Cotone Berlino/Alluminio verniciato <i>Cat.B mixed Polyester, Acrylic, Cotton Berlino/Painted Aluminum</i>	5.850,00
	D43526C769	Cat.B Poliestere Jakarta/Alluminio verniciato <i>Cat.B Polyester Jakarta/Painted Aluminum</i>	
	D43526C778	Cat.B Poliestere Ginevra/Alluminio verniciato <i>Cat.B Polyester Ginevra/Painted Aluminum</i>	
	D43526C224	Cat.C Velluto di cotone Loira/Alluminio verniciato <i>Cat.C Cotton Velvet Loira/Painted Aluminum</i>	6.500,00
	D43526C228	Cat.C Misto Lino Lisbona/Alluminio verniciato <i>Cat.C Linen Mix Lisbona/Painted Aluminum</i>	
D43526C232	Cat.C Lino Barcellona/ Alluminio verniciato <i>Cat.C Linen Barcellona/Painted Aluminum</i>		
D43526C787	Cat.C Polipropilene Amburgo/Alluminio verniciato <i>Cat.C Polypropylene Amburgo/Painted Aluminum</i>		
D43526C805	Cat.D Lana vergine, Cotone, Poliammide Malmö/ Alluminio verniciato <i>Cat.D virgin Wool, Cotton, Polyamide Malmö/Painted Aluminum</i>	7.050,00	
D43526C814	Cat.E Lana Divina Melange Kvadrat/Alluminio verniciato <i>Cat.E Wool Divina Melange Kvadrat/Painted Aluminum</i>	7.950,00	
D43526C823	Cat.E Cotone Venezia/Alluminio verniciato <i>Cat.E Cotton Venezia/Painted Aluminum</i>		
D43526C242	Cat.P Pelle Niagara/Alluminio verniciato <i>Cat.P Leather Niagara/Painted Aluminum</i>	7.750,00	
D43526C241	Cat.O Pelle Rio/Alluminio verniciato <i>Cat.O Leather Rio/Painted Aluminum</i>	9.050,00	
D43526C244	Cat.ZME Pelle Amur/Alluminio verniciato <i>Cat.ZME Leather Amur/Painted Aluminum</i>	10.200,00	
D43526C246	Cat.ZA Pelle Purus/Alluminio verniciato <i>Cat.ZA Leather Purus/Painted Aluminum</i>	10.550,00	
D43526C243	Cat.ZC Pelle Churchill/Alluminio verniciato <i>Cat.ZC Leather Churchill/Painted Aluminum</i>	11.550,00	

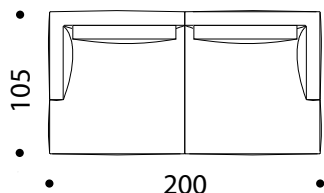

PER LA SCELTA DEI TESSUTI E PELLI CONSULTARE IL LIBRO "ABBINAMENTO TESSUTI-PELLI/MATERIALI"

FOR THE CHOICE OF FABRICS AND LEATHERS, SEE BOOK "MATCHING FABRICS-LEATHERS/MATERIALS"

LIRICO by Ludovica+Roberto Palomba, 2017

Modello Model	Codice Code	Categoria materiale - Descrizione materiale Material category - Material description	Prezzo Retail con Iva Retail price with Vat
Divano 4 posti L. 240 P. 105 H. 80; seduta H. 41; P.L. 70 Kg; V. 1,5 mc Four-seater sofa W. 240 D. 105 H. 80; seat H. 41; G.W. 70 Kg; V. 1,5 cbm	D43529C724	Cat.A Cotone Bonifacio/Alluminio verniciato <i>Cat.A Cotton Bonifacio/Painted Aluminum</i>	5.800,00
	D43529C733	Cat.A Poliestere Marsiglia/Alluminio verniciato <i>Cat.A Polyester Marsiglia/Painted Aluminum</i>	
	D43529C742	Cat.A misto Poliestere, Acrilico, Cotone Petra/Alluminio verniciato <i>Cat.A mixed Polyester, Acrylic, Cotton Petra/Painted Aluminum</i>	
	D43529C751	Cat.A misto Poliestere, Acrilico, Cotone Damasco/Alluminio verniciato <i>Cat.A mixed Polyester, Acrylic, Cotton Damasco/Painted Aluminum</i>	
	D43529C220	Cat.A Ecopelle Colorado/Alluminio verniciato <i>Cat.A Eco-leather Colorado/Painted Aluminum</i>	
	D43529C760	Cat.B misto Poliestere, Acrilico, Cotone Berlino/Alluminio verniciato <i>Cat.B mixed Polyester, Acrylic, Cotton Berlino/Painted Aluminum</i>	6.250,00
	D43529C769	Cat.B Poliestere Jakarta/Alluminio verniciato <i>Cat.B Polyester Jakarta/Painted Aluminum</i>	
	D43529C778	Cat.B Poliestere Ginevra/Alluminio verniciato <i>Cat.B Polyester Ginevra/Painted Aluminum</i>	
	D43529C224	Cat.C Velluto di cotone Loira/Alluminio verniciato <i>Cat.C Cotton Velvet Loira/Painted Aluminum</i>	6.800,00
	D43529C228	Cat.C Misto Lino Lisbona/Alluminio verniciato <i>Cat.C Linen Mix Lisbona/Painted Aluminum</i>	
D43529C232	Cat.C Lino Barcellona/ Alluminio verniciato <i>Cat.C Linen Barcellona/Painted Aluminum</i>		
D43529C787	Cat.C Polipropilene Amburgo/Alluminio verniciato <i>Cat.C Polypropylene Amburgo/Painted Aluminum</i>		
D43529C805	Cat.D Lana vergine, Cotone, Poliammide Malmö/ Alluminio verniciato <i>Cat.D virgin Wool, Cotton, Polyamide Malmö/Painted Aluminum</i>	7.600,00	
D43529C814	Cat.E Lana Divina Melange Kvadrat/Alluminio verniciato <i>Cat.E Wool Divina Melange Kvadrat/Painted Aluminum</i>	8.350,00	
D43529C823	Cat.E Cotone Venezia/Alluminio verniciato <i>Cat.E Cotton Venezia/Painted Aluminum</i>		
D43529C242	Cat.P Pelle Niagara/Alluminio verniciato <i>Cat.P Leather Niagara/Painted Aluminum</i>	8.150,00	
D43529C241	Cat.O Pelle Rio/Alluminio verniciato <i>Cat.O Leather Rio/Painted Aluminum</i>	8.900,00	
D43529C244	Cat.ZME Pelle Amur/Alluminio verniciato <i>Cat.ZME Leather Amur/Painted Aluminum</i>	9.700,00	
D43529C246	Cat.ZA Pelle Purus/Alluminio verniciato <i>Cat.ZA Leather Purus/Painted Aluminum</i>	10.600,00	
D43529C243	Cat.ZC Pelle Churchill/Alluminio verniciato <i>Cat.ZC Leather Churchill/Painted Aluminum</i>	12.100,00	

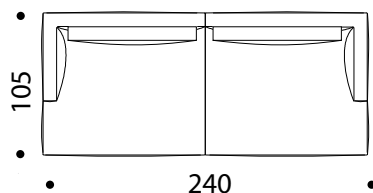

PER LA SCELTA DEI TESSUTI E PELLI CONSULTARE IL LIBRO "ABBINAMENTO TESSUTI-PELLI/MATERIALI"

FOR THE CHOICE OF FABRICS AND LEATHERS, SEE BOOK "MATCHING FABRICS-LEATHERS/MATERIALS"

LIRICO by Ludovica+Roberto Palomba, 2017

Modello Model	Codice Code	Categoria materiale - Descrizione materiale Material category - Material description	Prezzo Retail con Iva Retail price with Vat
Elemento terminale destro L. 210 P. 105 H. 80; seduta H. 65; P.L. 65 Kg; V. 1,3 mc Closing right element W. 210 D. 105 H. 80; seat H. 41; G.W. 65 Kg; V. 1,3 cbm	D43641E724	Cat.A Cotone Bonifacio/Alluminio verniciato <i>Cat.A Cotton Bonifacio/Painted Aluminum</i>	4.850,00
	D43641E733	Cat.A Poliestere Marsiglia/Alluminio verniciato <i>Cat.A Polyester Marsiglia/Painted Aluminum</i>	
	D43641E742	Cat.A misto Poliestere, Acrilico, Cotone Petra/Alluminio verniciato <i>Cat.A mixed Polyester, Acrylic, Cotton Petra/Painted Aluminum</i>	
	D43641E751	Cat.A misto Poliestere, Acrilico, Cotone Damasco/Alluminio verniciato <i>Cat.A mixed Polyester, Acrylic, Cotton Damasco/Painted Aluminum</i>	
	D43641E220	Cat.A Ecopelle Colorado/Alluminio verniciato <i>Cat.A Eco-leather Colorado/Painted Aluminum</i>	
	D43641E760	Cat.B misto Poliestere, Acrilico, Cotone Berlino/Alluminio verniciato <i>Cat.B mixed Polyester, Acrylic, Cotton Berlino/Painted Aluminum</i>	5.200,00
	D43641E769	Cat.B Poliestere Jakarta/Alluminio verniciato <i>Cat.B Polyester Jakarta/Painted Aluminum</i>	
	D43641E778	Cat.B Poliestere Ginevra/Alluminio verniciato <i>Cat.B Polyester Ginevra/Painted Aluminum</i>	
	D43641E224	Cat.C Velluto di cotone Loira/Alluminio verniciato <i>Cat.C Cotton Velvet Loira/Painted Aluminum</i>	5.500,00
	D43641E228	Cat.C Misto Lino Lisbona/Alluminio verniciato <i>Cat.C Linen Mix Lisbona/Painted Aluminum</i>	
D43641E232	Cat.C Lino Barcellona/ Alluminio verniciato <i>Cat.C Linen Barcellona/Painted Aluminum</i>		
D43641E787	Cat.C Polipropilene Amburgo/Alluminio verniciato <i>Cat.C Polypropylene Amburgo/Painted Aluminum</i>		
D43641E805	Cat.D Lana vergine, Cotone, Poliammide Malmö/ Alluminio verniciato <i>Cat.D virgin Wool, Cotton, Polyamide Malmö/Painted Aluminum</i>	5.960,00	
D43641E814	Cat.E Lana Divina Melange Kvadrat/Alluminio verniciato <i>Cat.E Wool Divina Melange Kvadrat/Painted Aluminum</i>	7.100,00	
D43641E823	Cat.E Cotone Venezia/Alluminio verniciato <i>Cat.E Cotton Venezia/Painted Aluminum</i>		
D43641E242	Cat.P Pelle Niagara/Alluminio verniciato <i>Cat.P Leather Niagara/Painted Aluminum</i>	6.950,00	
D43641E241	Cat.O Pelle Rio/Alluminio verniciato <i>Cat.O Leather Rio/Painted Aluminum</i>	7.980,00	
D43641E244	Cat.ZME Pelle Amur/Alluminio verniciato <i>Cat.ZME Leather Amur/Painted Aluminum</i>	8.770,00	
D43641E246	Cat.ZA Pelle Purus/Alluminio verniciato <i>Cat.ZA Leather Purus/Painted Aluminum</i>	9.550,00	
D43641E243	Cat.ZC Pelle Churchill/Alluminio verniciato <i>Cat.ZC Leather Churchill/Painted Aluminum</i>	10.200,00	

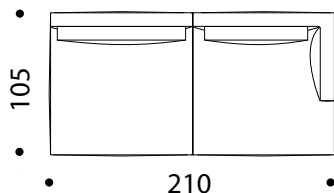

PER LA SCELTA DEI TESSUTI E PELLI CONSULTARE IL LIBRO "ABBINAMENTO TESSUTI-PELLI/MATERIALI"

FOR THE CHOICE OF FABRICS AND LEATHERS, SEE BOOK "MATCHING FABRICS-LEATHERS/MATERIALS"

LIRICO by Ludovica+Roberto Palomba, 2017

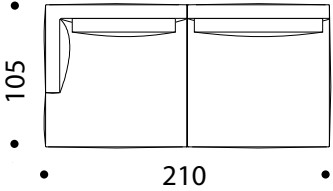
Modello Model	Codice Code	Categoria materiale - Descrizione materiale Material category - Material description	Prezzo Retail con Iva Retail price with Vat
Elemento terminale sinistro L. 210 P. 105 H. 80; seduta H. 65; P.L. 65 Kg; V. 1,3 mc Closing left element W. 210 D. 105 H. 80; seat H. 41; G.W. 65 Kg; V. 1,3 cbm	D43642E724	Cat.A Cotone Bonifacio/Alluminio verniciato <i>Cat.A Cotton Bonifacio/Painted Aluminum</i>	4.850,00
	D43642E733	Cat.A Poliestere Marsiglia/Alluminio verniciato <i>Cat.A Polyester Marsiglia/Painted Aluminum</i>	
	D43642E742	Cat.A misto Poliestere, Acrilico, Cotone Petra/Alluminio verniciato <i>Cat.A mixed Polyester, Acrylic, Cotton Petra/Painted Aluminum</i>	
	D43642E751	Cat.A misto Poliestere, Acrilico, Cotone Damasco/Alluminio verniciato <i>Cat.A mixed Polyester, Acrylic, Cotton Damasco/Painted Aluminum</i>	
	D43642E220	Cat.A Ecopelle Colorado/Alluminio verniciato <i>Cat.A Eco-leather Colorado/Painted Aluminum</i>	
	D43642E760	Cat.B misto Poliestere, Acrilico, Cotone Berlino/Alluminio verniciato <i>Cat.B mixed Polyester, Acrylic, Cotton Berlino/Painted Aluminum</i>	5.200,00
	D43642E769	Cat.B Poliestere Jakarta/Alluminio verniciato <i>Cat.B Polyester Jakarta/Painted Aluminum</i>	
	D43642E778	Cat.B Poliestere Ginevra/Alluminio verniciato <i>Cat.B Polyester Ginevra/Painted Aluminum</i>	
	D43642E224	Cat.C Velluto di cotone Loira/Alluminio verniciato <i>Cat.C Cotton Velvet Loira/Painted Aluminum</i>	5.500,00
<p>PER LA SCELTA DEI TESSUTI E PELLI CONSULTARE IL LIBRO "ABBINAMENTO TESSUTI-PELLI/MATERIALI"</p> <p>FOR THE CHOICE OF FABRICS AND LEATHERS, SEE BOOK "MATCHING FABRICS-LEATHERS/MATERIALS"</p>	D43642E228	Cat.C Misto Lino Lisbona/Alluminio verniciato <i>Cat.C Linen Mix Lisbona/Painted Aluminum</i>	
	D43642E232	Cat.C Lino Barcellona/ Alluminio verniciato <i>Cat.C Linen Barcellona/Painted Aluminum</i>	
	D43642E787	Cat.C Polipropilene Amburgo/Alluminio verniciato <i>Cat.C Polypropylene Amburgo/Painted Aluminum</i>	
	D43642E805	Cat.D Lana vergine, Cotone, Poliammide Malmö/ Alluminio verniciato <i>Cat.D virgin Wool, Cotton, Polyamide Malmö/Painted Aluminum</i>	5.960,00
	D43642E814	Cat.E Lana Divina Melange Kvadrat/Alluminio verniciato <i>Cat.E Wool Divina Melange Kvadrat/Painted Aluminum</i>	7.100,00
	D43642E823	Cat.E Cotone Venezia/Alluminio verniciato <i>Cat.E Cotton Venezia/Painted Aluminum</i>	
	D43642E242	Cat.P Pelle Niagara/Alluminio verniciato <i>Cat.P Leather Niagara/Painted Aluminum</i>	6.950,00
	D43642E241	Cat.O Pelle Rio/Alluminio verniciato <i>Cat.O Leather Rio/Painted Aluminum</i>	7.980,00
	D43642E244	Cat.ZME Pelle Amur/Alluminio verniciato <i>Cat.ZME Leather Amur/Painted Aluminum</i>	8.770,00
	D43642E246	Cat.ZA Pelle Purus/Alluminio verniciato <i>Cat.ZA Leather Purus/Painted Aluminum</i>	9.550,00
	D43642E243	Cat.ZC Pelle Churchill/Alluminio verniciato <i>Cat.ZC Leather Churchill/Painted Aluminum</i>	10.200,00

LIRICO by Ludovica+Roberto Palomba, 2017

Modello Model	Codice Code	Categoria materiale - Descrizione materiale Material category - Material description	Prezzo Retail con Iva Retail price with Vat
Elemento angolare 3 posti destro L. 315 P. 105 H. 80; seduta H. 41; P.L. 99 Kg; V. 1,5 mc Three-seater right corner element W. 315 D. 105 H. 80; seat H. 41; G.W.. 99 Kg; V. 1,5 cbm	D43967D724	Cat.A Cotone Bonifacio/Alluminio verniciato <i>Cat.A Cotton Bonifacio/Painted Aluminum</i>	6.400,00
	D43967D733	Cat.A Poliestere Marsiglia/Alluminio verniciato <i>Cat.A Polyester Marsiglia/Painted Aluminum</i>	
	D43967D742	Cat.A misto Poliestere, Acrilico, Cotone Petra/Alluminio verniciato <i>Cat.A mixed Polyester, Acrylic, Cotton Petra/Painted Aluminum</i>	
	D43967D751	Cat.A misto Poliestere, Acrilico, Cotone Damasco/Alluminio verniciato <i>Cat.A mixed Polyester, Acrylic, Cotton Damasco/Painted Aluminum</i>	
	D43967D220	Cat.A Ecopelle Colorado/Alluminio verniciato <i>Cat.A Eco-leather Colorado/Painted Aluminum</i>	
	D43967D760	Cat.B misto Poliestere, Acrilico, Cotone Berlino/Alluminio verniciato <i>Cat.B mixed Polyester, Acrylic, Cotton Berlino/Painted Aluminum</i>	7.300,00
	D43967D769	Cat.B Poliestere Jakarta/Alluminio verniciato <i>Cat.B Polyester Jakarta/Painted Aluminum</i>	
	D43967D778	Cat.B Poliestere Ginevra/Alluminio verniciato <i>Cat.B Polyester Ginevra/Painted Aluminum</i>	
	D43967D224	Cat.C Velluto di cotone Loira/Alluminio verniciato <i>Cat.C Cotton Velvet Loira/Painted Aluminum</i>	7.600,00
	D43967D228	Cat.C Misto Lino Lisbona/Alluminio verniciato <i>Cat.C Linen Mix Lisbona/Painted Aluminum</i>	
D43967D232	Cat.C Lino Barcellona/ Alluminio verniciato <i>Cat.C Linen Barcellona/Painted Aluminum</i>		
D43967D787	Cat.C Polipropilene Amburgo/Alluminio verniciato <i>Cat.C Polypropylene Amburgo/Painted Aluminum</i>		
D43967D805	Cat.D Lana vergine, Cotone, Poliammide Malmö/ Alluminio verniciato <i>Cat.D virgin Wool, Cotton, Polyamide Malmö/Painted Aluminum</i>	8.500,00	
D43967D814	Cat.E Lana Divina Melange Kvadrat/Alluminio verniciato <i>Cat.E Wool Divina Melange Kvadrat/Painted Aluminum</i>	10.200,00	
D43967D823	Cat.E Cotone Venezia/Alluminio verniciato <i>Cat.E Cotton Venezia/Painted Aluminum</i>		
D43967D242	Cat.P Pelle Niagara/Alluminio verniciato <i>Cat.P Leather Niagara/Painted Aluminum</i>	9.900,00	
D43728A241	Cat.O Pelle Rio/Alluminio verniciato <i>Cat.O Leather Rio/Painted Aluminum</i>	11.100,00	
D43967D244	Cat.ZME Pelle Amur/Alluminio verniciato <i>Cat.ZME Leather Amur/Painted Aluminum</i>	12.900,00	
D43967D246	Cat.ZA Pelle Purus/Alluminio verniciato <i>Cat.ZA Leather Purus/Painted Aluminum</i>	14.400,00	
D43967D243	Cat.ZC Pelle Churchill/Alluminio verniciato <i>Cat.ZC Leather Churchill/Painted Aluminum</i>	16.300,00	

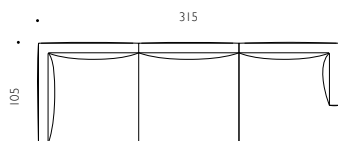

PER LA SCELTA DEI TESSUTI E PELLI CONSULTARE IL LIBRO "ABBINAMENTO TESSUTI-PELLI/MATERIALI"

FOR THE CHOICE OF FABRICS AND LEATHERS, SEE BOOK "MATCHING FABRICS-LEATHERS/MATERIALS"

LIRICO by Ludovica+Roberto Palomba, 2017

Modello Model	Codice Code	Categoria materiale - Descrizione materiale Material category - Material description	Prezzo Retail con Iva Retail price with Vat
Elemento angolare 3 posti sinistro L. 315 P. 105 H. 80; seduta H. 41; P.L. 99 Kg; V. 1,5 mc <i>Three-seater left corner element W. 315 D. 105 H. 80; seat H. 41; G.W.. 99 Kg; V. 1,5 cbm</i>	D43968D724	Cat.A Cotone Bonifacio/Alluminio verniciato <i>Cat.A Cotton Bonifacio/Painted Aluminum</i>	6.400,00
	D43968D733	Cat.A Poliestere Marsiglia/Alluminio verniciato <i>Cat.A Polyester Marsiglia/Painted Aluminum</i>	
	D43968D742	Cat.A misto Poliestere, Acrilico, Cotone Petra/Alluminio verniciato <i>Cat.A mixed Polyester, Acrylic, Cotton Petra/Painted Aluminum</i>	
	D43968D751	Cat.A misto Poliestere, Acrilico, Cotone Damasco/Alluminio verniciato <i>Cat.A mixed Polyester, Acrylic, Cotton Damasco/Painted Aluminum</i>	
	D43968D220	Cat.A Ecopelle Colorado/Alluminio verniciato <i>Cat.A Eco-leather Colorado/Painted Aluminum</i>	
	D43968D760	Cat.B misto Poliestere, Acrilico, Cotone Berlino/Alluminio verniciato <i>Cat.B mixed Polyester, Acrylic, Cotton Berlino/Painted Aluminum</i>	7.300,00
	D43968D769	Cat.B Poliestere Jakarta/Alluminio verniciato <i>Cat.B Polyester Jakarta/Painted Aluminum</i>	
	D43968D778	Cat.B Poliestere Ginevra/Alluminio verniciato <i>Cat.B Polyester Ginevra/Painted Aluminum</i>	
	D43968D224	Cat.C Velluto di cotone Loira/Alluminio verniciato <i>Cat.C Cotton Velvet Loira/Painted Aluminum</i>	7.600,00
	D43968D228	Cat.C Misto Lino Lisbona/Alluminio verniciato <i>Cat.C Linen Mix Lisbona/Painted Aluminum</i>	
D43968D232	Cat.C Lino Barcellona/ Alluminio verniciato <i>Cat.C Linen Barcellona/Painted Aluminum</i>		
D43968D787	Cat.C Polipropilene Amburgo/Alluminio verniciato <i>Cat.C Polypropylene Amburgo/Painted Aluminum</i>		
D43968D805	Cat.D Lana vergine, Cotone, Poliammide Malmö/ Alluminio verniciato <i>Cat.D virgin Wool, Cotton, Polyamide Malmö/Painted Aluminum</i>	8.500,00	
D43968D814	Cat.E Lana Divina Melange Kvadrat/Alluminio verniciato <i>Cat.E Wool Divina Melange Kvadrat/Painted Aluminum</i>	10.200,00	
D43968D823	Cat.E Cotone Venezia/Alluminio verniciato <i>Cat.E Cotton Venezia/Painted Aluminum</i>		
D43968D242	Cat.P Pelle Niagara/Alluminio verniciato <i>Cat.P Leather Niagara/Painted Aluminum</i>	9.900,00	
D43968D241	Cat.O Pelle Rio/Alluminio verniciato <i>Cat.O Leather Rio/Painted Aluminum</i>	11.100,00	
D43968D244	Cat.ZME Pelle Amur/Alluminio verniciato <i>Cat.ZME Leather Amur/Painted Aluminum</i>	12.900,00	
D43968D246	Cat.ZA Pelle Purus/Alluminio verniciato <i>Cat.ZA Leather Purus/Painted Aluminum</i>	14.400,00	
D43968D243	Cat.ZC Pelle Churchill/Alluminio verniciato <i>Cat.ZC Leather Churchill/Painted Aluminum</i>	16.300,00	

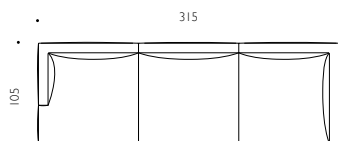

PER LA SCELTA DEI TESSUTI E PELLI CONSULTARE IL LIBRO "ABBINAMENTO TESSUTI-PELLI/MATERIALI"

FOR THE CHOICE OF FABRICS AND LEATHERS, SEE BOOK "MATCHING FABRICS-LEATHERS/MATERIALS"

LIRICO by Ludovica+Roberto Palomba, 2017

Modello Model	Codice Code	Categoria materiale - Descrizione materiale Material category - Material description	Prezzo Retail con Iva Retail price with Vat
Elemento centrale L. 210 P. 105 H. 80; seduta H. 65; P.L. 60 Kg; V. 1,3 mc Central element W. 210 D. 105 H. 80; seat H. 41; G.W. 60 Kg; V. 1,3 cbm	D43545M724	Cat.A Cotone Bonifacio/Alluminio verniciato <i>Cat.A Cotton Bonifacio/Painted Aluminum</i>	4.610,00
	D43545M733	Cat.A Poliestere Marsiglia/Alluminio verniciato <i>Cat.A Polyester Marsiglia/Painted Aluminum</i>	
	D43545M742	Cat.A misto Poliestere, Acrilico, Cotone Petra/Alluminio verniciato <i>Cat.A mixed Polyester, Acrylic, Cotton Petra/Painted Aluminum</i>	
	D43545M751	Cat.A misto Poliestere, Acrilico, Cotone Damasco/Alluminio verniciato <i>Cat.A mixed Polyester, Acrylic, Cotton Damasco/Painted Aluminum</i>	
	D43545M220	Cat.A Ecopelle Colorado/Alluminio verniciato <i>Cat.A Eco-leather Colorado/Painted Aluminum</i>	
	D43545M760	Cat.B misto Poliestere, Acrilico, Cotone Berlino/Alluminio verniciato <i>Cat.B mixed Polyester, Acrylic, Cotton Berlino/Painted Aluminum</i>	4.850,00
	D43545M769	Cat.B Poliestere Jakarta/Alluminio verniciato <i>Cat.B Polyester Jakarta/Painted Aluminum</i>	
	D43545M778	Cat.B Poliestere Ginevra/Alluminio verniciato <i>Cat.B Polyester Ginevra/Painted Aluminum</i>	
	D43545M224	Cat.C Velluto di cotone Loira/Alluminio verniciato <i>Cat.C Cotton Velvet Loira/Painted Aluminum</i>	5.290,00
	D43545M228	Cat.C Misto Lino Lisbona/Alluminio verniciato <i>Cat.C Linen Mix Lisbona/Painted Aluminum</i>	
D43545M232	Cat.C Lino Barcellona/ Alluminio verniciato <i>Cat.C Linen Barcellona/Painted Aluminum</i>		
D43545M787	Cat.C Polipropilene Amburgo/Alluminio verniciato <i>Cat.C Polypropylene Amburgo/Painted Aluminum</i>		
D43545M805	Cat.D Lana vergine, Cotone, Poliammide Malmö/ Alluminio verniciato <i>Cat.D virgin Wool, Cotton, Polyamide Malmö/Painted Aluminum</i>	5.850,00	
D43545M814	Cat.E Lana Divina Melange Kvadrat/Alluminio verniciato <i>Cat.E Wool Divina Melange Kvadrat/Painted Aluminum</i>	6.750,00	
D43545M823	Cat.E Cotone Venezia/Alluminio verniciato <i>Cat.E Cotton Venezia/Painted Aluminum</i>		
D43545M242	Cat.P Pelle Niagara/Alluminio verniciato <i>Cat.P Leather Niagara/Painted Aluminum</i>	6.650,00	
D43545M241	Cat.O Pelle Rio/Alluminio verniciato <i>Cat.O Leather Rio/Painted Aluminum</i>	7.300,00	
D43545M244	Cat.ZME Pelle Amur/Alluminio verniciato <i>Cat.ZME Leather Amur/Painted Aluminum</i>	8.450,00	
D43545M246	Cat.ZA Pelle Purus/Alluminio verniciato <i>Cat.ZA Leather Purus/Painted Aluminum</i>	8.750,00	
D43545M243	Cat.ZC Pelle Churchill/Alluminio verniciato <i>Cat.ZC Leather Churchill/Painted Aluminum</i>	10.200,00	

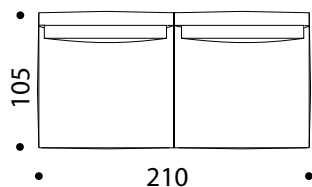

PER LA SCELTA DEI TESSUTI E PELLI CONSULTARE IL LIBRO "ABBINAMENTO TESSUTI-PELLI/MATERIALI"

FOR THE CHOICE OF FABRICS AND LEATHERS, SEE BOOK "MATCHING FABRICS-LEATHERS/MATERIALS"

LIRICO by Ludovica+Roberto Palomba, 2017

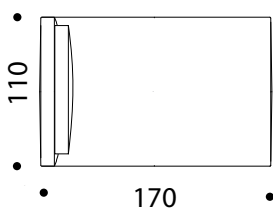
Modello Model	Codice Code	Categoria materiale - Descrizione materiale Material category - Material description	Prezzo Retail con Iva Retail price with Vat
Dormeuse piccola L. 170 P. 110 H. 80; seduta H. 41; P.L. 42 Kg; V. 1,2 mc Small daybed W. 170 D. 110 H. 80; seat H. 41; G.W.. 42 Kg; V. 1,2 cbm	D43709E724	Cat.A Cotone Bonifacio/Alluminio verniciato <i>Cat.A Cotton Bonifacio/Painted Aluminum</i>	3.900,00
	D43709E733	Cat.A Poliestere Marsiglia/Alluminio verniciato <i>Cat.A Polyester Marsiglia/Painted Aluminum</i>	
	D43709E742	Cat.A misto Poliestere, Acrilico, Cotone Petra/Alluminio verniciato <i>Cat.A mixed Polyester, Acrylic, Cotton Petra/Painted Aluminum</i>	
	D43709E751	Cat.A misto Poliestere, Acrilico, Cotone Damasco/Alluminio verniciato <i>Cat.A mixed Polyester, Acrylic, Cotton Damasco/Painted Aluminum</i>	
	D43709E220	Cat.A Ecopelle Colorado/Alluminio verniciato <i>Cat.A Eco-leather Colorado/Painted Aluminum</i>	
	D43709E760	Cat.B misto Poliestere, Acrilico, Cotone Berlino/Alluminio verniciato <i>Cat.B mixed Polyester, Acrylic, Cotton Berlino/Painted Aluminum</i>	4.200,00
	D43709E769	Cat.B Poliestere Jakarta/Alluminio verniciato <i>Cat.B Polyester Jakarta/Painted Aluminum</i>	
	D43709E778	Cat.B Poliestere Ginevra/Alluminio verniciato <i>Cat.B Polyester Ginevra/Painted Aluminum</i>	
<p>PER LA SCELTA DEI TESSUTI E PELLI CONSULTARE IL LIBRO "ABBINAMENTO TESSUTI-PELLI/MATERIALI"</p> <p>FOR THE CHOICE OF FABRICS AND LEATHERS, SEE BOOK "MATCHING FABRICS-LEATHERS/MATERIALS"</p>	D43709E224	Cat.C Velluto di cotone Loira/Alluminio verniciato <i>Cat.C Cotton Velvet Loira/Painted Aluminum</i>	4.500,00
	D43709E228	Cat.C Misto Lino Lisbona/Alluminio verniciato <i>Cat.C Linen Mix Lisbona/Painted Aluminum</i>	
	D43709E232	Cat.C Lino Barcellona/ Alluminio verniciato <i>Cat.C Linen Barcellona/Painted Aluminum</i>	
	D43709E787	Cat.C Polipropilene Amburgo/Alluminio verniciato <i>Cat.C Polypropylene Amburgo/Painted Aluminum</i>	
D43709E805	Cat.D Lana vergine, Cotone, Poliammide Malmö/ Alluminio verniciato <i>Cat.D virgin Wool, Cotton, Polyamide Malmö/Painted Aluminum</i>	4.850,00	
D43709E814	Cat.E Lana Divina Melange Kvadrat/Alluminio verniciato <i>Cat.E Wool Divina Melange Kvadrat/Painted Aluminum</i>	xxxxxx	
D43709E823	Cat.E Cotone Venezia/Alluminio verniciato <i>Cat.E Cotton Venezia/Painted Aluminum</i>		
D43709E242	Cat.P Pelle Niagara/Alluminio verniciato <i>Cat.P Leather Niagara/Painted Aluminum</i>	5.400,00	
D43709E241	Cat.O Pelle Rio/Alluminio verniciato <i>Cat.O Leather Rio/Painted Aluminum</i>	6.200,00	
D43709E244	Cat.ZME Pelle Amur/Alluminio verniciato <i>Cat.ZME Leather Amur/Painted Aluminum</i>	6.700,00	
D43709E246	Cat.ZA Pelle Purus/Alluminio verniciato <i>Cat.ZA Leather Purus/Painted Aluminum</i>	7.250,00	
D43709E243	Cat.ZC Pelle Churchill/Alluminio verniciato <i>Cat.ZC Leather Churchill/Painted Aluminum</i>	7.600,00	

LIRICO by Ludovica+Roberto Palomba, 2017

Modello Model	Codice Code	Categoria materiale - Descrizione materiale Material category - Material description	Prezzo Retail con Iva Retail price with Vat
Dormeuse grande L. 150 P. 130 H. 80; seduta H. 41; P.L. 45 Kg; V. 1,2 mc Large daybed W. 150 D. 130 H. 80; seat H. 41; G.W. 45 Kg; V. 1,2 cbm	D43689E724	Cat.A Cotone Bonifacio/Alluminio verniciato Cat.A Cotton Bonifacio/Painted Aluminum	3.900,00
	D43689E733	Cat.A Poliestere Marsiglia/Alluminio verniciato Cat.A Polyester Marsiglia/Painted Aluminum	
	D43689E742	Cat.A misto Poliestere, Acrilico, Cotone Petra/Alluminio verniciato Cat.A mixed Polyester, Acrylic, Cotton Petra/Painted Aluminum	
	D43689E751	Cat.A misto Poliestere, Acrilico, Cotone Damasco/Alluminio verniciato Cat.A mixed Polyester, Acrylic, Cotton Damasco/Painted Aluminum	
	D43689E220	Cat.A Ecopelle Colorado/Alluminio verniciato Cat.A Eco-leather Colorado/Painted Aluminum	
	D43689E760	Cat.B misto Poliestere, Acrilico, Cotone Berlino/Alluminio verniciato Cat.B mixed Polyester, Acrylic, Cotton Berlino/Painted Aluminum	4.200,00
	D43689E769	Cat.B Poliestere Jakarta/Alluminio verniciato Cat.B Polyester Jakarta/Painted Aluminum	
	D43689E778	Cat.B Poliestere Ginevra/Alluminio verniciato Cat.B Polyester Ginevra/Painted Aluminum	
	D43689E224	Cat.C Velluto di cotone Loira/Alluminio verniciato Cat.C Cotton Velvet Loira/Painted Aluminum	4.500,00
	D43689E228	Cat.C Misto Lino Lisbona/Alluminio verniciato Cat.C Linen Mix Lisbona/Painted Aluminum	
D43689E232	Cat.C Lino Barcellona/ Alluminio verniciato Cat.C Linen Barcellona/Painted Aluminum		
D43689E787	Cat.C Polipropilene Amburgo/Alluminio verniciato Cat.C Polypropylene Amburgo/Painted Aluminum		
D43689E805	Cat.D Lana vergine, Cotone, Poliammide Malmö/ Alluminio verniciato Cat.D virgin Wool, Cotton, Polyamide Malmö/Painted Aluminum	4.850,00	
D43689E814	Cat.E Lana Divina Melange Kvadrat/Alluminio verniciato Cat.E Wool Divina Melange Kvadrat/Painted Aluminum	xxxxxx	
D43689E823	Cat.E Cotone Venezia/Alluminio verniciato Cat.E Cotton Venezia/Painted Aluminum		
D43689E242	Cat.P Pelle Niagara/Alluminio verniciato Cat.P Leather Niagara/Painted Aluminum	5.400,00	
D43689E241	Cat.O Pelle Rio/Alluminio verniciato Cat.O Leather Rio/Painted Aluminum	6.200,00	
D43689E244	Cat.ZME Pelle Amur/Alluminio verniciato Cat.ZME Leather Amur/Painted Aluminum	6.700,00	
D43689E246	Cat.ZA Pelle Purus/Alluminio verniciato Cat.ZA Leather Purus/Painted Aluminum	7.250,00	
D43689E243	Cat.ZC Pelle Churchill/Alluminio verniciato Cat.ZC Leather Churchill/Painted Aluminum	7.600,00	

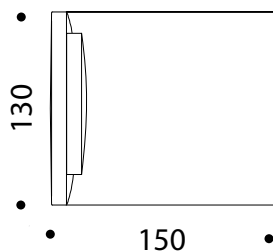

PER LA SCELTA DEI TESSUTI E PELLI CONSULTARE IL LIBRO "ABBINAMENTO TESSUTI-PELLI/MATERIALI"

FOR THE CHOICE OF FABRICS AND LEATHERS, SEE BOOK "MATCHING FABRICS-LEATHERS/MATERIALS"

LIRICO by Ludovica+Roberto Palomba, 2017

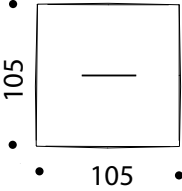
Modello Model	Codice Code	Categoria materiale - Descrizione materiale Material category - Material description	Prezzo Retail con Iva Retail price with Vat
Pouf L. 105 P. 105 H. 41; P.L. 35 Kg; V. 0,60 mc Ottoman W. 105 D. 105 H. 41; G.W. 35 Kg; V. 0,60 cbm	D43781C724	Cat.A Cotone Bonifacio/Alluminio verniciato <i>Cat.A Cotton Bonifacio/Painted Aluminum</i>	2.200,00
	D43781C733	Cat.A Poliestere Marsiglia/Alluminio verniciato <i>Cat.A Polyester Marsiglia/Painted Aluminum</i>	
	D43781C742	Cat.A misto Poliestere, Acrilico, Cotone Petra/Alluminio verniciato <i>Cat.A mixed Polyester, Acrylic, Cotton Petra/Painted Aluminum</i>	
	D43781C751	Cat.A misto Poliestere, Acrilico, Cotone Damasco/Alluminio verniciato <i>Cat.A mixed Polyester, Acrylic, Cotton Damasco/Painted Aluminum</i>	
	D43781C220	Cat.A Ecopelle Colorado/Alluminio verniciato <i>Cat.A Eco-leather Colorado/Painted Aluminum</i>	
	D43781C760	Cat.B misto Poliestere, Acrilico, Cotone Berlino/Alluminio verniciato <i>Cat.B mixed Polyester, Acrylic, Cotton Berlino/Painted Aluminum</i>	2.500,00
	D43781C769	Cat.B Poliestere Jakarta/Alluminio verniciato <i>Cat.B Polyester Jakarta/Painted Aluminum</i>	
	D43781C778	Cat.B Poliestere Ginevra/Alluminio verniciato <i>Cat.B Polyester Ginevra/Painted Aluminum</i>	
	D43781C224	Cat.C Velluto di cotone Loira/Alluminio verniciato <i>Cat.C Cotton Velvet Loira/Painted Aluminum</i>	2.590,00
PER LA SCELTA DEI TESSUTI E PELLI CONSULTARE IL LIBRO "ABBINAMENTO TESSUTI-PELLI/MATERIALI" FOR THE CHOICE OF FABRICS AND LEATHERS, SEE BOOK "MATCHING FABRICS-LEATHERS/MATERIALS"	D43781C228	Cat.C Misto Lino Lisbona/Alluminio verniciato <i>Cat.C Linen Mix Lisbona/Painted Aluminum</i>	
	D43781C232	Cat.C Lino Barcellona/ Alluminio verniciato <i>Cat.C Linen Barcellona/Painted Aluminum</i>	
	D43781C787	Cat.C Polipropilene Amburgo/Alluminio verniciato <i>Cat.C Polypropylene Amburgo/Painted Aluminum</i>	
	D43781C805	Cat.D Lana vergine, Cotone, Poliammide Malmö/ Alluminio verniciato <i>Cat.D virgin Wool, Cotton, Polyamide Malmö/Painted Aluminum</i>	2.750,00
	D43781C814	Cat.E Lana Divina Melange Kvadrat/Alluminio verniciato <i>Cat.E Wool Divina Melange Kvadrat/Painted Aluminum</i>	2.900,00
	D43781C823	Cat.E Cotone Venezia/Alluminio verniciato <i>Cat.E Cotton Venezia/Painted Aluminum</i>	
	D43781C242	Cat.P Pelle Niagara/Alluminio verniciato <i>Cat.P Leather Niagara/Painted Aluminum</i>	2.820,00
	D43781C241	Cat.O Pelle Rio/Alluminio verniciato <i>Cat.O Leather Rio/Painted Aluminum</i>	3.150,00
	D43781C244	Cat.ZME Pelle Amur/Alluminio verniciato <i>Cat.ZME Leather Amur/Painted Aluminum</i>	3.500,00
	D43781C246	Cat.ZA Pelle Purus/Alluminio verniciato <i>Cat.ZA Leather Purus/Painted Aluminum</i>	3.700,00
	D43781C243	Cat.ZC Pelle Churchill/Alluminio verniciato <i>Cat.ZC Leather Churchill/Painted Aluminum</i>	4.200,00

NEIL
by Ludovica+Roberto
Palomba
2018

Divani componibili

Struttura in legno massello di abete e pannello in multistrato, piedino di appoggio a terra in plastica. La struttura nei suoi componenti, schienale, base e bracciolo viene completata da una cinghiatura elastica per ottenere il massimo comfort. Tutte le imbottiture sono costituite da gomme poliuretatiche a densità variabile e resinati con grammatura differenziata. Rivestimento in tessuto sfoderabile o in pelle fisso. Uso solo interno

Sectional sofa

Made of a solid fir wood structure and multilayer panel, plastic foot. The structure in its components, back, base and armrest is completed by an elastic belt for maximum comfort. All upholstery consists of polyurethane rubbers with variable density and resin with different weight. Removable fabric or fixed leather cover. Indoor use only.

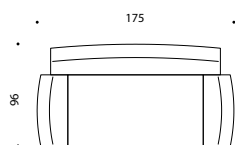

Divano 2 posti/
Two-seater sofa

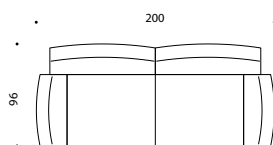

Divano 3 posti/
Three-seater sofa

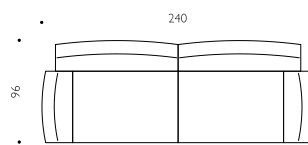

Divano 4 posti/
Four-seater sofa

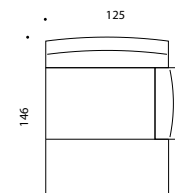

Dormeuse destra/
Right daybed

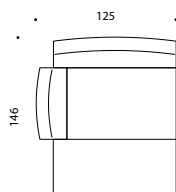

Dormeuse sinistra/
Left daybed

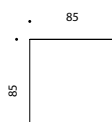

Pouf/
Ottoman

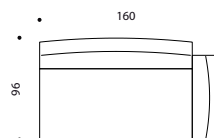

Elemento angolare destro L:160/
Right corner element W. 160

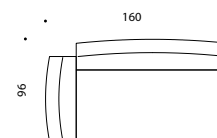

Elemento angolare sinistro L:160/
Left corner element W. 160

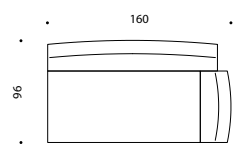

Elemento terminale destro L:160/
Right closing element W. 160

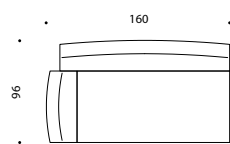

Elemento terminale sinistro L:160/
Left closing element W. 160

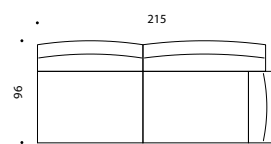

Elemento terminale destro L:215/
Right closing element W. 215

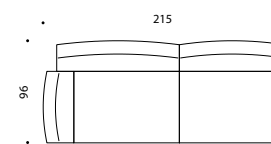

Elemento terminale sinistro L:215/
Left closing element W. 215

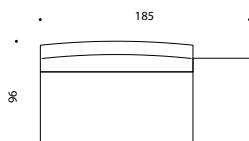

Elemento terminale aperto destro L:185/
Right opened closing element W. 185

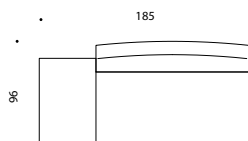

Elemento terminale aperto sinistro L:185/
Left opened closing element W. 185

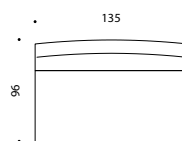

Elemento centrale L:135/
Central element W. 135

NEIL by Ludovica + Roberto Palomba, 2018

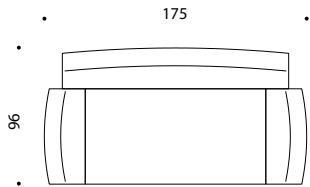
Modello Model	Codice Code	Categoria materiale - Descrizione materiale Material category - Material description	Prezzo Retail con Iva Retail price with Vat
Divano 2 posti L. 175 P. 96 H. 75; seduta H. 42 Two-seater sofa W. 175 D. 96 H. 75; seat H. 42 	D43275C700	Cat.A Cotone Bonifacio <i>Cat.A Cotton Bonifacio</i>	5.450,00
	D43275C701	Cat.A Poliestere Marsiglia <i>Cat.A Polyester Marsiglia</i>	
	D43275C702	Cat.A misto Poliestere, Acrilico, Cotone Petra <i>Cat.A mixed Polyester, Acrylic, Cotton Petra</i>	
	D43275C703	Cat.A misto Poliestere, Acrilico, Cotone Damasco <i>Cat.A mixed Polyester, Acrylic, Cotton Damasco</i>	
	D43275C704	Cat.B misto Poliestere, Acrilico, Cotone Berlino <i>Cat.B mixed Polyester, Acrylic, Cotton Berlino</i>	5.950,00
	D43275C705	Cat.B Poliestere Jakarta <i>Cat.B Polyester Jakarta</i>	
	D43275C706	Cat.B Poliestere Ginevra <i>Cat.B Polyester Ginevra</i>	
	D43275C032	Cat.C Velluto di cotone Loira <i>Cat.C Cotton Velvet Loira</i>	6.200,00
	D43275C036	Cat.C Misto Lino Lisbona <i>Cat.C Linen Mix Lisbona</i>	
	D43275C040	Cat.C Lino Barcellona <i>Cat.C Linen Barcellona</i>	
	D43275C709	Cat.C Polipropilene Amburgo <i>Cat.C Polypropylen Amburgo</i>	
	D43275C710	Cat.C misto Poliestere, Acrilico, Cotone, Lana, Viscosa Berna <i>Cat.C mixed Polyester, Acrylic, Cotton, Wool, Viscose Berna</i>	
	D43275C712	Cat.D Lana vergine, Cotone, Poliammide Malmö <i>Cat.D virgin Wool, Cotton, Polyamide Malmö</i>	6.600,00
	D43275C713	Cat.E Lana Divina Melange Kvadrat <i>Cat.E Wool Divina Melange Kvadrat</i>	6.950,00
	D43275C714	Cat.E Cotone Venezia <i>Cat.E Cotton Venezia</i>	
	D43275C050	Cat.P Pelle Niagara <i>Cat.P Leather Niagara</i>	6.850,00
D43275C049	Cat.O Pelle Rio <i>Cat.O Leather Rio</i>	7.500,00	
D43275C052	Cat.ZME Pelle Amur <i>Cat.ZME Leather Amur</i>	7.900,00	
D43275C054	Cat.ZA Pelle Purus <i>Cat.ZA Leather Purus</i>	8.250,00	
D43275C051	Cat.ZC Pelle Churchill <i>Cat.ZC Leather Churchill</i>	9.400,00	

PER LA SCELTA DEI TESSUTI E PELLI CONSULTARE IL LIBRO "ABBINAMENTO TESSUTI-PELLI/MATERIALI"

FOR THE CHOICE OF FABRICS AND LEATHERS, SEE BOOK "MATCHING FABRICS-LEATHERS/MATERIALS"

NEIL by Ludovica + Roberto Palomba, 2018

Modello Model	Codice Code	Categoria materiale - Descrizione materiale Material category - Material description	Prezzo Retail con Iva Retail price with Vat
Divano 3 posti L. 200 P. 96 H. 75; seduta H. 42 Three-seater sofa W. 200 D. 96 H. 75; seat H. 42	D43276C700	Cat.A Cotone Bonifacio <i>Cat.A Cotton Bonifacio</i>	5.950,00
	D43276C701	Cat.A Poliestere Marsiglia <i>Cat.A Polyester Marsiglia</i>	
	D43276C702	Cat.A misto Poliestere, Acrilico, Cotone Petra <i>Cat.A mixed Polyester, Acrylic, Cotton Petra</i>	
	D43276C703	Cat.A misto Poliestere, Acrilico, Cotone Damasco <i>Cat.A mixed Polyester, Acrylic, Cotton Damasco</i>	
	D43276C704	Cat.B misto Poliestere, Acrilico, Cotone Berlino <i>Cat.B mixed Polyester, Acrylic, Cotton Berlino</i>	6.750,00
	D43276C705	Cat.B Poliestere Jakarta <i>Cat.B Polyester Jakarta</i>	
	D43276C706	Cat.B Poliestere Ginevra <i>Cat.B Polyester Ginevra</i>	
	D43276C032	Cat.C Velluto di cotone Loira <i>Cat.C Cotton Velvet Loira</i>	6.950,00
	D43276C036	Cat.C Misto Lino Lisbona <i>Cat.C Linen Mix Lisbona</i>	
	D43276C040	Cat.C Lino Barcellona <i>Cat.C Linen Barcellona</i>	
D43276C709	Cat.C Polipropilene Amburgo <i>Cat.C Polypropylene Amburgo</i>		
D43276C710	Cat.C misto Poliestere, Acrilico, Cotone, Lana, Viscosa Berna <i>Cat.C mixed Polyester, Acrylic, Cotton, Wool, Viscose Berna</i>		
D43276C712	Cat.D Lana vergine, Cotone, Poliammide Malmö <i>Cat.D virgin Wool, Cotton, Polyamide Malmö</i>	7.350,00	
D43276C713	Cat.E Lana Divina Melange Kvadrat <i>Cat.E Wool Divina Melange Kvadrat</i>	8.600,00	
D43276C714	Cat.E Cotone Venezia <i>Cat.E Cotton Venezia</i>		
D43276C050	Cat.P Pelle Niagara <i>Cat.P Leather Niagara</i>	8.500,00	
D43276C049	Cat.O Pelle Rio <i>Cat.O Leather Rio</i>	9.800,00	
D43276C052	Cat.ZME Pelle Amur <i>Cat.ZME Leather Amur</i>	10.200,00	
D43276C054	Cat.ZA Pelle Purus <i>Cat.ZA Leather Purus</i>	11.200,00	
D43276C051	Cat.ZC Pelle Churchill <i>Cat.ZC Leather Churchill</i>	12.700,00	

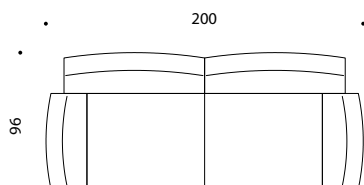

PER LA SCELTA DEI TESSUTI E PELLI CONSULTARE IL LIBRO "ABBINAMENTO TESSUTI-PELLI/MATERIALI"

FOR THE CHOICE OF FABRICS AND LEATHERS, SEE BOOK "MATCHING FABRICS-LEATHERS/MATERIALS"

NEIL by Ludovica + Roberto Palomba, 2018

Modello Model	Codice Code	Categoria materiale - Descrizione materiale Material category - Material description	Prezzo Retail con Iva Retail price with Vat
Divano 4 posti L. 240 P. 96 H. 75; seduta H. 42 Four-seater sofa W. 240 D. 96 H. 75; seat H. 42	D43279C700	Cat.A Cotone Bonifacio Cat.A Cotton Bonifacio	6.770,00
	D43279C701	Cat.A Poliestere Marsiglia Cat.A Polyester Marsiglia	
	D43279C702	Cat.A misto Poliestere, Acrilico, Cotone Petra Cat.A mixed Polyester, Acrylic, Cotton Petra	
	D43279C703	Cat.A misto Poliestere, Acrilico, Cotone Damasco Cat.A mixed Polyester, Acrylic, Cotton Damasco	
	D43279C704	Cat.B misto Poliestere, Acrilico, Cotone Berlino Cat.B mixed Polyester, Acrylic, Cotton Berlino	7.150,00
	D43279C705	Cat.B Poliestere Jakarta Cat.B Polyester Jakarta	
	D43279C706	Cat.B Poliestere Ginevra Cat.B Polyester Ginevra	
	D43279C032	Cat.C Velluto di cotone Loira Cat.C Cotton Velvet Loira	7.600,00
	D43279C036	Cat.C Misto Lino Lisbona Cat.C Linen Mix Lisbona	
	D43279C040	Cat.C Lino Barcellona Cat.C Linen Barcellona	
D43279C709	Cat.C Polipropilene Amburgo Cat.C Polypropylene Amburgo		
D43279C710	Cat.C misto Poliestere, Acrilico, Cotone, Lana, Viscosa Berna Cat.C mixed Polyester, Acrylic, Cotton, Wool, Viscose Berna		
D43279C712	Cat.D Lana vergine, Cotone, Poliammide Malmö Cat.D virgin Wool, Cotton, Polyamide Malmö	8.050,00	
D43279C713	Cat.E Lana Divina Melange Kvadrat Cat.E Wool Divina Melange Kvadrat	9.000,00	
D43279C714	Cat.E Cotone Venezia Cat.E Cotton Venezia		
D43279C050	Cat.P Pelle Niagara Cat.P Leather Niagara	8.900,00	
D43279C049	Cat.O Pelle Rio Cat.O Leather Rio	9.650,00	
D43279C052	Cat.ZME Pelle Amur Cat.ZME Leather Amur	10.700,00	
D43279C054	Cat.ZA Pelle Purus Cat.ZA Leather Purus	11.400,00	
D43279C051	Cat.ZC Pelle Churchill Cat.ZC Leather Churchill	12.700,00	

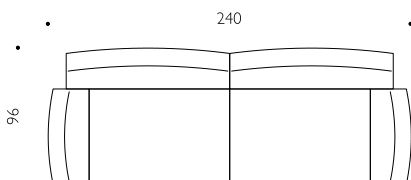

PER LA SCELTA DEI TESSUTI E PELLI CONSULTARE IL LIBRO "ABBINAMENTO TESSUTI-PELLI/MATERIALI"

FOR THE CHOICE OF FABRICS AND LEATHERS, SEE BOOK "MATCHING FABRICS-LEATHERS/MATERIALS"

NEIL by Ludovica + Roberto Palomba, 2018

Modello Model	Codice Code	Categoria materiale - Descrizione materiale Material category - Material description	Prezzo Retail con Iva Retail price with Vat
Pouf L. 85 P. 85 H. 42 Ottoman W. 85 D. 85 H. 42	D43320C700	Cat.A Cotone Bonifacio Cat.A Cotton Bonifacio	1.850,00
	D43320C701	Cat.A Poliestere Marsiglia Cat.A Polyester Marsiglia	
	D43320C702	Cat.A misto Poliestere, Acrilico, Cotone Petra Cat.A mixed Polyester, Acrylic, Cotton Petra	
	D43320C703	Cat.A misto Poliestere, Acrilico, Cotone Damasco Cat.A mixed Polyester, Acrylic, Cotton Damasco	
	D43320C704	Cat.B misto Poliestere, Acrilico, Cotone Berlino Cat.B mixed Polyester, Acrylic, Cotton Berlino	1.990,00
	D43320C705	Cat.B Poliestere Jakarta Cat.B Polyester Jakarta	
	D43320C706	Cat.B Poliestere Ginevra Cat.B Polyester Ginevra	
	D43320C032	Cat.C Velluto di cotone Loira Cat.C Cotton Velvet Loira	2.150,00
	D43320C036	Cat.C Misto Lino Lisbona Cat.C Linen Mix Lisbona	
	D43320C040	Cat.C Lino Barcellona Cat.C Linen Barcellona	
D43320C709	Cat.C Polipropilene Amburgo Cat.C Polypropylene Amburgo		
D43320C710	Cat.C misto Poliestere, Acrilico, Cotone, Lana, Viscosa Berna Cat.C mixed Polyester, Acrylic, Cotton, Wool, Viscose Berna		
D43320C712	Cat.D Lana vergine, Cotone, Poliammide Malmö Cat.D virgin Wool, Cotton, Polyamide Malmö	2.300,00	
D43320C713	Cat.E Lana Divina Melange Kvadrat Cat.E Wool Divina Melange Kvadrat	2.450,00	
D43320C714	Cat.E Cotone Venezia Cat.E Cotton Venezia		
D43320C050	Cat.P Pelle Niagara Cat.P Leather Niagara	2.400,00	
D43320C049	Cat.O Pelle Rio Cat.O Leather Rio	2.500,00	
D43320C052	Cat.ZME Pelle Amur Cat.ZME Leather Amur	2.750,00	
D43320C054	Cat.ZA Pelle Purus Cat.ZA Leather Purus	2.890,00	
D43320C051	Cat.ZC Pelle Churchill Cat.ZC Leather Churchill	3.000,00	

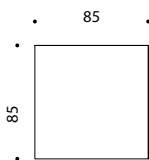

PER LA SCELTA DEI TESSUTI E PELLI CONSULTARE IL LIBRO "ABBINAMENTO TESSUTI-PELLI/MATERIALI"

FOR THE CHOICE OF FABRICS AND LEATHERS, SEE BOOK "MATCHING FABRICS-LEATHERS/MATERIALS"

NEIL by Ludovica + Roberto Palomba, 2018

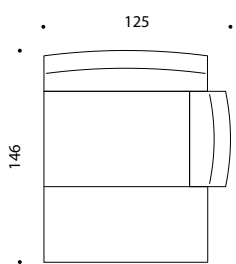
Modello Model	Codice Code	Categoria materiale - Descrizione materiale Material category - Material description	Prezzo Retail con Iva Retail price with Vat
<p>Dormeuse destra L. 146 P. 125 H. 75; seduta H. 42</p> <p><i>Right daybed</i> W. 146 D. 125 H. 75; seat H. 42</p> 	D43303M700	Cat.A Cotone Bonifacio <i>Cat.A Cotton Bonifacio</i>	5.050,00
	D43303M701	Cat.A Poliestere Marsiglia <i>Cat.A Polyester Marsiglia</i>	
	D43303M702	Cat.A misto Poliestere, Acrilico, Cotone Petra <i>Cat.A mixed Polyester, Acrylic, Cotton Petra</i>	
	D43303M703	Cat.A misto Poliestere, Acrilico, Cotone Damasco <i>Cat.A mixed Polyester, Acrylic, Cotton Damasco</i>	
	D43303M704	Cat.B misto Poliestere, Acrilico, Cotone Berlino <i>Cat.B mixed Polyester, Acrylic, Cotton Berlino</i>	5.550,00
	D43303M705	Cat.B Poliestere Jakarta <i>Cat.B Polyester Jakarta</i>	
	D43303M706	Cat.B Poliestere Ginevra <i>Cat.B Polyester Ginevra</i>	
	D43303M032	Cat.C Velluto di cotone Loira <i>Cat.C Cotton Velvet Loira</i>	5.790,00
	D43303M036	Cat.C Misto Lino Lisbona <i>Cat.C Linen Mix Lisbona</i>	
	D43303M040	Cat.C Lino Barcellona <i>Cat.C Linen Barcellona</i>	
	D43303M709	Cat.C Polipropilene Amburgo <i>Cat.C Polypropylene Amburgo</i>	
	D43303M710	Cat.C misto Poliestere, Acrilico, Cotone, Lana, Viscosa Berna <i>Cat.C mixed Polyester, Acrylic, Cotton, Wool, Viscose Berna</i>	
	D43303M712	Cat.D Lana vergine, Cotone, Poliammide Malmö <i>Cat.D virgin Wool, Cotton, Polyamide Malmö</i>	6.200,00
	D43303M713	Cat.E Lana Divina Melange Kvadrat <i>Cat.E Wool Divina Melange Kvadrat</i>	XXXXXX
	D43303M714	Cat.E Cotone Venezia <i>Cat.E Cotton Venezia</i>	
	D43303M050	Cat.P Pelle Niagara <i>Cat.P Leather Niagara</i>	7.100,00
	D43303M049	Cat.O Pelle Rio <i>Cat.O Leather Rio</i>	7.500,00
	D43303M052	Cat.ZME Pelle Amur <i>Cat.ZME Leather Amur</i>	8.250,00
D43303M054	Cat.ZA Pelle Purus <i>Cat.ZA Leather Purus</i>	9.100,00	
D43303M051	Cat.ZC Pelle Churchill <i>Cat.ZC Leather Churchill</i>	9.600,00	

PER LA SCELTA DEI TESSUTI E PELLI CONSULTARE IL LIBRO "ABBINAMENTO TESSUTI-PELLI/MATERIALI"

FOR THE CHOICE OF FABRICS AND LEATHERS, SEE BOOK "MATCHING FABRICS-LEATHERS/MATERIALS"

NEIL by Ludovica + Roberto Palomba, 2018

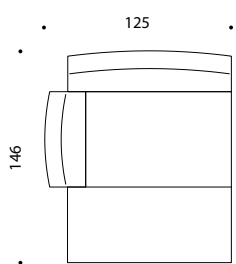
Modello Model	Codice Code	Categoria materiale - Descrizione materiale Material category - Material description	Prezzo Retail con Iva Retail price with Vat
Dormeuse sinistra L. 146 P. 125 H. 75; seduta H. 42 Left daybed W. 146 D. 125 H. 75; seat H. 42 	D43304M700	Cat.A Cotone Bonifacio <i>Cat.A Cotton Bonifacio</i>	5.050,00
	D43304M701	Cat.A Poliestere Marsiglia <i>Cat.A Polyester Marsiglia</i>	
	D43304M702	Cat.A misto Poliestere, Acrilico, Cotone Petra <i>Cat.A mixed Polyester, Acrylic, Cotton Petra</i>	
	D43304M703	Cat.A misto Poliestere, Acrilico, Cotone Damasco <i>Cat.A mixed Polyester, Acrylic, Cotton Damasco</i>	
	D43304M704	Cat.B misto Poliestere, Acrilico, Cotone Berlino <i>Cat.B mixed Polyester, Acrylic, Cotton Berlino</i>	5.550,00
	D43304M705	Cat.B Poliestere Jakarta <i>Cat.B Polyester Jakarta</i>	
	D43304M706	Cat.B Poliestere Ginevra <i>Cat.B Polyester Ginevra</i>	
	D43304M032	Cat.C Velluto di cotone Loira <i>Cat.C Cotton Velvet Loira</i>	5.790,00
	D43304M036	Cat.C Misto Lino Lisbona <i>Cat.C Linen Mix Lisbona</i>	
	D43304M040	Cat.C Lino Barcellona <i>Cat.C Linen Barcellona</i>	
	D43304M709	Cat.C Polipropilene Amburgo <i>Cat.C Polypropylene Amburgo</i>	
	D43304M710	Cat.C misto Poliestere, Acrilico, Cotone, Lana, Viscosa Berna <i>Cat.C mixed Polyester, Acrylic, Cotton, Wool, Viscose Berna</i>	
	D43304M712	Cat.D Lana vergine, Cotone, Poliammide Malmö <i>Cat.D virgin Wool, Cotton, Polyamide Malmö</i>	6.200,00
	D43304M713	Cat.E Lana Divina Melange Kvadrat <i>Cat.E Wool Divina Melange Kvadrat</i>	XXXXXX
	D43304M714	Cat.E Cotone Venezia <i>Cat.E Cotton Venezia</i>	
	D43304M050	Cat.P Pelle Niagara <i>Cat.P Leather Niagara</i>	7.100,00
	D43304M049	Cat.O Pelle Rio <i>Cat.O Leather Rio</i>	7.500,00
	D43304M052	Cat.ZME Pelle Amur <i>Cat.ZME Leather Amur</i>	8.250,00
D43304M054	Cat.ZA Pelle Purus <i>Cat.ZA Leather Purus</i>	9.100,00	
D43304M051	Cat.ZC Pelle Churchill <i>Cat.ZC Leather Churchill</i>	9.600,00	

PER LA SCELTA DEI TESSUTI E PELLI CONSULTARE IL LIBRO "ABBINAMENTO TESSUTI-PELLI/MATERIALI"

FOR THE CHOICE OF FABRICS AND LEATHERS, SEE BOOK "MATCHING FABRICS-LEATHERS/MATERIALS"

NEIL by Ludovica + Roberto Palomba, 2018

Modello Model	Codice Code	Categoria materiale - Descrizione materiale Material category - Material description	Prezzo Retail con Iva Retail price with Vat
Elemento angolare destro L. 160 L. 160 P. 96 H. 75; seduta H. 42 Right corner element W. 160 W. 160 D. 96 H. 75; seat H. 42	D43377D700	Cat.A Cotone Bonifacio <i>Cat.A Cotton Bonifacio</i>	4.800,00
	D43377D701	Cat.A Poliestere Marsiglia <i>Cat.A Polyester Marsiglia</i>	
	D43377D702	Cat.A misto Poliestere, Acrilico, Cotone Petra <i>Cat.A mixed Polyester, Acrylic, Cotton Petra</i>	
	D43377D703	Cat.A misto Poliestere, Acrilico, Cotone Damasco <i>Cat.A mixed Polyester, Acrylic, Cotton Damasco</i>	
	D43377D704	Cat.B misto Poliestere, Acrilico, Cotone Berlino <i>Cat.B mixed Polyester, Acrylic, Cotton Berlino</i>	5.300,00
	D43377D705	Cat.B Poliestere Jakarta <i>Cat.B Polyester Jakarta</i>	
	D43377D706	Cat.B Poliestere Ginevra <i>Cat.B Polyester Ginevra</i>	
	D43377D032	Cat.C Velluto di cotone Loira <i>Cat.C Cotton Velvet Loira</i>	5.600,00
	D43377D036	Cat.C Misto Lino Lisbona <i>Cat.C Linen Mix Lisbona</i>	
	D43377D040	Cat.C Lino Barcellona <i>Cat.C Linen Barcellona</i>	
D43377D709	Cat.C Polipropilene Amburgo <i>Cat.C Polypropylene Amburgo</i>		
D43377D710	Cat.C misto Poliestere, Acrilico, Cotone, Lana, Viscosa Berna <i>Cat.C mixed Polyester, Acrylic, Cotton, Wool, Viscose Berna</i>		
D43377D712	Cat.D Lana vergine, Cotone, Poliammide Malmö <i>Cat.D virgin Wool, Cotton, Polyamide Malmö</i>	5.900,00	
D43377D713	Cat.E Lana Divina Melange Kvadrat <i>Cat.E Wool Divina Melange Kvadrat</i>	6.450,00	
D43377D714	Cat.E Cotone Venezia <i>Cat.E Cotton Venezia</i>		
D43377D050	Cat.P Pelle Niagara <i>Cat.P Leather Niagara</i>	6.350,00	
D43377D049	Cat.O Pelle Rio <i>Cat.O Leather Rio</i>	6.850,00	
D43377D052	Cat.ZME Pelle Amur <i>Cat.ZME Leather Amur</i>	7.350,00	
D43377D054	Cat.ZA Pelle Purus <i>Cat.ZA Leather Purus</i>	7.750,00	
D43377D051	Cat.ZC Pelle Churchill <i>Cat.ZC Leather Churchill</i>	8.750,00	

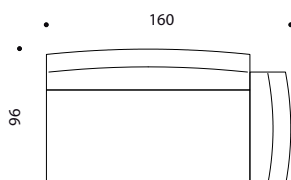

PER LA SCELTA DEI TESSUTI E PELLI CONSULTARE IL LIBRO "ABBINAMENTO TESSUTI-PELLI/MATERIALI"

FOR THE CHOICE OF FABRICS AND LEATHERS, SEE BOOK "MATCHING FABRICS-LEATHERS/MATERIALS"

NEIL by Ludovica + Roberto Palomba, 2018

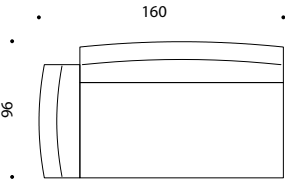
Modello Model	Codice Code	Categoria materiale - Descrizione materiale Material category - Material description	Prezzo Retail con Iva Retail price with Vat
Elemento angolare sinistro L. 160 L. 160 P. 96 H. 75; seduta H. 42 Left corner element W. 160 W. 160 D. 96 H. 75; seat H. 42 	D43378D700	Cat.A Cotone Bonifacio <i>Cat.A Cotton Bonifacio</i>	4.800,00
	D43378D701	Cat.A Poliestere Marsiglia <i>Cat.A Polyester Marsiglia</i>	
	D43378D702	Cat.A misto Poliestere, Acrilico, Cotone Petra <i>Cat.A mixed Polyester, Acrylic, Cotton Petra</i>	
	D43378D703	Cat.A misto Poliestere, Acrilico, Cotone Damasco <i>Cat.A mixed Polyester, Acrylic, Cotton Damasco</i>	
	D43378D704	Cat.B misto Poliestere, Acrilico, Cotone Berlino <i>Cat.B mixed Polyester, Acrylic, Cotton Berlino</i>	5.300,00
	D43378D705	Cat.B Poliestere Jakarta <i>Cat.B Polyester Jakarta</i>	
	D43378D706	Cat.B Poliestere Ginevra <i>Cat.B Polyester Ginevra</i>	
	D43378D032	Cat.C Velluto di cotone Loira <i>Cat.C Cotton Velvet Loira</i>	5.600,00
	D43378D036	Cat.C Misto Lino Lisbona <i>Cat.C Linen Mix Lisbona</i>	
	D43378D040	Cat.C Lino Barcellona <i>Cat.C Linen Barcellona</i>	
	D43378D709	Cat.C Polipropilene Amburgo <i>Cat.C Polypropylene Amburgo</i>	
	D43378D710	Cat.C misto Poliestere, Acrilico, Cotone, Lana, Viscosa Berna <i>Cat.C mixed Polyester, Acrylic, Cotton, Wool, Viscose Berna</i>	
	D43378D712	Cat.D Lana vergine, Cotone, Poliammide Malmö <i>Cat.D virgin Wool, Cotton, Polyamide Malmö</i>	5.900,00
	D43378D713	Cat.E Lana Divina Melange Kvadrat <i>Cat.E Wool Divina Melange Kvadrat</i>	6.450,00
	D43378D714	Cat.E Cotone Venezia <i>Cat.E Cotton Venezia</i>	
	D43378D050	Cat.P Pelle Niagara <i>Cat.P Leather Niagara</i>	6.350,00
	D43378D049	Cat.O Pelle Rio <i>Cat.O Leather Rio</i>	6.850,00
	D43378D052	Cat.ZME Pelle Amur <i>Cat.ZME Leather Amur</i>	7.350,00
D43378D054	Cat.ZA Pelle Purus <i>Cat.ZA Leather Purus</i>	7.750,00	
D43378D051	Cat.ZC Pelle Churchill <i>Cat.ZC Leather Churchill</i>	8.750,00	

PER LA SCELTA DEI TESSUTI E PELLI CONSULTARE IL LIBRO "ABBINAMENTO TESSUTI-PELLI/MATERIALI"

FOR THE CHOICE OF FABRICS AND LEATHERS, SEE BOOK "MATCHING FABRICS-LEATHERS/MATERIALS"

NEIL by Ludovica + Roberto Palomba, 2018

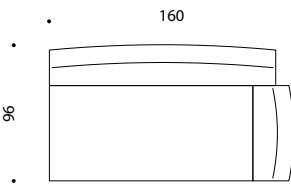
Modello Model	Codice Code	Categoria materiale - Descrizione materiale Material category - Material description	Prezzo Retail con Iva Retail price with Vat
<p>Elemento terminale destro L. 160 L. 160 P. 96 H. 75; seduta H. 42</p> <p><i>Right closing element W. 160 W. 160 D. 96 H. 75; seat H. 42</i></p>  <p>PER LA SCELTA DEI TESSUTI E PELLI CONSULTARE IL LIBRO "ABBINAMENTO TESSUTI-PELLI/MATERIALI"</p> <p><i>FOR THE CHOICE OF FABRICS AND LEATHERS, SEE BOOK "MATCHING FABRICS-LEATHERS/MATERIALS"</i></p>	D43451E700	Cat.A Cotone Bonifacio <i>Cat.A Cotton Bonifacio</i>	5.300,00
	D43451E701	Cat.A Poliestere Marsiglia <i>Cat.A Polyester Marsiglia</i>	
	D43451E702	Cat.A misto Poliestere, Acrilico, Cotone Petra <i>Cat.A mixed Polyester, Acrylic, Cotton Petra</i>	
	D43451E703	Cat.A misto Poliestere, Acrilico, Cotone Damasco <i>Cat.A mixed Polyester, Acrylic, Cotton Damasco</i>	
	D43451E704	Cat.B misto Poliestere, Acrilico, Cotone Berlino <i>Cat.B mixed Polyester, Acrylic, Cotton Berlino</i>	5.800,00
	D43451E705	Cat.B Poliestere Jakarta <i>Cat.B Polyester Jakarta</i>	
	D43451E706	Cat.B Poliestere Ginevra <i>Cat.B Polyester Ginevra</i>	
	D43451E032	Cat.C Velluto di cotone Loira <i>Cat.C Cotton Velvet Loira</i>	6.000,00
	D43451E036	Cat.C Misto Lino Lisbona <i>Cat.C Linen Mix Lisbona</i>	
	D43451E040	Cat.C Lino Barcellona <i>Cat.C Linen Barcellona</i>	
	D43451E709	Cat.C Polipropilene Amburgo <i>Cat.C Polypropylene Amburgo</i>	
	D43451E710	Cat.C misto Poliestere, Acrilico, Cotone, Lana, Viscosa Berna <i>Cat.C mixed Polyester, Acrylic, Cotton, Wool, Viscose Berna</i>	
	D43451E712	Cat.D Lana vergine, Cotone, Poliammide Malmö <i>Cat.D virgin Wool, Cotton, Polyamide Malmö</i>	6.500,00
	D43451E713	Cat.E Lana Divina Melange Kvadrat <i>Cat.E Wool Divina Melange Kvadrat</i>	6.750,00
	D43451E714	Cat.E Cotone Venezia <i>Cat.E Cotton Venezia</i>	
	D43451E050	Cat.P Pelle Niagara <i>Cat.P Leather Niagara</i>	6.650,00
D43451E049	Cat.O Pelle Rio <i>Cat.O Leather Rio</i>	7.300,00	
D43451E052	Cat.ZME Pelle Amur <i>Cat.ZME Leather Amur</i>	7.650,00	
D43451E054	Cat.ZA Pelle Purus <i>Cat.ZA Leather Purus</i>	8.150,00	
D43451E051	Cat.ZC Pelle Churchill <i>Cat.ZC Leather Churchill</i>	9.150,00	

NEIL by Ludovica + Roberto Palomba, 2018

Modello Model	Codice Code	Categoria materiale - Descrizione materiale Material category - Material description	Prezzo Retail con Iva Retail price with Vat
Elemento terminale sinistro L. 160 L. 160 P. 96 H. 75; seduta H. 42 Left closing element W. 160 W. 160 D. 96 H. 75; seat H. 42	D43452E700	Cat.A Cotone Bonifacio <i>Cat.A Cotton Bonifacio</i>	5.300,00
	D43452E701	Cat.A Poliestere Marsiglia <i>Cat.A Polyester Marsiglia</i>	
	D43452E702	Cat.A misto Poliestere, Acrilico, Cotone Petra <i>Cat.A mixed Polyester, Acrylic, Cotton Petra</i>	
	D43452E703	Cat.A misto Poliestere, Acrilico, Cotone Damasco <i>Cat.A mixed Polyester, Acrylic, Cotton Damasco</i>	
	D43452E704	Cat.B misto Poliestere, Acrilico, Cotone Berlino <i>Cat.B mixed Polyester, Acrylic, Cotton Berlino</i>	5.800,00
	D43452E705	Cat.B Poliestere Jakarta <i>Cat.B Polyester Jakarta</i>	
	D43452E706	Cat.B Poliestere Ginevra <i>Cat.B Polyester Ginevra</i>	
	D43452E032	Cat.C Velluto di cotone Loira <i>Cat.C Cotton Velvet Loira</i>	6.000,00
	D43452E036	Cat.C Misto Lino Lisbona <i>Cat.C Linen Mix Lisbona</i>	
	D43452E040	Cat.C Lino Barcellona <i>Cat.C Linen Barcellona</i>	
D43452E709	Cat.C Polipropilene Amburgo <i>Cat.C Polypropylene Amburgo</i>		
D43452E710	Cat.C misto Poliestere, Acrilico, Cotone, Lana, Viscosa Berna <i>Cat.C mixed Polyester, Acrylic, Cotton, Wool, Viscose Berna</i>		
D43452E712	Cat.D Lana vergine, Cotone, Poliammide Malmö <i>Cat.D virgin Wool, Cotton, Polyamide Malmö</i>	6.500,00	
D43452E713	Cat.E Lana Divina Melange Kvadrat <i>Cat.E Wool Divina Melange Kvadrat</i>	6.750,00	
D43452E714	Cat.E Cotone Venezia <i>Cat.E Cotton Venezia</i>		
D43452E050	Cat.P Pelle Niagara <i>Cat.P Leather Niagara</i>	6.650,00	
D43452E049	Cat.O Pelle Rio <i>Cat.O Leather Rio</i>	7.300,00	
D43452E052	Cat.ZME Pelle Amur <i>Cat.ZME Leather Amur</i>	7.650,00	
D43452E054	Cat.ZA Pelle Purus <i>Cat.ZA Leather Purus</i>	8.150,00	
D43452E051	Cat.ZC Pelle Churchill <i>Cat.ZC Leather Churchill</i>	9.150,00	

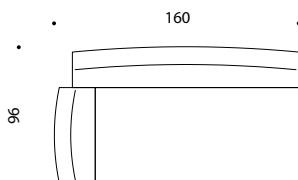

PER LA SCELTA DEI TESSUTI E PELLI CONSULTARE IL LIBRO "ABBINAMENTO TESSUTI-PELLI/MATERIALI"

FOR THE CHOICE OF FABRICS AND LEATHERS, SEE BOOK "MATCHING FABRICS-LEATHERS/MATERIALS"

NEIL by Ludovica + Roberto Palomba, 2018

Modello Model	Codice Code	Categoria materiale - Descrizione materiale Material category - Material description	Prezzo Retail con Iva Retail price with Vat
Elemento terminale destro L. 215 L. 215 P. 96 H. 75; seduta H. 42 Right closing element W. 215 W. 215 D. 96 H. 75; seat H. 42	D43471E700	Cat.A Cotone Bonifacio <i>Cat.A Cotton Bonifacio</i>	6.350,00
	D43471E701	Cat.A Poliestere Marsiglia <i>Cat.A Polyester Marsiglia</i>	
	D43471E702	Cat.A misto Poliestere, Acrilico, Cotone Petra <i>Cat.A mixed Polyester, Acrylic, Cotton Petra</i>	
	D43471E703	Cat.A misto Poliestere, Acrilico, Cotone Damasco <i>Cat.A mixed Polyester, Acrylic, Cotton Damasco</i>	
	D43471E704	Cat.B misto Poliestere, Acrilico, Cotone Berlino <i>Cat.B mixed Polyester, Acrylic, Cotton Berlino</i>	7.050,00
	D43471E705	Cat.B Poliestere Jakarta <i>Cat.B Polyester Jakarta</i>	
	D43471E706	Cat.B Poliestere Ginevra <i>Cat.B Polyester Ginevra</i>	
	D43471E032	Cat.C Velluto di cotone Loira <i>Cat.C Cotton Velvet Loira</i>	7.290,00
	D43471E036	Cat.C Misto Lino Lisbona <i>Cat.C Linen Mix Lisbona</i>	
	D43471E040	Cat.C Lino Barcellona <i>Cat.C Linen Barcellona</i>	
	D43471E709	Cat.C Polipropilene Amburgo <i>Cat.C Polypropylene Amburgo</i>	
	D43471E710	Cat.C misto Poliestere, Acrilico, Cotone, Lana, Viscosa Berna <i>Cat.C mixed Polyester, Acrylic, Cotton, Wool, Viscose Berna</i>	
D43471E712	Cat.D Lana vergine, Cotone, Poliammide Malmö <i>Cat.D virgin Wool, Cotton, Polyamide Malmö</i>	7.750,00	
D43471E713	Cat.E Lana Divina Melange Kvadrat <i>Cat.E Wool Divina Melange Kvadrat</i>	8.950,00	
D43471E714	Cat.E Cotone Venezia <i>Cat.E Cotton Venezia</i>		
D43471E050	Cat.P Pelle Niagara <i>Cat.P Leather Niagara</i>	8.850,00	
D43471E049	Cat.O Pelle Rio <i>Cat.O Leather Rio</i>	9.750,00	
D43471E052	Cat.ZME Pelle Amur <i>Cat.ZME Leather Amur</i>	10.600,00	
D43471E054	Cat.ZA Pelle Purus <i>Cat.ZA Leather Purus</i>	11.000,00	
D43471E051	Cat.ZC Pelle Churchill <i>Cat.ZC Leather Churchill</i>	12.700,00	

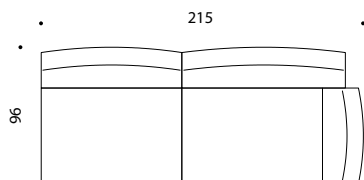

PER LA SCELTA DEI TESSUTI E PELLI CONSULTARE IL LIBRO "ABBINAMENTO TESSUTI-PELLI/MATERIALI"

FOR THE CHOICE OF FABRICS AND LEATHERS, SEE BOOK "MATCHING FABRICS-LEATHERS/MATERIALS"

NEIL by Ludovica + Roberto Palomba, 2018

Modello Model	Codice Code	Categoria materiale - Descrizione materiale Material category - Material description	Prezzo Retail con Iva Retail price with Vat
Elemento terminale sinistro L. 215 L. 215 P. 96 H. 75; seduta H. 42 Left closing element W. 215 W. 215 D. 96 H. 75; seat H. 42	D43472E700	Cat.A Cotone Bonifacio <i>Cat.A Cotton Bonifacio</i>	6.350,00
	D43472E701	Cat.A Poliestere Marsiglia <i>Cat.A Polyester Marsiglia</i>	
	D43472E702	Cat.A misto Poliestere, Acrilico, Cotone Petra <i>Cat.A mixed Polyester, Acrylic, Cotton Petra</i>	
	D43472E703	Cat.A misto Poliestere, Acrilico, Cotone Damasco <i>Cat.A mixed Polyester, Acrylic, Cotton Damasco</i>	
	D43472E704	Cat.B misto Poliestere, Acrilico, Cotone Berlino <i>Cat.B mixed Polyester, Acrylic, Cotton Berlino</i>	7.050,00
	D43472E705	Cat.B Poliestere Jakarta <i>Cat.B Polyester Jakarta</i>	
	D43472E706	Cat.B Poliestere Ginevra <i>Cat.B Polyester Ginevra</i>	
	D43472E032	Cat.C Velluto di cotone Loira <i>Cat.C Cotton Velvet Loira</i>	7.290,00
	D43472E036	Cat.C Misto Lino Lisbona <i>Cat.C Linen Mix Lisbona</i>	
	D43472E040	Cat.C Lino Barcellona <i>Cat.C Linen Barcellona</i>	
D43472E709	Cat.C Polipropilene Amburgo <i>Cat.C Polypropylene Amburgo</i>		
D43472E710	Cat.C misto Poliestere, Acrilico, Cotone, Lana, Viscosa Berna <i>Cat.C mixed Polyester, Acrylic, Cotton, Wool, Viscose Berna</i>		
D43472E712	Cat.D Lana vergine, Cotone, Poliammide Malmö <i>Cat.D virgin Wool, Cotton, Polyamide Malmö</i>	7.750,00	
D43472E713	Cat.E Lana Divina Melange Kvadrat <i>Cat.E Wool Divina Melange Kvadrat</i>	8.950,00	
D43472E714	Cat.E Cotone Venezia <i>Cat.E Cotton Venezia</i>		
D43472E050	Cat.P Pelle Niagara <i>Cat.P Leather Niagara</i>	8.850,00	
D43472E049	Cat.O Pelle Rio <i>Cat.O Leather Rio</i>	9.750,00	
D43472E052	Cat.ZME Pelle Amur <i>Cat.ZME Leather Amur</i>	10.600,00	
D43472E054	Cat.ZA Pelle Purus <i>Cat.ZA Leather Purus</i>	11.000,00	
D43472E051	Cat.ZC Pelle Churchill <i>Cat.ZC Leather Churchill</i>	12.700,00	

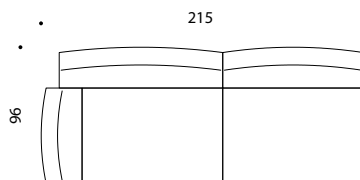

PER LA SCELTA DEI TESSUTI E PELLI CONSULTARE IL LIBRO "ABBINAMENTO TESSUTI-PELLI/MATERIALI"

FOR THE CHOICE OF FABRICS AND LEATHERS, SEE BOOK "MATCHING FABRICS-LEATHERS/MATERIALS"

NEIL by Ludovica + Roberto Palomba, 2018

Modello Model	Codice Code	Categoria materiale - Descrizione materiale Material category - Material description	Prezzo Retail con Iva Retail price with Vat
Elemento terminale aperto destro L. 185 L. 185 P. 96 H. 75; seduta H. 42 Right opened closing element W. 185 W. 185 D. 96 H. 75; seat H. 42	D43871E700	Cat.A Cotone Bonifacio <i>Cat.A Cotton Bonifacio</i>	5.100,00
	D43871E701	Cat.A Poliestere Marsiglia <i>Cat.A Polyester Marsiglia</i>	
	D43871E702	Cat.A misto Poliestere, Acrilico, Cotone Petra <i>Cat.A mixed Polyester, Acrylic, Cotton Petra</i>	
	D43871E703	Cat.A misto Poliestere, Acrilico, Cotone Damasco <i>Cat.A mixed Polyester, Acrylic, Cotton Damasco</i>	
	D43871E704	Cat.B misto Poliestere, Acrilico, Cotone Berlino <i>Cat.B mixed Polyester, Acrylic, Cotton Berlino</i>	5.500,00
	D43871E705	Cat.B Poliestere Jakarta <i>Cat.B Polyester Jakarta</i>	
	D43871E706	Cat.B Poliestere Ginevra <i>Cat.B Polyester Ginevra</i>	
	D43871E032	Cat.C Velluto di cotone Loira <i>Cat.C Cotton Velvet Loira</i>	5.750,00
	D43871E036	Cat.C Misto Lino Lisbona <i>Cat.C Linen Mix Lisbona</i>	
	D43871E040	Cat.C Lino Barcellona <i>Cat.C Linen Barcellona</i>	
D43871E709	Cat.C Polipropilene Amburgo <i>Cat.C Polypropylene Amburgo</i>		
D43871E710	Cat.C misto Poliestere, Acrilico, Cotone, Lana, Viscosa Berna <i>Cat.C mixed Polyester, Acrylic, Cotton, Wool, Viscose Berna</i>		
D43871E712	Cat.D Lana vergine, Cotone, Poliammide Malmö <i>Cat.D virgin Wool, Cotton, Polyamide Malmö</i>	6.200,00	
D43871E713	Cat.E Lana Divina Melange Kvadrat <i>Cat.E Wool Divina Melange Kvadrat</i>	6.650,00	
D43871E714	Cat.E Cotone Venezia <i>Cat.E Cotton Venezia</i>		
D43871E050	Cat.P Pelle Niagara <i>Cat.P Leather Niagara</i>	6.550,00	
D43871E049	Cat.O Pelle Rio <i>Cat.O Leather Rio</i>	7.200,00	
D43871E052	Cat.ZME Pelle Amur <i>Cat.ZME Leather Amur</i>	7.550,00	
D43871E054	Cat.ZA Pelle Purus <i>Cat.ZA Leather Purus</i>	7.800,00	
D43871E051	Cat.ZC Pelle Churchill <i>Cat.ZC Leather Churchill</i>	8.800,00	

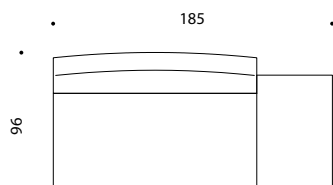

PER LA SCELTA DEI TESSUTI E PELLI CONSULTARE IL LIBRO "ABBINAMENTO TESSUTI-PELLI/MATERIALI"

FOR THE CHOICE OF FABRICS AND LEATHERS, SEE BOOK "MATCHING FABRICS-LEATHERS/MATERIALS"

NEIL by Ludovica + Roberto Palomba, 2018

Modello Model	Codice Code	Categoria materiale - Descrizione materiale Material category - Material description	Prezzo Retail con Iva Retail price with Vat
Elemento terminale aperto sinistro L. 185 L. 185 P. 96 H. 75; seduta H. 42 Left opened closing element W. 185 W. 185 D. 96 H. 75; seat H. 42	D43872E700	Cat.A Cotone Bonifacio <i>Cat.A Cotton Bonifacio</i>	5.100,00
	D43872E701	Cat.A Poliestere Marsiglia <i>Cat.A Polyester Marsiglia</i>	
	D43872E702	Cat.A misto Poliestere, Acrilico, Cotone Petra <i>Cat.A mixed Polyester, Acrylic, Cotton Petra</i>	
	D43872E703	Cat.A misto Poliestere, Acrilico, Cotone Damasco <i>Cat.A mixed Polyester, Acrylic, Cotton Damasco</i>	
	D43872E704	Cat.B misto Poliestere, Acrilico, Cotone Berlino <i>Cat.B mixed Polyester, Acrylic, Cotton Berlino</i>	5.500,00
	D43872E705	Cat.B Poliestere Jakarta <i>Cat.B Polyester Jakarta</i>	
	D43872E706	Cat.B Poliestere Ginevra <i>Cat.B Polyester Ginevra</i>	
	D43872E032	Cat.C Velluto di cotone Loira <i>Cat.C Cotton Velvet Loira</i>	5.750,00
	D43872E036	Cat.C Misto Lino Lisbona <i>Cat.C Linen Mix Lisbona</i>	
	D43872E040	Cat.C Lino Barcellona <i>Cat.C Linen Barcellona</i>	
D43872E709	Cat.C Polipropilene Amburgo <i>Cat.C Polypropylene Amburgo</i>		
D43872E710	Cat.C misto Poliestere, Acrilico, Cotone, Lana, Viscosa Berna <i>Cat.C mixed Polyester, Acrylic, Cotton, Wool, Viscose Berna</i>		
D43872E712	Cat.D Lana vergine, Cotone, Poliammide Malmö <i>Cat.D virgin Wool, Cotton, Polyamide Malmö</i>	6.200,00	
D43872E713	Cat.E Lana Divina Melange Kvadrat <i>Cat.E Wool Divina Melange Kvadrat</i>	6.650,00	
D43872E714	Cat.E Cotone Venezia <i>Cat.E Cotton Venezia</i>		
D43872E050	Cat.P Pelle Niagara <i>Cat.P Leather Niagara</i>	6.550,00	
D43872E049	Cat.O Pelle Rio <i>Cat.O Leather Rio</i>	7.200,00	
D43872E052	Cat.ZME Pelle Amur <i>Cat.ZME Leather Amur</i>	7.550,00	
D43872E054	Cat.ZA Pelle Purus <i>Cat.ZA Leather Purus</i>	7.800,00	
D43872E051	Cat.ZC Pelle Churchill <i>Cat.ZC Leather Churchill</i>	8.800,00	

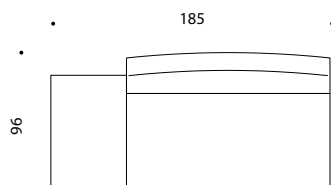

PER LA SCELTA DEI TESSUTI E PELLI CONSULTARE IL LIBRO "ABBINAMENTO TESSUTI-PELLI/MATERIALI"

FOR THE CHOICE OF FABRICS AND LEATHERS, SEE BOOK "MATCHING FABRICS-LEATHERS/MATERIALS"

NEIL by Ludovica + Roberto Palomba, 2018

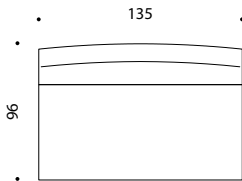
Modello Model	Codice Code	Categoria materiale - Descrizione materiale Material category - Material description	Prezzo Retail con Iva Retail price with Vat
<p>Elemento centrale L. 135 L. 135 P. 96 H. 75; seduta H. 42</p> <p>Central element W. 135 W. 135 D. 96 H. 75; seat H. 42</p> 	D43355M700	Cat.A Cotone Bonifacio <i>Cat.A Cotton Bonifacio</i>	3.950,00
	D43355M701	Cat.A Poliestere Marsiglia <i>Cat.A Polyester Marsiglia</i>	
	D43355M702	Cat.A misto Poliestere, Acrilico, Cotone Petra <i>Cat.A mixed Polyester, Acrylic, Cotton Petra</i>	
	D43355M703	Cat.A misto Poliestere, Acrilico, Cotone Damasco <i>Cat.A mixed Polyester, Acrylic, Cotton Damasco</i>	
	D43355M704	Cat.B misto Poliestere, Acrilico, Cotone Berlino <i>Cat.B mixed Polyester, Acrylic, Cotton Berlino</i>	4.350,00
	D43355M705	Cat.B Poliestere Jakarta <i>Cat.B Polyester Jakarta</i>	
	D43355M706	Cat.B Poliestere Ginevra <i>Cat.B Polyester Ginevra</i>	
	D43355M032	Cat.C Velluto di cotone Loira <i>Cat.C Cotton Velvet Loira</i>	4.550,00
	D43355M036	Cat.C Misto Lino Lisbona <i>Cat.C Linen Mix Lisbona</i>	
	D43355M040	Cat.C Lino Barcellona <i>Cat.C Linen Barcellona</i>	
	D43355M709	Cat.C Polipropilene Amburgo <i>Cat.C Polypropylene Amburgo</i>	
	D43355M710	Cat.C misto Poliestere, Acrilico, Cotone, Lana, Viscosa Berna <i>Cat.C mixed Polyester, Acrylic, Cotton, Wool, Viscose Berna</i>	
	D43355M712	Cat.D Lana vergine, Cotone, Poliammide Malmö <i>Cat.D virgin Wool, Cotton, Polyamide Malmö</i>	4.950,00
	D43355M713	Cat.E Lana Divina Melange Kvadrat <i>Cat.E Wool Divina Melange Kvadrat</i>	5.150,00
	D43355M714	Cat.E Cotone Venezia <i>Cat.E Cotton Venezia</i>	
	D43355M050	Cat.P Pelle Niagara <i>Cat.P Leather Niagara</i>	5.050,00
	D43355M049	Cat.O Pelle Rio <i>Cat.O Leather Rio</i>	5.500,00
	D43355M052	Cat.ZME Pelle Amur <i>Cat.ZME Leather Amur</i>	5.900,00
D43355M054	Cat.ZA Pelle Purus <i>Cat.ZA Leather Purus</i>	6.300,00	
D43355M051	Cat.ZC Pelle Churchill <i>Cat.ZC Leather Churchill</i>	7.300,00	

PER LA SCELTA DEI TESSUTI E PELLI CONSULTARE IL LIBRO "ABBINAMENTO TESSUTI-PELLI/MATERIALI"

FOR THE CHOICE OF FABRICS AND LEATHERS, SEE BOOK "MATCHING FABRICS-LEATHERS/MATERIALS"

REVER

by Ludovica+Roberto

Palomba

2017

Divani componibili

Struttura in legno dotata di cinghiatura elastica e imbottitura in schiume poliuretaniche a quote differenziate. Rivestimento sfoderabile in tessuto o fisso in pelle. Uso solo interno. CUSCINI DECORATIVI A PAG.184

Sectional sofas

Wooden frame with elastic belting and padding in polyurethane foams with different densities. Removable cover in fabric or fixed in leather. Indoor use only. THROW CUSHIONS PAGE 184

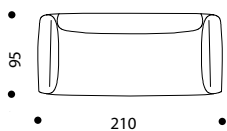

Divano 3 posti/
Three-seater sofa

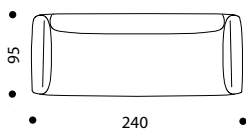

Divano 4 posti/
Four-seater sofa

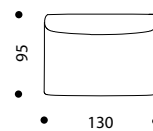

Elemento centrale/
Central element

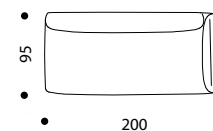

Elemento terminale destro/
Closing right element

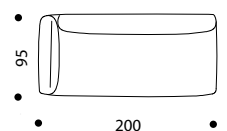

Elemento terminale sinistro/
Closing left element

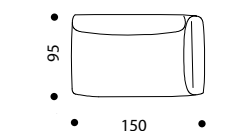

Elemento angolare destro/
Corner right element

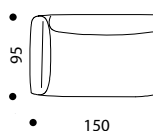

Elemento angolare sinistro/
Corner left element

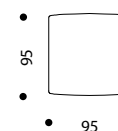

Pouf/
Ottoman

🔥 Disponibile la versione ignifuga BS 5852 Domestic con maggiorazione del 15% solo per tessuti e pelli contrassegnati con *. Uso solo interno.
Tessuto Cliente consentito, si prega di fare riferimento al nostro servizio clienti.
Available the flame retardant version BS 5852 Domestic with 15% surcharge only for fabrics and leathers marked with *. Indoor use only.
COM and COL allowed, please refer to our Customer Service.

REVER by Ludovica + Roberto Palomba, 2017

Modello Model	Codice Code	Categoria materiale - Descrizione materiale Material category - Material description	Prezzo Retail con Iva Retail price with Vat
Divano 3 posti L. 210 P. 95 H. 66; seduta H. 40; P.L. 60 Kg; V. 2 mc Three-seater sofa W. 210 D. 95 H. 66; seat H. 40; G.W. 60 Kg; V. 2 cbm	D42606C700	Cat.A Cotone Bonifacio * Cat.A Cotton Bonifacio *	3.700,00
	D42606C701	Cat.A Poliestere Marsiglia Cat.A Polyester Marsiglia	
	D42606C702	Cat.A misto Poliestere, Acrilico, Cotone Petra Cat.A mixed Polyester, Acrylic, Cotton Petra	
	D42606C703	Cat.A misto Poliestere, Acrilico, Cotone Damasco Cat.A mixed Polyester, Acrylic, Cotton Damasco	
	D42606C704	Cat.B misto Poliestere, Acrilico, Cotone Berlino * Cat.B mixed Polyester, Acrylic, Cotton Berlino *	3.950,00
	D42606C705	Cat.B Poliestere Jakarta Cat.B Polyester Jakarta	
	D42606C706	Cat.B Poliestere Ginevra Cat.B Polyester Ginevra	
	D42606C032	Cat.C Velluto di cotone Loira * Cat.C Cotton Velvet Loira *	4.350,00
	D42606C036	Cat.C Misto Lino Lisbona Cat.C Linen Mix Lisbona	
	D42606C040	Cat.C Lino Barcellona * Cat.C Linen Barcellona *	
D42606C709	Cat.C Polipropilene Amburgo * Cat.C Polypropylene Amburgo *		
D42606C710	Cat.C misto Poliestere, Acrilico, Cotone, Lana, Viscosa Berna * Cat.C mixed Polyester, Acrylic, Cotton, Wool, Viscose Berna *		
D42606C712	Cat.D Lana vergine, Cotone, Poliammide Malmö Cat.D virgin Wool, Cotton, Polyamide Malmö	4.800,00	
D42606C713	Cat.E Lana Divina Melange Kvadrat * Cat.E Wool Divina Melange Kvadrat *	5.990,00	
D42606C714	Cat.E Cotone Venezia Cat.E Cotton Venezia		
D42606C050	Cat.P Pelle Niagara * Cat.P Leather Niagara *	5.900,00	
D42606C049	Cat.O Pelle Rio * Cat.O Leather Rio *	6.850,00	
D42606C054	Cat.ZA Pelle Purus * Cat.ZA Leather Purus *	8.350,00	
D42606C051	Cat.ZC Pelle Churchill * Cat.ZC Leather Churchill *	9.700,00	

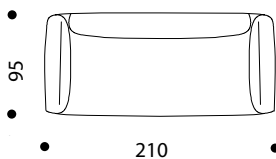

PER LA SCELTA DEI TESSUTI E PELLI CONSULTARE IL LIBRO "ABBINAMENTO TESSUTI-PELLI/MATERIALI"

FOR THE CHOICE OF FABRICS AND LEATHERS, SEE BOOK "MATCHING FABRICS-LEATHERS/MATERIALS"

REVER by Ludovica + Roberto Palomba, 2017

Modello Model	Codice Code	Categoria materiale - Descrizione materiale Material category - Material description	Prezzo Retail con Iva Retail price with Vat
Divano 4 posti L. 240 P. 95 H. 66; seduta H. 40; P.L. 70 Kg; V. 2,20 mc Four-seater sofa W. 240 D. 95 H. 66; seat H. 40; G.W. 70 Kg; V. 2,20 cbm	D42609C700	Cat.A Cotone Bonifacio * Cat.A Cotton Bonifacio *	4.150,00
	D42609C701	Cat.A Poliestere Marsiglia Cat.A Polyester Marsiglia	
	D42609C702	Cat.A misto Poliestere, Acrilico, Cotone Petra Cat.A mixed Polyester, Acrylic, Cotton Petra	
	D42609C703	Cat.A misto Poliestere, Acrilico, Cotone Damasco Cat.A mixed Polyester, Acrylic, Cotton Damasco	
	D42609C704	Cat.B misto Poliestere, Acrilico, Cotone Berlino * Cat.B mixed Polyester, Acrylic, Cotton Berlino *	4.450,00
	D42609C705	Cat.B Poliestere Jakarta Cat.B Polyester Jakarta	
	D42609C706	Cat.B Poliestere Ginevra Cat.B Polyester Ginevra	
	D42609C032	Cat.C Velluto di cotone Loira * Cat.C Cotton Velvet Loira *	4.890,00
	D42609C036	Cat.C Misto Lino Lisbona Cat.C Linen Mix Lisbona	
	D42609C040	Cat.C Lino Barcellona * Cat.C Linen Barcellona *	
D42609C709	Cat.C Polipropilene Amburgo * Cat.C Polypropylene Amburgo *		
D42609C710	Cat.C misto Poliestere, Acrilico, Cotone, Lana, Viscosa Berna * Cat.C mixed Polyester, Acrylic, Cotton, Wool, Viscose Berna *		
D42609C712	Cat.D Lana vergine, Cotone, Poliammide Malmö Cat.D virgin Wool, Cotton, Polyamide Malmö	5.350,00	
D42609C713	Cat.E Lana Divina Melange Kvadrat * Cat.E Wool Divina Melange Kvadrat *	6.450,00	
D42609C714	Cat.E Cotone Venezia Cat.E Cotton Venezia		
D42609C050	Cat.P Pelle Niagara * Cat.P Leather Niagara *	6.350,00	
D42609C049	Cat.O Pelle Rio * Cat.O Leather Rio *	7.350,00	
D42609C054	Cat.ZA Pelle Purus * Cat.ZA Leather Purus *	8.600,00	
D42609C051	Cat.ZC Pelle Churchill * Cat.ZC Leather Churchill *	10.100,00	

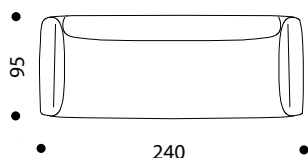

PER LA SCELTA DEI TESSUTI E PELLI CONSULTARE IL LIBRO "ABBINAMENTO TESSUTI-PELLI/MATERIALI"

FOR THE CHOICE OF FABRICS AND LEATHERS, SEE BOOK "MATCHING FABRICS-LEATHERS/MATERIALS"

REVER by Ludovica + Roberto Palomba, 2017

Modello Model	Codice Code	Categoria materiale - Descrizione materiale Material category - Material description	Prezzo Retail con Iva Retail price with Vat
Elemento centrale L. 130 P. 95 H. 66; seduta H. 40; P.L. 35 Kg; V. 1,20 mc Central element W. 130 D. 95 H. 66; seat H. 40; G.W. 35 Kg; V. 1,20 cbm	D42609C700	Cat.A Cotone Bonifacio * Cat.A Cotton Bonifacio *	2.450,00
	D42609C701	Cat.A Poliestere Marsiglia Cat.A Polyester Marsiglia	
	D42609C702	Cat.A misto Poliestere, Acrilico, Cotone Petra Cat.A mixed Polyester, Acrylic, Cotton Petra	
	D42609C703	Cat.A misto Poliestere, Acrilico, Cotone Damasco Cat.A mixed Polyester, Acrylic, Cotton Damasco	
	D42609C704	Cat.B misto Poliestere, Acrilico, Cotone Berlino * Cat.B mixed Polyester, Acrylic, Cotton Berlino *	2.660,00
	D42609C705	Cat.B Poliestere Jakarta Cat.B Polyester Jakarta	
	D42609C706	Cat.B Poliestere Ginevra Cat.B Polyester Ginevra	
	D42609C032	Cat.C Velluto di cotone Loira * Cat.C Cotton Velvet Loira *	2.900,00
	D42609C036	Cat.C Misto Lino Lisbona Cat.C Linen Mix Lisbona	
	D42609C040	Cat.C Lino Barcellona * Cat.C Linen Barcellona *	
D42609C709	Cat.C Polipropilene Amburgo * Cat.C Polypropylene Amburgo *		
D42609C710	Cat.C misto Poliestere, Acrilico, Cotone, Lana, Viscosa Berna * Cat.C mixed Polyester, Acrylic, Cotton, Wool, Viscose Berna *		
D42609C712	Cat.D Lana vergine, Cotone, Poliammide Malmö Cat.D virgin Wool, Cotton, Polyamide Malmö	3.200,00	
D42609C713	Cat.E Lana Divina Melange Kvadrat * Cat.E Wool Divina Melange Kvadrat *	3.500,00	
D42609C714	Cat.E Cotone Venezia Cat.E Cotton Venezia		
D42609C050	Cat.P Pelle Niagara * Cat.P Leather Niagara *	3.400,00	
D42609C049	Cat.O Pelle Rio * Cat.O Leather Rio *	3.900,00	
D42609C054	Cat.ZA Pelle Purus * Cat.ZA Leather Purus *	4.500,00	
D42609C051	Cat.ZC Pelle Churchill * Cat.ZC Leather Churchill *	5.300,00	

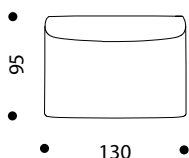

PER LA SCELTA DEI TESSUTI E PELLI CONSULTARE IL LIBRO "ABBINAMENTO TESSUTI-PELLI/MATERIALI"

FOR THE CHOICE OF FABRICS AND LEATHERS, SEE BOOK "MATCHING FABRICS-LEATHERS/MATERIALS"

REVER by Ludovica + Roberto Palomba, 2017

Modello Model	Codice Code	Categoria materiale - Descrizione materiale Material category - Material description	Prezzo Retail con Iva Retail price with Vat
<p>Elemento terminale destro L. 200 P. 95 H. 66; seduta H. 40; P.L. 55 Kg; V. 2 mc</p> <p>Closing right element W. 200 D. 95 H. 66; seat H. 40; G.W. 55 Kg; V. 2 cbm</p> 	D42621E700	Cat.A Cotone Bonifacio * Cat.A Cotton Bonifacio *	3.400,00
	D42621E701	Cat.A Poliestere Marsiglia Cat.A Polyester Marsiglia	
	D42621E702	Cat.A misto Poliestere, Acrilico, Cotone Petra Cat.A mixed Polyester, Acrylic, Cotton Petra	
	D42621E703	Cat.A misto Poliestere, Acrilico, Cotone Damasco Cat.A mixed Polyester, Acrylic, Cotton Damasco	
	D42621E704	Cat.B misto Poliestere, Acrilico, Cotone Berlino * Cat.B mixed Polyester, Acrylic, Cotton Berlino *	3.700,00
	D42621E705	Cat.B Poliestere Jakarta Cat.B Polyester Jakarta	
	D42621E706	Cat.B Poliestere Ginevra Cat.B Polyester Ginevra	
	D42621E032	Cat.C Velluto di cotone Loira * Cat.C Cotton Velvet Loira *	4.050,00
	D42621E036	Cat.C Misto Lino Lisbona Cat.C Linen Mix Lisbona	
	D42621E040	Cat.C Lino Barcellona * Cat.C Linen Barcellona *	
	D42621E709	Cat.C Polipropilene Amburgo * Cat.C Polypropylene Amburgo *	
	D42621E710	Cat.C misto Poliestere, Acrilico, Cotone, Lana, Viscosa Berna * Cat.C mixed Polyester, Acrylic, Cotton, Wool, Viscose Berna *	
	D42621E712	Cat.D Lana vergine, Cotone, Poliammide Malmö Cat.D virgin Wool, Cotton, Polyamide Malmö	4.350,00
	D42621E713	Cat.E Lana Divina Melange Kvadrat * Cat.E Wool Divina Melange Kvadrat *	5.490,00
	D42621E714	Cat.E Cotone Venezia Cat.E Cotton Venezia	
D42621E050	Cat.P Pelle Niagara * Cat.P Leather Niagara *	5.390,00	
D42621E049	Cat.O Pelle Rio * Cat.O Leather Rio *	6.100,00	
D42621E054	Cat.ZA Pelle Purus * Cat.ZA Leather Purus *	7.350,00	
D42621E051	Cat.ZC Pelle Churchill * Cat.ZC Leather Churchill *	8.850,00	

PER LA SCELTA DEI TESSUTI E PELLI CONSULTARE IL LIBRO "ABBINAMENTO TESSUTI-PELLI/MATERIALI"

FOR THE CHOICE OF FABRICS AND LEATHERS, SEE BOOK "MATCHING FABRICS-LEATHERS/MATERIALS"

REVER by Ludovica + Roberto Palomba, 2017

Modello Model	Codice Code	Categoria materiale - Descrizione materiale Material category - Material description	Prezzo Retail con Iva Retail price with Vat
Elemento terminale sinistro L. 200 P. 95 H. 66; seduta H. 40; P.L. 55 Kg; V. 2 mc Closing left element W. 200 D. 95 H. 66; seat H. 40; G.W. 55 Kg; V. 2 cbm	D42622E700	Cat.A Cotone Bonifacio * Cat.A Cotton Bonifacio *	3.400,00
	D42622E701	Cat.A Poliestere Marsiglia Cat.A Polyester Marsiglia	
	D42622E702	Cat.A misto Poliestere, Acrilico, Cotone Petra Cat.A mixed Polyester, Acrylic, Cotton Petra	
	D42622E703	Cat.A misto Poliestere, Acrilico, Cotone Damasco Cat.A mixed Polyester, Acrylic, Cotton Damasco	
	D42622E704	Cat.B misto Poliestere, Acrilico, Cotone Berlino * Cat.B mixed Polyester, Acrylic, Cotton Berlino *	3.700,00
	D42622E705	Cat.B Poliestere Jakarta Cat.B Polyester Jakarta	
	D42622E706	Cat.B Poliestere Ginevra Cat.B Polyester Ginevra	
	D42622E032	Cat.C Velluto di cotone Loira * Cat.C Cotton Velvet Loira *	4.050,00
	D42622E036	Cat.C Misto Lino Lisbona Cat.C Linen Mix Lisbona	
	D42622E040	Cat.C Lino Barcellona * Cat.C Linen Barcellona *	
D42622E709	Cat.C Polipropilene Amburgo * Cat.C Polypropylene Amburgo *		
D42622E710	Cat.C misto Poliestere, Acrilico, Cotone, Lana, Viscosa Berna * Cat.C mixed Polyester, Acrylic, Cotton, Wool, Viscose Berna *		
D42622E712	Cat.D Lana vergine, Cotone, Poliammide Malmö Cat.D virgin Wool, Cotton, Polyamide Malmö	4.350,00	
D42622E713	Cat.E Lana Divina Melange Kvadrat * Cat.E Wool Divina Melange Kvadrat *	5.490,00	
D42622E714	Cat.E Cotone Venezia Cat.E Cotton Venezia		
D42622E050	Cat.P Pelle Niagara * Cat.P Leather Niagara *	5.390,00	
D42622E049	Cat.O Pelle Rio * Cat.O Leather Rio *	6.100,00	
D42622E054	Cat.ZA Pelle Purus * Cat.ZA Leather Purus *	7.350,00	
D42622E051	Cat.ZC Pelle Churchill * Cat.ZC Leather Churchill *	8.850,00	

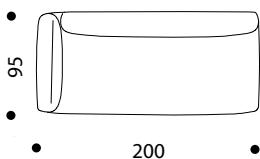

PER LA SCELTA DEI TESSUTI E PELLI CONSULTARE IL LIBRO "ABBINAMENTO TESSUTI-PELLI/MATERIALI"

FOR THE CHOICE OF FABRICS AND LEATHERS, SEE BOOK "MATCHING FABRICS-LEATHERS/MATERIALS"

REVER by Ludovica + Roberto Palomba, 2017

Modello Model	Codice Code	Categoria materiale - Descrizione materiale Material category - Material description	Prezzo Retail con Iva Retail price with Vat
Elemento angolare destro L. 150 P. 95 H. 66; seduta H. 40; P.L. 50 Kg; V. 1,70 mc Corner right element W. 150 D. 95 H. 66; seat H. 40; G.W.. 50 Kg; V. 1,70 cbm	D42647D700	Cat.A Cotone Bonifacio * Cat.A Cotton Bonifacio *	3.050,00
	D42647D701	Cat.A Poliestere Marsiglia Cat.A Polyester Marsiglia	
	D42647D702	Cat.A misto Poliestere, Acrilico, Cotone Petra Cat.A mixed Polyester, Acrylic, Cotton Petra	
	D42647D703	Cat.A misto Poliestere, Acrilico, Cotone Damasco Cat.A mixed Polyester, Acrylic, Cotton Damasco	
	D42647D704	Cat.B misto Poliestere, Acrilico, Cotone Berlino * Cat.B mixed Polyester, Acrylic, Cotton Berlino *	3.290,00
	D42647D705	Cat.B Poliestere Jakarta Cat.B Polyester Jakarta	
	D42647D706	Cat.B Poliestere Ginevra Cat.B Polyester Ginevra	
	D42647D032	Cat.C Velluto di cotone Loira * Cat.C Cotton Velvet Loira *	3.650,00
	D42647D036	Cat.C Misto Lino Lisbona Cat.C Linen Mix Lisbona	
	D42647D040	Cat.C Lino Barcellona * Cat.C Linen Barcellona *	
D42647D709	Cat.C Polipropilene Amburgo * Cat.C Polypropylene Amburgo *		
D42647D710	Cat.C misto Poliestere, Acrilico, Cotone, Lana, Viscosa Berna * Cat.C mixed Polyester, Acrylic, Cotton, Wool, Viscose Berna *		
D42647D712	Cat.D Lana vergine, Cotone, Poliammide Malmö Cat.D virgin Wool, Cotton, Polyamide Malmö	3.980,00	
D42647D713	Cat.E Lana Divina Melange Kvadrat * Cat.E Wool Divina Melange Kvadrat *	4.390,00	
D42647D714	Cat.E Cotone Venezia Cat.E Cotton Venezia		
D42647D050	Cat.P Pelle Niagara * Cat.P Leather Niagara *	4.290,00	
D42647D049	Cat.O Pelle Rio * Cat.O Leather Rio *	4.890,00	
D42647D054	Cat.ZA Pelle Purus * Cat.ZA Leather Purus *	5.890,00	
D42647D051	Cat.ZC Pelle Churchill * Cat.ZC Leather Churchill *	6.850,00	

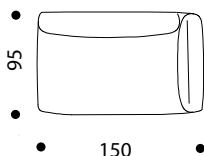

PER LA SCELTA DEI TESSUTI E PELLI CONSULTARE IL LIBRO "ABBINAMENTO TESSUTI-PELLI/MATERIALI"

FOR THE CHOICE OF FABRICS AND LEATHERS, SEE BOOK "MATCHING FABRICS-LEATHERS/MATERIALS"

REVER by Ludovica + Roberto Palomba, 2017

Modello Model	Codice Code	Categoria materiale - Descrizione materiale Material category - Material description	Prezzo Retail con Iva Retail price with Vat
Elemento angolare sinistro L. 150 P. 95 H. 66; seduta H. 40; P.L. 50 Kg; V. 1,70 mc Corner left element W. 150 D. 95 H. 66; seat H. 40; G.W.. 50 Kg; V. 1,70 cbm	D42648D700	Cat.A Cotone Bonifacio * Cat.A Cotton Bonifacio *	3.050,00
	D42648D701	Cat.A Poliestere Marsiglia Cat.A Polyester Marsiglia	
	D42648D702	Cat.A misto Poliestere, Acrilico, Cotone Petra Cat.A mixed Polyester, Acrylic, Cotton Petra	
	D42648D703	Cat.A misto Poliestere, Acrilico, Cotone Damasco Cat.A mixed Polyester, Acrylic, Cotton Damasco	
	D42648D704	Cat.B misto Poliestere, Acrilico, Cotone Berlino * Cat.B mixed Polyester, Acrylic, Cotton Berlino *	3.290,00
	D42648D705	Cat.B Poliestere Jakarta Cat.B Polyester Jakarta	
	D42648D706	Cat.B Poliestere Ginevra Cat.B Polyester Ginevra	
	D42648D032	Cat.C Velluto di cotone Loira * Cat.C Cotton Velvet Loira *	3.650,00
	D42648D036	Cat.C Misto Lino Lisbona Cat.C Linen Mix Lisbona	
	D42648D040	Cat.C Lino Barcellona * Cat.C Linen Barcellona *	
D42648D709	Cat.C Polipropilene Amburgo * Cat.C Polypropylene Amburgo *		
D42648D710	Cat.C misto Poliestere, Acrilico, Cotone, Lana, Viscosa Berna * Cat.C mixed Polyester, Acrylic, Cotton, Wool, Viscose Berna *		
D42648D712	Cat.D Lana vergine, Cotone, Poliammide Malmö Cat.D virgin Wool, Cotton, Polyamide Malmö	3.980,00	
D42648D713	Cat.E Lana Divina Melange Kvadrat * Cat.E Wool Divina Melange Kvadrat *	4.390,00	
D42648D714	Cat.E Cotone Venezia Cat.E Cotton Venezia		
D42648D050	Cat.P Pelle Niagara * Cat.P Leather Niagara *	4.290,00	
D42648D049	Cat.O Pelle Rio * Cat.O Leather Rio *	4.890,00	
D42648D054	Cat.ZA Pelle Purus * Cat.ZA Leather Purus *	5.890,00	
D42648D051	Cat.ZC Pelle Churchill * Cat.ZC Leather Churchill *	6.850,00	

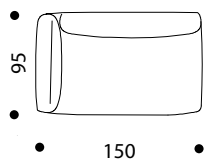

PER LA SCELTA DEI TESSUTI E PELLI CONSULTARE IL LIBRO "ABBINAMENTO TESSUTI-PELLI/MATERIALI"

FOR THE CHOICE OF FABRICS AND LEATHERS, SEE BOOK "MATCHING FABRICS-LEATHERS/MATERIALS"

REVER by Ludovica + Roberto Palomba, 2017

Modello Model	Codice Code	Categoria materiale - Descrizione materiale Material category - Material description	Prezzo Retail con Iva Retail price with Vat
Pouf L. 95 P. 95 H. 40; P.L. 25 Kg; V. 0,80 mc Ottoman W. 95 D. 95 H. 40; G.W.. 25 Kg; V. 0,80 cbm	D42710C700	Cat.A Cotone Bonifacio * Cat.A Cotton Bonifacio *	1.300,00
	D42710C701	Cat.A Poliestere Marsiglia Cat.A Polyester Marsiglia	
	D42710C702	Cat.A misto Poliestere, Acrilico, Cotone Petra Cat.A mixed Polyester, Acrylic, Cotton Petra	
	D42710C703	Cat.A misto Poliestere, Acrilico, Cotone Damasco Cat.A mixed Polyester, Acrylic, Cotton Damasco	
	D42710C704	Cat.B misto Poliestere, Acrilico, Cotone Berlino * Cat.B mixed Polyester, Acrylic, Cotton Berlino *	1.450,00
	D42710C705	Cat.B Poliestere Jakarta Cat.B Polyester Jakarta	
	D42710C706	Cat.B Poliestere Ginevra Cat.B Polyester Ginevra	
	D42710C032	Cat.C Velluto di cotone Loira * Cat.C Cotton Velvet Loira *	1.550,00
	D42710C036	Cat.C Misto Lino Lisbona Cat.C Linen Mix Lisbona	
	D42710C040	Cat.C Lino Barcellona * Cat.C Linen Barcellona *	
D42710C709	Cat.C Polipropilene Amburgo * Cat.C Polypropylene Amburgo *		
D42710C710	Cat.C misto Poliestere, Acrilico, Cotone, Lana, Viscosa Berna * Cat.C mixed Polyester, Acrylic, Cotton, Wool, Viscose Berna *		
D42710C712	Cat.D Lana vergine, Cotone, Poliammide Malmö Cat.D virgin Wool, Cotton, Polyamide Malmö	1.650,00	
D42710C713	Cat.E Lana Divina Melange Kvadrat * Cat.E Wool Divina Melange Kvadrat *	1.990,00	
D42710C714	Cat.E Cotone Venezia Cat.E Cotton Venezia		
D42710C050	Cat.P Pelle Niagara * Cat.P Leather Niagara *	1.900,00	
D42710C049	Cat.O Pelle Rio * Cat.O Leather Rio *	2.200,00	
D42710C054	Cat.ZA Pelle Purus * Cat.ZA Leather Purus *	2.600,00	
D42710C051	Cat.ZC Pelle Churchill * Cat.ZC Leather Churchill *	2.700,00	

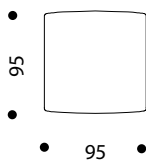

PER LA SCELTA DEI TESSUTI E PELLI CONSULTARE IL LIBRO "ABBINAMENTO TESSUTI-PELLI/MATERIALI"

FOR THE CHOICE OF FABRICS AND LEATHERS, SEE BOOK "MATCHING FABRICS-LEATHERS/MATERIALS"

TOTTORI

by Kateryna Sokolova
2021

Divanetto

Struttura in poliuretano flessibile a media densità, piedini in PE per l'appoggio a terra. Il rivestimento è fisso con la possibilità di materiali differenti per le gambe rispetto a quelli di seduta e schienale. Uso solo interno.

Sofa

Structure in medium density flexible polyurethane, PE feet for ground support. The cover is fixed with the possibility of different materials for the legs than those of the seat and back. Indoor use only.

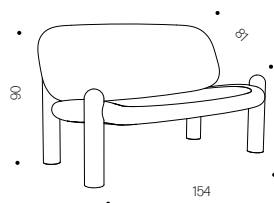

Divano/
Sofa

 Disponibile la versione ignifuga BS 5852 Domestic con maggiorazione del 10% solo per tessuti e pelli contrassegnati con *. Uso solo interno.

Tessuto Cliente consentito, si prega di fare riferimento al nostro servizio clienti.

Ordine minimo: 4 pezzi.

Available the flame retardant version BS 5852 Domestic with 10% surcharge only for fabrics and leathers marked with *. Indoor use only.

COM and COL allowed, please refer to our Customer Service.

Minimum Order: 4 pcs

TOTTORI by Kateryna Sokolova, 2021

Modello Model	Codice Code	Categoria materiale - Descrizione materiale Material category - Material description	Prezzo Retail con Iva Retail price with Vat
Divano L. 154 P. 81 H. 90; seduta H. 43; P.L. 50,5 Kg; V. 1,257 mc Sofa W. 154 D. 81 H. 90; seat H. 43; G.W. 50,5 Kg; V. 1,257 cbm 	DA5656C700	Cat.A Cotone Bonifacio * Cat.A Cotton Bonifacio *	2.500,00
	DA5656C701	Cat.A Poliestere Marsiglia Cat.A Polyester Marsiglia	
	DA5656C702	Cat.A misto Poliestere, Acrilico, Cotone Petra Cat.A mixed Polyester, Acrylic, Cotton Petra	
	DA5656C703	Cat.A misto Poliestere, Acrilico, Cotone Damasco Cat.A mixed Polyester, Acrylic, Cotton Damasco	
	DA5656C704	Cat.B misto Poliestere, Acrilico, Cotone Berlino * Cat.B mixed Polyester, Acrylic, Cotton Berlino *	2.800,00
	DA5656C705	Cat.B Poliestere Jakarta Cat.B Polyester Jakarta	
	DA5656C706	Cat.B Poliestere Ginevra Cat.B Polyester Ginevra	
	DA5656C036	Cat.C Misto Lino Lisbona Cat.C Linen Mix Lisbona	2.950,00
	DA5656C040	Cat.C Lino Barcellona * Cat.C Linen Barcellona *	
	DA5656C709	Cat.C Polipropilene Amburgo * Cat.C Polypropylene Amburgo *	
	DA5656C710	Cat.C misto Poliestere, Acrilico, Cotone, Lana, Viscosa Berna * Cat.C mixed Polyester, Acrylic, Cotton, Wool, Viscose Berna *	
	DA5656C712	Cat.D Lana vergine, Cotone, Poliammide Malmö Cat.D virgin Wool, Cotton, Polyamide Malmö	3.200,00
	DA5656C713	Cat.E Lana Divina Melange Kvadrat * Cat.E Wool Divina Melange Kvadrat *	3.500,00
	DA5656C049	Cat.O Pelle Rio * Cat.O Leather Rio *	3.730,00
	DA5656C052	Cat.ZME Pelle Amur * Cat.ZME Leather Amur *	3.950,00
DA5656C054	Cat.ZA Pelle Purus * Cat.ZA Leather Purus *	4.290,00	
DA5656C051	Cat.ZC Pelle Churchill * Cat.ZC Leather Churchill *	4.950,00	

PER LA SCELTA DEI TESSUTI E PELLI CONSULTARE IL LIBRO "ABBINAMENTO TESSUTI-PELLI/MATERIALI"

FOR THE CHOICE OF FABRICS AND LEATHERS, SEE BOOK "MATCHING FABRICS-LEATHERS/MATERIALS"

VERLAINE

by Lievore Altherr Molina
2014

Divano destro o sinistro

Struttura in Polimex e mdf, imbottiture in schiume poliuretaniche a densità differenziata, piedi in legno. Rivestimento sfoderabile in velluto, tessuto o pelle. Rivestimento tessuto cliente: quotazione e tempi di consegna da definire all'atto della richiesta. I divani comprendono un cuscino poggiatesta in misto piuma sfoderabile. Uso solo interno.

Right or left sofa

Polimex and MDF structure, different densities polyurethane foams padding and wooden feet. Velvet, fabric or leather removable cover. COM or COL cover: Pricing and delivery time to be agreed on demand. Sofas will be equipped with a back cushion with a removable cover. Indoor use only.

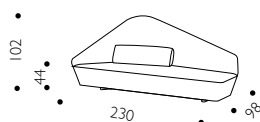

Divano L. 230/
Sofa W. 230

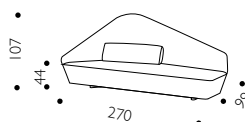

Divano L. 270/
Sofa W. 270

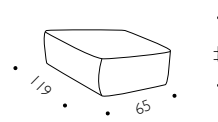

Pouf/
Ottoman

VERLAINE by Lievore Altherr Molina, 2014

Modello Model	Codice Code	Categoria materiale - Descrizione materiale Material category - Material description	Prezzo Retail con Iva Retail price with Vat
Divano destro L. 230 P. 98 H. 102; seduta H. 44; P.L. 76 Kg; V. 3,15 mc Right sofa W. 230 D. 98 H. 102; seat H. 44; G.W.. 76 Kg; V. 3,15 cbm	D83051Z700	Cat.A Cotone Bonifacio <i>Cat.A Cotton Bonifacio</i>	5.900,00
	D83051Z701	Cat.A Poliestere Marsiglia <i>Cat.A Polyester Marsiglia</i>	
	D83051Z702	Cat.A misto Poliestere, Acrilico, Cotone Petra <i>Cat.A mixed Polyester, Acrylic, Cotton Petra</i>	
	D83051Z703	Cat.A misto Poliestere, Acrilico, Cotone Damasco <i>Cat.A mixed Polyester, Acrylic, Cotton Damasco</i>	
	D83051Z704	Cat.B misto Poliestere, Acrilico, Cotone Berlino <i>Cat.B mixed Polyester, Acrylic, Cotton Berlino</i>	6.150,00
	D83051Z705	Cat.B Poliestere Jakarta <i>Cat.B Polyester Jakarta</i>	
	D83051Z706	Cat.B Poliestere Ginevra <i>Cat.B Polyester Ginevra</i>	
	D83051Z032	Cat.C Velluto di cotone Loira <i>Cat.C Cotton Velvet Loira</i>	6.500,00
	D83051Z036	Cat.C Misto Lino Lisbona <i>Cat.C Linen Mix Lisbona</i>	
	D83051Z040	Cat.C Lino Barcellona <i>Cat.C Linen Barcellona</i>	
	D83051Z709	Cat.C Polipropilene Amburgo <i>Cat.C Polypropylene Amburgo</i>	
	D83051Z710	Cat.C misto Poliestere, Acrilico, Cotone, Lana, Viscosa Berna <i>Cat.C mixed Polyester, Acrylic, Cotton, Wool, Viscose Berna</i>	
	D83051Z712	Cat.D Lana vergine, Cotone, Poliammide Malmö <i>Cat.D virgin Wool, Cotton, Polyamide Malmö</i>	6.900,00
	D83051Z713	Cat.E Lana Divina Melange Kvadrat <i>Cat.E Wool Divina Melange Kvadrat</i>	6.950,00
D83051Z714	Cat.E Cotone Venezia <i>Cat.E Cotton Venezia</i>		
D83051Z050	Cat.P Pelle Niagara <i>Cat.P Leather Niagara</i>	6.850,00	
D83051Z049	Cat.O Pelle Rio <i>Cat.O Leather Rio</i>	7.700,00	
D83050O430002	Seta/Silk	Bianco/White	170,00
D83050O430039	Seta/Silk	Rosso/Red	
D83050O430016	Seta/Silk	Tortora/Greys h beige	
D83050O430073	Seta/Silk	Blu scuro/Dark blue	
D83050O430045	Seta/Silk	Grigio chiaro/Light grey	
D83050O430091	Seta/Silk	Nero/Black	
D83050O430004	Seta/Silk	Avorio/Ivory	

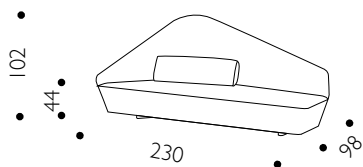

PER LA SCELTA DEI TESSUTI E PELLI CONSULTARE IL LIBRO "ABBINAMENTO TESSUTI-PELLI/MATERIALI"

FOR THE CHOICE OF FABRICS AND LEATHERS, SEE BOOK "MATCHING FABRICS-LEATHERS/MATERIALS"

VERLAINE by Lievore Altherr Molina, 2014

Modello Model	Codice Code	Categoria materiale - Descrizione materiale Material category - Material description	Prezzo Retail con Iva Retail price with Vat
Divano sinistro L. 230 P. 98 H. 102; seduta H. 44; P.L. 76 Kg; V. 3,15 mc Left sofa W. 230 D. 98 H. 102; seat H. 44; G.W.. 76 Kg; V. 3,15 cbm 	D83052Z700	Cat.A Cotone Bonifacio <i>Cat.A Cotton Bonifacio</i>	5.900,00
	D83052Z701	Cat.A Poliestere Marsiglia <i>Cat.A Polyester Marsiglia</i>	
	D83052Z702	Cat.A misto Poliestere, Acrilico, Cotone Petra <i>Cat.A mixed Polyester, Acrylic, Cotton Petra</i>	
	D83052Z703	Cat.A misto Poliestere, Acrilico, Cotone Damasco <i>Cat.A mixed Polyester, Acrylic, Cotton Damasco</i>	
	D83052Z704	Cat.B misto Poliestere, Acrilico, Cotone Berlino <i>Cat.B mixed Polyester, Acrylic, Cotton Berlino</i>	6.150,00
	D83052Z705	Cat.B Poliestere Jakarta <i>Cat.B Polyester Jakarta</i>	
	D83052Z706	Cat.B Poliestere Ginevra <i>Cat.B Polyester Ginevra</i>	
	D83052Z032	Cat.C Velluto di cotone Loira <i>Cat.C Cotton Velvet Loira</i>	6.500,00
	D83052Z036	Cat.C Misto Lino Lisbona <i>Cat.C Linen Mix Lisbona</i>	
	D83052Z040	Cat.C Lino Barcellona <i>Cat.C Linen Barcellona</i>	
	D83052Z709	Cat.C Polipropilene Amburgo <i>Cat.C Polypropylene Amburgo</i>	
	D83052Z710	Cat.C misto Poliestere, Acrilico, Cotone, Lana, Viscosa Berna <i>Cat.C mixed Polyester, Acrylic, Cotton, Wool, Viscose Berna</i>	
	D83052Z712	Cat.D Lana vergine, Cotone, Poliammide Malmö <i>Cat.D virgin Wool, Cotton, Polyamide Malmö</i>	6.900,00
	D83052Z713	Cat.E Lana Divina Melange Kvadrat <i>Cat.E Wool Divina Melange Kvadrat</i>	6.950,00
D83052Z714	Cat.E Cotone Venezia <i>Cat.E Cotton Venezia</i>		
D83052Z050	Cat.P Pelle Niagara <i>Cat.P Leather Niagara</i>	6.850,00	
D83052Z049	Cat.O Pelle Rio <i>Cat.O Leather Rio</i>	7.700,00	
D83050O430002	Seta/Silk	Bianco/White	170,00
D83050O430039	Seta/Silk	Rosso/Red	
D83050O430016	Seta/Silk	Tortora/Greys h beige	
D83050O430073	Seta/Silk	Blu scuro/Dark blue	
D83050O430045	Seta/Silk	Grigio chiaro/Light grey	
D83050O430091	Seta/Silk	Nero/Black	
D83050O430004	Seta/Silk	Avorio/Ivory	

PER LA SCELTA DEI TESSUTI E PELLI CONSULTARE IL LIBRO "ABBINAMENTO TESSUTI-PELLI/MATERIALI"

FOR THE CHOICE OF FABRICS AND LEATHERS, SEE BOOK "MATCHING FABRICS-LEATHERS/MATERIALS"

VERLAINE by Lievore Altherr Molina, 2014

Modello Model	Codice Code	Categoria materiale - Descrizione materiale Material category - Material description	Prezzo Retail con Iva Retail price with Vat
Divano destro L. 270 P. 99 H. 107; seduta H. 44; PL. 84 Kg; V. 3,67 mc Right sofa W. 270 D. 99 H. 107; seat H. 44; G.W. 84 Kg; V. 3,67 cbm 	D83003Z700	Cat.A Cotone Bonifacio <i>Cat.A Cotton Bonifacio</i>	7.050,00
	D83003Z701	Cat.A Poliestere Marsiglia <i>Cat.A Polyester Marsiglia</i>	
	D83003Z702	Cat.A misto Poliestere, Acrilico, Cotone Petra <i>Cat.A mixed Polyester, Acrylic, Cotton Petra</i>	
	D83003Z703	Cat.A misto Poliestere, Acrilico, Cotone Damasco <i>Cat.A mixed Polyester, Acrylic, Cotton Damasco</i>	
	D83003Z704	Cat.B misto Poliestere, Acrilico, Cotone Berlino <i>Cat.B mixed Polyester, Acrylic, Cotton Berlino</i>	7.700,00
	D83003Z705	Cat.B Poliestere Jakarta <i>Cat.B Polyester Jakarta</i>	
	D83003Z706	Cat.B Poliestere Ginevra <i>Cat.B Polyester Ginevra</i>	
	D83003Z032	Cat.C Velluto di cotone Loira <i>Cat.C Cotton Velvet Loira</i>	8.100,00
	D83003Z036	Cat.C Misto Lino Lisbona <i>Cat.C Linen Mix Lisbona</i>	
	D83003Z040	Cat.C Lino Barcellona <i>Cat.C Linen Barcellona</i>	
	D83003Z709	Cat.C Polipropilene Amburgo <i>Cat.C Polypropylene Amburgo</i>	
	D83003Z710	Cat.C misto Poliestere, Acrilico, Cotone, Lana, Viscosa Berna <i>Cat.C mixed Polyester, Acrylic, Cotton, Wool, Viscose Berna</i>	
	D83003Z712	Cat.D Lana vergine, Cotone, Poliammide Malmö <i>Cat.D virgin Wool, Cotton, Polyamide Malmö</i>	8.600,00
	D83003Z713	Cat.E Lana Divina Melange Kvadrat <i>Cat.E Wool Divina Melange Kvadrat</i>	9.300,00
	D83003Z714	Cat.E Cotone Venezia <i>Cat.E Cotton Venezia</i>	
	D83003Z050	Cat.P Pelle Niagara <i>Cat.P Leather Niagara</i>	9.200,00
	D83003Z049	Cat.O Pelle Rio <i>Cat.O Leather Rio</i>	10.300,00
	D83000O430002	Seta/Silk	Bianco/White
D83000O430039	Seta/Silk	Rosso/Red	
D83000O430016	Seta/Silk	Tortora/Greys h beige	
D83000O430073	Seta/Silk	Blu scuro/Dark blue	
D83000O430045	Seta/Silk	Grigio chiaro/Light grey	
D83000O430091	Seta/Silk	Nero/Black	
D83000O430004	Seta/Silk	Avorio/Ivory	

PER LA SCELTA DEI TESSUTI E PELLI CONSULTARE IL LIBRO "ABBINAMENTO TESSUTI-PELLI/MATERIALI"

FOR THE CHOICE OF FABRICS AND LEATHERS, SEE BOOK "MATCHING FABRICS-LEATHERS/MATERIALS"

VERLAINE by Lievore Altherr Molina, 2014

Modello Model	Codice Code	Categoria materiale - Descrizione materiale Material category - Material description	Prezzo Retail con Iva Retail price with Vat
Divano sinistro L. 270 P. 99 H. 107; seduta H. 44; PL. 84 Kg; V. 3,67 mc Left sofa W. 270 D. 99 H. 107; seat H. 44; G.W. 84 Kg; V. 3,67 cbm	D83004Z700	Cat.A Cotone Bonifacio <i>Cat.A Cotton Bonifacio</i>	7.050,00
	D83004Z701	Cat.A Poliestere Marsiglia <i>Cat.A Polyester Marsiglia</i>	
	D83004Z702	Cat.A misto Poliestere, Acrilico, Cotone Petra <i>Cat.A mixed Polyester, Acrylic, Cotton Petra</i>	
	D83004Z703	Cat.A misto Poliestere, Acrilico, Cotone Damasco <i>Cat.A mixed Polyester, Acrylic, Cotton Damasco</i>	
	D83004Z704	Cat.B misto Poliestere, Acrilico, Cotone Berlino <i>Cat.B mixed Polyester, Acrylic, Cotton Berlino</i>	7.700,00
	D83004Z705	Cat.B Poliestere Jakarta <i>Cat.B Polyester Jakarta</i>	
	D83004Z706	Cat.B Poliestere Ginevra <i>Cat.B Polyester Ginevra</i>	
	D83004Z032	Cat.C Velluto di cotone Loira <i>Cat.C Cotton Velvet Loira</i>	8.100,00
	D83004Z036	Cat.C Misto Lino Lisbona <i>Cat.C Linen Mix Lisbona</i>	
	D83004Z040	Cat.C Lino Barcellona <i>Cat.C Linen Barcellona</i>	
D83004Z709	Cat.C Polipropilene Amburgo <i>Cat.C Polypropylene Amburgo</i>		
D83004Z710	Cat.C misto Poliestere, Acrilico, Cotone, Lana, Viscosa Berna <i>Cat.C mixed Polyester, Acrylic, Cotton, Wool, Viscose Berna</i>		
D83004Z712	Cat.D Lana vergine, Cotone, Poliammide Malmö <i>Cat.D virgin Wool, Cotton, Polyamide Malmö</i>	8.600,00	
D83004Z713	Cat.E Lana Divina Melange Kvadrat <i>Cat.E Wool Divina Melange Kvadrat</i>	9.300,00	
D83004Z714	Cat.E Cotone Venezia <i>Cat.E Cotton Venezia</i>		
D83004Z050	Cat.P Pelle Niagara <i>Cat.P Leather Niagara</i>	9.200,00	
D83004Z049	Cat.O Pelle Rio <i>Cat.O Leather Rio</i>	10.300,00	
D83050O430002	Seta/Silk	Bianco/White	180,00
D83050O430039	Seta/Silk	Rosso/Red	
D83050O430016	Seta/Silk	Tortora/Greys h beige	
D83050O430073	Seta/Silk	Blu scuro/Dark blue	
D83050O430045	Seta/Silk	Grigio chiaro/Light grey	
D83050O430091	Seta/Silk	Nero/Black	
D83050O430004	Seta/Silk	Avorio/Ivory	

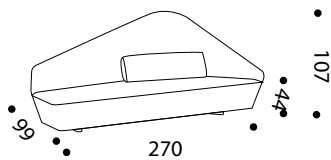

PER LA SCELTA DEI TESSUTI E PELLI CONSULTARE IL LIBRO "ABBINAMENTO TESSUTI-PELLI/MATERIALI"

FOR THE CHOICE OF FABRICS AND LEATHERS, SEE BOOK "MATCHING FABRICS-LEATHERS/MATERIALS"

VERLAINE by Lievore Altherr Molina, 2014

Modello Model	Codice Code	Categoria materiale - Descrizione materiale Material category - Material description	Prezzo Retail con Iva Retail price with Vat
Pouf L. 119 P. 65 H. 44; P.L. 18 Kg; V. 0,52 mc Ottoman W. 119 D. 65 H. 44; G.W. 18 Kg; V. 0,52 cbm	D83101C700	Cat.A Cotone Bonifacio <i>Cat.A Cotton Bonifacio</i>	2.000,00
	D83101C701	Cat.A Poliestere Marsiglia <i>Cat.A Polyester Marsiglia</i>	
	D83101C702	Cat.A misto Poliestere, Acrilico, Cotone Petra <i>Cat.A mixed Polyester, Acrylic, Cotton Petra</i>	
	D83101C703	Cat.A misto Poliestere, Acrilico, Cotone Damasco <i>Cat.A mixed Polyester, Acrylic, Cotton Damasco</i>	
	D83101C704	Cat.B misto Poliestere, Acrilico, Cotone Berlino <i>Cat.B mixed Polyester, Acrylic, Cotton Berlino</i>	2.150,00
	D83101C705	Cat.B Poliestere Jakarta <i>Cat.B Polyester Jakarta</i>	
	D83101C706	Cat.B Poliestere Ginevra <i>Cat.B Polyester Ginevra</i>	
	D83101C032	Cat.C Velluto di cotone Loira <i>Cat.C Cotton Velvet Loira</i>	2.200,00
	D83101C036	Cat.C Misto Lino Lisbona <i>Cat.C Linen Mix Lisbona</i>	
	D83101C040	Cat.C Lino Barcellona <i>Cat.C Linen Barcellona</i>	
D83101C709	Cat.C Polipropilene Amburgo <i>Cat.C Polypropylene Amburgo</i>		
D83101C710	Cat.C misto Poliestere, Acrilico, Cotone, Lana, Viscosa Berna <i>Cat.C mixed Polyester, Acrylic, Cotton, Wool, Viscose Berna</i>		
D83101C712	Cat.D Lana vergine, Cotone, Poliammide Malmö <i>Cat.D virgin Wool, Cotton, Polyamide Malmö</i>	2.350,00	
D83101C713	Cat.E Lana Divina Melange Kvadrat <i>Cat.E Wool Divina Melange Kvadrat</i>	2.500,00	
D83101C714	Cat.E Cotone Venezia <i>Cat.E Cotton Venezia</i>		
D83101C050	Cat.P Pelle Niagara <i>Cat.P Leather Niagara</i>	2.400,00	
D83101C049	Cat.O Pelle Rio <i>Cat.O Leather Rio</i>	2.600,00	

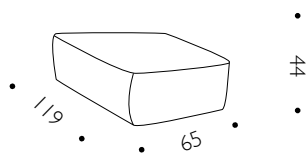

PER LA SCELTA DEI TESSUTI E PELLI CONSULTARE IL LIBRO "ABBINAMENTO TESSUTI-PELLI/MATERIALI"

FOR THE CHOICE OF FABRICS AND LEATHERS, SEE BOOK "MATCHING FABRICS-LEATHERS/MATERIALS"

VIGLIUS

by Matteo Thun &
Antonio Rodriguez
2007

Divano

Struttura in legno cinghiata. Piedi in legno di faggio laccato nero. Imbottitura in schiume poliuretaniche e ovatta. Rivestimento fisso in tessuto o pelle. Rivestimento tessuto cliente: quotazione e tempi di consegna da definire all'atto della richiesta. Uso solo interno.

Sofa

Black lacquered beechwood legs and polyurethane foams padded wooden structure with fabric or leather fixed cover. COM or COL cover: pricing and delivery time to be agreed on demand. Indoor use only.

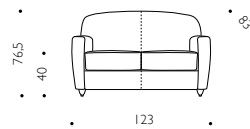

Divano 2 posti/
Two-seater sofa

VIGILIUS by Matteo Thun & Antonio Rodriguez, 2007

Modello Model	Codice Code	Categoria materiale - Descrizione materiale Material category - Material description	Prezzo Retail con Iva Retail price with Vat
Divano 2 posti L. 123 P. 83 H. 76,5; seduta H. 40; bracciolo H. 54; P.L. 42 Kg; V. 0,936 mc Two-seater sofa W. 123 D. 83 H. 76,5; seat H. 40; armrest H. 54; G.W. 54 Kg; V. 0,936 cbm	D10935C700	Cat.A Cotone Bonifacio <i>Cat.A Cotton Bonifacio</i>	2.850,00
	D10935C701	Cat.A Poliestere Marsiglia <i>Cat.A Polyester Marsiglia</i>	
	D10935C702	Cat.A misto Poliestere, Acrilico, Cotone Petra <i>Cat.A mixed Polyester, Acrylic, Cotton Petra</i>	
	D10935C703	Cat.A misto Poliestere, Acrilico, Cotone Damasco <i>Cat.A mixed Polyester, Acrylic, Cotton Damasco</i>	
	D10935C028	Cat.A Ecopelle Colorado <i>Cat.A Eco-leather Colorado</i>	
	D10935C704	Cat.B misto Poliestere, Acrilico, Cotone Berlino <i>Cat.B mixed Polyester, Acrylic, Cotton Berlino</i>	2.950,00
	D10935C705	Cat.B Poliestere Jakarta <i>Cat.B Polyester Jakarta</i>	
	D10935C706	Cat.B Poliestere Ginevra <i>Cat.B Polyester Ginevra</i>	
	D10935C032	Cat.C Velluto di cotone Loira <i>Cat.C Cotton Velvet Loira</i>	3.280,00
	D10935C036	Cat.C Misto Lino Lisbona <i>Cat.C Linen Mix Lisbona</i>	
D10935C040	Cat.C Lino Barcellona <i>Cat.C Linen Barcellona</i>		
D10935C709	Cat.C Polipropilene Amburgo <i>Cat.C Polypropylene Amburgo</i>		
D10935C710	Cat.C misto Poliestere, Acrilico, Cotone, Lana, Viscosa Berna <i>Cat.C mixed Polyester, Acrylic, Cotton, Wool, Viscose Berna</i>		
D10935C712	Cat.D Lana vergine, Cotone, Poliammide Malmö <i>Cat.D virgin Wool, Cotton, Polyamide Malmö</i>	3.550,00	
D10935C713	Cat.E Lana Divina Melange Kvadrat <i>Cat.E Wool Divina Melange Kvadrat</i>	3.900,00	
D10935C714	Cat.E Cotone Venezia <i>Cat.E Cotton Venezia</i>		
D10935C050	Cat.P Pelle Niagara <i>Cat.P Leather Niagara</i>	3.750,00	
D10935C049	Cat.O Pelle Rio <i>Cat.O Leather Rio</i>	4.290,00	
D10935C052	Cat.ZME Pelle Amur <i>Cat.ZME Leather Amur</i>	4.850,00	
D10935C054	Cat.ZA Pelle Purus <i>Cat.ZA Leather Purus</i>	5.200,00	
D10935C051	Cat.ZC Pelle Churchill <i>Cat.ZC Leather Churchill</i>	5.850,00	



PER LA SCELTA DEI TESSUTI E PELLI CONSULTARE IL LIBRO "ABBINAMENTO TESSUTI-PELLI/MATERIALI"

FOR THE CHOICE OF FABRICS AND LEATHERS, SEE BOOK "MATCHING FABRICS-LEATHERS/MATERIALS"

WOW
by Philippe Starck
2016

Divani componibili

Struttura in legno massello e pannelli in multistrato. Rivestimento sfoderabile in tessuto o in pelle. Cuscini 50x50 inclusi. Versione superior con gomme poliuretaniche, piuma d'oca e profilo di cucitura doppio. Seduta: altezza 40 cm, profondità 80 cm., schienale 98 cm. E' possibile scegliere il divano con schienale e seduta realizzati in categorie diverse di tessuti e pelli; per la quotazione finale contattare l'Ufficio Commerciale. GLI SCHIENALI POSSONO ESSERE REALIZZATI ANCHE NELLE CATEGORIE ZS E ZZ. Uso solo interno.

Per ulteriori composizioni contattare l'Ufficio Commerciale.

Sectional sofa

Solid wooden structure and plywood panels. Fabric or leather removable cover. Cushions 50x50 included. Superior version with polyurethane foams and goose feather padding and double stitching profile. Seat: height 40 cm, depth 80 cm. backrest 98 cm. It is possible to order the sofa with back and seat made in different categories of fabrics and leathers; for the price we kindly ask you to contact our Sales Department. THE BACKRESTS CAN BE SUPPLIED IN ZS AND ZZ CATEGORIES ALSO. Indoor use only.

For further compositions we kindly ask you to contact our Sales Dpt.

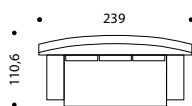

Divano 2 posti A2/
Two-seater sofa A2

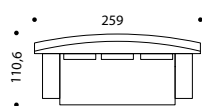

Divano 3 posti A1/
Three-seater sofa A1

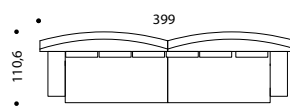

Composizione H/
Composition H

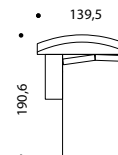

Dormeuse D1/
Dybed D1

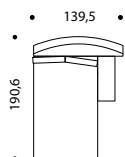

Dormeuse D2/
Dybed D2

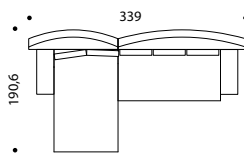

Composizione E1/
Composition E1

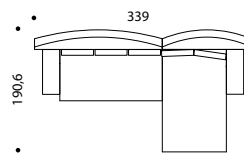

Composizione E2/
Composition E2

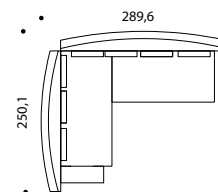

Composizione M1/
Composition M1

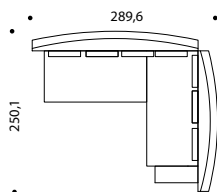

Composizione M2/
Composition M2

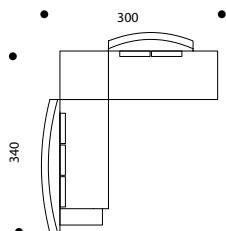

Composizione S1/
Composition S1

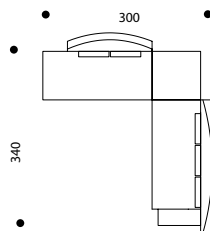

Composizione S2/
Composition S2



Pouf/
Ottoman

WOW by Philippe Starck, 2016

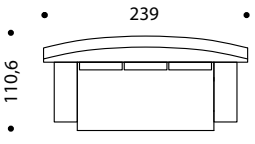
Modello Model	Codice Code	Categoria materiale - Descrizione materiale Material category - Material description	Prezzo Retail con Iva Retail price with Vat
Divano 2 posti A2 L. 239 P. 110,6 H. 98 Two-seater sofa A2 W. 239 D. 110,6 H. 98	D77005C700	Cat.A Cotone Bonifacio Cat.A Cotton Bonifacio	7.900,00
	D77005C701	Cat.A Poliestere Marsiglia Cat.A Polyester Marsiglia	
	D77005C702	Cat.A misto Poliestere, Acrilico, Cotone Petra Cat.A mixed Polyester, Acrylic, Cotton Petra	
	D77005C703	Cat.A misto Poliestere, Acrilico, Cotone Damasco Cat.A mixed Polyester, Acrylic, Cotton Damasco	
	D77005C028	Cat.A Ecopelle Colorado Cat.A Eco-leather Colorado	
	D77005C704	Cat.B misto Poliestere, Acrilico, Cotone Berlino Cat.B mixed Polyester, Acrylic, Cotton Berlino	8.500,00
	D77005C705	Cat.B Poliestere Jakarta Cat.B Polyester Jakarta	
	D77005C706	Cat.B Poliestere Ginevra Cat.B Polyester Ginevra	
	D77005C032	Cat.C Velluto di cotone Loira Cat.C Cotton Velvet Loira	8.850,00
	D77005C036	Cat.C Misto Lino Lisbona Cat.C Linen Mix Lisbona	
<p>PER LA SCELTA DEI TESSUTI E PELLI CONSULTARE IL LIBRO "ABBINAMENTO TESSUTI-PELLI/MATERIALI"</p> <p>FOR THE CHOICE OF FABRICS AND LEATHERS, SEE BOOK "MATCHING FABRICS-LEATHERS/MATERIALS"</p>	D77005C040	Cat.C Lino Barcellona Cat.C Linen Barcellona	
	D77005C709	Cat.C Polipropilene Amburgo Cat.C Polypropylene Amburgo	
	D77005C710	Cat.C misto Poliestere, Acrilico, Cotone, Lana, Viscosa Berna Cat.C mixed Polyester, Acrylic, Cotton, Wool, Viscose Berna	
	D77005C712	Cat.D Lana vergine, Cotone, Poliammide Malmö Cat.D virgin Wool, Cotton, Polyamide Malmö	9.650,00
	D77005C713	Cat.E Lana Divina Melange Kvadrat Cat.E Wool Divina Melange Kvadrat	12.100,00
D77005C714	Cat.E Cotone Venezia Cat.E Cotton Venezia		
D77005C050	Cat.P Pelle Niagara Cat.P Leather Niagara	11.800,00	
D77005C049	Cat.O Pelle Rio Cat.O Leather Rio	13.300,00	
D77005C052	Cat.ZME Pelle Amur Cat.ZME Leather Amur	15.400,00	
D77005C054	Cat.ZA Pelle Purus Cat.ZA Leather Purus	16.200,00	
D77005C051	Cat.ZC Pelle Churchill Cat.ZC Leather Churchill	17.500,00	

WOW by Philippe Starck, 2016

Modello Model	Codice Code	Categoria materiale - Descrizione materiale Material category - Material description	Prezzo Retail con Iva Retail price with Vat
Divano 3 posti A1 L. 259 P. 110,6 H. 98 Three-seater sofa A1 W. 259 D. 110,6 H. 98	D77006C700	Cat.A Cotone Bonifacio Cat.A Cotton Bonifacio	8.350,00
	D77006C701	Cat.A Poliestere Marsiglia Cat.A Polyester Marsiglia	
	D77006C702	Cat.A misto Poliestere, Acrilico, Cotone Petra Cat.A mixed Polyester, Acrylic, Cotton Petra	
	D77006C703	Cat.A misto Poliestere, Acrilico, Cotone Damasco Cat.A mixed Polyester, Acrylic, Cotton Damasco	
	D77006C704	Cat.B misto Poliestere, Acrilico, Cotone Berlino Cat.B mixed Polyester, Acrylic, Cotton Berlino	9.100,00
	D77006C705	Cat.B Poliestere Jakarta Cat.B Polyester Jakarta	
	D77006C706	Cat.B Poliestere Ginevra Cat.B Polyester Ginevra	
	D77006C032	Cat.C Velluto di cotone Loira Cat.C Cotton Velvet Loira	9.400,00
	D77006C036	Cat.C Misto Lino Lisbona Cat.C Linen Mix Lisbona	
	D77006C040	Cat.C Lino Barcellona Cat.C Linen Barcellona	
D77006C709	Cat.C Polipropilene Amburgo Cat.C Polypropylene Amburgo		
D77006C710	Cat.C misto Poliestere, Acrilico, Cotone, Lana, Viscosa Berna Cat.C mixed Polyester, Acrylic, Cotton, Wool, Viscose Berna		
D77006C712	Cat.D Lana vergine, Cotone, Poliammide Malmö Cat.D virgin Wool, Cotton, Polyamide Malmö	10.200,00	
D77006C713	Cat.E Lana Divina Melange Kvadrat Cat.E Wool Divina Melange Kvadrat	13.800,00	
D77006C714	Cat.E Cotone Venezia Cat.E Cotton Venezia		
D77006C050	Cat.P Pelle Niagara Cat.P Leather Niagara	12.400,00	
D77006C049	Cat.O Pelle Rio Cat.O Leather Rio	14.600,00	
D77006C052	Cat.ZME Pelle Amur Cat.ZME Leather Amur	16.600,00	
D77006C054	Cat.ZA Pelle Purus Cat.ZA Leather Purus	17.600,00	
D77006C051	Cat.ZC Pelle Churchill Cat.ZC Leather Churchill	19.300,00	

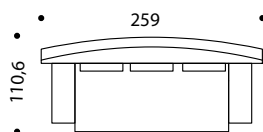

PER LA SCELTA DEI TESSUTI E PELLI CONSULTARE IL LIBRO "ABBINAMENTO TESSUTI-PELLI/MATERIALI"

FOR THE CHOICE OF FABRICS AND LEATHERS, SEE BOOK "MATCHING FABRICS-LEATHERS/MATERIALS"

WOW by Philippe Starck, 2016

Modello Model	Codice Code	Categoria materiale - Descrizione materiale Material category - Material description	Prezzo Retail con Iva Retail price with Vat
Composizione H L. 399 P. 110,6 H. 98 Composition H W. 399 D. 110,6 H. 98	D77407N700	Cat.A Cotone Bonifacio <i>Cat.A Cotton Bonifacio</i>	13.500,00
	D77407N701	Cat.A Poliestere Marsiglia <i>Cat.A Polyester Marsiglia</i>	
	D77407N702	Cat.A misto Poliestere, Acrilico, Cotone Petra <i>Cat.A mixed Polyester, Acrylic, Cotton Petra</i>	
	D77407N703	Cat.A misto Poliestere, Acrilico, Cotone Damasco <i>Cat.A mixed Polyester, Acrylic, Cotton Damasco</i>	
	D77407N028	Cat.A Ecopelle Colorado <i>Cat.A Eco-leather Colorado</i>	
	D77407N704	Cat.B misto Poliestere, Acrilico, Cotone Berlino <i>Cat.B mixed Polyester, Acrylic, Cotton Berlino</i>	14.600,00
	D77407N705	Cat.B Poliestere Jakarta <i>Cat.B Polyester Jakarta</i>	
	D77407N706	Cat.B Poliestere Ginevra <i>Cat.B Polyester Ginevra</i>	
	D77407N032	Cat.C Velluto di cotone Loira <i>Cat.C Cotton Velvet Loira</i>	15.000,00
	D77407N036	Cat.C Misto Lino Lisbona <i>Cat.C Linen Mix Lisbona</i>	
D77407N040	Cat.C Lino Barcellona <i>Cat.C Linen Barcellona</i>		
D77407N709	Cat.C Polipropilene Amburgo <i>Cat.C Polypropylene Amburgo</i>		
D77407N710	Cat.C misto Poliestere, Acrilico, Cotone, Lana, Viscosa Berna <i>Cat.C mixed Polyester, Acrylic, Cotton, Wool, Viscose Berna</i>		
D77407N712	Cat.D Lana vergine, Cotone, Poliammide Malmö <i>Cat.D virgin Wool, Cotton, Polyamide Malmö</i>	16.100,00	
D77407N713	Cat.E Lana Divina Melange Kvadrat <i>Cat.E Wool Divina Melange Kvadrat</i>	20.900,00	
D77407N714	Cat.E Cotone Venezia <i>Cat.E Cotton Venezia</i>		
D77407N050	Cat.P Pelle Niagara <i>Cat.P Leather Niagara</i>	20.250,00	
D77407N049	Cat.O Pelle Rio <i>Cat.O Leather Rio</i>	22.800,00	
D77407N052	Cat.ZME Pelle Amur <i>Cat.ZME Leather Amur</i>	25.000,00	
D77407N054	Cat.ZA Pelle Purus <i>Cat.ZA Leather Purus</i>	26.800,00	
D77407N051	Cat.ZC Pelle Churchill <i>Cat.ZC Leather Churchill</i>	31.700,00	

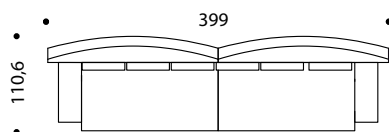

PER LA SCELTA DEI TESSUTI E PELLI CONSULTARE IL LIBRO "ABBINAMENTO TESSUTI-PELLI/MATERIALI"

FOR THE CHOICE OF FABRICS AND LEATHERS, SEE BOOK "MATCHING FABRICS-LEATHERS/MATERIALS"

WOW by Philippe Starck, 2016

Modello Model	Codice Code	Categoria materiale - Descrizione materiale Material category - Material description	Prezzo Retail con Iva Retail price with Vat
Dormeuse D1 L. 139,5 P. 190,6 H. 98 Daybed D1 W. 139,5 D. 190,6 H. 96	D77704M700	Cat.A Cotone Bonifacio <i>Cat.A Cotton Bonifacio</i>	6.700,00
	D77704M701	Cat.A Poliestere Marsiglia <i>Cat.A Polyester Marsiglia</i>	
	D77704M702	Cat.A misto Poliestere, Acrilico, Cotone Petra <i>Cat.A mixed Polyester, Acrylic, Cotton Petra</i>	
	D77704M703	Cat.A misto Poliestere, Acrilico, Cotone Damasco <i>Cat.A mixed Polyester, Acrylic, Cotton Damasco</i>	
	D77704M028	Cat.A Ecopelle Colorado <i>Cat.A Eco-leather Colorado</i>	
	D77704M704	Cat.B misto Poliestere, Acrilico, Cotone Berlino <i>Cat.B mixed Polyester, Acrylic, Cotton Berlino</i>	7.100,00
	D77704M705	Cat.B Poliestere Jakarta <i>Cat.B Polyester Jakarta</i>	
	D77704M706	Cat.B Poliestere Ginevra <i>Cat.B Polyester Ginevra</i>	
	D77704M032	Cat.C Velluto di cotone Loira <i>Cat.C Cotton Velvet Loira</i>	7.400,00
	D77704M036	Cat.C Misto Lino Lisbona <i>Cat.C Linen Mix Lisbona</i>	
	D77704M040	Cat.C Lino Barcellona <i>Cat.C Linen Barcellona</i>	
	D77704M709	Cat.C Polipropilene Amburgo <i>Cat.C Polypropylene Amburgo</i>	
D77704M710	Cat.C misto Poliestere, Acrilico, Cotone, Lana, Viscosa Berna <i>Cat.C mixed Polyester, Acrylic, Cotton, Wool, Viscose Berna</i>		
D77704M712	Cat.D Lana vergine, Cotone, Poliammide Malmö <i>Cat.D virgin Wool, Cotton, Polyamide Malmö</i>	8.000,00	
D77704M713	Cat.E Lana Divina Melange Kvadrat <i>Cat.E Wool Divina Melange Kvadrat</i>	9.800,00	
D77704M714	Cat.E Cotone Venezia <i>Cat.E Cotton Venezia</i>		
D77704M050	Cat.P Pelle Niagara <i>Cat.P Leather Niagara</i>	9.500,00	
D77704M049	Cat.O Pelle Rio <i>Cat.O Leather Rio</i>	10.700,00	
D77704M052	Cat.ZME Pelle Amur <i>Cat.ZME Leather Amur</i>	11.900,00	
D77704M054	Cat.ZA Pelle Purus <i>Cat.ZA Leather Purus</i>	12.550,00	
D77704M051	Cat.ZC Pelle Churchill <i>Cat.ZC Leather Churchill</i>	14.650,00	

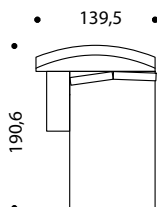

PER LA SCELTA DEI TESSUTI E PELLI CONSULTARE IL LIBRO "ABBINAMENTO TESSUTI-PELLI/MATERIALI"

FOR THE CHOICE OF FABRICS AND LEATHERS, SEE BOOK "MATCHING FABRICS-LEATHERS/MATERIALS"

WOW by Philippe Starck, 2016

Modello Model	Codice Code	Categoria materiale - Descrizione materiale Material category - Material description	Prezzo Retail con Iva Retail price with Vat
Dormeuse D2 L. 139,5 P. 190,6 H. 98 Daybed D2 W. 139,5 D. 190,6 H. 96	D77703M700	Cat.A Cotone Bonifacio <i>Cat.A Cotton Bonifacio</i>	6.700,00
	D77703M701	Cat.A Poliestere Marsiglia <i>Cat.A Polyester Marsiglia</i>	
	D77703M702	Cat.A misto Poliestere, Acrilico, Cotone Petra <i>Cat.A mixed Polyester, Acrylic, Cotton Petra</i>	
	D77703M703	Cat.A misto Poliestere, Acrilico, Cotone Damasco <i>Cat.A mixed Polyester, Acrylic, Cotton Damasco</i>	
	D77703M028	Cat.A Ecopelle Colorado <i>Cat.A Eco-leather Colorado</i>	
	D77703M704	Cat.B misto Poliestere, Acrilico, Cotone Berlino <i>Cat.B mixed Polyester, Acrylic, Cotton Berlino</i>	7.100,00
	D77703M705	Cat.B Poliestere Jakarta <i>Cat.B Polyester Jakarta</i>	
	D77703M706	Cat.B Poliestere Ginevra <i>Cat.B Polyester Ginevra</i>	
	D77703M032	Cat.C Velluto di cotone Loira <i>Cat.C Cotton Velvet Loira</i>	7.400,00
	D77703M036	Cat.C Misto Lino Lisbona <i>Cat.C Linen Mix Lisbona</i>	
	D77703M040	Cat.C Lino Barcellona <i>Cat.C Linen Barcellona</i>	
	D77703M709	Cat.C Polipropilene Amburgo <i>Cat.C Polypropylene Amburgo</i>	
D77703M710	Cat.C misto Poliestere, Acrilico, Cotone, Lana, Viscosa Berna <i>Cat.C mixed Polyester, Acrylic, Cotton, Wool, Viscose Berna</i>		
D77703M712	Cat.D Lana vergine, Cotone, Poliammide Malmö <i>Cat.D virgin Wool, Cotton, Polyamide Malmö</i>	8.000,00	
D77703M713	Cat.E Lana Divina Melange Kvadrat <i>Cat.E Wool Divina Melange Kvadrat</i>	9.800,00	
D77703M714	Cat.E Cotone Venezia <i>Cat.E Cotton Venezia</i>		
D77703M050	Cat.P Pelle Niagara <i>Cat.P Leather Niagara</i>	9.500,00	
D77703M049	Cat.O Pelle Rio <i>Cat.O Leather Rio</i>	10.700,00	
D77703M052	Cat.ZME Pelle Amur <i>Cat.ZME Leather Amur</i>	11.900,00	
D77703M054	Cat.ZA Pelle Purus <i>Cat.ZA Leather Purus</i>	12.550,00	
D77703M051	Cat.ZC Pelle Churchill <i>Cat.ZC Leather Churchill</i>	14.650,00	

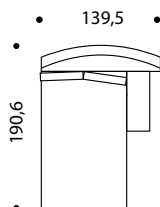

PER LA SCELTA DEI TESSUTI E PELLI CONSULTARE IL LIBRO "ABBINAMENTO TESSUTI-PELLI/MATERIALI"

FOR THE CHOICE OF FABRICS AND LEATHERS, SEE BOOK "MATCHING FABRICS-LEATHERS/MATERIALS"

WOW by Philippe Starck, 2016

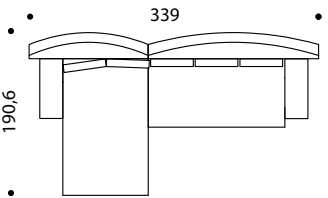
Modello Model	Codice Code	Categoria materiale - Descrizione materiale Material category - Material description	Prezzo Retail con Iva Retail price with Vat
<p>Composizione E1 L. 339 P. 190,6 H. 98</p> <p>Composition E1 W. 339 D. 190,6 H. 98</p>  <p>PER LA SCELTA DEI TESSUTI E PELLI CONSULTARE IL LIBRO "ABBINAMENTO TESSUTI-PELLI/MATERIALI"</p> <p>FOR THE CHOICE OF FABRICS AND LEATHERS, SEE BOOK "MATCHING FABRICS-LEATHERS/MATERIALS"</p>	D79003F700	Cat.A Cotone Bonifacio <i>Cat.A Cotton Bonifacio</i>	13.400,00
	D79003F701	Cat.A Poliestere Marsiglia <i>Cat.A Polyester Marsiglia</i>	
	D79003F702	Cat.A misto Poliestere, Acrilico, Cotone Petra <i>Cat.A mixed Polyester, Acrylic, Cotton Petra</i>	
	D79003F703	Cat.A misto Poliestere, Acrilico, Cotone Damasco <i>Cat.A mixed Polyester, Acrylic, Cotton Damasco</i>	
	D79003F028	Cat.A Ecopelle Colorado <i>Cat.A Eco-leather Colorado</i>	
	D79003F704	Cat.B misto Poliestere, Acrilico, Cotone Berlino <i>Cat.B mixed Polyester, Acrylic, Cotton Berlino</i>	14.350,00
	D79003F705	Cat.B Poliestere Jakarta <i>Cat.B Polyester Jakarta</i>	
	D79003F706	Cat.B Poliestere Ginevra <i>Cat.B Polyester Ginevra</i>	
	D79003F032	Cat.C Velluto di cotone Loira <i>Cat.C Cotton Velvet Loira</i>	14.850,00
	D79003F036	Cat.C Misto Lino Lisbona <i>Cat.C Linen Mix Lisbona</i>	
	D79003F040	Cat.C Lino Barcellona <i>Cat.C Linen Barcellona</i>	
	D79003F709	Cat.C Polipropilene Amburgo <i>Cat.C Polypropylene Amburgo</i>	
	D79003F710	Cat.C misto Poliestere, Acrilico, Cotone, Lana, Viscosa Berna <i>Cat.C mixed Polyester, Acrylic, Cotton, Wool, Viscose Berna</i>	
	D79003F712	Cat.D Lana vergine, Cotone, Poliammide Malmö <i>Cat.D virgin Wool, Cotton, Polyamide Malmö</i>	16.150,00
	D79003F713	Cat.E Lana Divina Melange Kvadrat <i>Cat.E Wool Divina Melange Kvadrat</i>	20.900,00
	D79003F714	Cat.E Cotone Venezia <i>Cat.E Cotton Venezia</i>	
	D79003F050	Cat.P Pelle Niagara <i>Cat.P Leather Niagara</i>	20.350,00
	D79003F049	Cat.O Pelle Rio <i>Cat.O Leather Rio</i>	23.100,00
	D79003F052	Cat.ZME Pelle Amur <i>Cat.ZME Leather Amur</i>	26.050,00
D79003F054	Cat.ZA Pelle Purus <i>Cat.ZA Leather Purus</i>	27.650,00	
D79003F051	Cat.ZC Pelle Churchill <i>Cat.ZC Leather Churchill</i>	31.850,00	

WOW by Philippe Starck, 2016

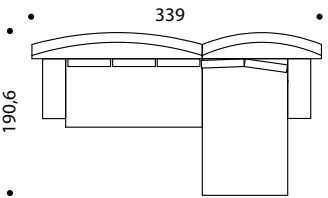
Modello Model	Codice Code	Categoria materiale - Descrizione materiale Material category - Material description	Prezzo Retail con Iva Retail price with Vat
Composizione E2 L. 339 P. 190,6 H. 98	D79002F700	Cat.A Cotone Bonifacio <i>Cat.A Cotton Bonifacio</i>	13.400,00
	D79002F701	Cat.A Poliestere Marsiglia <i>Cat.A Polyester Marsiglia</i>	
Composition E2 W. 339 D. 190,6 H. 98	D79002F702	Cat.A misto Poliestere, Acrilico, Cotone Petra <i>Cat.A mixed Polyester, Acrylic, Cotton Petra</i>	14.350,00
	D79002F703	Cat.A misto Poliestere, Acrilico, Cotone Damasco <i>Cat.A mixed Polyester, Acrylic, Cotton Damasco</i>	
	D79002F028	Cat.A Ecopelle Colorado <i>Cat.A Eco-leather Colorado</i>	14.850,00
	D79002F704	Cat.B misto Poliestere, Acrilico, Cotone Berlino <i>Cat.B mixed Polyester, Acrylic, Cotton Berlino</i>	
	D79002F705	Cat.B Poliestere Jakarta <i>Cat.B Polyester Jakarta</i>	
	D79002F706	Cat.B Poliestere Ginevra <i>Cat.B Polyester Ginevra</i>	
	D79002F032	Cat.C Velluto di cotone Loira <i>Cat.C Cotton Velvet Loira</i>	
	D79002F036	Cat.C Misto Lino Lisbona <i>Cat.C Linen Mix Lisbona</i>	
<p>PER LA SCELTA DEI TESSUTI E PELLI CONSULTARE IL LIBRO "ABBINAMENTO TESSUTI-PELLI/MATERIALI"</p> <p>FOR THE CHOICE OF FABRICS AND LEATHERS, SEE BOOK "MATCHING FABRICS-LEATHERS/MATERIALS"</p>	D79002F040	Cat.C Lino Barcellona <i>Cat.C Linen Barcellona</i>	16.150,00
	D79002F709	Cat.C Polipropilene Amburgo <i>Cat.C Polypropylene Amburgo</i>	
	D79002F710	Cat.C misto Poliestere, Acrilico, Cotone, Lana, Viscosa Berna <i>Cat.C mixed Polyester, Acrylic, Cotton, Wool, Viscose Berna</i>	
	D79002F712	Cat.D Lana vergine, Cotone, Poliammide Malmö <i>Cat.D virgin Wool, Cotton, Polyamide Malmö</i>	
	D79002F713	Cat.E Lana Divina Melange Kvadrat <i>Cat.E Wool Divina Melange Kvadrat</i>	
<p>PER LA SCELTA DEI TESSUTI E PELLI CONSULTARE IL LIBRO "ABBINAMENTO TESSUTI-PELLI/MATERIALI"</p> <p>FOR THE CHOICE OF FABRICS AND LEATHERS, SEE BOOK "MATCHING FABRICS-LEATHERS/MATERIALS"</p>	D79002F714	Cat.E Cotone Venezia <i>Cat.E Cotton Venezia</i>	20.900,00
	D79002F050	Cat.P Pelle Niagara <i>Cat.P Leather Niagara</i>	
	D79002F049	Cat.O Pelle Rio <i>Cat.O Leather Rio</i>	
	D79002F052	Cat.ZME Pelle Amur <i>Cat.ZME Leather Amur</i>	
	D79002F054	Cat.ZA Pelle Purus <i>Cat.ZA Leather Purus</i>	
	D79002F051	Cat.ZC Pelle Churchill <i>Cat.ZC Leather Churchill</i>	

WOW by Philippe Starck, 2016

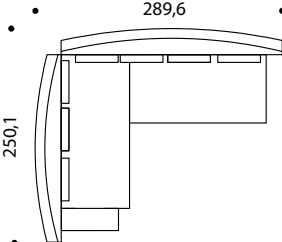
Modello Model	Codice Code	Categoria materiale - Descrizione materiale Material category - Material description	Prezzo Retail con Iva Retail price with Vat
Composizione M1 L. 289,6 P. 251,1 H. 98 Composition M1 W. 289,6 D. 251,1 H. 98 	D79503F700	Cat.A Cotone Bonifacio <i>Cat.A Cotton Bonifacio</i>	13.900,00
	D79503F701	Cat.A Poliestere Marsiglia <i>Cat.A Polyester Marsiglia</i>	
	D79503F702	Cat.A misto Poliestere, Acrilico, Cotone Petra <i>Cat.A mixed Polyester, Acrylic, Cotton Petra</i>	
	D79503F703	Cat.A misto Poliestere, Acrilico, Cotone Damasco <i>Cat.A mixed Polyester, Acrylic, Cotton Damasco</i>	
	D79503F028	Cat.A Ecopelle Colorado <i>Cat.A Eco-leather Colorado</i>	
	D79503F704	Cat.B misto Poliestere, Acrilico, Cotone Berlino <i>Cat.B mixed Polyester, Acrylic, Cotton Berlino</i>	14.900,00
	D79503F705	Cat.B Poliestere Jakarta <i>Cat.B Polyester Jakarta</i>	
	D79503F706	Cat.B Poliestere Ginevra <i>Cat.B Polyester Ginevra</i>	
	D79503F032	Cat.C Velluto di cotone Loira <i>Cat.C Cotton Velvet Loira</i>	15.600,00
	D79503F036	Cat.C Misto Lino Lisbona <i>Cat.C Linen Mix Lisbona</i>	
	D79503F040	Cat.C Lino Barcellona <i>Cat.C Linen Barcellona</i>	
	D79503F709	Cat.C Polipropilene Amburgo <i>Cat.C Polypropylene Amburgo</i>	
	D79503F710	Cat.C misto Poliestere, Acrilico, Cotone, Lana, Viscosa Berna <i>Cat.C mixed Polyester, Acrylic, Cotton, Wool, Viscose Berna</i>	
	D79503F712	Cat.D Lana vergine, Cotone, Poliammide Malmö <i>Cat.D virgin Wool, Cotton, Polyamide Malmö</i>	16.700,00
	D79503F713	Cat.E Lana Divina Melange Kvadrat <i>Cat.E Wool Divina Melange Kvadrat</i>	21.800,00
	D79503F714	Cat.E Cotone Venezia <i>Cat.E Cotton Venezia</i>	
	D79503F050	Cat.P Pelle Niagara <i>Cat.P Leather Niagara</i>	21.500,00
	D79503F049	Cat.O Pelle Rio <i>Cat.O Leather Rio</i>	25.200,00
	D79503F052	Cat.ZME Pelle Amur <i>Cat.ZME Leather Amur</i>	28.900,00
	D79503F054	Cat.ZA Pelle Purus <i>Cat.ZA Leather Purus</i>	31.400,00
D79503F051	Cat.ZC Pelle Churchill <i>Cat.ZC Leather Churchill</i>	37.500,00	

PER LA SCELTA DEI TESSUTI E PELLI CONSULTARE IL LIBRO "ABBINAMENTO TESSUTI-PELLI/MATERIALI"

FOR THE CHOICE OF FABRICS AND LEATHERS, SEE BOOK "MATCHING FABRICS-LEATHERS/MATERIALS"

WOW by Philippe Starck, 2016

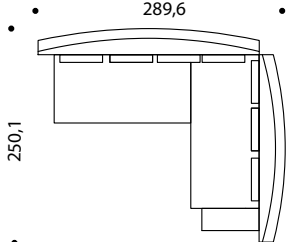
Modello Model	Codice Code	Categoria materiale - Descrizione materiale Material category - Material description	Prezzo Retail con Iva Retail price with Vat
Composizione M2 L. 289,6 P. 251,1 H. 98 Composition M2 W. 289,6 D. 251,1 H. 98 	D79502F700	Cat.A Cotone Bonifacio Cat.A Cotton Bonifacio	13.900,00
	D79502F701	Cat.A Poliestere Marsiglia Cat.A Polyester Marsiglia	
	D79502F702	Cat.A misto Poliestere, Acrilico, Cotone Petra Cat.A mixed Polyester, Acrylic, Cotton Petra	
	D79502F703	Cat.A misto Poliestere, Acrilico, Cotone Damasco Cat.A mixed Polyester, Acrylic, Cotton Damasco	
	D79502F028	Cat.A Ecopelle Colorado Cat.A Eco-leather Colorado	
	D79502F704	Cat.B misto Poliestere, Acrilico, Cotone Berlino Cat.B mixed Polyester, Acrylic, Cotton Berlino	14.900,00
	D79502F705	Cat.B Poliestere Jakarta Cat.B Polyester Jakarta	
	D79502F706	Cat.B Poliestere Ginevra Cat.B Polyester Ginevra	
	D79502F032	Cat.C Velluto di cotone Loira Cat.C Cotton Velvet Loira	15.600,00
	D79502F036	Cat.C Misto Lino Lisbona Cat.C Linen Mix Lisbona	
	D79502F040	Cat.C Lino Barcellona Cat.C Linen Barcellona	
	D79502F709	Cat.C Polipropilene Amburgo Cat.C Polypropylene Amburgo	
	D79502F710	Cat.C misto Poliestere, Acrilico, Cotone, Lana, Viscosa Berna Cat.C mixed Polyester, Acrylic, Cotton, Wool, Viscose Berna	
	D79502F712	Cat.D Lana vergine, Cotone, Poliammide Malmö Cat.D virgin Wool, Cotton, Polyamide Malmö	16.700,00
	D79502F713	Cat.E Lana Divina Melange Kvadrat Cat.E Wool Divina Melange Kvadrat	21.800,00
	D79502F714	Cat.E Cotone Venezia Cat.E Cotton Venezia	
	D79502F050	Cat.P Pelle Niagara Cat.P Leather Niagara	21.500,00
	D79502F049	Cat.O Pelle Rio Cat.O Leather Rio	25.200,00
	D79502F052	Cat.ZME Pelle Amur Cat.ZME Leather Amur	28.900,00
	D79502F054	Cat.ZA Pelle Purus Cat.ZA Leather Purus	31.400,00
D79502F051	Cat.ZC Pelle Churchill Cat.ZC Leather Churchill	37.500,00	

PER LA SCELTA DEI TESSUTI E PELLI CONSULTARE IL LIBRO "ABBINAMENTO TESSUTI-PELLI/MATERIALI"

FOR THE CHOICE OF FABRICS AND LEATHERS, SEE BOOK "MATCHING FABRICS-LEATHERS/MATERIALS"

WOW by Philippe Starck, 2016

Modello Model	Codice Code	Categoria materiale - Descrizione materiale Material category - Material description	Prezzo Retail con Iva Retail price with Vat
Composizione S1 L. 300 P. 340 H. 98 Composition S1 W. 300 D. 340 H. 98	D79383F700	Cat.A Cotone Bonifacio <i>Cat.A Cotton Bonifacio</i>	14.850,00
	D79383F701	Cat.A Poliestere Marsiglia <i>Cat.A Polyester Marsiglia</i>	
	D79383F702	Cat.A misto Poliestere, Acrilico, Cotone Petra <i>Cat.A mixed Polyester, Acrylic, Cotton Petra</i>	
	D79383F703	Cat.A misto Poliestere, Acrilico, Cotone Damasco <i>Cat.A mixed Polyester, Acrylic, Cotton Damasco</i>	
	D79383F028	Cat.A Ecopelle Colorado <i>Cat.A Eco-leather Colorado</i>	
	D79383F704	Cat.B misto Poliestere, Acrilico, Cotone Berlino <i>Cat.B mixed Polyester, Acrylic, Cotton Berlino</i>	16.350,00
	D79383F705	Cat.B Poliestere Jakarta <i>Cat.B Polyester Jakarta</i>	
	D79383F706	Cat.B Poliestere Ginevra <i>Cat.B Polyester Ginevra</i>	
	D79383F032	Cat.C Velluto di cotone Loira <i>Cat.C Cotton Velvet Loira</i>	16.700,00
	D79383F036	Cat.C Misto Lino Lisbona <i>Cat.C Linen Mix Lisbona</i>	
D79383F040	Cat.C Lino Barcellona <i>Cat.C Linen Barcellona</i>		
D79383F709	Cat.C Polipropilene Amburgo <i>Cat.C Polypropylene Amburgo</i>		
D79383F710	Cat.C misto Poliestere, Acrilico, Cotone, Lana, Viscosa Berna <i>Cat.C mixed Polyester, Acrylic, Cotton, Wool, Viscose Berna</i>		
D79383F712	Cat.D Lana vergine, Cotone, Poliammide Malmö <i>Cat.D virgin Wool, Cotton, Polyamide Malmö</i>	17.950,00	
D79383F713	Cat.E Lana Divina Melange Kvadrat <i>Cat.E Wool Divina Melange Kvadrat</i>	24.000,00	
D79383F714	Cat.E Cotone Venezia <i>Cat.E Cotton Venezia</i>		
D79383F050	Cat.P Pelle Niagara <i>Cat.P Leather Niagara</i>	22.950,00	
D79383F049	Cat.O Pelle Rio <i>Cat.O Leather Rio</i>	27.300,00	
D79383F052	Cat.ZME Pelle Amur <i>Cat.ZME Leather Amur</i>	30.400,00	
D79383F054	Cat.ZA Pelle Purus <i>Cat.ZA Leather Purus</i>	32.800,00	
D79383F051	Cat.ZC Pelle Churchill <i>Cat.ZC Leather Churchill</i>	35.300,00	

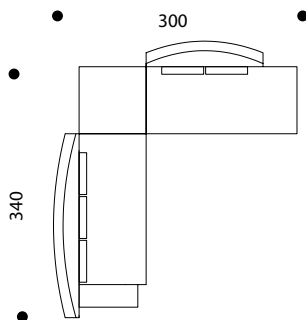

PER LA SCELTA DEI TESSUTI E PELLI CONSULTARE IL LIBRO "ABBINAMENTO TESSUTI-PELLI/MATERIALI"

FOR THE CHOICE OF FABRICS AND LEATHERS, SEE BOOK "MATCHING FABRICS-LEATHERS/MATERIALS"

WOW by Philippe Starck, 2016

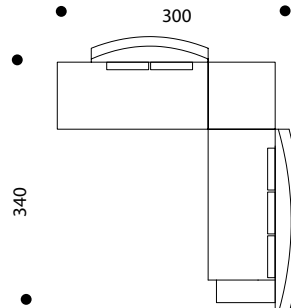
Modello Model	Codice Code	Categoria materiale - Descrizione materiale Material category - Material description	Prezzo Retail con Iva Retail price with Vat
<p>Composizione S2 L. 300 P. 340 H. 98</p> <p>Composition S2 W. 300 D. 340 H. 98</p>  <p>PER LA SCELTA DEI TESSUTI E PELLI CONSULTARE IL LIBRO "ABBINAMENTO TESSUTI-PELLI/MATERIALI"</p> <p>FOR THE CHOICE OF FABRICS AND LEATHERS, SEE BOOK "MATCHING FABRICS-LEATHERS/MATERIALS"</p>	D79382F700	Cat.A Cotone Bonifacio Cat.A Cotton Bonifacio	14.850,00
	D79382F701	Cat.A Poliestere Marsiglia Cat.A Polyester Marsiglia	
	D79382F702	Cat.A misto Poliestere, Acrilico, Cotone Petra Cat.A mixed Polyester, Acrylic, Cotton Petra	
	D79382F703	Cat.A misto Poliestere, Acrilico, Cotone Damasco Cat.A mixed Polyester, Acrylic, Cotton Damasco	
	D79382F028	Cat.A Ecopelle Colorado Cat.A Eco-leather Colorado	
	D79382F704	Cat.B misto Poliestere, Acrilico, Cotone Berlino Cat.B mixed Polyester, Acrylic, Cotton Berlino	16.350,00
	D79382F705	Cat.B Poliestere Jakarta Cat.B Polyester Jakarta	
	D79382F706	Cat.B Poliestere Ginevra Cat.B Polyester Ginevra	
	D79382F032	Cat.C Velluto di cotone Loira Cat.C Cotton Velvet Loira	16.700,00
	D79382F036	Cat.C Misto Lino Lisbona Cat.C Linen Mix Lisbona	
	D79382F040	Cat.C Lino Barcellona Cat.C Linen Barcellona	
	D79382F709	Cat.C Polipropilene Amburgo Cat.C Polypropylene Amburgo	
	D79382F710	Cat.C misto Poliestere, Acrilico, Cotone, Lana, Viscosa Berna Cat.C mixed Polyester, Acrylic, Cotton, Wool, Viscose Berna	
	D79382F712	Cat.D Lana vergine, Cotone, Poliammide Malmö Cat.D virgin Wool, Cotton, Polyamide Malmö	17.950,00
	D79382F713	Cat.E Lana Divina Melange Kvadrat Cat.E Wool Divina Melange Kvadrat	24.000,00
	D79382F714	Cat.E Cotone Venezia Cat.E Cotton Venezia	
	D79382F050	Cat.P Pelle Niagara Cat.P Leather Niagara	22.950,00
	D79382F049	Cat.O Pelle Rio Cat.O Leather Rio	27.300,00
	D79382F052	Cat.ZME Pelle Amur Cat.ZME Leather Amur	30.400,00
D79382F054	Cat.ZA Pelle Purus Cat.ZA Leather Purus	32.800,00	
D79382F051	Cat.ZC Pelle Churchill Cat.ZC Leather Churchill	35.300,00	

WOW by Philippe Starck, 2016

Modello Model	Codice Code	Categoria materiale - Descrizione materiale Material category - Material description	Prezzo Retail con Iva Retail price with Vat
Pouf L. 80 P. 80 H. 40 Ottoman W. 80 D. 80 H. 40	D79900C700	Cat.A Cotone Bonifacio <i>Cat.A Cotton Bonifacio</i>	2.250,00
	D79900C701	Cat.A Poliestere Marsiglia <i>Cat.A Polyester Marsiglia</i>	
	D79900C702	Cat.A misto Poliestere, Acrilico, Cotone Petra <i>Cat.A mixed Polyester, Acrylic, Cotton Petra</i>	
	D79900C703	Cat.A misto Poliestere, Acrilico, Cotone Damasco <i>Cat.A mixed Polyester, Acrylic, Cotton Damasco</i>	
	D79900C028	Cat.A Ecopelle Colorado <i>Cat.A Eco-leather Colorado</i>	
	D79900C704	Cat.B misto Poliestere, Acrilico, Cotone Berlino <i>Cat.B mixed Polyester, Acrylic, Cotton Berlino</i>	2.500,00
	D79900C705	Cat.B Poliestere Jakarta <i>Cat.B Polyester Jakarta</i>	
	D79900C706	Cat.B Poliestere Ginevra <i>Cat.B Polyester Ginevra</i>	
PER LA SCELTA DEI TESSUTI E PELLI CONSULTARE IL LIBRO "ABBINAMENTO TESSUTI-PELLI/MATERIALI" FOR THE CHOICE OF FABRICS AND LEATHERS, SEE BOOK "MATCHING FABRICS-LEATHERS/MATERIALS"	D79900C032	Cat.C Velluto di cotone Loira <i>Cat.C Cotton Velvet Loira</i>	2.600,00
	D79900C036	Cat.C Misto Lino Lisbona <i>Cat.C Linen Mix Lisbona</i>	
	D79900C040	Cat.C Lino Barcellona <i>Cat.C Linen Barcellona</i>	
	D79900C709	Cat.C Polipropilene Amburgo <i>Cat.C Polypropylene Amburgo</i>	
	D79900C710	Cat.C misto Poliestere, Acrilico, Cotone, Lana, Viscosa Berna <i>Cat.C mixed Polyester, Acrylic, Cotton, Wool, Viscose Berna</i>	
D79900C712	Cat.D Lana vergine, Cotone, Poliammide Malmö <i>Cat.D virgin Wool, Cotton, Polyamide Malmö</i>	2.800,00	
D79900C713	Cat.E Lana Divina Melange Kvadrat <i>Cat.E Wool Divina Melange Kvadrat</i>	3.900,00	
D79900C714	Cat.E Cotone Venezia <i>Cat.E Cotton Venezia</i>		
D79900C050	Cat.P Pelle Niagara <i>Cat.P Leather Niagara</i>	3.800,00	
D79900C049	Cat.O Pelle Rio <i>Cat.O Leather Rio</i>	4.300,00	
D79900C052	Cat.ZME Pelle Amur <i>Cat.ZME Leather Amur</i>	5.100,00	
D79900C054	Cat.ZA Pelle Purus <i>Cat.ZA Leather Purus</i>	5.400,00	
D79900C051	Cat.ZC Pelle Churchill <i>Cat.ZC Leather Churchill</i>	5.700,00	

TABELLA PESI E VOLUMI COMPOSIZIONI WOW
LIST OF WEIGHTS AND VOLUMES COMPOSITIONS WOW



WOW Divano a due posti A2

COLLI: NR. 2; PESO: 40 + 63 Kg.; VOLUME: 1,023 + 1,148 mc

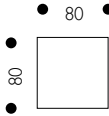
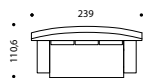
WOW Two-seater sofa A2

BOXES: NO. 2; WEIGHT: 40 + 63 Kg.; VOLUME: 1,023 + 1,148 cbm

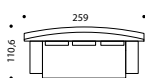

WOW Divano a tre posti A1

COLLI: NR. 2; PESO: 43 + 74 Kg.; VOLUME: 1,023 + 1,236 mc

WOW Three-seater sofa A1

BOXES: NO. 2; WEIGHT: 43 + 74 Kg.; VOLUME: 1,023 + 1,236 cbm

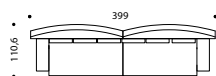

WOW Composizione H

COLLI: NR. 4; PESO: 34 + 34 + 56 + 56 Kg.; VOLUME: 0,865 + 0,865 + 0,983 + 0,983 mc

WOW Composition H

BOXES: NO. 4; WEIGHT: 34 + 34 + 56 + 56 Kg.; VOLUME: 0,865 + 0,865 + 0,983 + 0,983 cbm

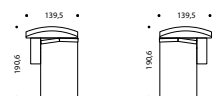

WOW Composizione D1- D2

COLLI: NR. 2; PESO: 25 + 67 Kg.; VOLUME: 0,557 + 1,324 mc

WOW Composition D1- D2

BOXES: NO. 2; WEIGHT: 25 + 67 Kg.; VOLUME: 0,557 + 1,324 cbm

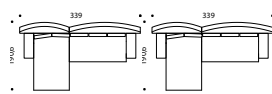

WOW Composizione E1- E2

COLLI: NR. 4; PESO: 25 + 34 + 67 + 56 Kg.; VOLUME: 0,557 + 0,865 + 1,324 + 0,983 mc

WOW Composition E1- E2

BOXES: NO. 4; WEIGHT: 25 + 34 + 67 + 56 Kg.; VOLUME: 0,557 + 0,865 + 1,324 + 0,983 cbm

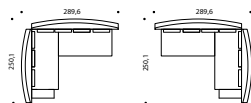

WOW Composizione M1- M2

COLLI: NR. 4; PESO: 37 + 43 + 63 + 56 Kg.; VOLUME: 0,865 + 1,023 + 1,148 + 0,983 mc

WOW Composition M1- M2

BOXES: NO. 4; WEIGHT: 37 + 43 + 63 + 56 Kg.; VOLUME: 0,865 + 1,023 + 1,148 + 0,983 cbm

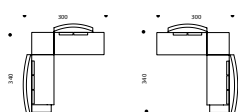

WOW Composizione S1- S2

COLLI: NR. 5; PESO: 25 + 37 + 63 + 39 + 56 Kg.; VOLUME: 0,557 + 0,865 + 1,148 + 0,580 + 0,983 mc

WOW Composition S1- S2

BOXES: NO. 5; WEIGHT: 25 + 37 + 63 + 39 + 56 Kg.; VOLUME: 0,557 + 0,865 + 1,148 + 0,580 + 0,983 cbm

CUSCINI DECORATIVI/THROW CUSHIONS by Driade Lab

Modello Model	Codice Code	Categoria materiale - Descrizione materiale Material category - Material description	Prezzo Retail con Iva Retail price with Vat
<p>Cuscini in piuma (parte interna) e tela d'uovo (parte esterna). Rivestimento sfoderabile in tessuto, fisso in pell . Uso solo interno. L. 40 H. 40; P.L. 1 Kg; V. 0,10 mc</p> <p><i>Inner part of the cushions in goose down and outer part in eggskin. Removable cover in fabric, fixed in leather. Indoor use only. W. 40 H. 40; G.W. 1 Kg; V. 0,10 cbm</i></p>	D42751G700	Cat.A Cotone Bonifacio <i>Cat.A Cotton Bonifacio</i>	125,00
	D42751G701	Cat.A Poliestere Marsiglia <i>Cat.A Polyester Marsiglia</i>	
	D42751G702	Cat.A misto Poliestere, Acrilico, Cotone Petra <i>Cat.A mixed Polyester, Acrylic, Cotton Petra</i>	
	D42751G703	Cat.A misto Poliestere, Acrilico, Cotone Damasco <i>Cat.A mixed Polyester, Acrylic, Cotton Damasco</i>	
	D42751G028	Cat.A Ecopelle Colorado <i>Cat.A Eco-leather Colorado</i>	
	D42751G704	Cat.B misto Poliestere, Acrilico, Cotone Berlino <i>Cat.B mixed Polyester, Acrylic, Cotton Berlino</i>	145,00
	D42751G705	Cat.B Poliestere Jakarta <i>Cat.B Polyester Jakarta</i>	
	D42751G706	Cat.B Poliestere Ginevra <i>Cat.B Polyester Ginevra</i>	
	D42751G032	Cat.C Velluto di cotone Loira <i>Cat.C Cotton Velvet Loira</i>	160,00
	D42751G036	Cat.C Misto Lino Lisbona <i>Cat.C Linen Mix Lisbona</i>	
D42751G040	Cat.C Lino Barcellona <i>Cat.C Linen Barcellona</i>		
D42751G709	Cat.C Polipropilene Amburgo <i>Cat.C Polypropylene Amburgo</i>		
D42751G710	Cat.C misto Poliestere, Acrilico, Cotone, Lana, Viscosa Berna <i>Cat.C mixed Polyester, Acrylic, Cotton, Wool, Viscose Berna</i>		
D42751G719	Cat.C Poliestere Mosca <i>Cat.C Polyester Mosca</i>		
D42751G712	Cat.D Lana vergine, Cotone, Poliammide Malmö <i>Cat.D virgin Wool, Cotton, Polyamide Malmö</i>	180,00	
D42751G713	Cat.E Lana Divina Melange Kvadrat <i>Cat.E Wool Divina Melange Kvadrat</i>	230,00	
D42751G714	Cat.E Cotone Venezia <i>Cat.E Cotton Venezia</i>		
D42751G717	Cat.E Modacrilica, Poliestere Pechino <i>Cat.E Modacrylic, Polyester Pechino</i>		
D42751G718	Cat.E Modacrilica, Poliestere Mongolia <i>Cat.E Modacrylic, Polyester Mongolia</i>		
D42751G050	Cat.P Pelle Niagara <i>Cat.P Leather Niagara</i>	215,00	
D42751G049	Cat.O Pelle Rio <i>Cat.O Leather Rio</i>	250,00	
D42751G052	Cat.ZME Pelle Amur <i>Cat.ZME Leather Amur</i>	285,00	
D42751G054	Cat.ZA Pelle Purus <i>Cat.ZA Leather Purus</i>	295,00	
D42751G053	Cat.ZS Pelle Sacramento <i>Cat.ZS Leather Sacramento</i>	315,00	
D42751G051	Cat.ZC Pelle Churchill <i>Cat.ZC Leather Churchill</i>	360,00	

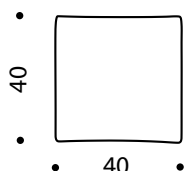

PER LA SCELTA DEI TESSUTI E PELLI CONSULTARE IL LIBRO "ABBINAMENTO TESSUTI-PELLI/MATERIALI"

FOR THE CHOICE OF FABRICS AND LEATHERS, SEE BOOK "MATCHING FABRICS-LEATHERS/MATERIALS"

CUSCINI DECORATIVI/THROW CUSHIONS by Driade Lab

Modello Model	Codice Code	Categoria materiale - Descrizione materiale Material category - Material description	Prezzo Retail con Iva Retail price with Vat
<p>Cuscini in piuma (parte interna) e tela d'uovo (parte esterna). Rivestimento sfoderabile in tessuto, fisso in pell . Uso solo interno. L. 50 H. 27; P.L. 0,70 Kg; V. 0,10 mc</p> <p><i>Inner part of the cushions in goose down and outer part in eggskin. Removable cover in fabric, fixed in leather. Indoor use only. W. 50 H. 27; G.W. 0,70 Kg; V. 0,10 cbm</i></p>	D42762G700	Cat.A Cotone Bonifacio <i>Cat.A Cotton Bonifacio</i>	110,00
	D42762G701	Cat.A Poliestere Marsiglia <i>Cat.A Polyester Marsiglia</i>	
	D42762G702	Cat.A misto Poliestere, Acrilico, Cotone Petra <i>Cat.A mixed Polyester, Acrylic, Cotton Petra</i>	
	D42762G703	Cat.A misto Poliestere, Acrilico, Cotone Damasco <i>Cat.A mixed Polyester, Acrylic, Cotton Damasco</i>	
	D42762G028	Cat.A Ecopelle Colorado <i>Cat.A Eco-leather Colorado</i>	
	D42762G704	Cat.B misto Poliestere, Acrilico, Cotone Berlino <i>Cat.B mixed Polyester, Acrylic, Cotton Berlino</i>	135,00
	D42762G705	Cat.B Poliestere Jakarta <i>Cat.B Polyester Jakarta</i>	
	D42762G706	Cat.B Poliestere Ginevra <i>Cat.B Polyester Ginevra</i>	
	D42762G032	Cat.C Velluto di cotone Loira <i>Cat.C Cotton Velvet Loira</i>	145,00
	D42762G036	Cat.C Misto Lino Lisbona <i>Cat.C Linen Mix Lisbona</i>	
D42762G040	Cat.C Lino Barcellona <i>Cat.C Linen Barcellona</i>		
D42762G709	Cat.C Polipropilene Amburgo <i>Cat.C Polypropylene Amburgo</i>		
D42762G710	Cat.C misto Poliestere, Acrilico, Cotone, Lana, Viscosa Berna <i>Cat.C mixed Polyester, Acrylic, Cotton, Wool, Viscose Berna</i>		
D42762G719	Cat.C Poliestere Mosca <i>Cat.C Polyester Mosca</i>		
D42762G712	Cat.D Lana vergine, Cotone, Poliammide Malmö <i>Cat.D virgin Wool, Cotton, Polyamide Malmö</i>	160,00	
D42762G713	Cat.E Lana Divina Melange Kvadrat <i>Cat.E Wool Divina Melange Kvadrat</i>	205,00	
D42762G714	Cat.E Cotone Venezia <i>Cat.E Cotton Venezia</i>		
D42762G717	Cat.E Modacrilica, Poliestere Pechino <i>Cat.E Modacrylic, Polyester Pechino</i>		
D42762G718	Cat.E Modacrilica, Poliestere Mongolia <i>Cat.E Modacrylic, Polyester Mongolia</i>		
D42762G050	Cat.P Pelle Niagara <i>Cat.P Leather Niagara</i>	190,00	
D42762G049	Cat.O Pelle Rio <i>Cat.O Leather Rio</i>	215,00	
D42762G052	Cat.ZME Pelle Amur <i>Cat.ZME Leather Amur</i>	245,00	
D42762G054	Cat.ZA Pelle Purus <i>Cat.ZA Leather Purus</i>	270,00	
D42762G053	Cat.ZS Pelle Sacramento <i>Cat.ZS Leather Sacramento</i>	285,00	
D42762G051	Cat.ZC Pelle Churchill <i>Cat.ZC Leather Churchill</i>	295,00	



PER LA SCELTA DEI TESSUTI E PELLI CONSULTARE IL LIBRO "ABBINAMENTO TESSUTI-PELLI/MATERIALI"

FOR THE CHOICE OF FABRICS AND LEATHERS, SEE BOOK "MATCHING FABRICS-LEATHERS/MATERIALS"

CUSCINI DECORATIVI/THROW CUSHIONS by Driade Lab

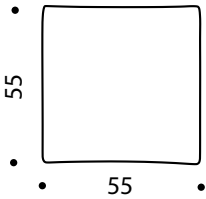
Modello Model	Codice Code	Categoria materiale - Descrizione materiale Material category - Material description	Prezzo Retail con Iva Retail price with Vat
<p>Cuscini in piuma (parte interna) e tela d'uovo (parte esterna). Rivestimento sfoderabile in tessuto, fisso in pell . Uso solo interno. L. 55 H. 55; P.L. 1,2 Kg; V. 0,10 mc</p> <p><i>Inner part of the cushions in goose down and outer part in eggskin. Removable cover in fabric, fixed in leather. Indoor use only. W. 55 H. 55; G.W. 1,2 Kg; V. 0,10 cbm</i></p> 	D42753G700	Cat.A Cotone Bonifacio <i>Cat.A Cotton Bonifacio</i>	180,00
	D42753G701	Cat.A Poliestere Marsiglia <i>Cat.A Polyester Marsiglia</i>	
	D42753G702	Cat.A misto Poliestere, Acrilico, Cotone Petra <i>Cat.A mixed Polyester, Acrylic, Cotton Petra</i>	
	D42753G703	Cat.A misto Poliestere, Acrilico, Cotone Damasco <i>Cat.A mixed Polyester, Acrylic, Cotton Damasco</i>	
	D42753G028	Cat.A Ecopelle Colorado <i>Cat.A Eco-leather Colorado</i>	
	D42753G704	Cat.B misto Poliestere, Acrilico, Cotone Berlino <i>Cat.B mixed Polyester, Acrylic, Cotton Berlino</i>	205,00
	D42753G705	Cat.B Poliestere Jakarta <i>Cat.B Polyester Jakarta</i>	
	D42753G706	Cat.B Poliestere Ginevra <i>Cat.B Polyester Ginevra</i>	
	D42753G032	Cat.C Velluto di cotone Loira <i>Cat.C Cotton Velvet Loira</i>	215,00
	D42753G036	Cat.C Misto Lino Lisbona <i>Cat.C Linen Mix Lisbona</i>	
D42753G040	Cat.C Lino Barcellona <i>Cat.C Linen Barcellona</i>		
D42753G709	Cat.C Polipropilene Amburgo <i>Cat.C Polypropylene Amburgo</i>		
D42753G710	Cat.C misto Poliestere, Acrilico, Cotone, Lana, Viscosa Berna <i>Cat.C mixed Polyester, Acrylic, Cotton, Wool, Viscose Berna</i>		
D42753G719	Cat.C Poliestere Mosca <i>Cat.C Polyester Mosca</i>		
D42753G712	Cat.D Lana vergine, Cotone, Poliammide Malmö <i>Cat.D virgin Wool, Cotton, Polyamide Malmö</i>	240,00	
D42753G713	Cat.E Lana Divina Melange Kvadrat <i>Cat.E Wool Divina Melange Kvadrat</i>	285,00	
D42753G714	Cat.E Cotone Venezia <i>Cat.E Cotton Venezia</i>		
D42753G717	Cat.E Modacrilica, Poliestere Pechino <i>Cat.E Modacrylic, Polyester Pechino</i>		
D42753G718	Cat.E Modacrilica, Poliestere Mongolia <i>Cat.E Modacrylic, Polyester Mongolia</i>		
D42753G050	Cat.P Pelle Niagara <i>Cat.P Leather Niagara</i>	270,00	
D42753G049	Cat.O Pelle Rio <i>Cat.O Leather Rio</i>	295,00	
D42753G052	Cat.ZME Pelle Amur <i>Cat.ZME Leather Amur</i>	315,00	
D42753G054	Cat.ZA Pelle Purus <i>Cat.ZA Leather Purus</i>	370,00	
D42753G053	Cat.ZS Pelle Sacramento <i>Cat.ZS Leather Sacramento</i>	410,00	
D42753G051	Cat.ZC Pelle Churchill <i>Cat.ZC Leather Churchill</i>	420,00	

PER LA SCELTA DEI TESSUTI E PELLI CONSULTARE IL LIBRO "ABBINAMENTO TESSUTI-PELLI/MATERIALI"

FOR THE CHOICE OF FABRICS AND LEATHERS, SEE BOOK "MATCHING FABRICS-LEATHERS/MATERIALS"

CUSCINI DECORATIVI/THROW CUSHIONS by Driade Lab

Modello Model	Codice Code	Categoria materiale - Descrizione materiale Material category - Material description	Prezzo Retail con Iva Retail price with Vat
<p>Cuscini in piuma (parte interna) e tela d'uovo (parte esterna). Rivestimento sfoderabile in tessuto, fisso in pell . Uso solo interno. L. 65 H. 65; P.L. xx Kg; V. xx mc</p> <p><i>Inner part of the cushions in goose down and outer part in eggskin. Removable cover in fabric, fixed in leather. Indoor use only. W. 65 H. 65; G.W. xx Kg; V. xxcbm</i></p>	D42755G700	Cat.A Cotone Bonifacio <i>Cat.A Cotton Bonifacio</i>	215,00
	D42755G701	Cat.A Poliestere Marsiglia <i>Cat.A Polyester Marsiglia</i>	
	D42755G702	Cat.A misto Poliestere, Acrilico, Cotone Petra <i>Cat.A mixed Polyester, Acrylic, Cotton Petra</i>	
	D42755G703	Cat.A misto Poliestere, Acrilico, Cotone Damasco <i>Cat.A mixed Polyester, Acrylic, Cotton Damasco</i>	
	D42755G028	Cat.A Ecopelle Colorado <i>Cat.A Eco-leather Colorado</i>	
	D42755G704	Cat.B misto Poliestere, Acrilico, Cotone Berlino <i>Cat.B mixed Polyester, Acrylic, Cotton Berlino</i>	245,00
	D42755G705	Cat.B Poliestere Jakarta <i>Cat.B Polyester Jakarta</i>	
	D42755G706	Cat.B Poliestere Ginevra <i>Cat.B Polyester Ginevra</i>	
	D42755G032	Cat.C Velluto di cotone Loira <i>Cat.C Cotton Velvet Loira</i>	285,00
	D42755G036	Cat.C Misto Lino Lisbona <i>Cat.C Linen Mix Lisbona</i>	
D42755G040	Cat.C Lino Barcellona <i>Cat.C Linen Barcellona</i>		
D42755G709	Cat.C Polipropilene Amburgo <i>Cat.C Polypropylene Amburgo</i>		
D42755G710	Cat.C misto Poliestere, Acrilico, Cotone, Lana, Viscosa Berna <i>Cat.C mixed Polyester, Acrylic, Cotton, Wool, Viscose Berna</i>		
D42755G719	Cat.C Poliestere Mosca <i>Cat.C Polyester Mosca</i>		
D42755G712	Cat.D Lana vergine, Cotone, Poliammide Malmö <i>Cat.D virgin Wool, Cotton, Polyamide Malmö</i>	320,00	
D42755G713	Cat.E Lana Divina Melange Kvadrat <i>Cat.E Wool Divina Melange Kvadrat</i>	395,00	
D42755G714	Cat.E Cotone Venezia <i>Cat.E Cotton Venezia</i>		
D42755G717	Cat.E Modacrilica, Poliestere Pechino <i>Cat.E Modacrylic, Polyester Pechino</i>		
D42755G718	Cat.E Modacrilica, Poliestere Mongolia <i>Cat.E Modacrylic, Polyester Mongolia</i>		
D42755G050	Cat.P Pelle Niagara <i>Cat.P Leather Niagara</i>	380,00	
D42755G049	Cat.O Pelle Rio <i>Cat.O Leather Rio</i>	440,00	
D42755G052	Cat.ZME Pelle Amur <i>Cat.ZME Leather Amur</i>	525,00	
D42755G054	Cat.ZA Pelle Purus <i>Cat.ZA Leather Purus</i>	565,00	
D42755G053	Cat.ZS Pelle Sacramento <i>Cat.ZS Leather Sacramento</i>	610,00	
D42755G051	Cat.ZC Pelle Churchill <i>Cat.ZC Leather Churchill</i>	705,00	

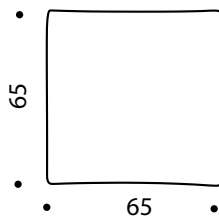

PER LA SCELTA DEI TESSUTI E PELLI CONSULTARE IL LIBRO "ABBINAMENTO TESSUTI-PELLI/MATERIALI"

FOR THE CHOICE OF FABRICS AND LEATHERS, SEE BOOK "MATCHING FABRICS-LEATHERS/MATERIALS"

CUSCINI DECORATIVI/THROW CUSHIONS by Driade Lab

Modello Model	Codice Code	Categoria materiale - Descrizione materiale Material category - Material description	Prezzo Retail con Iva Retail price with Vat
<p>Cuscini in piuma (parte interna) e tela d'uovo (parte esterna). Rivestimento sfoderabile in tessuto, fisso in pell . Uso solo interno. Ø 15 H. 50; P.L. 2,3 Kg; V. 0,10 mc</p> <p><i>Inner part of the cushions in goose down and outer part in eggskin. Removable cover in fabric, fixed in leather. Indoor use only. Ø 15 H. 50; G.W. 2,3 Kg; V. 0,10 cbm</i></p>	D42787G700	Cat.A Cotone Bonifacio <i>Cat.A Cotton Bonifacio</i>	125,00
	D42787G701	Cat.A Poliestere Marsiglia <i>Cat.A Polyester Marsiglia</i>	
	D42787G702	Cat.A misto Poliestere, Acrilico, Cotone Petra <i>Cat.A mixed Polyester, Acrylic, Cotton Petra</i>	
	D42787G703	Cat.A misto Poliestere, Acrilico, Cotone Damasco <i>Cat.A mixed Polyester, Acrylic, Cotton Damasco</i>	
	D42787G028	Cat.A Ecopelle Colorado <i>Cat.A Eco-leather Colorado</i>	
	D42787G704	Cat.B misto Poliestere, Acrilico, Cotone Berlino <i>Cat.B mixed Polyester, Acrylic, Cotton Berlino</i>	145,00
	D42787G705	Cat.B Poliestere Jakarta <i>Cat.B Polyester Jakarta</i>	
	D42787G706	Cat.B Poliestere Ginevra <i>Cat.B Polyester Ginevra</i>	
	D42787G032	Cat.C Velluto di cotone Loira <i>Cat.C Cotton Velvet Loira</i>	160,00
	D42787G036	Cat.C Misto Lino Lisbona <i>Cat.C Linen Mix Lisbona</i>	
D42787G040	Cat.C Lino Barcellona <i>Cat.C Linen Barcellona</i>		
D42787G709	Cat.C Polipropilene Amburgo <i>Cat.C Polypropylene Amburgo</i>		
D42787G710	Cat.C misto Poliestere, Acrilico, Cotone, Lana, Viscosa Berna <i>Cat.C mixed Polyester, Acrylic, Cotton, Wool, Viscose Berna</i>		
D42787G719	Cat.C Poliestere Mosca <i>Cat.C Polyester Mosca</i>		
D42787G712	Cat.D Lana vergine, Cotone, Poliammide Malmö <i>Cat.D virgin Wool, Cotton, Polyamide Malmö</i>	170,00	
D42787G713	Cat.E Lana Divina Melange Kvadrat <i>Cat.E Wool Divina Melange Kvadrat</i>	200,00	
D42787G714	Cat.E Cotone Venezia <i>Cat.E Cotton Venezia</i>		
D42787G717	Cat.E Modacrilica, Poliestere Pechino <i>Cat.E Modacrylic, Polyester Pechino</i>		
D42787G718	Cat.E Modacrilica, Poliestere Mongolia <i>Cat.E Modacrylic, Polyester Mongolia</i>		
D42787G050	Cat.P Pelle Niagara <i>Cat.P Leather Niagara</i>	190,00	
D42787G049	Cat.O Pelle Rio <i>Cat.O Leather Rio</i>	215,00	
D42787G052	Cat.ZME Pelle Amur <i>Cat.ZME Leather Amur</i>	230,00	
D42787G054	Cat.ZA Pelle Purus <i>Cat.ZA Leather Purus</i>	270,00	
D42787G053	Cat.ZS Pelle Sacramento <i>Cat.ZS Leather Sacramento</i>	275,00	
D42787G051	Cat.ZC Pelle Churchill <i>Cat.ZC Leather Churchill</i>	285,00	

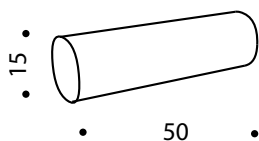

PER LA SCELTA DEI TESSUTI E PELLI CONSULTARE IL LIBRO "ABBINAMENTO TESSUTI-PELLI/MATERIALI"

FOR THE CHOICE OF FABRICS AND LEATHERS, SEE BOOK "MATCHING FABRICS-LEATHERS/MATERIALS"

**TAVOLI/
*TABLES***

ANAPO
by Gordon Guillaumier
2014
Tavolo

Tavolo con base in acciaio verniciato di colore nero RAL 9005* e piano in vetro temperato spessore 15 mm. o in mdf con finitura in marmo bianco Carrara, marmo rosso Lepanto, marmo verde Alpi oppure marmo Galaxy nero. Uso solo interno.





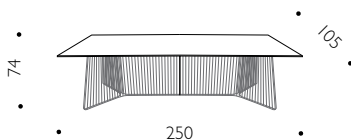





Table

Table with black (RAL 9005*) painted steel structure and tempered glass th.15 mm., Carrara marble, red Lepanto marble, green Alpi marble or black Galaxy marble, white top. Indoor use only.



L. 250 P. 105 H. 74
W. 250 D. 105 H. 74
Struttura: P.L. 42 Kg; V. 1,549 mc
Structure: G.W. 42 Kg; V. 1,549 cbm



Codice Code	Colore Color	Prezzo Retail con Iva Retail price with Vat	Codice campione Sample code	Campionario nr. Sample box n.	Codice Code	Colore Color	Prezzo Retail con Iva Retail price with Vat	Codice campione Sample code	Campionario nr. Sample box n.
D221011361B04		4.750,00			D221011762656		10.200,00		
Piano: P.L. 82 Kg; V. 1,942 mc Top: G.W. 82 Kg; V. 1,942 cbm					Piano: P.L. 205 Kg; V. 1,942 mc Top: G.W. 205 Kg; V. 1,942 cbm				
	Vetro trasparente Transparent glass		ND/NA			Marmo verde Alpi Green Alpi marble		MAR00201	8
	Acciaio vern. Nero Ral. 9005 opaco Painted steel matt Black Ral 9005		VER09103	7		Acciaio vern. Nero Ral. 9005 opaco Painted steel matt Black Ral 9005		VER09103	7
D221011363596		8.700,00			D221011792632		11.900,00		
Piano: P.L. 205 Kg; V. 1,942 mc Top: G.W. 205 Kg; V. 1,942 cbm					Piano: P.L. 205 Kg; V. 1,942 mc Top: G.W. 205 Kg; V. 1,942 cbm				
	Marmo Carrara Bianco levigato White polished Carrara marble		MAR00201	8		Marmo nero Galaxy Black Galaxy marble		xxxxxx	8
	Acciaio vern. Nero Ral. 9005 opaco Painted steel matt Black Ral 9005		VER09103	7		Acciaio vern. Nero Ral. 9005 opaco Painted steel matt Black Ral 9005		VER09103	7
D221011735647		11.500,00							
Piano: P.L. 205 Kg; V. 1,942 mc Top: G.W. 205 Kg; V. 1,942 cbm									
	Marmo rosso Lepanto Red Lepanto marble		xxxxxx	8					
	Acciaio vern. Nero Ral. 9005 opaco Painted steel matt Black Ral 9005		VER09103	7					

ANAPO
by Gordon Guillaumier
2014

Tavolo

Tavolo con base in acciaio verniciato di colore nero RAL 9005* e piano in vetro temperato spessore 15 mm. Uso solo interno.

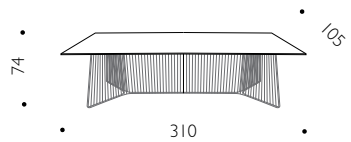

Table

Table with black (RAL 9005*) painted steel structure and tempered glass th.15 mm. top. Indoor use only.



L. 310 P. 105 H. 74
W. 310 D. 105 H. 74
Struttura: P.L. 48 Kg; V. 2,305 mc
Structure: G.W. 48 Kg; V. 2,305 cbm

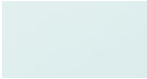

Codice Code	Colore Color	Prezzo Retail con Iva Retail price with Vat	Codice campione Sample code	Campionario nr. Sample box n.
D221031361B04		5.650,00		
Piano: P.L. 204 Kg; V. 2,408 mc Top: G.W. 204 Kg; V. 2,408 cbm				
	Vetro trasparente Transparent glass		ND/NA	
	Acciaio vern. Nero Ral. 9005 opaco Painted steel matt Black Ral 9005		VER091O3	7

CUGINO
by Enzo Mari
1974

Tavolo

Struttura in profilati di acciaio verniciati di colore nero antracite. Piano circolare o quadrato in vetro temperato, spessore 12 mm.
Uso solo interno.

Table

Black anthracite painted steel sections structure with round or square tempered glass th 12 mm. top. Indoor use only.



Tavolo circolare/
Round table



Tavolo quadrato/
Square table

Struttura: P.L. 25 Kg; V. 0,104 mc
Structure G.W. 25 Kg; V. 0,104 cbm



Vetro trasparente
Transparent glass

Codice campione
Sample code

ND/NA

Campionario nr.
Sample box n.



Acciaio verniciato Nero antracite
Anthracite Black painted steel

VER05701

7

ø 106 H. 72
ø 106 H. 72;
Piano: P.L. 45 Kg; V. 0,052 mc
Top: G.W. 45 Kg; V. 0,052 cbm

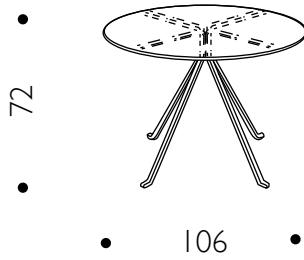

Codice
Code

D49814V361B04

Prezzo Retail con Iva
Retail price with Vat

1.750,00

ø 120 H. 72
ø 120 H. 72;
Piano: P.L. 56 Kg; V. 0,065 mc
Top: G.W. 56 Kg; V. 0,065 cbm

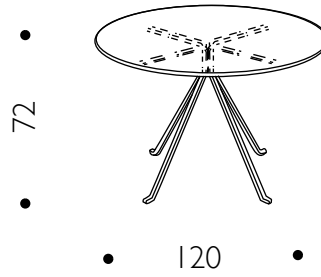

Codice
Code

D49816V361B04

Prezzo Retail con Iva
Retail price with Vat

1.900,00

ø 130 H. 72
ø 130 H. 72;
Piano: P.L. 58 Kg; V. 0,077 mc
Top: G.W. 58 Kg; V. 0,077 cbm

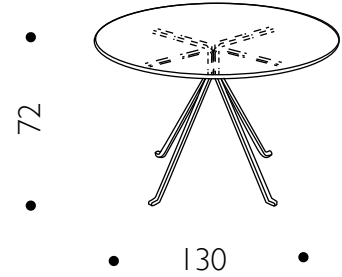

Codice
Code

D49817V361B04

Prezzo Retail con Iva
Retail price with Vat

2.200,00

L. 80 P. 80 H. 72
W. 80 D. 80 H. 72;
Piano: P.L. 28 Kg; V. 0,040 mc
Top: G.W. 28 Kg; V. 0,040 cbm

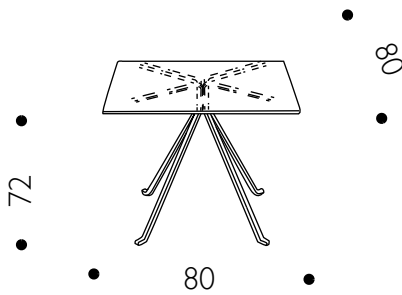

Codice
Code

D49822V361B04

Prezzo Retail con Iva
Retail price with Vat

1.490,00

L. 90 P. 90 H. 72
W. 90 D. 90 H. 72;
Piano: P.L. 35 Kg; V. 0,040 mc
Top: G.W. 35 Kg; V. 0,040 cbm

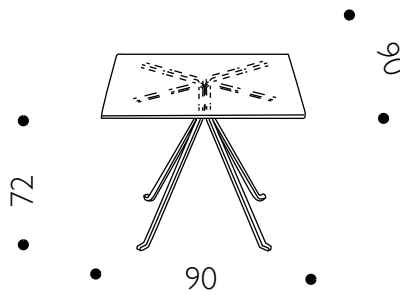

Codice
Code

D49823V361B04

Prezzo Retail con Iva
Retail price with Vat

1.590,00

L. 100 P. 100 H. 72
W. 100 D. 100 H. 72;
Piano: P.L. 43 Kg; V. 0,047 mc
Top: G.W. 43 Kg; V. 0,047 cbm

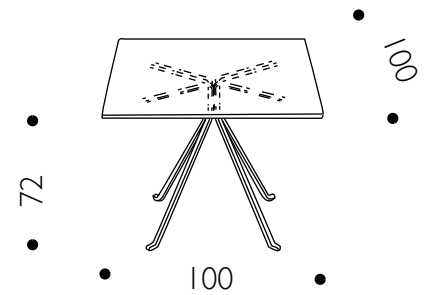

Codice
Code

D49824V361B04

Prezzo Retail con Iva
Retail price with Vat

1.700,00

L. 120 P. 120 H. 72
W. 120 D. 120 H. 72;
Piano: P.L. 62 Kg; V. 0,066 mc
Top: G.W. 62 Kg; V. 0,066 cbm

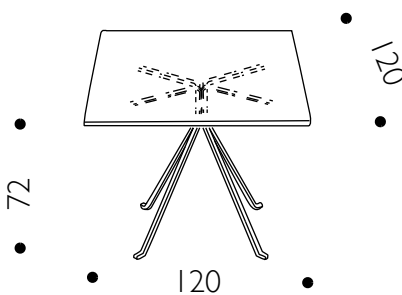

Codice
Code

D49826V361B04

Prezzo Retail con Iva
Retail price with Vat

1.850,00

DIDYMOS

 by Antonia Astori
2011

Tavolo







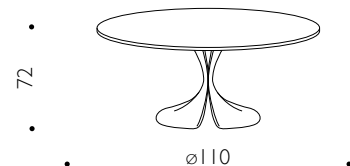



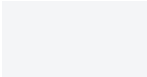
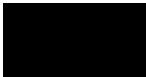







Tavolo con base scultorea in Cristalplant bianco o verniciata nero opaco. Piani in particelle di legno spessore 30mm. rivestito in bilaminato bianco o nero con bordo sagomato oppure in marmo bianco Carrara lucido, nero Marquina, rosso Lepanto, Verde Alpi oppure Galaxy nero. Uso solo interno.

Table

Table with sculptural base in white cristalplant or matt black lacquered. Wooden particles tops covered with white or black bilaminated or glossy white Carrara, red Lepanto, green Alpi or black Galaxy marble. Indoor use only.



ø 110 H. 72; Base: P.L. 42 Kg; V. 0,380 mc
ø 110 H. 72; Base: G.W. 42 Kg; V. 0,380 cbm

Codice Code	Colore Color	Prezzo Retail con Iva Retail price with Vat	Codice campione Sample code	Campionario nr. Sample box n.	Codice Code	Colore Color	Prezzo Retail con Iva Retail price with Vat	Codice campione Sample code	Campionario nr. Sample box n.
D61045V343002		3.650,00			D61045V344091		4.250,00		
Piano MDF: P.L. 21 Kg; V. 0,10 mc MDF top: G.W. 21 Kg; V. 0,10 cbm					Piano MDF: P.L. 21 Kg; V. 0,10 mc MDF top: G.W. 21 Kg; V. 0,10 cbm				
	Laminato Bianco laccato White lacquered Laminated		LATUN002O1	10		Laminato Nero laccato Black lacquered Laminated		LATUN091O1	10
	Cristalplant Bianco White Cristalplant		RES002O1	8		Cristalplant Nero Ral. 9005 opaco Matt Black Ral 9005 Cristalplant		VER091O3	7
D61045V341002		7.000,00			D61045V342091		7.000,00		
Piano marmo: P.L. 74 Kg; V. 0,25 mc Marble top: G.W. 74 Kg; V. 0,25 cbm					Piano marmo: P.L. 74 Kg; V. 0,25 mc Marble top: G.W. 74 Kg; V. 0,25 cbm				
	Marmo Carrara Bianco levigato White polished Carrara marble		MAR002O1	8		Marmo Marquina Nero lucido Black polished Marquina marble		MAR002O1	8
	Cristalplant Bianco White Cristalplant		RES002O1	8		Cristalplant Nero Ral. 9005 opaco Matt Black Ral 9005 Cristalplant		VER091O3	6
D61045V748704		8.400,00			D61045V744647		9.100,00		
Piano marmo: P.L. 74 Kg; V. 0,25 mc Marble top: G.W. 74 Kg; V. 0,25 cbm					Piano marmo: P.L. 74 Kg; V. 0,25 mc Marble top: G.W. 74 Kg; V. 0,25 cbm				
	Marmo rosso Lepanto Green Alpi marble		ND/NA			Marmo rosso Lepanto Green Alpi marble		ND/NA	
	Cristalplant Bianco White Cristalplant		RES002O1	8		Cristalplant Nero Ral. 9005 opaco Matt Black Ral 9005 Cristalplant		VER091O3	6
D61045V775710		7.500,00			D61045V774656		8.000,00		
Piano marmo: P.L. 74 Kg; V. 0,25 mc Marble top: G.W. 74 Kg; V. 0,25 cbm					Piano marmo: P.L. 74 Kg; V. 0,25 mc Marble top: G.W. 74 Kg; V. 0,25 cbm				
	Marmo verde Alpi Green Alpi marble		ND/NA			Marmo verde Alpi Green Alpi marble		ND/NA	
	Cristalplant Bianco White Cristalplant		RES002O1	8		Cristalplant Nero Ral. 9005 opaco Matt Black Ral 9005 Cristalplant		VER091O3	6
D61045V799694		8.650,00			D61045V798632		9.300,00		
Piano marmo: P.L. 74 Kg; V. 0,25 mc Marble top: G.W. 74 Kg; V. 0,25 cbm					Piano marmo: P.L. 74 Kg; V. 0,25 mc Marble top: G.W. 74 Kg; V. 0,25 cbm				
	Marmo nero Galaxy Black Galaxy marble		ND/NA			Marmo nero Galaxy Black Galaxy marble		ND/NA	
	Cristalplant Bianco White Cristalplant		RES002O1	8		Cristalplant Nero Ral. 9005 opaco Matt Black Ral 9005 Cristalplant		VER091O3	6

DIDYMOS
by Antonia Astori
2011
Tavolo







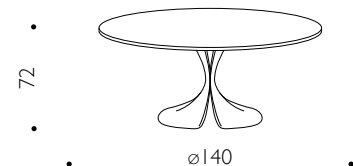



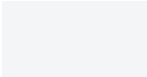
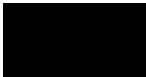



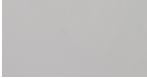



Tavolo con base scultorea in Cristalplant bianco o verniciata nero opaco. Piani in particelle di legno spessore 30mm. rivestito in bilaminato bianco o nero con bordo sagomato oppure in marmo bianco Carrara lucido, nero Marquina, rosso Lepanto, Verde Alpi oppure Galaxy nero. Uso solo interno.

Table

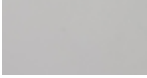
Table with sculptural base in white cristalplant or matt black lacquered. Wooden particles tops covered with white or black bilaminated or glossy white Carrara, red Lepanto, green Alpi or black Galaxy marble. Indoor use only.



ø 140 H. 72; Base: P.L. 42 Kg; V. 0,380 mc
ø 140 H. 72; Base: G.W. 42 Kg; V. 0,380 cbm

Codice Code	Colore Color	Prezzo Retail con Iva Retail price with Vat	Codice campione Sample code	Campionario nr. Sample box n.	Codice Code	Colore Color	Prezzo Retail con Iva Retail price with Vat	Codice campione Sample code	Campionario nr. Sample box n.
D61047V343002		4.100,00			D61047V344091		4.720,00		
Piano MDF: P.L. 34 Kg; V. 0,20 mc MDF top: G.W. 34 Kg; V. 0,20 cbm					Piano MDF: P.L. 34 Kg; V. 0,20 mc MDF top: G.W. 34 Kg; V. 0,20 cbm				
	Laminato Bianco laccato White lacquered Laminated		LATUN00201	10		Laminato Nero laccato Black lacquered Laminated		LATUN09101	10
	Cristalplant Bianco White Cristalplant		RES00201	8		Cristalplant Nero Ral. 9005 opaco Matt Black Ral 9005 Cristalplant		VER09103	7
D61047V341002		7.350,00			D61047V342091		7.350,00		
Piano marmo: P.L. 110 Kg; V. 0,35 mc Marble top: G.W. 110 Kg; V. 0,35 cbm					Piano marmo: P.L. 110 Kg; V. 0,35 mc Marble top: G.W. 110 Kg; V. 0,35 cbm				
	Marmo Carrara Bianco levigato White polished Carrara marble		MAR00201	8		Marmo Marquina Nero lucido Black polished Marquina marble		MAR00201	8
	Cristalplant Bianco White Cristalplant		RES00201	8		Cristalplant Nero Ral. 9005 opaco Matt Black Ral 9005 Cristalplant		VER09103	6
D61047V748704		8.800,00			D61047V744647		9.500,00		
Piano marmo: P.L. 110 Kg; V. 0,35 mc Marble top: G.W. 110 Kg; V. 0,35 cbm					Piano marmo: P.L. 110 Kg; V. 0,35 mc Marble top: G.W. 110 Kg; V. 0,35 cbm				
	Marmo rosso Lepanto Red Lepanto marble		ND/NA			Marmo rosso Lepanto Red Lepanto marble		ND/NA	
	Cristalplant Bianco White Cristalplant		RES00201	8		Cristalplant Nero Ral. 9005 opaco Matt Black Ral 9005 Cristalplant		VER09103	6
D61047V775710		7.800,00			D61047V774656		8.500,00		
Piano marmo: P.L. 110 Kg; V. 0,35 mc					Piano MDF: P.L. 34 Kg; V. 0,20 mc MDF top: G.W. 34 Kg; V. 0,20 cbm				
	Marmo verde Alpi Green Alpi marble		ND/NA			Marmo verde Alpi Green Alpi marble		ND/NA	
	Cristalplant Bianco White Cristalplant		RES00201	8		Cristalplant Nero Ral. 9005 opaco Matt Black Ral 9005 Cristalplant		VER09103	6
D61047V799694		9.000,00			D61047V798632		9.700,00		
Piano marmo: P.L. 110 Kg; V. 0,35 mc					Piano MDF: P.L. 34 Kg; V. 0,20 mc MDF top: G.W. 34 Kg; V. 0,20 cbm				
	Marmo nero Galaxy Black Galaxy marble		ND/NA			Marmo nero Galaxy Black Galaxy marble		ND/NA	
	Cristalplant Bianco White Cristalplant		RES00201	8		Cristalplant Nero Ral. 9005 opaco Matt Black Ral 9005 Cristalplant		VER09103	6

DIDYMOS
by Antonia Astori
2011
Tavolo







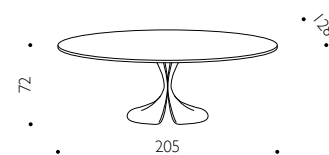



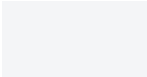
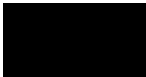



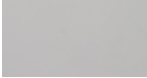



Tavolo con base scultorea in Cristalplant bianco o verniciata nero opaco. Piani in particelle di legno spessore 30mm. rivestito in bilaminato bianco o nero con bordo sagomato oppure in marmo bianco Carrara lucido, nero Marquina, rosso Lepanto, Verde Alpi oppure Galaxy nero. Uso solo interno.

Table

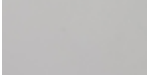
Table with sculptural base in white cristalplant or matt black lacquered. Wooden particles tops covered with white or black bilaminated or glossy white Carrara, red Lepanto, green Alpi or black Galaxy marble. Indoor use only.



L. 205 P. 128 H. 72; Base: P.L. 42 Kg; V. 0,380 mc
W. 205 D. 128 H. 72; Base: G.W. 42 Kg; V. 0,380 cbm

Codice Code	Colore Color	Prezzo Retail con Iva Retail price with Vat	Codice campione Sample code	Campionario nr. Sample box n.	Codice Code	Colore Color	Prezzo Retail con Iva Retail price with Vat	Codice campione Sample code	Campionario nr. Sample box n.
D61000I343002		4.610,00			D61000I344091		5.200,00		
Piano MDF: P.L. 46 Kg; V. 0,25 mc MDF top: G.W. 46 Kg; V. 0,25 cbm					Piano MDF: P.L. 46 Kg; V. 0,25 mc MDF top: G.W. 46 Kg; V. 0,25 cbm				
	Laminato Bianco laccato White lacquered Laminated		LATUN002O1	10		Laminato Nero laccato Black lacquered Laminated		LATUN091O1	10
	Cristalplant Bianco White Cristalplant		RES002O1	8		Cristalplant Nero Ral. 9005 opaco Matt Black Ral 9005 Cristalplant		VER091O3	7
D61000I341002		10.000,00			D61000I342091		10.000,00		
Piano marmo: P.L. 143 Kg; V. 0,45 mc Marble top: G.W. 143 Kg; V. 0,45 cbm					Piano marmo: P.L. 143 Kg; V. 0,45 mc Marble top: G.W. 143 Kg; V. 0,45 cbm				
	Marmo Carrara Bianco levigato White polished Carrara marble		MAR002O1	8		Marmo Marquina Nero lucido Black polished Marquina marble		MAR002O1	8
	Cristalplant Bianco White Cristalplant		RES002O1	8		Cristalplant Nero Ral. 9005 opaco Matt Black Ral 9005 Cristalplant		VER091O3	7
D61000I748704		12.000,00			D61000I744647		12.900,00		
Piano marmo: P.L. 143 Kg; V. 0,45 mc Marble top: G.W. 143 Kg; V. 0,45 cbm					Piano marmo: P.L. 143 Kg; V. 0,45 mc Marble top: G.W. 143 Kg; V. 0,45 cbm				
	Marmo rosso Lepanto Red Lepanto marble		ND/NA			Marmo rosso Lepanto Red Lepanto marble		ND/NA	
	Cristalplant Bianco White Cristalplant		RES002O1	8		Cristalplant Nero Ral. 9005 opaco Matt Black Ral 9005 Cristalplant		VER091O3	6
D61000I775710		11.000,00			D61000I774656		11.500,00		
Piano marmo: P.L. 143 Kg; V. 0,45 mc Marble top: G.W. 143 Kg; V. 0,45 cbm					Piano marmo: P.L. 143 Kg; V. 0,45 mc Marble top: G.W. 143 Kg; V. 0,45 cbm				
	Marmo verde Alpi Green Alpi marble		ND/NA			Marmo verde Alpi Green Alpi marble		ND/NA	
	Cristalplant Bianco White Cristalplant		RES002O1	8		Cristalplant Nero Ral. 9005 opaco Matt Black Ral 9005 Cristalplant		VER091O3	6
D61000I799694		12.360,00			D61000I798632		13.300,00		
Piano marmo: P.L. 143 Kg; V. 0,45 mc Marble top: G.W. 143 Kg; V. 0,45 cbm					Piano marmo: P.L. 143 Kg; V. 0,45 mc Marble top: G.W. 143 Kg; V. 0,45 cbm				
	Marmo nero Galaxy Black Galaxy marble		ND/NA			Marmo nero Galaxy Black Galaxy marble		ND/NA	
	Cristalplant Bianco White Cristalplant		RES002O1	8		Cristalplant Nero Ral. 9005 opaco Matt Black Ral 9005 Cristalplant		VER091O3	6

DIDYMOS
by Antonia Astori
2011
Tavolo







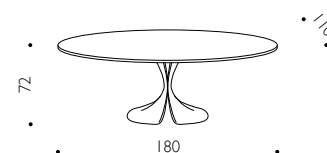



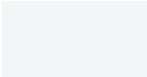
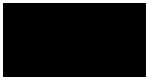



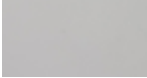



Tavolo con base scultorea in Cristalplant bianco o verniciata nero opaco. Piani in particelle di legno spessore 30mm. rivestito in bilaminato bianco o nero con bordo sagomato oppure in marmo bianco Carrara lucido, nero Marquina, rosso Lepanto, Verde Alpi oppure Galaxy nero. Uso solo interno.

Table

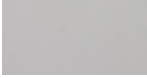
Table with sculptural base in white cristalplant or matt black lacquered. Wooden particles tops covered with white or black bilaminated or glossy white Carrara, red Lepanto, green Alpi or black Galaxy marble. Indoor use only.



L. 180 P. 110 H. 72; Base: P.L. 42 Kg; V. 0,380 mc
W. 180 D. 110 H. 72; Base: G.W. 42 Kg; V. 0,380 cbm

Codice Code	Colore Color	Prezzo Retail con Iva Retail price with Vat	Codice campione Sample code	Campionario nr. Sample box n.	Codice Code	Colore Color	Prezzo Retail con Iva Retail price with Vat	Codice campione Sample code	Campionario nr. Sample box n.
D61009H343002		4.200,00			D61009H344091		4.700,00		
Piano MDF: P.L. 34 Kg; V. 0,20 mc MDF top: G.W. 34 Kg; V. 0,20 cbm					Piano MDF: P.L. 34 Kg; V. 0,20 mc MDF top: G.W. 34 Kg; V. 0,20 cbm				
	Laminato Bianco laccato White lacquered Laminated		LATUN002O1	10		Laminato Nero laccato Black lacquered Laminated		LATUN091O1	10
	Cristalplant Bianco White Cristalplant		RES002O1	8		Cristalplant Nero Ral. 9005 opaco Matt Black Ral 9005 Cristalplant		VER091O3	7
D61009H341002		9.550,00			D61009H342091		9.550,00		
Piano marmo: P.L. 110 Kg; V. 0,35 mc Marble top: G.W. 110 Kg; V. 0,35 cbm					Piano marmo: P.L. 110 Kg; V. 0,35 mc Marble top: G.W. 110 Kg; V. 0,35 cbm				
	Marmo Carrara Bianco levigato White polished Carrara marble		MAR002O1	8		Marmo Marquina Nero lucido Black polished Marquina marble		MAR002O1	8
	Cristalplant Bianco White Cristalplant		RES002O1	8		Cristalplant Nero Ral. 9005 opaco Matt Black Ral 9005 Cristalplant		VER091O3	7
D61009H748704		11.500,00			D61009H744647		12.500,00		
Piano marmo: P.L. 110 Kg; V. 0,35 mc Marble top: G.W. 110 Kg; V. 0,35 cbm					Piano marmo: P.L. 110 Kg; V. 0,35 mc Marble top: G.W. 110 Kg; V. 0,35 cbm				
	Marmo rosso Lepanto Red Lepanto marble		ND/NA			Marmo rosso Lepanto Red Lepanto marble		ND/NA	
	Cristalplant Bianco White Cristalplant		RES002O1	8		Cristalplant Nero Ral. 9005 opaco Matt Black Ral 9005 Cristalplant		VER091O3	6
D61009H775710		10.400,00			D61009H774656		11.000,00		
Piano MDF: P.L. 34 Kg; V. 0,20 mc MDF top: G.W. 34 Kg; V. 0,20 cbm					Piano MDF: P.L. 34 Kg; V. 0,20 mc MDF top: G.W. 34 Kg; V. 0,20 cbm				
	Marmo verde Alpi Green Alpi marble		ND/NA			Marmo verde Alpi Green Alpi marble		ND/NA	
	Cristalplant Bianco White Cristalplant		RES002O1	8		Cristalplant Nero Ral. 9005 opaco Matt Black Ral 9005 Cristalplant		VER091O3	6
D61009H799694		12.800,00			D61009H798632		13.800,00		
Piano MDF: P.L. 34 Kg; V. 0,20 mc MDF top: G.W. 34 Kg; V. 0,20 cbm					Piano MDF: P.L. 34 Kg; V. 0,20 mc MDF top: G.W. 34 Kg; V. 0,20 cbm				
	Marmo nero Galaxy Black Galaxy marble		ND/NA			Marmo nero Galaxy Black Galaxy marble		ND/NA	
	Cristalplant Bianco White Cristalplant		RES002O1	8		Cristalplant Nero Ral. 9005 opaco Matt Black Ral 9005 Cristalplant		VER091O3	6

EASEL

by Ludovca+Roberto
Palomba
2016

Tavolo

Base in massello di noce canaletto con piano listellare spessore 30 mm impiallacciato in noce canaletto smussato nella parte inferiore. Base in massello di noce canaletto o frassino ebanizzato con piano in vetro chiaro temperato spessore 12 o 15 mm. oppure in marmo lucido bianco Carrara, nero Marquina, rosso Lepanto, verde Alpi o Galaxy nero. Uso solo interno.

Table

Base in solid Canaletto walnut wood. Bevelled striped top with Canaletto walnut veneer in the lower side thickness 30 mm. Base in solid Canaletto walnut wood or ebonized ash wood with transparent tempered glass top th. 12 or 15 mm. or with glossy white Carrara, black Marquina, red Lepanto, green Alpi or black Galaxy marbl etop. Indoor use only.



Impiallacciato noce/Noce
Veneered walnut/Walnut



Vetro/Noce
Glass/Walnut



Vetro/Frassino
Glass/Ash



Marmo Carrara/Noce
Carrara marble/Walnut











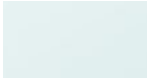
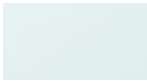









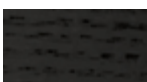

Marmo Marquina/Frassino
Marquina marble/Ash

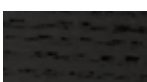



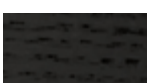

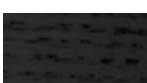

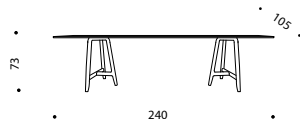



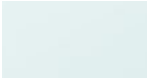





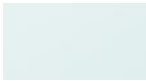

220

L. 220 P. 90 H. 73; Struttura P.L. 10 Kg; V. 0,420 mc
W. 220 D. 90 H. 73; Structure G.W. 10 Kg; V. 0,420 cbm

Codice Code	Colore Color	Prezzo Retail con Iva Retail price with Vat	Codice campione Sample code	Campionario nr. Sample box n.	Codice Code	Colore Color	Prezzo Retail con Iva Retail price with Vat	Codice campione Sample code	Campionario nr. Sample box n.
D00270I354154		5.400,00							
Piano: P.L. 51 Kg; V. 0,169 mc Top: G.W. 51 Kg; V. 0,169 cbm									
	Legno Noce Canaletto Canaletto Walnut wood			10					
D00270I355A96		4.100,00							
Piano: P.L. 100 Kg; V. 0,127 mc Top: G.W. 100 Kg; V. 0,127 cbm									
	Vetro trasparente Transparent glass		ND/NA			Vetro trasparente Transparent glass		ND/NA	
	Legno Noce Canaletto Canaletto Walnut wood		LEMNOF9601	10		Legno di Frassino Ebanizzato Ebonized Ash wood		LEMFR09601	10
D00270I359177		8.000,00							
Piano: P.L. 205 Kg; V. 0,20 mc Top: G.W. 205 Kg; V. 0,20 cbm									
	Marmo Carrara Bianco lucido White polished Carrara marble		MAR002L2	8		Marmo Marquina Nero lucido Black polished Marquina marble		MAR091L1	8
	Legno Noce Canaletto Canaletto Walnut wood		LEMNOF9601	10		Legno di Frassino Ebanizzato Ebonized Ash wood		LEMFR09601	10
D00270I729219		10.200,00							
Piano: P.L. 205 Kg; V. 0,20 mc Top: G.W. 205 Kg; V. 0,20 cbm									
	Marmo rosso Lepanto Red Lepanto marble		MAR002L2	8		Marmo rosso Lepanto Red Lepanto marble		MAR002L2	8
	Legno Noce Canaletto Canaletto Walnut wood		LEMNOF9601	10		Legno di Frassino Ebanizzato Ebonized Ash wood		LEMNOF9601	10
D00270I757225		9.700,00							
Piano: P.L. 205 Kg; V. 0,20 mc Top: G.W. 205 Kg; V. 0,20 cbm									
	Marmo verde Alpi Green Alpi marble		MAR002L2	8		Marmo verde Alpi Green Alpi marble		MAR002L2	8
	Legno Noce Canaletto Canaletto Walnut wood		LEMNOF9601	10		Legno di Frassino Ebanizzato Ebonized Ash wood		LEMNOF9601	10
D00270I784207		10.500,00							
Piano: P.L. 205 Kg; V. 0,20 mc Top: G.W. 205 Kg; V. 0,20 cbm									
	Marmo nero Galaxy Black Galaxy marble		MAR002L2	8		Marmo nero Galaxy Black Galaxy marble		MAR002L2	8
	Legno Noce Canaletto Canaletto Walnut wood		LEMNOF9601	10		Legno di Frassino Ebanizzato Ebonized Ash wood		LEMNOF9601	10
D00270I788267		10.100,00							
Piano: P.L. 205 Kg; V. 0,20 mc Top: G.W. 205 Kg; V. 0,20 cbm									
	Marmo nero Galaxy Black Galaxy marble		MAR002L2	8		Legno di Frassino Ebanizzato Ebonized Ash wood		LEMNOF9601	10

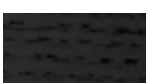

L. 240 P. 105 H. 73; Struttura P.L. 10 Kg; V. 0,420 mc
W. 240 D. 105 H. 73; Structure G.W. 10 Kg; V. 0,420 cbm

Codice Code	Colore Color	Prezzo Retail con Iva Retail price with Vat	Codice campione Sample code	Campionario nr. Sample box n.	Codice Code	Colore Color	Prezzo Retail con Iva Retail price with Vat	Codice campione Sample code	Campionario nr. Sample box n.
D002711354154		5.800,00							
Piano: P.L. 58 Kg; V. 0,198 mc Top: G.W. 58 Kg; V. 0,198 cbm									
	Legno Noce Canaletto Canaletto Walnut wood			10					
D002711355A96		4.750,00							
Piano: P.L. 127 Kg; V. 0,149 mc Top: G.W. 127 Kg; V. 0,149 cbm									
	Vetro trasparente Transparent glass		ND/NA						
	Legno Noce Canaletto Canaletto Walnut wood		LEMNOF96O1	10					
D002711359177		8.800,00							
Piano: P.L. 220 Kg; V. 0,21 mc Top: G.W. 220 Kg; V. 0,21 cbm									
	Marmo Carrara Bianco lucido White polished Carrara marble		MAR002L2	8					
	Legno Noce Canaletto Canaletto Walnut wood		LEMNOF96O1	10					
D002711729219		11.300,00							
Piano: P.L. 220 Kg; V. 0,21 mc Top: G.W. 220 Kg; V. 0,21 cbm									
	Marmo rosso Lepanto Red Lepanto marble		MAR002L2	8					
	Legno Noce Canaletto Canaletto Walnut wood		LEMNOF96O1	10					
D002711757225		10.500,00							
Piano: P.L. 220 Kg; V. 0,21 mc Top: G.W. 220 Kg; V. 0,21 cbm									
	Marmo verde Alpi Green Alpi marble		MAR002L2	8					
	Legno Noce Canaletto Canaletto Walnut wood		LEMNOF96O1	10					
D002711784207		11.700,00							
Piano: P.L. 220 Kg; V. 0,21 mc Top: G.W. 220 Kg; V. 0,21 cbm									
	Marmo nero Galaxy Black Galaxy marble		MAR002L2	8					
	Legno Noce Canaletto Canaletto Walnut wood		LEMNOF96O1	10					
D002711356A98		3.900,00							
Piano: P.L. 127 Kg; V. 0,149 mc Top: G.W. 127 Kg; V. 0,149 cbm									
	Vetro trasparente Transparent glass		ND/NA						
	Legno di Frassino Ebanizzato Ebonized Ash wood		LEMFR096O1	10					
D002711360267		6.350,00							
Piano: P.L. 220 Kg; V. 0,21 mc Top: G.W. 220 Kg; V. 0,21 cbm									
	Marmo Marquina Nero lucido Black polished Marquina marble		MAR091L1	8					
	Legno di Frassino Ebanizzato Ebonized Ash wood		LEMFR096O1	10					
D002711734280		10.900,00							
Piano: P.L. 220 Kg; V. 0,21 mc Top: G.W. 220 Kg; V. 0,21 cbm									
	Marmo rosso Lepanto Red Lepanto marble		MAR002L2	8					
	Legno di Frassino Ebanizzato Ebonized Ash wood		LEMNOF96O1	10					
D002711761287		10.200,00							
Piano: P.L. 220 Kg; V. 0,21 mc Top: G.W. 220 Kg; V. 0,21 cbm									
	Marmo verde Alpi Green Alpi marble		MAR002L2	8					
	Legno di Frassino Ebanizzato Ebonized Ash wood		LEMNOF96O1	10					
D002711788267		11.350,00							
Piano: P.L. 220 Kg; V. 0,21 mc Top: G.W. 220 Kg; V. 0,21 cbm									
	Marmo nero Galaxy Black Galaxy marble		MAR002L2	8					
	Legno di Frassino Ebanizzato Ebonized Ash wood		LEMNOF96O1	10					

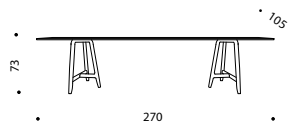

L. 270 P. 105 H. 73; Struttura P.L. 10 Kg; V. 0,420 mc
W. 270 D. 105 H. 73; Structure G.W. 10 Kg; V. 0,420 cbm

Codice Code	Colore Color	Prezzo Retail con Iva Retail price with Vat	Codice campione Sample code	Campionario nr. Sample box n.	Codice Code	Colore Color	Prezzo Retail con Iva Retail price with Vat	Codice campione Sample code	Campionario nr. Sample box n.
D002721354154	Legno Noce Canaletto Canaletto Walnut wood	6.250,00		10	D002721356A98	Vetro trasparente Transparent glass	4.700,00	ND/NA	
Piano: P.L. 62 Kg; V. 0,238 mc Top: G.W. 62 Kg; V. 0,238 cbm					Piano: P.L. 164 Kg; V. 0,238 mc Top: G.W. 164 Kg; V. 0,238 cbm				
D002721355A96	Vetro trasparente Transparent glass	5.500,00	ND/NA		D002721360267	Legno di Frassino Ebanizzato Ebonized Ash wood	6.800,00	LEMFR09601	10
Piano: P.L. 164 Kg; V. 0,238 mc Top: G.W. 164 Kg; V. 0,238 cbm					Piano: P.L. 240 Kg; V. 0,22 mc Top: G.W. 240 Kg; V. 0,22 cbm				
D002721359177	Legno Noce Canaletto Canaletto Walnut wood	9.700,00	LEMNOF9601	10	D002721734280	Marmo Carrara Bianco lucido White polished Carrara marble	11.250,00	MAR091L1	8
Piano: P.L. 240 Kg; V. 0,22 mc Top: G.W. 240 Kg; V. 0,22 cbm					Piano: P.L. 240 Kg; V. 0,22 mc Top: G.W. 240 Kg; V. 0,22 cbm				
D002721729219	Marmo Carrara Bianco lucido White polished Carrara marble	11.600,00	MAR002L2	8	D002721761287	Legno di Frassino Ebanizzato Ebonized Ash wood	10.500,00	LEMNOF9601	10
Piano: P.L. 240 Kg; V. 0,22 mc Top: G.W. 240 Kg; V. 0,22 cbm					Piano: P.L. 240 Kg; V. 0,22 mc Top: G.W. 240 Kg; V. 0,22 cbm				
D002721757225	Legno Noce Canaletto Canaletto Walnut wood	10.900,00	LEMNOF9601	10	D002721788267	Marmo rosso Lepanto Red Lepanto marble	11.600,00	MAR002L2	8
Piano: P.L. 240 Kg; V. 0,22 mc Top: G.W. 240 Kg; V. 0,22 cbm					Piano: P.L. 240 Kg; V. 0,22 mc Top: G.W. 240 Kg; V. 0,22 cbm				
D002721784207	Marmo rosso Lepanto Red Lepanto marble	11.900,00	MAR002L2	8	D002721784207	Marmo verde Alpi Green Alpi marble		MAR002L2	8
Piano: P.L. 240 Kg; V. 0,22 mc Top: G.W. 240 Kg; V. 0,22 cbm					Piano: P.L. 240 Kg; V. 0,22 mc Top: G.W. 240 Kg; V. 0,22 cbm				
D002721784207	Legno Noce Canaletto Canaletto Walnut wood		LEMNOF9601	10	D002721784207	Legno di Frassino Ebanizzato Ebonized Ash wood		LEMNOF9601	10
Piano: P.L. 240 Kg; V. 0,22 mc Top: G.W. 240 Kg; V. 0,22 cbm					Piano: P.L. 240 Kg; V. 0,22 mc Top: G.W. 240 Kg; V. 0,22 cbm				
D002721784207	Marmo verde Alpi Green Alpi marble		MAR002L2	8	D002721784207	Marmo nero Galaxy Black Galaxy marble		MAR002L2	8
Piano: P.L. 240 Kg; V. 0,22 mc Top: G.W. 240 Kg; V. 0,22 cbm					Piano: P.L. 240 Kg; V. 0,22 mc Top: G.W. 240 Kg; V. 0,22 cbm				
D002721784207	Legno Noce Canaletto Canaletto Walnut wood		LEMNOF9601	10	D002721784207	Legno di Frassino Ebanizzato Ebonized Ash wood		LEMNOF9601	10
Piano: P.L. 240 Kg; V. 0,22 mc Top: G.W. 240 Kg; V. 0,22 cbm					Piano: P.L. 240 Kg; V. 0,22 mc Top: G.W. 240 Kg; V. 0,22 cbm				

FOURDROPS

by Gabriele e Oscar
Buratti
2018

Tavolo

Tavoli con struttura in tubolare metallico. Piani in particelle di legno rivestito con doppio tranciato di legno di olmo o frassino tinto nero, bordo sagomato in legno massello di olmo o frassino tinto nero, verniciatura trasparente all'acqua. Piani in cristallo spessore 15 mm. extrachiaro a filo lucido temperato retrolaccato nella gamma dei colori Valcucine. Piani in marmo bianco Carrara, nero Marquina, rosso Lepanto, verde Alpi o nero Galaxy. 4 gambe in legno massello con sezione a forma di goccia, nelle essenze di olmo, per piano in legno di olmo o frassino tinto nero per piani in marmo, in vetro e in legno di frassino tinto nero. Uso solo interno.

Table

Tables with a tubular metal structure. Tops in particleboard covered with double veneer of elm wood or black lacquered ash, shaped edge in solid elm or black lacquered ash, transparent water-based paint. Tops in 15 mm thick extra-clear tempered-back lacquered glass in the Valcucine color range. Tops in white Carrara, black Marquina, red Lepanto, green Alpi or black Galaxy marble. Four legs in solid wood with a drop-shaped section, in elm veneer, for top in elm wood, or in black lacquered ash, for top in marble, in glass and in black lacquered ash wood. Indoor use only.

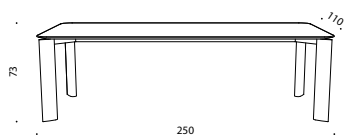

L. 250 P. 110 H. 73
W. 250 D. 110 H. 73

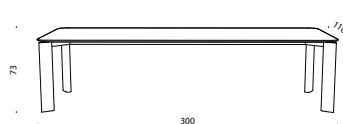











L. 300 P. 110 H. 73
W. 300 D. 110 H. 73

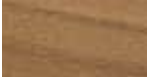
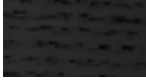
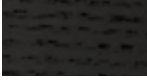

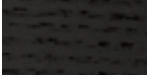
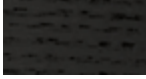
ø 160 H. 73
ø 160 H. 73

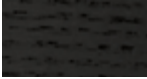
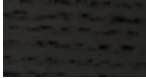

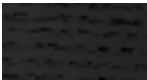



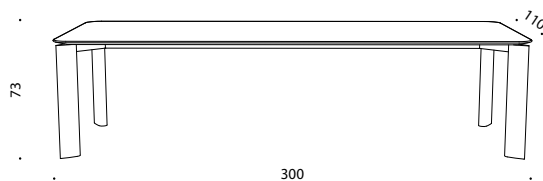



L. 250 P. 110 H. 73
 W. 250 D. 110 H. 73
 Struttura: P.L. 25 Kg; V. 0,12 mc
 Structure G.W. 25 Kg; V. 0,12 cbm
 Gambe: P.L. 10 Kg; V. 0,29 mc
 Legs: G.W. 10 Kg; V. 0,29 cbm

Codice Code	Colore Color	Prezzo Retail con Iva Retail price with Vat	Codice campione Sample code	Campionario nr. Sample box n.	Codice Code	Colore Color	Prezzo Retail con Iva Retail price with Vat	Codice campione Sample code	Campionario nr. Sample box n.
D310311422154		7.800,00			D310311734280		11.100,00		
Piano: P.L. 55 Kg; V. 2,88 mc Top: G.W. 55 Kg; V. 2,88 cbm					Piano: P.L. 200 Kg; V. 0,53 mc Top: G.W. 200 Kg; V. 0,53 cbm				
	Legno di Olmo Elm wood		LEMOL15401	10		Marmo rosso Lepanto Red Lepanto marble		ND/NA	8
	Legno di Olmo Elm wood		LEMOL15401	10		Legno di Frassino ebanizzato Ebonized Ash wood		LEMFR09601	10
D310311423096		7.800,00			D310311761287		10.200,00		
Piano: P.L. 55 Kg; V. 2,88 mc Top: G.W. 55 Kg; V. 2,88 cbm					Piano: P.L. 200 Kg; V. 0,53 mc Top: G.W. 200 Kg; V. 0,53 cbm				
	Legno di Frassino ebanizzato Ebonized Ash wood		LEMFR09601	10		Marmo verde Alpi Green Alpi marble		ND/NA	8
	Legno di Frassino ebanizzato Ebonized Ash wood		LEMFR09601	10		Legno di Frassino ebanizzato Ebonized Ash wood		LEMFR09601	10
D310311362067		8.600,00			D310311788267		11.300,00		
Piano: P.L. 200 Kg; V. 0,53 mc Top: G.W. 200 Kg; V. 0,53 cbm					Piano: P.L. 200 Kg; V. 0,53 mc Top: G.W. 200 Kg; V. 0,53 cbm				
	Marmo Marquina Nero lucido Black polished Marquina marble		MAR091L1	8		Marmo nero Galaxy Black Galaxy marble		ND/NA	8
	Legno di Frassino ebanizzato Ebonized Ash wood		LEMFR09601	10		Legno di Frassino ebanizzato Ebonized Ash wood		LEMFR09601	10
D310311364230		9.700,00			D310311356		5.450,00		
Piano: P.L. 200 Kg; V. 0,53 mc Top: G.W. 200 Kg; V. 0,53 cbm					Piano: P.L. 130 Kg; V. 2,88 mc Top: G.W. 130 Kg; V. 2,88 cbm				
	Marmo Carrara Bianco lucido White polished Carrara marble		MAR002L2	8		Tabella vetri / Table of glasses Libro "abbinamento tessuti-pelli/materiali" Book "matching fabrics-leathers/materials"			9
	Legno di Frassino ebanizzato Ebonized Ash wood		LEMFR09601	10		Legno di Frassino ebanizzato Ebonized Ash wood		LEMFR09601	10

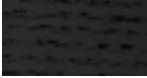

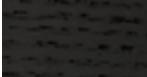
L. 300 P. 110 H. 73
 W. 300 D. 110 H. 73
 Struttura: P.L. 30 Kg; V. 0,15 mc
 Structure G.W. 30 Kg; V. 0,15 cbm
 Gambe: P.L. 10 Kg; V. 0,29 mc
 Legs: G.W. 10 Kg; V. 0,29 cbm

Codice Code	Colore Color	Prezzo Retail con Iva Retail price with Vat	Codice campione Sample code	Campionario nr. Sample box n.	Codice Code	Colore Color	Prezzo Retail con Iva Retail price with Vat	Codice campione Sample code	Campionario nr. Sample box n.
D311331422154		8.750,00			D311331356		6.180,00		
Piano: P.L. 65 Kg; V. 3,43 mc Top: G.W. 65 Kg; V. 3,43 cbm					Piano: P.L. 150 Kg; V. 3,43 mc Top: G.W. 150 Kg; V. 3,43 cbm				
	Legno di Olmo Elm wood		LEMOL15401	10		Tabella vetri/ Table of glasses Libro "abbinamento tessuti-pelli/materiali" Book "matching fabrics-leathers/materials"			9
	Legno di Olmo Elm wood		LEMOL15401	10		Legno di Frassino ebanizzato Ebonized Ash wood		LEMFR09601	10
D311331423096		8.750,00							
Piano: P.L. 65 Kg; V. 3,43 mc Top: G.W. 65 Kg; V. 3,43 cbm									
	Legno di Frassino ebanizzato Ebonized Ash wood		LEMFR09601	10					
	Legno di Frassino ebanizzato Ebonized Ash wood		LEMFR09601	10					
D311331360267		9.200,00							
Piano: P.L. 240 Kg; V. 0,62 mc Top: G.W. 240 Kg; V. 0,62 cbm									
	Marmo Marquina Nero lucido Black polished Marquina marble		MAR091L1	8					
	Legno di Frassino ebanizzato Ebonized Ash wood		LEMFR09601	10					
D311331364230		10.100,00							
Piano: P.L. 240 Kg; V. 0,62 mc Top: G.W. 240 Kg; V. 0,62 cbm									
	Marmo Carrara Bianco lucido White polished Carrara marble		MAR002L2	8					
	Legno di Frassino ebanizzato Ebonized Ash wood		LEMFR09601	10					

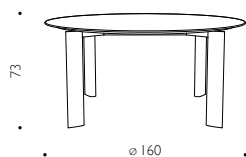

∅ 160 H. 73

∅ 160 H. 73

Struttura: P.L. 10 Kg; V. 0,049 mc

Structure G.W. 10 Kg; V. 0,049 cbm

Gambe: P.L. 10 Kg; V. 0,29 mc

Legs: G.W. 10 Kg; V. 0,29 cbm

Codice Code	Colore Color	Prezzo Retail con Iva Retail price with Vat
D31337V356		5.900,00
Piano: P.L. 110 Kg; V. 2,6 mc Top G.W. 110 Kg; V. 2,6 cbm		
	Tabella vetri/ <i>Table of glasses</i> Libro "abbinamento tessuti-pelli/materiali" Book "matching fabrics-leathers/materials"	Codice campione Sample code 9
	Legno di Frassino Ebanizzato <i>Ebonized Ash wood</i>	Campionario nr. Sample box n. 10
	LEMFR096O1	

FRANÇOIS
by Lievore Altherr
2017
Tavolo

Struttura in tubolare metallico 60x60, gambe in massello di frassino, piani in legno, vetro acidato retro laccato (gamma vetri Valcucine) e marmo. Uso solo interno.

Table

Table with structure in metal rod 60x60, legs in solid ash, top in wood, tempered glass top (Valcucine glass) and marble. Indoor use only.



Rovere/Frassino/Alluminio anodizzato
Oak/Ash/Anodized aluminum



Rovere/Frassino/Alluminio anodizzato
Oak/Ash/Anodized aluminum



Vetro acidato/Frassino/Alluminio anodizzato
Frosted glass/Ash/Anodized aluminum



Vetro acidato/Frassino/Alluminio anodizzato
Frosted glass/Ash/Anodized aluminum





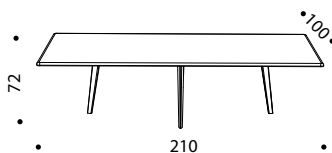





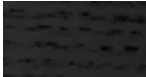

Marmo Carrara/Frassino/Alluminio anodizzato
Carrara marble/Ash/Anodized aluminum

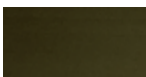







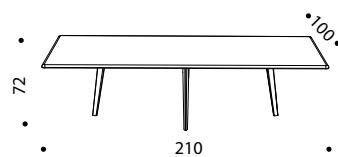



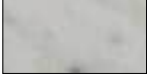

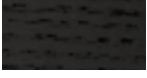

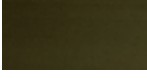

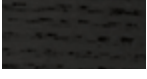
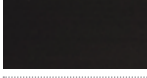
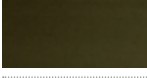

L. 210 P. 100 H. 72; W. 210 D. 100 H. 72

Struttura P.L. 38,8 Kg; V. 0,055 mc; Structure G.W. 38,8 Kg; V. 0,055 cbm

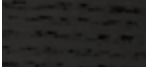
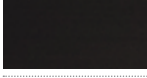
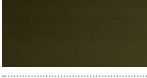
Codice Code	Colore Color	Prezzo Retail con Iva Retail price with Vat	Codice campione Sample code	Campionario nr. Sample box n.	Codice Code	Colore Color	Prezzo Retail con Iva Retail price with Vat	Codice campione Sample code	Campionario nr. Sample box n.
D02000I350B14		3.400,00			D02000I350B15		3.400,00		
Piano: P.L. 60 Kg; V. 0,183 mc Top: G.W. 60 Kg; V. 0,183 cbm					Piano: P.L. 60 Kg; V. 0,183 mc Top: G.W. 60 Kg; V. 0,183 cbm				
	Legno di Frassino tinto rovere nat. Natural oak stained ash wood		LEIRO154O1	10		Legno di Frassino tinto rovere eb. Ebonized oak stained ash wood		LEMRO096O1	10
	Legno di Frassino tinto rovere nat. Natural oak stained ash wood		LEIRO154O1	10		Legno di Frassino tinto rovere eb. Ebonized oak stained ash wood		LEMRO096O1	10
	Alluminio anodizzato Testa di moro Dark brown anodized Aluminum		MET085O1	7		Alluminio anodizzato Bronzo Bronze anodized Aluminum		MET122O1	7
D02000I349		4.850,00			D02000I349		4.850,00		
Piano: P.L. 95 Kg; V. 0,484 mc Top: G.W. 95 Kg; V. 0,484 cbm					Piano: P.L. 95 Kg; V. 0,484 mc Top: G.W. 95 Kg; V. 0,484 cbm				
	Tabella vetri/ Table of glasses Libro "abbinamento tessuti-pelli/materiali" Book "matching fabrics-leathers/materials"					Tabella vetri/ Table of glasses Libro "abbinamento tessuti-pelli/materiali" Book "matching fabrics-leathers/materials"			
	Legno di Frassino tinto rovere nat. Natural oak stained ash wood		LEIRO154O1	10		Legno di Frassino tinto rovere eb. Ebonized oak stained ash wood		LEMRO096O1	10
	Alluminio anodizzato Testa di moro Dark brown anodized Aluminum		MET085O1	7		Alluminio anodizzato Bronzo Bronze anodized Aluminum		MET122O1	7





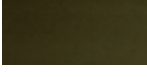

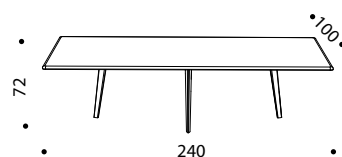







L. 210 P. 100 H. 72
W. 210 D. 100 H. 72
Struttura P.L. 38,8 Kg; V. 0,055 mc
Structure G.W. 38,8 Kg; V. 0,055 cbm

Codice Code	Colore Color	Prezzo Retail con Iva Retail price with Vat	Codice campione Sample code	Campionario nr. Sample box n.	Codice Code	Colore Color	Prezzo Retail con Iva Retail price with Vat	Codice campione Sample code	Campionario nr. Sample box n.
D02000I351H78 Piano: P.L. 168 Kg; V. 0,42 mc Top: G.W. 168 Kg; V. 0,42 cbm		6.700,00			D02000I351B16 Piano: P.L. 168 Kg; V. 0,42 mc Top: G.W. 168 Kg; V. 0,42 cbm		6.700,00		
	Marmo Carrara Bianco lucido White polished Carrara marble		MAR002L2	8		Marmo Carrara Bianco lucido White polished Carrara marble			
	Legno di Frassino tinto rovere nat. Natural oak stained ash wood		LEMFR096O1	10		Legno di Frassino tinto rovere eb. Ebonized oak stained ash wood		LEMRO096O1	10
	Alluminio anodizzato Testa di moro Dark brown anodized Aluminum		MET085O1	7		Alluminio anodizzato Bronzo Bronze anodized Aluminum		MET122O1	7
D02000I725H76 Piano: P.L. 168 Kg; V. 0,42 mc Top: G.W. 168 Kg; V. 0,42 cbm		8.500,00			D02000I725H77 Piano: P.L. 168 Kg; V. 0,42 mc Top: G.W. 168 Kg; V. 0,42 cbm		8.500,00		
	Marmo rosso Lepanto Red Lepanto marble		ND/NA	8		Marmo rosso Lepanto Red Lepanto marble			
	Legno di Frassino tinto rovere nat. Natural oak stained ash wood		LEMFR096O1	10		Legno di Frassino tinto rovere eb. Ebonized oak stained ash wood		LEMRO096O1	10
	Alluminio anodizzato Testa di moro Dark brown anodized Aluminum		MET085O1	7		Alluminio anodizzato Bronzo Bronze anodized Aluminum		MET122O1	7
D02000I752H79 Piano: P.L. 168 Kg; V. 0,42 mc Top: G.W. 168 Kg; V. 0,42 cbm		8.000,00			D02000I752H80 Piano: P.L. 168 Kg; V. 0,42 mc Top: G.W. 168 Kg; V. 0,42 cbm		8.000,00		
	Marmo verde Alpi Green Alpi marble		ND/NA	8		Marmo verde Alpi Green Alpi marble		ND/NA	
	Legno di Frassino tinto rovere nat. Natural oak stained ash wood		LEMFR096O1	10		Legno di Frassino tinto rovere eb. Ebonized oak stained ash wood		LEMRO096O1	10
	Alluminio anodizzato Testa di moro Dark brown anodized Aluminum		MET085O1	7		Alluminio anodizzato Bronzo Bronze anodized Aluminum		MET122O1	7
D02000I780H81 Piano: P.L. 168 Kg; V. 0,42 mc Top: G.W. 168 Kg; V. 0,42 cbm		8.750,00			D02000I780H82 Piano: P.L. 168 Kg; V. 0,42 mc Top: G.W. 168 Kg; V. 0,42 cbm		8.750,00		
	Marmo nero Galaxy Black Galaxy marble		ND/NA	8		Marmo nero Galaxy Black Galaxy marble		ND/NA	
	Legno di Frassino tinto rovere nat. Natural oak stained ash wood		LEMFR096O1	10		Legno di Frassino tinto rovere eb. Ebonized oak stained ash wood		LEMRO096O1	10
	Alluminio anodizzato Testa di moro Dark brown anodized Aluminum		MET085O1	7		Alluminio anodizzato Bronzo Bronze anodized Aluminum		MET122O1	7







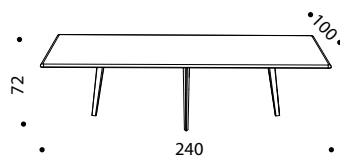



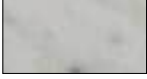

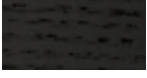

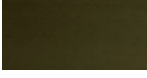



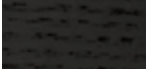
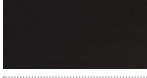
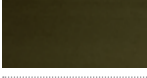

L. 240 P. 100 H. 72
 W. 240 D. 100 H. 72
 Struttura P.L. 22 Kg; V. 0,099 mc
 Structure G.W. 22 Kg; V. 0,099 cbm

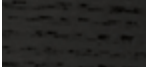
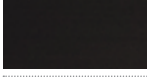
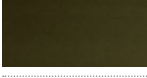
Codice Code	Colore Color	Prezzo Retail con Iva Retail price with Vat	Codice campione Sample code	Campionario nr. Sample box n.	Codice Code	Colore Color	Prezzo Retail con Iva Retail price with Vat	Codice campione Sample code	Campionario nr. Sample box n.
D020011350B14		3.850,00			D020011350B15		3.850,00		
Piano: P.L. 70 Kg; V. 0,208 mc Top: G.W. 70 Kg; V. 0,208 cbm					Piano: P.L. 70 Kg; V. 0,208 mc Top: G.W. 70 Kg; V. 0,208 cbm				
	Legno di Frassino tinto rovere nat. Natural oak stained ash wood		LEIRO154O1	10		Legno di Frassino tinto rovere eb. Ebonized oak stained ash wood		LEIRO154O1	10
	Legno di Frassino tinto rovere nat. Natural oak stained ash wood		LEIRO154O1	10		Legno di Frassino tinto rovere eb. Ebonized oak stained ash wood		LEMRO096O1	10
	Alluminio anodizzato Testa di moro Dark brown anodized Aluminum		MET085O1	7		Alluminio anodizzato Bronzo Bronze anodized Aluminum		MET122O1	7
D020011349		5.390,00			D020011349		5.390,00		
Piano: P.L. 106 Kg; V. 0,55 mc Top: G.W. 106 Kg; V. 0,55 cbm					Piano: P.L. 106 Kg; V. 0,55 mc Top: G.W. 106 Kg; V. 0,55 cbm				
	Tabella vetri/ Table of glasses Libro "abbinamento tessuti-pelli/materiali" Book "matching fabrics-leathers/materials"					Tabella vetri/ Table of glasses Libro "abbinamento tessuti-pelli/materiali" Book "matching fabrics-leathers/materials"			
	Legno di Frassino tinto rovere nat. Natural oak stained ash wood		LEIRO154O1	10		Legno di Frassino tinto rovere eb. Ebonized oak stained ash wood		LEMRO096O1	10
	Alluminio anodizzato Testa di moro Dark brown anodized Aluminum		MET085O1	7		Alluminio anodizzato Bronzo Bronze anodized Aluminum		MET122O1	7





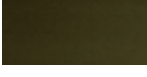

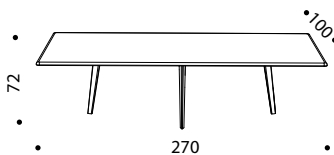



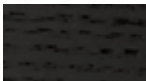

L. 240 P. 100 H. 72
W. 240 D. 100 H. 72
Struttura P.L. 22 Kg; V. 0,099 mc
Structure G.W. 22 Kg; V. 0,099 cbm

Codice Code	Colore Color	Prezzo Retail con Iva Retail price with Vat	Codice campione Sample code	Campionario nr. Sample box n.	Codice Code	Colore Color	Prezzo Retail con Iva Retail price with Vat	Codice campione Sample code	Campionario nr. Sample box n.
D020011351H78		7.000,00			D020011351B16		7.000,00		
Piano: P.L. 185 Kg; V. 0,48 mc Top: G.W. 185 Kg; V. 0,48 cbm					Piano: P.L. 185 Kg; V. 0,48 mc Top: G.W. 185 Kg; V. 0,48 cbm				
	Marmo Carrara Bianco lucido White polished Carrara marble		MAR002L2	8		Marmo Carrara Bianco lucido White polished Carrara marble			
	Legno di Frassino tinto rovere nat. Natural oak stained ash wood		LEMFR096O1	10		Legno di Frassino tinto rovere eb. Ebonized oak stained ash wood		LEMRO096O1	10
	Alluminio anodizzato Testa di moro Dark brown anodized Aluminum		MET085O1	7		Alluminio anodizzato Bronzo Bronze anodized Aluminum		MET122O1	7
D020011725H76		9.000,00			D020011725H77		9.000,00		
Piano: P.L. 185 Kg; V. 0,48 mc Top: G.W. 185 Kg; V. 0,48 cbm					Piano: P.L. 185 Kg; V. 0,48 mc Top: G.W. 185 Kg; V. 0,48 cbm				
	Marmo rosso Lepanto Red Lepanto marble		ND/NA	8		Marmo rosso Lepanto Red Lepanto marble			
	Legno di Frassino tinto rovere nat. Natural oak stained ash wood		LEMFR096O1	10		Legno di Frassino tinto rovere eb. Ebonized oak stained ash wood		LEMRO096O1	10
	Alluminio anodizzato Testa di moro Dark brown anodized Aluminum		MET085O1	7		Alluminio anodizzato Bronzo Bronze anodized Aluminum		MET122O1	7
D020011752H79		8.300,00			D020011752H80		8.300,00		
Piano: P.L. 185 Kg; V. 0,48 mc Top: G.W. 185 Kg; V. 0,48 cbm					Piano: P.L. 185 Kg; V. 0,48 mc Top: G.W. 185 Kg; V. 0,48 cbm				
	Marmo verde Alpi Green Alpi marble		ND/NA	8		Marmo verde Alpi Green Alpi marble		ND/NA	
	Legno di Frassino tinto rovere nat. Natural oak stained ash wood		LEMFR096O1	10		Legno di Frassino tinto rovere eb. Ebonized oak stained ash wood		LEMRO096O1	10
	Alluminio anodizzato Testa di moro Dark brown anodized Aluminum		MET085O1	7		Alluminio anodizzato Bronzo Bronze anodized Aluminum		MET122O1	7
D020011780H81		9.300,00			D020011780H82		9.300,00		
Piano: P.L. 185 Kg; V. 0,48 mc Top: G.W. 185 Kg; V. 0,48 cbm					Piano: P.L. 185 Kg; V. 0,48 mc Top: G.W. 185 Kg; V. 0,48 cbm				
	Marmo nero Galaxy Black Galaxy marble		ND/NA	8		Marmo nero Galaxy Black Galaxy marble		ND/NA	
	Legno di Frassino tinto rovere nat. Natural oak stained ash wood		LEMFR096O1	10		Legno di Frassino tinto rovere eb. Ebonized oak stained ash wood		LEMRO096O1	10
	Alluminio anodizzato Testa di moro Dark brown anodized Aluminum		MET085O1	7		Alluminio anodizzato Bronzo Bronze anodized Aluminum		MET122O1	7



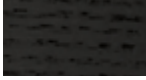

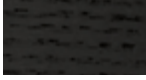

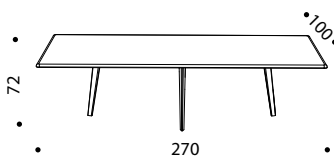





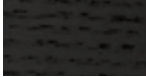

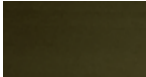





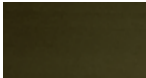

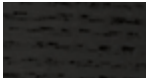

L. 270 P. 100 H. 72
 W. 270 D. 100 H. 72
 Struttura P.L. 40 Kg; V. 0,086 mc
 Structure G.W. 40 Kg; V. 0,08 cbm

Codice Code	Colore Color	Prezzo Retail con Iva Retail price with Vat	Codice campione Sample code	Campionario nr. Sample box n.	Codice Code	Colore Color	Prezzo Retail con Iva Retail price with Vat	Codice campione Sample code	Campionario nr. Sample box n.
D02002I350B14		4.150,00			D02002I350B15		4.150,00		
Piano: P.L. 80 Kg; V. 0,234 mc Top: G.W. 80 Kg; V. 0,234 cbm					Piano: P.L. 80 Kg; V. 0,234 mc Top: G.W. 80 Kg; V. 0,234 cbm				
	Legno di Frassino tinto rovere nat. Natural oak stained ash wood		LEIRO154O1	10		Legno di Frassino tinto rovere eb. Ebonized oak stained ash wood		LEMRO096O1	10
	Legno di Frassino tinto rovere nat. Natural oak stained ash wood		LEIRO154O1	10		Legno di Frassino tinto rovere eb. Ebonized oak stained ash wood		LEMRO096O1	10
	Alluminio anodizzato Testa di moro Dark brown anodized Aluminum		MET085O1	7		Alluminio anodizzato Bronzo Bronze anodized Aluminum		MET122O1	7
D02002I349 Piano: P.L. 130 Kg; V. 0,672 mc Top: G.W. 130 Kg; V. 0,672 cbm					D02002I349 Piano: P.L. 130 Kg; V. 0,672 mc Top: G.W. 130 Kg; V. 0,672 cbm				
	Tabella vetri/ Table of glasses Libro "abbinamento tessuti-pelli/materiali" Book "matching fabrics-leathers/materials"					Tabella vetri/ Table of glasses Libro "abbinamento tessuti-pelli/materiali" Book "matching fabrics-leathers/materials"			
	Legno di Frassino tinto rovere nat. Natural oak stained ash wood		LEIRO154O1	10		Legno di Frassino tinto rovere eb. Ebonized oak stained ash wood		LEMRO096O1	10
	Alluminio anodizzato Testa di moro Dark brown anodized Aluminum		MET085O1	7		Alluminio anodizzato Bronzo Bronze anodized Aluminum		MET122O1	7

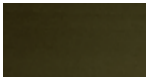

L. 270 P. 100 H. 72
W. 270 D. 100 H. 72
Struttura P.L. 40 Kg; V. 0,086 mc
Structure G.W. 40 Kg; V. 0,08 cbm

Codice Code	Colore Color	Prezzo Retail con Iva Retail price with Vat	Codice campione Sample code	Campionario nr. Sample box n.	Codice Code	Colore Color	Prezzo Retail con Iva Retail price with Vat	Codice campione Sample code	Campionario nr. Sample box n.
D02002I351H78		7.700,00			D02002I351B16		7.700,00		
Piano: P.L. 270 Kg; V. 0,54 mc Top: G.W. 270 Kg; V. 0,54 cbm					Piano: P.L. 270 Kg; V. 0,54 mc Top: G.W. 270 Kg; V. 0,54 cbm				
	Marmo Carrara Bianco lucido White polished Carrara marble		MAR002L2	8		Marmo Carrara Bianco lucido White polished Carrara marble			
	Legno di Frassino tinto rovere nat. Natural oak stained ash wood		LEMFR096O1	10		Legno di Frassino tinto rovere eb. Ebonized oak stained ash wood		LEMRO096O1	10
	Alluminio anodizzato Testa di moro Dark brown anodized Aluminum		MET085O1	7		Alluminio anodizzato Bronzo Bronze anodized Aluminum		MET122O1	7
D02002I725H76		9.800,00			D02002I725H77		9.800,00		
Piano: P.L. 270 Kg; V. 0,54 mc Top: G.W. 270 Kg; V. 0,54 cbm					Piano: P.L. 270 Kg; V. 0,54 mc Top: G.W. 270 Kg; V. 0,54 cbm				
	Marmo rosso Lepanto Red Lepanto marble		ND/NA	8		Marmo rosso Lepanto Red Lepanto marble			
	Legno di Frassino tinto rovere nat. Natural oak stained ash wood		LEMFR096O1	10		Legno di Frassino tinto rovere eb. Ebonized oak stained ash wood		LEMRO096O1	10
	Alluminio anodizzato Testa di moro Dark brown anodized Aluminum		MET085O1	7		Alluminio anodizzato Bronzo Bronze anodized Aluminum		MET122O1	7
D02002I752H79		9.300,00			D02002I752H80		9.300,00		
Piano: P.L. 270 Kg; V. 0,54 mc Top: G.W. 270 Kg; V. 0,54 cbm					Piano: P.L. 270 Kg; V. 0,54 mc Top: G.W. 270 Kg; V. 0,54 cbm				
	Marmo verde Alpi Green Alpi marble		ND/NA	8		Marmo verde Alpi Green Alpi marble		ND/NA	
	Legno di Frassino tinto rovere nat. Natural oak stained ash wood		LEMFR096O1	10		Legno di Frassino tinto rovere eb. Ebonized oak stained ash wood		LEMRO096O1	10
	Alluminio anodizzato Testa di moro Dark brown anodized Aluminum		MET085O1	7		Alluminio anodizzato Bronzo Bronze anodized Aluminum		MET122O1	7
D02002I780H81		10.100,00			D02002I780H82		10.100,00		
Piano: P.L. 270 Kg; V. 0,54 mc Top: G.W. 270 Kg; V. 0,54 cbm					Piano: P.L. 270 Kg; V. 0,54 mc Top: G.W. 270 Kg; V. 0,54 cbm				
	Marmo nero Galaxy Black Galaxy Marble		ND/NA	8		Marmo nero Galaxy Black Galaxy Marble		ND/NA	
	Legno di Frassino tinto rovere nat. Natural oak stained ash wood		LEMFR096O1	10		Legno di Frassino tinto rovere eb. Ebonized oak stained ash wood		LEMRO096O1	10
	Alluminio anodizzato Testa di moro Dark brown anodized Aluminum		MET085O1	7		Alluminio anodizzato Bronzo Bronze anodized Aluminum		MET122O1	7

FRATE
by Enzo Mari
2016
Tavolo

Struttura in profilati di acciaio verniciati di colore nero antracite collegati da una trave in massello di faggio, essenza di noce Canaletto, essenza di rovere fossile oppure essenza di rovere tinto nero. Piano rettangolare in vetro temperato spessore 12 mm. Uso solo interno.

Table

Structure in anthracite black painted steel sections connected by a solid beech beam, fossil oak, Canaletto walnut or black lacquered oak. Rectangular top in tempered glass 12 mm thick. Indoor use only.



L. 130 / 200 / 210 / 225 P. 80 H. 72 Trave 130 / 200
Struttura P.L. 28 / 32 Kg; V. 0,148 / 0,205 mc
W. 130 / 200 / 210 / 225 D. 80 H. 72 Beam 130 / 200
Structure G.W. 28 / 32 Kg; V. 0,148 / 0,205 cbm



L. 200/210/225/275/300 P. 80/86 H. 72 Trave 130 / 200
Struttura P.L. 28 / 32 Kg; V. 0,148 / 0,205 mc
W. 200/210/225/275/300 D. 80/86 H. 72 Beam 130 / 200
Structure G.W. 28 / 32 Kg; V. 0,148 / 0,205 cbm

Trave in faggio
Beech beam

Trave in noce Canaletto
Canaletto walnut beam

Colore
Color

Codice campione
Sample code

Campionario nr.
Sample box n.



Acciaio verniciato Nero Antracite
Anthracite Black painted steel

VER05701

7



Legno di Faggio Naturale
Natural Beech wood

LEMFA15401

10

Colore
Color

Codice campione
Sample code

Campionario nr.
Sample box n.



Acciaio verniciato Nero Antracite
Anthracite Black painted steel

VER05701

7



Legno di Noce Canaletto Naturale
Natural Canaletto Walnut wood

LEMNOF9601

10

Trave in rovere fossile
Fossil oak beam

Trave in rovere ebanizzato
Black lacquered oak beam

Colore
Color

Codice campione
Sample code

Campionario nr.
Sample box n.



Acciaio verniciato Nero Antracite
Anthracite Black painted steel

VER05701

7



Legno di Rovere fossile Naturale
Natural fossil Oak wood

LEIRF15401

10

Colore
Color

Codice campione
Sample code

Campionario nr.
Sample box n.



Acciaio verniciato Nero Antracite
Anthracite Black painted steel

VER05701

7



Legno di Rovere ebanizzato
Ebonized Oak wood

LEMRO09601

10

FRATE Tavolo L. 130 P. 80 Trave 130/ Table W. 130 D. 80 Beam 130
Piano: P.L. 46 Kg; V. 0,053 mc
Top: G.W. 46 Kg; V. 0,053 cbm



Codice Code	Versione Version	Prezzo Retail con Iva Retail price with Vat
D40968H345B08	Faggio Beech	2.800,00
D40968H346B08	Noce Walnut	2.900,00
D40968H347B08	Rovere fossile Fossil oak	3.000,00
D40968H348B11	Rovere Oak	2.900,00

FRATE Tavolo L. 200 P. 80 Trave 130/ Table W. 200 D. 80 Beam 130
Piano: P.L. 72 Kg; V. 0,079 mc
Top: G.W. 72 Kg; V. 0,079 cbm



Codice Code	Versione Version	Prezzo Retail con Iva Retail price with Vat
D40969H345B08	Faggio Beech	3.000,00
D40969H346B08	Noce Walnut	3.150,00
D40969H347B08	Rovere fossile Fossil oak	3.200,00
D40969H348B11	Rovere Oak	3.150,00

FRATE Tavolo L. 210 P. 80 Trave 130/ Table W. 210 D. 80 Beam 130
Piano: P.L. 76 Kg; V. 0,083 mc
Top: G.W. 76 Kg; V. 0,083 cbm



Codice Code	Versione Version	Prezzo Retail con Iva Retail price with Vat
D40960I345B08	Faggio Beech	3.050,00
D40960I346B08	Noce Walnut	3.150,00
D40960I347B08	Rovere fossile Fossil oak	3.250,00
D40960I348B11	Rovere Oak	3.150,00

FRATE Tavolo L. 225 P. 80 Trave 130/ Table W. 225 D. 80 Beam 130
Piano: P.L. 79 Kg; V. 0,089 mc
Top: G.W. 79 Kg; V. 0,089 cbm



Codice Code	Versione Version	Prezzo Retail con Iva Retail price with Vat
D40961I345B08	Faggio Beech	3.100,00
D40961I346B08	Noce Walnut	3.200,00
D40961I347B08	Rovere fossile Fossil oak	3.250,00
D40961I348B11	Rovere Oak	3.200,00

FRATE Tavolo L. 200 P. 80 Trave 200/ Table W. 200 D. 80 Beam 200
Piano: P.L. 72 Kg; V. 0,079 mc
Top: G.W. 72 Kg; V. 0,079 cbm



Codice Code	Versione Version	Prezzo Retail con Iva Retail price with Vat
D41979H345B08	Faggio Beech	3.250,00
D41979H346B08	Noce Walnut	3.350,00
D41979H347B08	Rovere fossile Fossil oak	3.420,00
D41979H348B11	Rovere Oak	3.350,00

FRATE Tavolo L. 210 P. 80 Trave 200/ Table W. 210 D. 80 Beam 200
Piano: P.L. 76 Kg; V. 0,083 mc
Top: G.W. 76 Kg; V. 0,083 cbm



Codice Code	Versione Version	Prezzo Retail con Iva Retail price with Vat
D41970I345B08	Faggio Beech	3.300,00
D41970I346B08	Noce Walnut	3.400,00
D41970I347B08	Rovere fossile Fossil oak	3.450,00
D41970I348B11	Rovere Oak	3.400,00

FRATE Tavolo L. 225 P. 80 Trave 200/ Table W. 225 D. 80 Beam 200
Piano: P.L. 79 Kg; V. 0,089 mc
Top: G.W. 79 Kg; V. 0,089 cbm



Codice Code	Versione Version	Prezzo Retail con Iva Retail price with Vat
D41971I345B08	Faggio Beech	3.300,00
D41971I346B08	Noce Walnut	3.430,00
D41971I347B08	Rovere fossile Fossil oak	3.500,00
D41971I348B11	Rovere Oak	3.430,00

FRATE Tavolo L. 275 P. 86 Trave 200/ Table W. 275 D. 86 Beam 200
Piano: P.L. 104 Kg; V. 0,107 mc
Top: G.W. 104 Kg; V. 0,107 cbm



Codice Code	Versione Version	Prezzo Retail con Iva Retail price with Vat
D41972I345B08	Faggio Beech	3.700,00
D41972I346B08	Noce Walnut	3.800,00
D41972I347B08	Rovere fossile Fossil oak	3.850,00
D41972I348B11	Rovere Oak	3.800,00

FRATE Tavolo L. 300 P. 86 Trave 200/ Table W. 300 D. 86 Beam 200
Piano: P.L. 115 Kg; V. 0,117 mc
Top: G.W. 115 Kg; V. 0,117 cbm



Codice Code	Versione Version	Prezzo Retail con Iva Retail price with Vat
D41973I345B08	Faggio Beech	3.870,00
D41973I346B08	Noce Walnut	3.950,00
D41973I347B08	Rovere fossile Fossil oak	4.000,00
D41973I348B11	Rovere Oak	3.950,00

GAZELLE
by Park Associati
2013
Tavolo

Struttura in tubolare di acciaio verniciato in tre varianti di colore: nero, bianco e rosso. Piano in mdf spessore 40 mm. con finitura in cemento o argilla color champagne o in laminato bianco. Uso solo interno.

Table

Painted tubular steel structure, available in three different colors: black, white and red. Top available in: Mdf th.40 mm. cement and clay champagne color finishes or white laminate. Indoor use only.



L. 210 P. 90 H. 73
W. 210 D. 90 H. 73
Struttura: P.L. 33 Kg; V. 0,15 mc
Structure: G.W. 33 Kg; V. 0,15 cbm
Piano: P.L. 48 Kg; V. 0,210 mc
Top: G.W. 48 Kg; V. 0,210 cbm



L. 240 P. 80 H. 73
W. 240 D. 80 H. 73
Struttura: P.L. 37 Kg; V. 0,20 mc
Structure: G.W. 37 Kg; V. 0,20 cbm
Piano: P.L. 54 Kg; V. 0,240 mc
Top: G.W. 54 Kg; V. 0,240 cbm









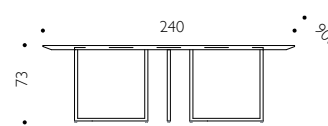
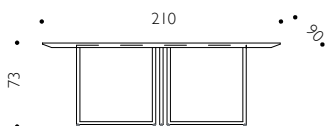

















Piani/Tops:

Colore Color	Codice campione Sample code	Campionario nr. Sample box n.
 Finitura Cemento Cement finish	ARG05701	8
 Finitura Argilla Champagne Champagne color Clay finish	ARGD4601	8
 Laminato Bianco White Laminate	LATUN00201	10

Strutture/Structures:

Colore Color	Codice campione Sample code	Campionario nr. Sample box n.
 Acciaio vern. Nero Ral 9005 opaco Matt black Ral 9005 painted Steel	VER09103	7
 Acciaio vern. Bianco Ral 9016 opaco Matt White Ral 9016 painted steel	VER00203	6
 Acciaio vern. Rosso Ral 3001 Red Ral 3001 painted Steel	VER03902	6

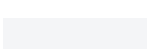
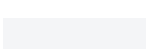
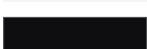
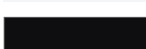
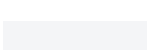
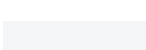
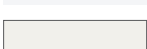
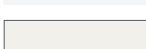
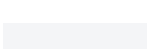
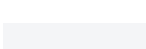

Codice Code	Versione Version	Prezzo Retail con Iva Retail price with Vat	Codice Code	Versione Version	Prezzo Retail con Iva Retail price with Vat
D00050I366625		3.950,00	D00051I366625		4.100,00
	Finitura Cemento Cement finish			Finitura Cemento Cement finish	
	Acciaio vern. Nero Ral 9005 opaco Matt black Ral 9005 painted Steel			Acciaio vern. Nero Ral 9005 opaco Matt black Ral 9005 painted Steel	
D00050I366688		3.950,00	D00051I366688		4.100,00
	Finitura Cemento Cement finish			Finitura Cemento Cement finish	
	Acciaio vern. Bianco Ral 9016 opaco Matt White Ral 9016 painted steel			Acciaio vern. Bianco Ral 9016 opaco Matt White Ral 9016 painted steel	
D00050I366B28		3.950,00	D00051I366B28		4.100,00
	Finitura Cemento Cement finish			Finitura Cemento Cement finish	
	Acciaio vern. Rosso Ral 3001 Red Ral 3001 painted Steel			Acciaio vern. Rosso Ral 3001 Red Ral 3001 painted Steel	
D00050I367B30		3.650,00	D00051I367B30		3.900,00
	Finitura Argilla Champagne Champagne color Clay finish			Finitura Argilla Champagne Champagne color Clay finish	
	Acciaio vern. Nero Ral 9005 opaco Matt black Ral 9005 painted Steel			Acciaio vern. Nero Ral 9005 opaco Matt black Ral 9005 painted Steel	
D00050I367B31		3.650,00	D00051I367B31		3.900,00
	Finitura Argilla Champagne Champagne color Clay finish			Finitura Argilla Champagne Champagne color Clay finish	
	Acciaio vern. Bianco Ral 9016 opaco Matt White Ral 9016 painted steel			Acciaio vern. Bianco Ral 9016 opaco Matt White Ral 9016 painted steel	
D00050I367B32		3.650,00	D00051I367B32		3.900,00
	Finitura Argilla Champagne Champagne color Clay finish			Finitura Argilla Champagne Champagne color Clay finish	
	Acciaio vern. Rosso Ral 3001 Red Ral 3001 painted Steel			Acciaio vern. Rosso Ral 3001 Red Ral 3001 painted Steel	
D00050I368596		3.290,00	D00051I368596		3.580,00
	Laminato Bianco White Laminate			Laminato Bianco White Laminate	
	Acciaio vern. Nero Ral 9005 opaco Matt black Ral 9005 painted Steel			Acciaio vern. Nero Ral 9005 opaco Matt black Ral 9005 painted Steel	
D00050I368669		3.290,00	D00051I368669		3.580,00
	Laminato Bianco White Laminate			Laminato Bianco White Laminate	
	Acciaio vern. Bianco Ral 9016 opaco Matt White Ral 9016 painted steel			Acciaio vern. Bianco Ral 9016 opaco Matt White Ral 9016 painted steel	
D00050I368B33		3.290,00	D00051I368B33		3.580,00
	Laminato Bianco White Laminate			Laminato Bianco White Laminate	
	Acciaio vern. Rosso Ral 3001 Red Ral 3001 painted Steel			Acciaio vern. Rosso Ral 3001 Red Ral 3001 painted Steel	

PORTABLE ATELIER

 by Philippe Nigro
2022



Scrivania

Scrivania costituita da una struttura a quattro gambe in lamiera pressopiegata verniciata a polvere poliestere nel colore nero opaco ed un piano in particelle di fibra di legno verniciato nei colori bianco o nero con finitura opaca. Una parte del piano può essere aperta a "ribalta" per avere accesso ad un "vasca" di contenimento predisposta con asole per il passaggio delle prese elettriche e dei cavi di connessione al pc. Traversi di collegamento delle gambe in faggio laccato nei colori bianco o nero in abbinamento al piano. Uso solo interno.

Desk

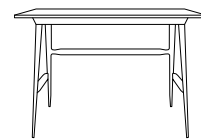
Desk with a four-leg frame made of press-bent sheet metal painted with polyester powder in matt black and a top made of wood fibre particles painted in white or black with a matt finish. One part of the top can be opened "flip" to gain access to a storage "basin" prepared with slots for the passage of electrical sockets and PC connection cables. Leg connecting crosspieces in beech lacquered in white or black to match the top. Indoor use only.

 L. 110 P. 61 H. 74,5; P.L. 35 Kg.
W. 110 D. 61 H. 74,5; G.W. 35 Kg.

Modello Model	Codice Code	Categoria materiale - Descrizione materiale Material category - Material description	Prezzo Retail con Iva Retail price with Vat
	D00018H519093	MDF laccato/Acciaio verniciato nero Lacquered MDF/ Black epainted steel	1.550,00
	D00028I358002	Kit scrivania acciaio verniciato bianco White painted Steel desk kit	135,00
	D00018H519632	MDF laccato/Acciaio verniciato nero Lacquered MDF/ Black painted steel	1.550,00
	D00028I358091	Kit scrivania acciaio verniciato nero Black painted Steel desk kit	135,00

**PORTABLE ATELIER
COLLECTION**

 by Philippe Nigro
2016

Mensola

Mensola per scrivania. Piano in multistrato di betulla impiallacciato in rovere. Elementi laterali in lamiera di acciaio verniciato nei colori bianco o nero. Elemento scorrevole di colore bianco, nero, giallo fluo o arancione fluo.

Shelf

Kit for desk in painted steel sheet composed of two lateral elements and a sliding one. Sliding element in white, black, fluorescent yellow or fluorescent orange.

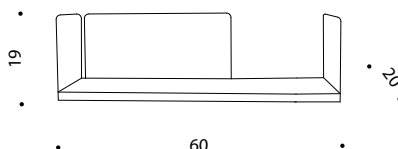
 L. 60 P. 20 H. 19
 W. 60 D. 20 H. 19
 P.L. 3,65 Kg; V. 0,003 mc
 G.W. 3,65 Kg; V. 0,003 cbm

Codice Code	Colore Color	Prezzo Retail con Iva Retail price with Vat
-------------	--------------	--

D00109I438B21

215,00

Codice campione Sample code	Campionario nr. Sample box n.
--------------------------------	----------------------------------

 Impiallacciato rovere
Oak veneered

LEIRO15401

10

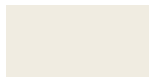
 Acciaio verniciato Bianco Ral 9010 opaco
Matt White Ral 9010 painted Steel

VER00206

6



Codice Code	Colore Color	Prezzo Retail con Iva Retail price with Vat
-------------	--------------	--

D00109I438B20

215,00

Codice campione Sample code	Campionario nr. Sample box n.
--------------------------------	----------------------------------

 Impiallacciato rovere
Oak veneered

LEIRO15401

10

 Acciaio verniciato Nero Ral 9005 opaco
Matt Black Ral 9005 painted Steel

VER09103

7



Codice Code	Colore Color	Prezzo Retail con Iva Retail price with Vat
-------------	--------------	--

54,00

Codice campione Sample code	Campionario nr. Sample box n.
--------------------------------	----------------------------------

D00210K358002

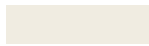
 Acciaio vern. Bianco Ral 9010 opaco
Matt White Ral 9010 painted Steel

VER00206

6

D00210K358091

 Acciaio verniciato Nero Ral 9005 opaco
Matt Black Ral 9005 painted Steel

VER09103

7



Codice Code	Colore Color	Prezzo Retail con Iva Retail price with Vat
-------------	--------------	--

54,00

Codice campione Sample code	Campionario nr. Sample box n.
--------------------------------	----------------------------------

D00210K358022

 Acciaio vern. Giallo fluo escente
Fluorescent Yellow painted Steel

VER02201

7

D00210K358034

 Acciaio verniciato Arancione flu .
Fluorescent Orange painted Steel

VER03401

7

**PORTABLE ATELIER
COLLECTION**

 by Philippe Nigro
2016

Portapenne

Elemento in lamiera di acciaio verniciato nei colori bianco, nero, giallo fluo o arancione fluo con fondo in multistrato di betulla impiallacciato rovere.

Penholder

Element in birch plywood with oak finish and steel sheet white, black, fluorescent yellow or fluorescent orange painted.

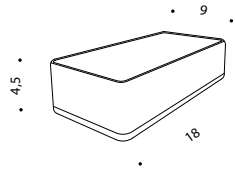
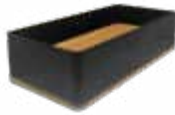
 L. 18 P. 9 H. 4,5
 W. 18 D. 9 H. 4,5
 P.L. 0,5 Kg; V. 0,010 mc
 G.W. 0,5 Kg; V. 0,010 cbm

Codice Code	Colore Color	Prezzo Retail con Iva Retail price with Vat	Codice campione Sample code	Campionario nr. Sample box n.	Codice Code	Colore Color	Prezzo Retail con Iva Retail price with Vat	Codice campione Sample code	Campionario nr. Sample box n.
		100,00					100,00		
D00290J438B21	Acciaio vern. Bianco Ral 9010 opaco Matt White Ral 9010 painted Steel		VER002O6	6	D00290J438B22	Acciaio vern. Bianco Ral 9010 opaco Matt White Ral 9010 painted Steel		VER002O6	7
	Impiallacciato rovere Oak veneered		LEIRO154O1	10		Impiallacciato rovere Oak veneered		LEIRO154O1	10
D00290J438B20	Acciaio verniciato Nero Ral 9005 opaco Matt Black Ral 9005 painted Steel	100,00	VER091O3	7	D00290J438B23	Acciaio verniciato Nero Ral 9005 opaco Matt Black Ral 9005 painted Steel	100,00	VER091O3	7
	Impiallacciato rovere Oak veneered		LEIRO154O1	10		Impiallacciato rovere Oak veneered		LEIRO154O1	10

**PORTABLE ATELIER
COLLECTION**

 by Philippe Nigro
2016

Scatola

Cassetto in multistrato di betulla impiallacciato rovere e lamiera di acciaio verniciata di colore nero, sistema di apertura a rotazione.

Box

Drawer in birch plywood with oak finish and external sheet steel black painted.

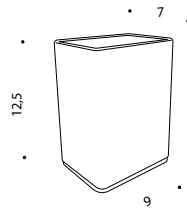
 L. 9 P. 7 H. 12,5
 W. 9 D. 7 H. 12,5
 P.L. 0,55 Kg; V. 0,010 mc
 G.W. 0,55 Kg; V. 0,010 cbm

Codice Code	Colore Color	Prezzo Retail con Iva Retail price with Vat	Codice campione Sample code	Campionario nr. Sample box n.	Codice Code	Colore Color	Prezzo Retail con Iva Retail price with Vat	Codice campione Sample code	Campionario nr. Sample box n.
		120,00					120,00		
D00410J438B21	Acciaio vern. Bianco Ral 9010 opaco Matt White Ral 9010 painted Steel		VER002O6	6	D00410J438B22	Acciaio vern. Bianco Ral 9010 opaco Matt White Ral 9010 painted Steel		VER002O6	7
	Impiallacciato rovere Oak veneered		LEIRO154O1	10		Impiallacciato rovere Oak veneered		LEIRO154O1	10
D00410J438B20	Acciaio verniciato Nero Ral 9005 opaco Matt Black Ral 9005 painted Steel	120,00	VER091O3	7	D00410J438B23	Acciaio verniciato Nero Ral 9005 opaco Matt Black Ral 9005 painted Steel	120,00	VER091O3	7
	Impiallacciato rovere Oak veneered		LEIRO154O1	10		Impiallacciato rovere Oak veneered		LEIRO154O1	10

**PORTABLE ATELIER
COLLECTION**

 by Philippe Nigro
2016

Scatola

Cassetto in multistrato di betulla impiallacciato rovere e lamiera di acciaio verniciata di colore nero, sistema di apertura a rotazione.

Box

Drawer in birch plywood with oak finish and external sheet steel black painted.

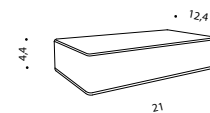
 L. 21 P. 12,4 H. 4,4; W. 21 D. 12,4 H. 4,4
P.L. 11Kg; V. 0,020 mc; G.W. 11 Kg; V. 0,020

Codice Code	Colore Color	Prezzo Retail con Iva Retail price with Vat
----------------	-----------------	--

235,00

Codice campione Sample code	Campionario nr. Sample box n.
--------------------------------	----------------------------------

D00501J438B20

 Acciaio verniciato Nero Ral 9005 opaco
Matt Black Ral 9005 painted Steel

VER09103

7

 Impiallacciato rovere
Oak veneered

LEIRO15401

10

**PORTABLE ATELIER
COLLECTION**

 by Philippe Nigro
2016

Sgabello

Sgabello con altezza regolabile. Struttura in massello di faggio tinto nero, sedile e vite di regolazione dell'altezza della seduta in massello di rovere. Uso solo interno.

Stool

Stool adjustable in heigh. Black matt painted steel structure. Seat and components in massive oak. Indoor use only.

 L. 45 ø seduta 34 H. 45/63
W. 45 ø seat 34 H. 45/63
P.L. 8 Kg; V. 0,140 mc
G.W. 8 Kg; V. 0,140 cbmcbm

Codice Code	Colore Color	Prezzo Retail con Iva Retail price with Vat
----------------	-----------------	--

710,00

Codice campione Sample code	Campionario nr. Sample box n.
--------------------------------	----------------------------------

D00045B374B20

 Legno di Rovere
Oak wood

LEIRO15401

10

 Faggio laccato nero
Black lacquered beech

LEMLA09101

10

PORTABLE ATELIER

 by Philippe Nigro
2022

Sgabello



Sgabello con seduta regolabile in altezza mediante pistone a gas con leva, struttura a tre gambe realizzata in massello di faggio tinto nero e seduta in massello di faggio laccato nei colori bianco o nero con finitura opaca. Uso solo interno.

Stool

Stool with height-adjustable seat by means of gas piston with lever, three-leg frame made of solid beech stained black and seat made of solid beech lacquered in white or black with matt finish. Indoor use only.



Dia. 45 H. 49/63; P.L. 7 Kg.
Dia 45 H. 49/63; G.W. 7 Kg.

Modello Model	Codice Code	Categoria materiale - Descrizione materiale Material category - Material description	Prezzo Retail con Iva Retail price with Vat
	D00045B520093	Faggio laccato bianco e nero Black and white lacquered beech	500,00
	D00045B520632	Faggio laccato nero Black lacquered beech	500,00

TOTTORI

 by Kateryna Sokolova
2022
Tavolo

Tavolo con piano in fibra di legno a media densità dello spessore di 30mm, bordo sagomato a "saponetta" ed angoli arrotondati. Gambe in legno massello con la parte in appoggio a terra arrotondata a semisfera e piedini di regolazione per la messa a livello del tavolo. Struttura portante in acciaio verniciata dello stesso colore dei piani, guide di scorrimento per l'apertura dei piani con profili in estruso di alluminio. Finitura laccata lucida spazzolata in tre varianti di colore.

Table

Table with top in wood fiber medium density thickness of 30mm with shaped edge to "soap" and rounded corners. Legs in solid wood with the part on the ground rounded half-sphere and adjustment feet for placing at the table. Structure in painted steel of the same color as the tops, sliding guides for opening the tops with extruded aluminum profiles. Glossy lacquered finish in three colors. Indoor use only.

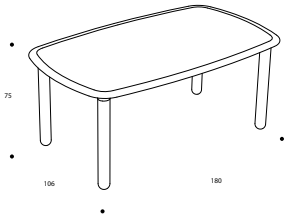

L. 180 P. 106 H. 75

Struttura e piano: P.L. 55 Kg; V. 0,342 mc; Gambe: P.L. 13 Kg; V. 0,05 mc
W. 180 D. 106 H. 75
Structure and top: G.W. 55 Kg; V. 0,342 cbm; Legs: G.W. 13 Kg; V. 0,05 cbm

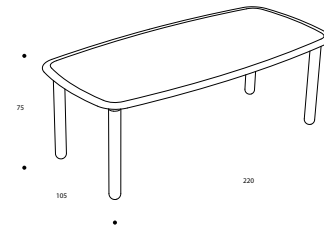

L. 220 P. 106 H. 75

Struttura e piano: P.L. 66 Kg; V. 0,396 mc; Gambe: P.L. 13 Kg; V. 0,05 mc
W. 180 D. 106 H. 75
Structure and top: G.W. 66 Kg; V. 0,396 cbm; Legs: G.W. 13 Kg; V. 0,05 cbm



Codice Code	Colore Color	Prezzo Retail con Iva Retail price with Vat	Codice Code	Colore Color	Prezzo Retail con Iva Retail price with Vat
DA5679H123G02		3.800,00	DA5670I123G02		4.150,00
	MDF bianco perla lucido Ral 1013 MDF shiny pearl white Ral 1023			MDF bianco perla lucido Ral 1013 MDF shiny pearl white Ral 1023	
DA5679H123140		3.800,00	DA5670I123140		4.150,00
	MDF rosso rubino lucido Ral 3003 MDF shiny ruby red Ral 3003			MDF rosso rubino lucido Ral 3003 MDF shiny ruby red Ral 3003	
DA5679H123092		3.800,00	DA5670I123092		4.150,00
	MDF nero lucido Ral 9005 MDF shiny black Ral 9005			MDF nero lucido Ral 9005 MDF shiny black Ral 9005	

TAVOLINI/ *COFFEE TABLES*

ANAPO
by Gordon Guillaumier
2014
Tavolini

Tavolo con base in acciaio verniciato di colore nero RAL 9005* e piano in vetro temperato spessore 15 mm. o in MDF con finitura in castagno oppure in marmo bianco Carrara. Uso solo interno.





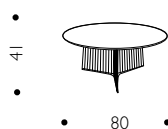







Coffee tables

Table with black RAL 9005* painted steel structure and tempered glass th.15 mm. or chestnut wooden finished or marble Carrara white top. Indoor use only.



ø 80 H. 41/ ø 80 H. 41
Struttura P.L. 6,3 Kg; V. 0,262 mc
Structure G.W. 6,3 Kg; V. 0,262 cbm



Codice Code	Colore Color	Prezzo Retail con Iva Retail price with Vat	Codice campione Sample code	Campionario nr. Sample box n.	Codice Code	Colore Color	Prezzo Retail con Iva Retail price with Vat	Codice campione Sample code	Campionario nr. Sample box n.
D21103H361B04		1.750,00			D21103H735647		4.500,00		
Piano: P.L. 28 Kg; V. 0,262 mc Top: G.W. 28 Kg; V. 0,262 cbm					Piano: P.L. 30 Kg; V. 0,262 mc Top: G.W. 30 Kg; V. 0,262 cbm				
	Vetro trasparente Transparent glass		ND/NA			Marmo rosso Lepanto Red Lepanto marble		ND/NA	
	Acciaio vern. Nero Ral. 9005 opaco Painted steel matt Black Ral 9005		VER09103	7		Acciaio vern. Nero Ral. 9005 opaco Painted steel matt Black Ral 9005		VER09103	7
D21103H361B26		2.500,00			D21103H762656		4.000,00		
Piano: P.L. 28 Kg; V. 0,262 mc Top: G.W. 28 Kg; V. 0,262 cbm					Piano: P.L. 28 Kg; V. 0,262 mc Top: G.W. 28 Kg; V. 0,262 cbm				
	Vetro trasparente Transparent glass		ND/NA			Marmo verde Alpi Green Alpi mable		ND/NA	
	Acciaio ver. Oro lucido metallizzato Painted steel glossy metallic Gold color		MET112L1	7		Acciaio vern. Nero Ral. 9005 opaco Painted steel matt Black Ral 9005		VER09103	7
D21103H363596		3.400,00			D21103H792632		4.700,00		
Piano: P.L. 30 Kg; V. 0,262 mc Top: G.W. 30 Kg; V. 0,262 cbm					Piano: P.L. 30 Kg; V. 0,262 mc Top: G.W. 30 Kg; V. 0,262 cbm				
	Marmo Carrara Bianco levigato White polished Carrara marble		MAR00201	8		Marmo nero Galaxy Black Galaxy marble		ND/NA	
	Acciaio vern. Nero Ral. 9005 opaco Painted steel matt Black Ral 9005		VER09103	7		Acciaio vern. Nero Ral. 9005 opaco Painted steel matt Black Ral 9005		VER09103	7

ANAPO
by Gordon Guillaumier
2014
Tavolini

Tavolo con base in acciaio verniciato di colore nero RAL 9005* e piano in vetro temperato spessore 15 mm. o in MDF con finitura in castagno oppure in marmo bianco Carrara. Uso solo interno.





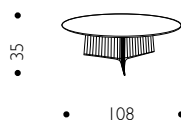





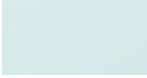

Coffee tables

Table with black RAL 9005* painted steel structure and tempered glass th.15 mm. or chestnut wooden finished or marble Carrara white top. Indoor use only.



ø 108 H. 35 / ø 108 H. 35
Struttura P.L. 7 Kg; V. 0,408 mc
Structure G.W. 7 Kg; V. 0,408 cbm



Codice Code	Colore Color	Prezzo Retail con Iva Retail price with Vat	Codice campione Sample code	Campionario nr. Sample box n.	Codice Code	Colore Color	Prezzo Retail con Iva Retail price with Vat	Codice campione Sample code	Campionario nr. Sample box n.
D21105H361B04		2.150,00			D21105H735647		5.600,00		
Piano: P.L. 32 Kg; V. 0,408 mc Top: G.W. 32 Kg; V. 0,408 cbm					Piano: P.L. 45 Kg; V. 0,408 mc Top: G.W. 45 Kg; V. 0,408 cbm				
	Vetro trasparente Transparent glass		ND/NA			Marmo rosso Lepanto Red Lepanto marble		ND/NA	
	Acciaio vern. Nero Ral. 9005 opaco Painted steel matt Black Ral 9005		VER091O3	7		Acciaio vern. Nero Ral. 9005 opaco Painted steel matt Black Ral 9005		VER091O3	7
D21105H361B04		2.750,00			D21105H762656		5.200,00		
Piano: P.L. 32 Kg; V. 0,408 mc Top: G.W. 32 Kg; V. 0,408 cbm					Piano: P.L. 45 Kg; V. 0,408 mc Top: G.W. 45 Kg; V. 0,408 cbm				
	Vetro trasparente Transparent glass		ND/NA			Marmo verde Alpi Green Alpi mable		ND/NA	
	Acciaio ver. Oro lucido metallizzato Painted steel glossy metallic Gold color		MET112L1	7		Acciaio vern. Nero Ral. 9005 opaco Painted steel matt Black Ral 9005		VER091O3	7
D21105H363596		4.200,00			D21105H792632		5.800,00		
Piano: P.L. 45 Kg; V. 0,408 mc Top: G.W. 45 Kg; V. 0,408 cbm					Piano: P.L. 45 Kg; V. 0,408 mc Top: G.W. 45 Kg; V. 0,408 cbm				
	Marmo Carrara Bianco levigato White polished Carrara marble		MAR002O1	8		Marmo nero Galaxy Black Galaxy marble		ND/NA	
	Acciaio vern. Nero Ral. 9005 opaco Painted steel matt Black Ral 9005		VER091O3	7		Acciaio vern. Nero Ral. 9005 opaco Painted steel matt Black Ral 9005		VER091O3	7

CARMINA

by Ludovica + Roberto
Palomba
2017

Tavolini

Struttura in tondino di acciaio e piani in lamiera di alluminio verniciato a polvere poliestere, nei colori: nude, sabbia o nero.
Il piano superiore può essere quadrato o rotondo. Uso solo interno.

Coffee tables

Steel rod structure and shelf in polyester powder coated aluminum sheet in the colors: nude, sand or black.
The upper shelf can be square or round shaped in the colors: nude, sand or black. Indoor use only.

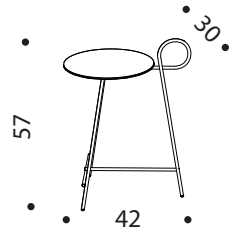

L. 42 P. 30 H. 57; P.L. 5 Kg; V. 0,120 mc
W. 42 D. 30 H. 57; G.W. 5 Kg; V. 0,120 cbm

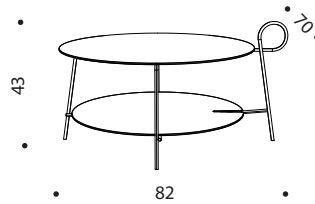

L. 82 P. 70 H. 43; P.L. 18 Kg; V. 0,415 mc
W. 82 D. 70 H. 43; G.W. 18 Kg; V. 0,415 cbm

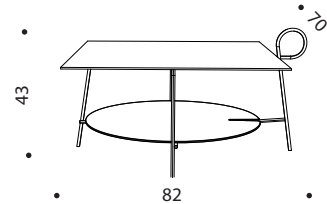

L. 82 P. 70 H. 43; P.L. 20 Kg; V. 0,415 mc
W. 82 D. 70 H. 43; G.W. 20 Kg; V. 0,415



Codice
Code

D30080H432152

Prezzo Retail con Iva
Retail price with Vat

525,00

Codice campione
Sample code

VER152O1

Campionario nr.
Sample box n.

6

Alluminio-Acciaio verniciati Nude
Painted Aluminim-Steel Nude color



Codice
Code

D30080H432011

Prezzo Retail con Iva
Retail price with Vat

525,00

Codice campione
Sample code

VER011O1

Campionario nr.
Sample box n.

6

Alluminio-Acciaio verniciati Sabbia
Painted Aluminim-Steel Sand color



Codice
Code

D30080H432091

Prezzo Retail con Iva
Retail price with Vat

525,00

Codice campione
Sample code

VER091O5

Campionario nr.
Sample box n.

7

Alluminio-Acciaio verniciati Nero
Painted Aluminim-Steel Black



Codice
Code

Colore
Color

Prezzo Retail con Iva
Retail price with Vat

D30112H432152

1.395,00

Codice campione
Sample code

Campionario nr.
Sample box n.



Alluminio-Acciaio verniciati Nude
Painted Aluminim-Steel Nude color

VER152O1

6



Codice
Code

Colore
Color

Prezzo Retail con Iva
Retail price with Vat

D30112H432011

1.395,00

Codice campione
Sample code

Campionario nr.
Sample box n.

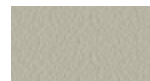

Alluminio-Acciaio verniciati Sabbia
Painted Aluminim-Steel Sand color

VER011O1

6



Codice
Code

Colore
Color

Prezzo Retail con Iva
Retail price with Vat

D30112H432091

1.395,00

Codice campione
Sample code

Campionario nr.
Sample box n.



Alluminio-Acciaio verniciati Nero
Painted Aluminim-Steel Black

VER091O5

7



Codice
Code

Colore
Color

Prezzo Retail con Iva
Retail price with Vat

D30202H432152

1.395,00

Codice campione
Sample code

Campionario nr.
Sample box n.



Alluminio-Acciaio verniciati Nude
Painted Aluminim-Steel Nude color

VER152O1

6



Codice
Code

Colore
Color

Prezzo Retail con Iva
Retail price with Vat

D30202H432011

1.395,00

Codice campione
Sample code

Campionario nr.
Sample box n.

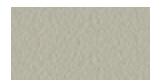

Alluminio-Acciaio verniciati Sabbia
Painted Aluminim-Steel Sand color

VER011O1

6



Codice
Code

Colore
Color

Prezzo Retail con Iva
Retail price with Vat

D30202H432091

1.395,00

Codice campione
Sample code

Campionario nr.
Sample box n.



Alluminio-Acciaio verniciati Nero
Painted Aluminim-Steel Black

VER091O5

7

CUGINETTO

 by Enzo Mari
1974

Tavolini

Struttura in profilati di acciaio verniciati di colore nero antracite. Piano circolare o quadrato in vetro temperato, spessore 8 mm. Uso solo interno.

Coffee tables

Black anthracite painted steel sections structure with tempered glass th. 8 mm. top. Indoor use only.

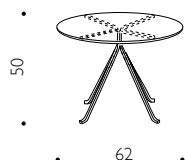
 Tavolino circolare/
Round coffee table

 ø 62 H. 50; P.L. 14 Kg; V. 0,055 mc
ø 62 H. 50; G.W. 14 Kg; V. 0,055 cbm

 Codice
Code

D05041H361B04

 Prezzo Retail con Iva
Retail price with Vat

760,00

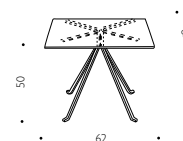
 Tavolino quadrato/
Square coffee table

 ø 62 H. 50; P.L. 14 Kg; V. 0,055 mc
ø 62 H. 50; G.W. 14 Kg; V. 0,055 cbm

 Codice
Code

D05061H361B04

 Prezzo Retail con Iva
Retail price with Vat

760,00

 Codice campione
Sample code

 Campionario nr.
Sample box n.

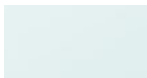
 Vetro trasparente
Transparent glass

ND/NA

 Acciaio verniciato Nero antracite
Anthracite Black painted steel

VER05701

7

FRATELLO
by Enzo Mari
1974
Tavolo

Struttura in profilati di acciaio verniciati di colore nero antracite collegati da una trave in massello di faggio, essenza di noce Canaletto, essenza di rovere fossile oppure essenza di rovere tinto nero. Piani rettangolari in vetro temperato spessore 10 mm. Uso solo interno.

Table

Structure in anthracite black painted steel sections connected by a solid beech beam, fossil oak, Canaletto walnut or black lacquered oak. Rectangular tops in tempered glass 10 mm thick. Indoor use only.

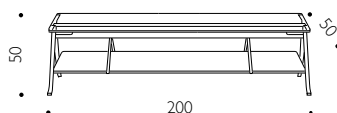

L. 200 P. 50 H. 50
W. 200 D. 50 H. 50
P.L. 88; Kg; V. 0,145 mc
G.W. 88; Kg; V. 0,145 cbm





Codice Code	Versione Version	Prezzo Retail con Iva Retail price with Vat	Codice Code	Versione Version	Prezzo Retail con Iva Retail price with Vat
D04055H345B08	Faggio Beech	3.340,00	D04055H347B08	Rovere fossile Fossil oak	3.460,00
D04055H346B08	Noce Walnut	3.360,00	D04055H348B11	Rovere Oak	3.360,00



 Trave in faggio
Beech beam

Colore Color	Codice campione Sample code	Campionario nr. Sample box n.
	Acciaio verniciato Nero Antracite Anthracite Black painted steel VER057O1	7
	Legno di Faggio Naturale Natural Beech wood LEMFA154O1	10



 Trave in noce Canaletto
Canaletto walnut beam

Colore Color	Codice campione Sample code	Campionario nr. Sample box n.
	Acciaio verniciato Nero Antracite Anthracite Black painted steel VER057O1	7
	Legno di Noce Canaletto Naturale Natural Canaletto Walnut wood LEMNOF96O1	10

 Trave in rovere fossile
Fossil oak beam

Colore Color	Codice campione Sample code	Campionario nr. Sample box n.
	Acciaio verniciato Nero Antracite Anthracite Black painted steel VER057O1	7
	Legno di Rovere fossile Naturale Natural fossil Oak wood LEIRF154O1	10

 Trave in rovere ebanizzato
Black lacquered oak beam

Colore Color	Codice campione Sample code	Campionario nr. Sample box n.
	Acciaio verniciato Nero Antracite Anthracite Black painted steel VER057O1	7
	Legno di Rovere ebanizzato Ebonized Oak wood LEMRO096O1	10

PING I, IIby Giuseppe Chigiotti
2008**Svuotatasche e tavolino**

Svuotatasche (Ping I) e tavolino (Ping II) in alluminio lucidato. Uso solo interno. ø 22,5 H. 50; P.L. 1,3 Kg (Ping I)/ 2,5 Kg. (Ping II); V. 0,030 mc

Holder and small table

Polished aluminum holder (Ping I) and small table (Ping II). Indoor use only. ø 22,5 H. 50; G.W. 1,3 Kg (Ping I)/ 2,5 Kg. (Ping II); V. 0,030 cbm



ø 25,5 H. 50;
P.L. 1,3 Kg; V. 0,030 mc
ø 25,5 H. 50;
G.W. 1,3 Kg; V. 0,030 cbm

ø 25,5 H. 50;
P.L. 2,5 Kg; V. 0,030 mc
ø 25,5 H. 50;
G.W. 2,5 Kg; V. 0,030 cbm

PING I

Codice Code	Colore Color	Prezzo Retail con Iva Retail price with Vat
DP840J0440114		235,00

PING II

Codice Code	Colore Color	Prezzo Retail con Iva Retail price with Vat
DP8450H440114		320,00

Codice campione Sample code	Campionario nr. Sample box n.
MET114L1	7

Alluminio
AluminumPING I
Svuotatasche - HolderPING II
Tavolino - Small table**SANGAKU**by Elena Salmistraro
2021**Tavolino**

Tavolino con quattro piani circolari sovrapposti tra loro, struttura in tubo di acciaio verniciato a polvere poliestere in quattro colori. Piani diametro 42 cm. in acciaio, piani diametro 82 cm. in vetro decorato e vetro con bordo sfumato. Uso solo interno.

Coffee table

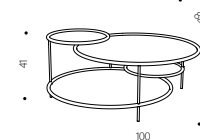

Small table with four circular tops overlapping each other, structure in polyester powder coated steel tube in four colors. Tops diameter 42 cm. in steel, tops diameter 82 cm. in decorated glass and glass with gradient edge. Indoor use only.



L. 100 P. 82 H. 41; P.L. 31 Kg; V. 0,413 mc
W. 100 D. 82 H. 41; G.W. 31 Kg; V. 0,413 cbm

Texture Combusto
Texture CombustoTexture Krakatoa
Texture KrakatoaTexture Anti-Atlas
Texture Anti-AtlasTexture Candyland
Texture Candyland





Codice Code	Prezzo Retail con Iva Retail price with Vat	Codice campione Sample code	Campionario nr. Sample box n.
DA5625H517G40	2.465,00		
		Vetro stampato Printed glass	ND/NA
		Acciaio verniciato verde Green painted steel	ND/NA

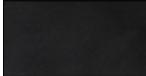



Codice Code	Prezzo Retail con Iva Retail price with Vat	Codice campione Sample code	Campionario nr. Sample box n.
DA5625H517G41	2.465,00		
		Vetro stampato Printed glass	ND/NA
		Acciaio verniciato nero Black painted steel	ND/NA

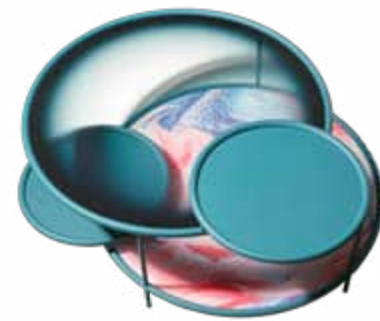

Codice Code	Prezzo Retail con Iva Retail price with Vat	Codice campione Sample code	Campionario nr. Sample box n.
DA5625H517G42	2.465,00		
		Vetro stampato Printed glass	ND/NA
		Acciaio verniciato giallo Yellow painted steel	ND/NA



Codice Code	Prezzo Retail con Iva Retail price with Vat	Codice campione Sample code	Campionario nr. Sample box n.
DA5625H517G43	2.465,00		
		Vetro stampato Printed glass	ND/NA
		Acciaio verniciato blu Blue painted steel	ND/NA

SERENOby Fredrikson Stallard
2014**Tavolino**

Sculture con finitura metallizzata realizzata mediante tecnologia Sputtering nel colore titanio e oro. Piano in particelle di legno spessore 18 mm. rivestito con lamiera a forte spessore di acciaio inox lucidato a specchio oppure in vetro extrachiaro spessore 15 mm. Uso solo interno.

Small table

Sculpture legs in cast aluminum with metallic finish made by Sputtering technology in titanium color or gold color. Top in wood particles 18mm thick with a thick plate of mirror-polished stainless steel or extra clear glass 15 mm thick. Indoor use only.

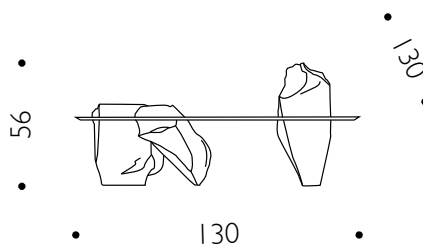

L. 130 P. 130 H. 56
W. 130 D. 130 H. 56
P.L. 135 Kg; V. 1,796 mc
G.W. 135 Kg; V. 1,796 cbm

Piani/Tops:

Colore Color	Codice campione Sample code	Campionario nr. Sample box n.
 Alluminio metallizzato color Oro Gold color metallized aluminum	MET112L1	7
 Alluminio metallizzato color Titanio Titanium color metallized aluminum	MET118L1	7
 Vetro Glass		



Struttura/Structure

Colore Color	Codice campione Sample code	Campionario nr. Sample box n.
 Acciaio inox lucidato Polished stainless steel	META95L1	7





Codice Code	Prezzo Retail con Iva Retail price with Vat	Codice campione Sample code	Campionario nr. Sample box n.
D01055H453B37	10.755,00		
	Acciaio inox lucidato Polished stainless steel	META95L1	7
	Alluminio metallizzato color Oro Gold color metallized aluminum	MET112L1	7



Codice Code	Prezzo Retail con Iva Retail price with Vat	Codice campione Sample code	Campionario nr. Sample box n.
D01055H453B38	10.755,00		
	Acciaio inox lucidato Polished stainless steel	META95L1	7
	Alluminio metallizzato color Titanio Titanium color metallized aluminum	MET118L1	7





P.L. 155 Kg; V. 1,796 mc
G.W. 155 Kg; V. 1,796 cbm

Codice Code	Prezzo Retail con Iva Retail price with Vat	Codice campione Sample code	Campionario nr. Sample box n.
D01055H454B26	5.995,00		
	Vetro Glass	ND/NA	
	Alluminio metallizzato color Oro Gold color metallized aluminum	MET112L1	7



P.L. 155 Kg; V. 1,796 mc
G.W. 155 Kg; V. 1,796 cbm

Codice Code	Prezzo Retail con Iva Retail price with Vat	Codice campione Sample code	Campionario nr. Sample box n.
D01055H454G45	5.995,00		
	Vetro Glass	ND/NA	x
	Alluminio metallizzato color Titanio Titanium color metallized aluminum	MET118L1	7

TOTTORI

 by Kateryna Sokolova
2021

Tavolini

Tavolini realizzati in tre differenti dimensioni contraddistinti da un "inusuale" appoggio a terra su tre gambe. Gli elementi distintivi del tavolino sono un piano con una forma morbida ed arrotondata e le gambe di generoso diametro. Il piano è realizzato in mdf con spessore 30mm. con bordo sagomato a "saponetta" ed angoli arrotondati, gambe in legno massello tornito di diametro 95mm., con la parte in appoggio a terra arrotondata a semisfera. La finitura è una laccatura lucida in tre varianti di colore nelle tinte pastello. Uso solo interno.

Coffee tables

The collection is completed by a series of coffee tables in three different sizes, each with an unusual three-leg base. The distinctive features of these small tables are the soft, rounded shape of the MDF top with a shaped edge, and by the generous diameter of the turned solid wood legs. The top is made of MDF with a thickness of 30mm. with "soap" shaped edge and rounded corners, legs in turned solid wood with a diameter of 95mm, with the part resting on the ground rounded into a hemisphere. The finish is a glossy lacquer proposed in three pastel shades. Indoor use only.

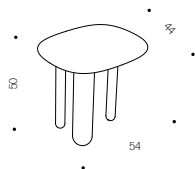

L. 54 P. 44 H. 50
W. 54 D. 44 H. 50
P.L. 10 Kg; V. 0,122 mc
G.W. 10 Kg; V. 0,122 cbm

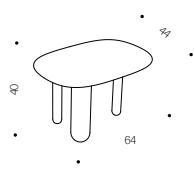

L. 64 P. 44 H. 40
W. 64 D. 44 H. 40
P.L. 10 Kg; V. 0,116 mc
G.W. 10 Kg; V. 0,116 cbm

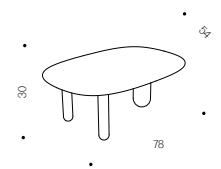

L. 78 P. 54 H. 30
W. 78 D. 54 H. 30
P.L. 11 Kg; V. 0,130 mc
G.W. 11 Kg; V. 0,130 cbm



Codice
Code

Colore
Color

Prezzo Retail con Iva
Retail price with Vat

DA5660H123072

795,00



MDF laccato blu
MDF lacquered blue color

DA5660H123005

795,00

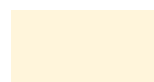

MDF laccato crema
MDF lacquered cream color

DA5660H123081

795,00



MDF laccato marrone
MDF lacquered brown color

Codice
Code

Colore
Color

Prezzo Retail con Iva
Retail price with Vat

DA5662H123072

815,00



MDF laccato blu
MDF lacquered blue color

DA5662H123005

815,00

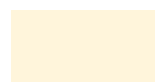

MDF laccato crema
MDF lacquered cream color

DA5662H123081

815,00



MDF laccato marrone
MDF lacquered brown color

Codice
Code

Colore
Color

Prezzo Retail con Iva
Retail price with Vat

DA5661H123072

950,00



MDF laccato blu
MDF lacquered blue color

DA5661H123005

950,00

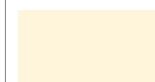

MDF laccato crema
MDF lacquered cream color

DA5661H123081

950,00



MDF laccato marrone
MDF lacquered brown color

TOTTORI

 by Kateryna Sokolova
2021

Tavolini

Tavolini realizzati in tre differenti dimensioni contraddistinti da un "inusuale" appoggio a terra su quattro gambe. Gli elementi distintivi del tavolino sono un piano con una forma morbida ed arrotondata e le gambe di generoso diametro. Il piano è realizzato in mdf con spessore 30mm. con bordo sagomato a "saponetta" ed angoli arrotondati, gambe in legno massello tornito di diametro 95mm., con la parte in appoggio a terra arrotondata a semisfera. La finitura è una laccatura lucida in tre varianti di colore nelle tinte pastello. Uso solo interno.

Coffee tables

The collection is completed by a series of coffee tables in three different sizes, each with an unusual four-leg base. The distinctive features of these small tables are the soft, rounded shape of the MDF top with a shaped edge, and by the generous diameter of the turned solid wood legs. The top is made of MDF with a thickness of 30mm. with "soap" shaped edge and rounded corners, legs in turned solid wood with a diameter of 95mm, with the part resting on the ground rounded into a hemisphere. The finish is a glossy lacquer proposed in three pastel shades. Indoor use only.

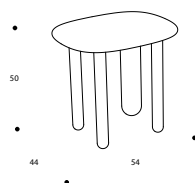



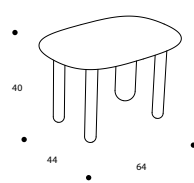

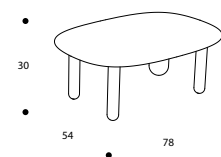

L. 54 P. 44 H. 50
W. 54 D. 44 H. 50
P.L. 10 Kg; V. 0,122 mc
G.W. 10 Kg; V. 0,122 cbm



L. 64 P. 44 H. 40
W. 64 D. 44 H. 40
P.L. 10 Kg; V. 0,116 mc
G.W. 10 Kg; V. 0,116 cbm

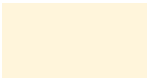
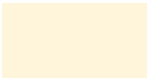
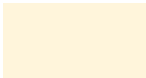

L. 78 P. 54 H. 30
W. 78 D. 54 H. 30
P.L. 11 Kg; V. 0,130 mc
G.W. 11 Kg; V. 0,130 cbm

Codice Code	Colore Color	Prezzo Retail con Iva Retail price with Vat	Codice Code	Colore Color	Prezzo Retail con Iva Retail price with Vat	Codice Code	Colore Color	Prezzo Retail con Iva Retail price with Vat
DA5680H123072	 MDF laccato blu MDF lacquered blue color	890,00	DA5682H123072	 MDF laccato blu MDF lacquered blue color	910,00	DA5681H123072	 MDF laccato blu MDF lacquered blue color	1.050,00
DA5680H123005	 MDF laccato crema MDF lacquered cream color	890,00	DA5682H123005	 MDF laccato crema MDF lacquered cream color	910,00	DA5681H123005	 MDF laccato crema MDF lacquered cream color	1.050,00
DA5680H123081	 MDF laccato marrone MDF lacquered brown color	890,00	DA5682H123081	 MDF laccato marrone MDF lacquered brown color	910,00	DA5681H123081	 MDF laccato marrone MDF lacquered brown color	1.050,00

ZAGAZIG
by Driade Lab
2017

Tavolini

Struttura in tondino di acciaio verniciato a polvere poliestere color oro. Piano in bi-laminato e grafica con decoro floreale o a righe, realizzata tramite stampa digitale. La versione con il decoro a righe prevede il tavolino L. 113 P. 74 H. 27 con decoro bianco e rosso, mentre nelle altre tre misure con decoro bianco e nero. Uso solo interno.

Coffee tables

Structure in polyester powder gold color coated steel rod. Top in bi-laminate and graphic with flower or striped pattern made by digital printing. The version with the striped pattern is also available in the size 113x74x27 with white and red decoration, the other three side tables with black and white decoration. Indoor use only.

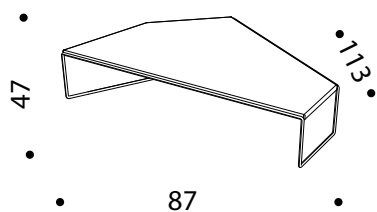

L. 87 P. 113 H. 47
W. 87 D. 113 H. 47
P.L. 28 Kg; V. 0,64 mc
G.W. 28 Kg; V. 0,64 cbm

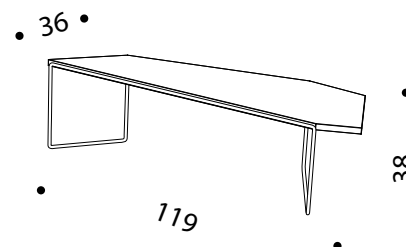

L. 119 P. 36 H. 38
W. 119 D. 36 H. 38
P.L. 13 Kg; V. 0,22 mc
G.W. 13 Kg; V. 0,22 cbm

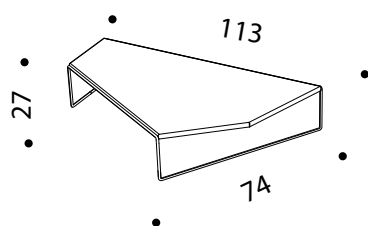

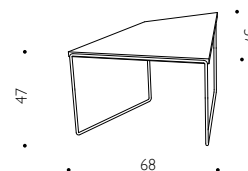

L. 113 P. 74 H. 27
W. 113 D. 74 H. 27
P.L. 23 Kg; V. 0,36 mc
G.W. 23 Kg; V. 0,36 cbm

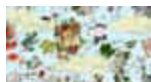

L. 68 P. 57 H. 47
W. 68 D. 57 H. 47
P.L. 11 Kg; V. 0,23 mc
G.W. 11 Kg; V. 0,23 cbm

Piani/Tops:

Colore Color	Codice campione Sample code	Campionario nr. Sample box n.
 Laminato Floreale Floral decoration laminate	LAFLO12101	10
 Laminato Bianco/Nero White/Black laminate	LARIG12601	10
 Laminato Bianco/Rosso White/Red laminate	LARIG12501	10

Struttura/Structure:

Colore Color	Codice campione Sample code	Campionario nr. Sample box n.
 Acciaio ver. Oro lucido metallizzato Painted steel glossy metallic Gold color	MET112L1	7

L. 87 P. 113 H. 47; W. 87 D. 113 H. 47





Codice
Code

Prezzo Retail con Iva
Retail price with Vat

D13103H368B34 1.530,00

	Codice campione Sample code	Campionario nr. Sample box n.
 Laminato Floreale Floral decoration laminate	LAFLO121O1	10
 Acciaio ver. Oro lucido metallizzato Painted steel glossy metallic Gold color	MET112L1	6

D13103H368B35 1.530,00

 Laminato Bianco/Nero White/Black laminate	LARIG126O1	10
 Acciaio ver. Oro lucido metallizzato Painted steel glossy metallic Gold color	MET112L1	6



L. 113 P. 74 H. 27; W. 113 D. 74 H. 27



Codice
Code

Prezzo Retail con Iva
Retail price with Vat

D13065H368B34 1.380,00

	Codice campione Sample code	Campionario nr. Sample box n.
 Laminato Floreale Floral decoration laminate	LAFLO121O1	10
 Acciaio ver. Oro lucido metallizzato Painted steel glossy metallic Gold color	MET112L1	7

D13065H368B36 1.380,00

 Laminato Bianco/Rosso White/Red laminate	LARIG125O1	10
 Acciaio ver. Oro lucido metallizzato Painted steel glossy metallic Gold color	MET112L1	7

L. 119 P. 36 H. 38; W. 119 D. 36 H. 38



Codice
Code

Prezzo Retail con Iva
Retail price with Vat

D13055H368B34 1.200,00

	Codice campione Sample code	Campionario nr. Sample box n.
 Laminato Floreale Floral decoration laminate	LAFLO121O1	10
 Acciaio ver. Oro lucido metallizzato Painted steel glossy metallic Gold color	MET112L1	6

D13055H368B35 1.200,00

 Laminato Bianco/Nero White/Black laminate	LARIG126O1	10
 Acciaio ver. Oro lucido metallizzato Painted steel glossy metallic Gold color	MET112L1	6



L. 68 P. 57 H. 47; W. 68 D. 57 H. 47



Codice
Code

Prezzo Retail con Iva
Retail price with Vat

D13141H368B34 1.295,00

	Codice campione Sample code	Campionario nr. Sample box n.
 Laminato Floreale Floral decoration laminate	LAFLO121O1	10
 Acciaio ver. Oro lucido metallizzato Painted steel glossy metallic Gold color	MET112L1	7

D13141H368B35 1.295,00

 Laminato Bianco/Nero White/Black laminate	LARIG126O1	10
 Acciaio ver. Oro lucido metallizzato Painted steel glossy metallic Gold color	MET112L1	7

WATERFALL

by Fredrikson Stallard
2012

Tavolino

Tavolo in poliuretano Baydur® verniciato nei colori: bianco, oro e blu. Uso solo interno.

Coffee tables

White, gold or blue lacquered polyurethane Baydur® coffee table. Indoor use only.

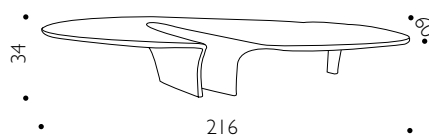

L. 216 P. 60 H. 34
W. 216 D. 60 H. 34
P.L. 42 Kg; V. 0,710 mc
G.W. 42 Kg; V. 0,710 cbm

Piani/Tops:

Colore Color	Codice campione Sample code	Campionario nr. Sample box n.
 Poliuretano Bianco Ral 9003 lucido Glossy White Ral 9003 Polyurethane	VER002L4	6
 Poliuretano Oro met. Pantone 125C Metallized Pantone Gold 125C	VER112L1	6
 Poliuretano Blu Pantone 296C Blue Pantone 296C Polyurethane	VER072L1	6



Codice Code	Prezzo Retail con Iva Retail price with Vat	Codice campione Sample code	Campionario nr. Sample box n.
D00285H433002	3.500,00		
		Poliuretano Bianco Ral 9003 lucido Glossy White Ral 9003 Polyurethane	VER002L4 6



Codice Code	Prezzo Retail con Iva Retail price with Vat	Codice campione Sample code	Campionario nr. Sample box n.
D00285H433112	3.500,00		
		Poliuretano Oro met. Pantone 125C Metallized Pantone Gold 125C	VER112L1 6



Codice Code	Prezzo Retail con Iva Retail price with Vat	Codice campione Sample code	Campionario nr. Sample box n.
D00285H433072	3.500,00		
		Poliuretano Blu Pantone 296C Blue Pantone 296C Polyurethane	VER072L1 6

CONTENITORI/*CABINETS*

ERCOLE E AFRODITE

by Driade Lab
2014

Contenitori

Sistema di contenitori modulari aggregabili posizionati su un basamento in agglomerato di particelle di pioppo con rinforzo in tubolare di acciaio inserito all'interno, con finitura in legno di rovere sbiancato o rovere tinto grigio. Struttura dei contenitori in listellare laccato opaco nei colori bianco o nero. Moduli con anta a libro o con anta a battente. Moduli a cassettono con vassoio interno. Frontali realizzati in poliuretano ad alta densità laccati opaco nei colori bianco o nero. Uso solo interno.

Cabinets

Modular combinable box system on a base made of poplar chipboard reinforced with tubular steel inserted inside, with bleached oak or grey painted oak finish. Structure of the containers in wooden strips, matt lacquering in black or white. Modules with folding wing or hinged doors. Modules with pull-out drawers and internal tray. Front made of high density polyurethane, matt lacquering in white or black color. Indoor use only.



Contenitore bianco su pedana
White cabinet on a base



Contenitore nero su pedana
Black cabinet on a base





Contenitore bianco su piedini
White cabinet on feet



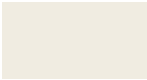

Contenitore nero su piedini
Black cabinet on feet

Contenitori/Cabinets:

Colore Color	Codice campione Sample code	Campionario nr. Sample box n.
 MDF laccato Bianco Ral 9010 opaco <i>Matt White Ral 9010 lacquered MDF</i>	VER002O6	6
 MDF laccato Nero Ral 9005 opaco <i>Matt Black Ral 9005 lacquered</i>	VER091O3	7

Pedana/Base:

Colore Color	Codice campione Sample code	Campionario nr. Sample box n.
 Legno di Rovere sbiancato <i>Bleached Oak wood</i>	LEIROF97O1	10
 Legno di Rovere tinto grigio <i>Grey stained Oak wood</i>	LEIRO045O1	10

Composizione 1/Composition 1

Pedana L. 205
Base W. 205
Modulo L. 90 P. 60 H. 111 con Anta a libro sx
Module W. 90 D. 60 H. 111 with left folding wing
Modulo L. 90 P. 60 H. 111 con 2 Cassettoni e vassoio interno
Module W. 90 D. 60 H. 111 with 2 pull-out drawers and internal tray
Pedana: P.L. 88 Kg; V. 0,506 mc
Base: G.W. 88 Kg; V. 0,506 cbm
Modulo L. 90 anta: P.L. 128 Kg; V. 0,720 mc
Module W. 90 door: G.W. 128 Kg; V. 0,720 cbm
Modulo L. 90 cassettoni: P.L. 155 Kg; V. 0,720 mc
Module W. 90 drawers: G.W. 155 Kg; V. 0,720 cbm

Composizione con pedana/Composition with base

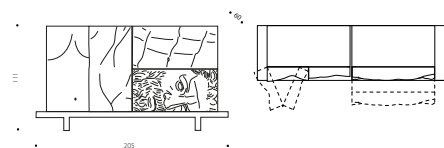

Composizione senza pedana/Composition without base

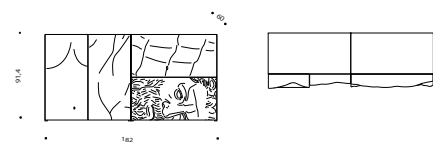

Composizione 2/Composition 2

Pedana L. 205
Base W. 205
Modulo L. 90 P. 60 H. 111 con 2 Cassettoni e vassoio interno
Module W. 90 D. 60 H. 111 with 2 pull-out drawers and internal tray
Modulo L. 90 P. 60 H. 111 con Anta a libro dx
Module W. 90 D. 60 H. 111 with right folding wing
Pedana: P.L. 88 Kg; V. 0,506 mc
Base: G.W. 88 Kg; V. 0,506 cbm
Modulo L. 90 anta: P.L. 128 Kg; V. 0,720 mc
Module W. 90 door: G.W. 128 Kg; V. 0,720 cbm
Modulo L. 90 cassettoni: P.L. 155 Kg; V. 0,720 mc
Module W. 90 drawers: G.W. 155 Kg; V. 0,720 cbm

Composizione con pedana/Composition with base

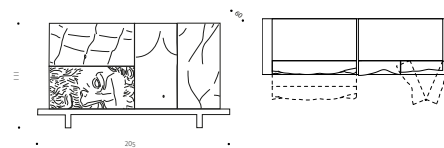

Composizione senza pedana/Composition without base

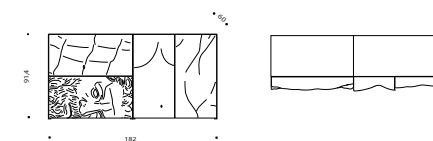

Composizione con base/Composition with base

Codice Code	Versione Version	Prezzo Retail con Iva Retail price with Vat
D10005J371B39	MDF laccato Bianco Ral 9010 opaco Matt White Ral 9010 lacquered MDF	18.500,00
	Legno di Rovere sbiancato Bleached Oak wood	
D10005J371B40	MDF laccato Nero Ral 9005 opaco Matt Black Ral 9005 lacquered	18.500,00
	Legno di Rovere tinto grigio Grey stained Oak wood	

Composizione senza base/Composition without base

Codice Code	Versione Version	Prezzo Retail con Iva Retail price with Vat
D10025J123002	MDF laccato Bianco Ral 9010 opaco Matt White Ral 9010 lacquered MDF	16.300,00
D10025J123091	MDF laccato Nero Ral 9005 opaco Matt Black Ral 9005 lacquered	16.300,00

Composizione con base/Composition with base

Codice Code	Versione Version	Prezzo Retail con Iva Retail price with Vat
D10006J371B39	MDF laccato Bianco Ral 9010 opaco Matt White Ral 9010 lacquered MDF	18.500,00
	Legno di Rovere sbiancato Bleached Oak wood	
D10006J371B40	MDF laccato Nero Ral 9005 opaco Matt Black Ral 9005 lacquered	18.500,00
	Legno di Rovere tinto grigio Grey stained Oak wood	

Composizione senza base/Composition without base

Codice Code	Versione Version	Prezzo Retail con Iva Retail price with Vat
D10026J123002	MDF laccato Bianco Ral 9010 opaco Matt White Ral 9010 lacquered MDF	16.300,00
D10026J123091	MDF laccato Nero Ral 9005 opaco Matt Black Ral 9005 lacquered	16.300,00

Composizione 3/Composition 3

Pedana L. 205
Base W. 205
Modulo L. 45 P. 60 H. 111 con Anta battente sx
Module W. 45 D. 60 H. 111 with left hinged door
Modulo L. 90 P. 60 H. 111 con 2 Cassettoni e vassoio interno
Module W. 90 D. 60 H. 111 with 2 pull-out drawers and internal tray
Modulo L. 45 P. 60 H. 111 con Anta battente dx
Module W. 45 D. 60 H. 111 with right hinged door
Pedana: P.L. 88 Kg; V. 0,506 mc
Base: G.W. 88 Kg; V. 0,506 cbm
Modulo L. 45 anta (2): P.L. 75 Kg; V. 0,428 mc
Module W. 45 door (2): G.W. 75 Kg; V. 0,428 cbm
Modulo L. 90 cassettoni: P.L. 155 Kg; V. 0,720 mc
Module W. 90 drawers: G.W. 155 Kg; V. 0,720 cbm

Composizione con pedana/Composition with base

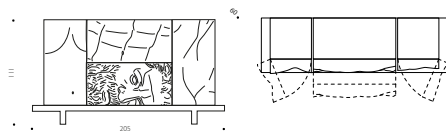

Composizione senza pedana/Composition without base

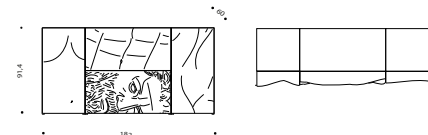

Composizione 6/Composition 6

Pedana L. 205
Base W. 205
Modulo L. 90 P. 60 H. 111 con 2 Cassettoni e vassoio interno
Module W. 90 D. 60 H. 111 with 2 pull-out drawers and internal tray
Modulo L. 45 P. 60 H. 111 con Anta a battente dx
Module W. 45 D. 60 H. 111 with right hinged door
Pedana: P.L. 88 Kg; V. 0,506 mc
Base: G.W. 88 Kg; V. 0,506 cbm
Modulo L. 90 cassettoni: P.L. 155 Kg; V. 0,720 mc
Module W. 90 drawers: G.W. 155 Kg; V. 0,720 cbm
Modulo L. 45 anta: P.L. 75 Kg; V. 0,428 mc
Module W. 45 door: G.W. 75 Kg; V. 0,428 cbm

Composizione con pedana/Composition with base

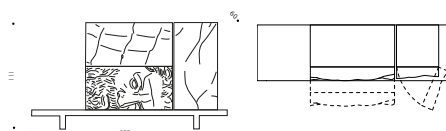

Composizione senza pedana/Composition without base

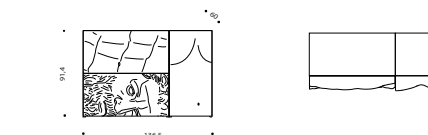

Composizione con base/Composition with base

Codice Code	Versione Version	Prezzo Retail con Iva Retail price with Vat
D10154J371B39	MDF laccato Bianco Ral 9010 opaco Matt White Ral 9010 lacquered MDF	18.600,00
	Legno di Rovere sbiancato Bleached Oak wood	
D10154J 371B40	MDF laccato Nero Ral 9005 opaco Matt Black Ral 9005 lacquered	18.600,00
	Legno di Rovere tinto grigio Grey stained Oak wood	

Composizione senza base/Composition without base

Codice Code	Versione Version	Prezzo Retail con Iva Retail price with Vat
D10164J123002	MDF laccato Bianco Ral 9010 opaco Matt White Ral 9010 lacquered MDF	17.200,00
D10164J123091	MDF laccato Nero Ral 9005 opaco Matt Black Ral 9005 lacquered	17.200,00

Composizione con base/Composition with base

Codice Code	Versione Version	Prezzo Retail con Iva Retail price with Vat
D10253J371B39	MDF laccato Bianco Ral 9010 opaco Matt White Ral 9010 lacquered MDF	15.000,00
	Legno di Rovere sbiancato Bleached Oak wood	
D10253J371B40	MDF laccato Nero Ral 9005 opaco Matt Black Ral 9005 lacquered	15.000,00
	Legno di Rovere tinto grigio Grey stained Oak wood	

Composizione senza base/Composition without base

Codice Code	Versione Version	Prezzo Retail con Iva Retail price with Vat
D10263J123002	MDF laccato Bianco Ral 9010 opaco Matt White Ral 9010 lacquered MDF	13.200,00
D10263J123091	MDF laccato Nero Ral 9005 opaco Matt Black Ral 9005 lacquered	13.200,00

Composizione 8/Composition 8

Pedana L. 112
Base W. 112
Modulo L. 90 P. 60 H. 111 con 2 Cassettoni e vassoio interno
Module W. 90 D. 60 H. 111 with 2 pull-out drawers and internal tray
Pedana: P.L. 63 Kg; V. 0,290 mc
Base: G.W. 63 Kg; V. 0,290 cbm
Modulo L. 90 cassettoni: P.L. 155 Kg; V. 0,720 mc
Module W. 90 drawers: G.W. 155 Kg; V. 0,720 cbm

Composizione con pedana/Composition with base

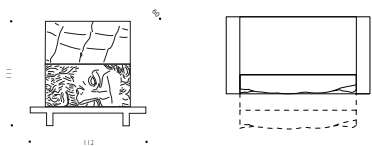

Composizione senza pedana/Composition without base

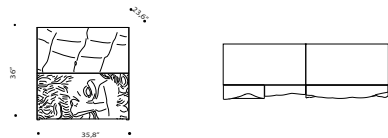

Composizione 9/Composition 9

Pedana L. 112
Base W. 112
Modulo L. 45 P. 60 H. 111 con Anta battente sx
Module W. 45 D. 60 H. 111 with left hinged door
Modulo L. 45 P. 60 H. 111 con Anta battente dx
Module W. 45 D. 60 H. 111 with right hinged door
Pedana: P.L. 63 Kg; V. 0,290 mc
Base: G.W. 63 Kg; V. 0,290 cbm
Modulo L. 45 door (2): P.L. 75 Kg; V. 0,428 mc
Module W. 45 door (2): G.W. 75 Kg; V. 0,428 cbm

Composizione con pedana/Composition with base

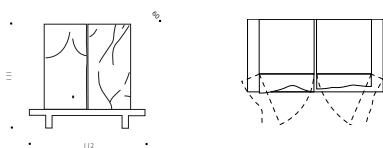

Composizione senza pedana/Composition without base

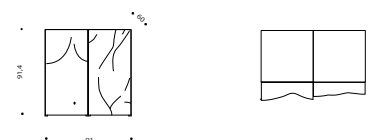

Composizione con base/Composition with base

Codice Code	Versione Version	Prezzo Retail con Iva Retail price with Vat
D10352J371B39	MDF laccato Bianco Ral 9010 opaco Matt White Ral 9010 lacquered MDF	9.950,00
	Legno di Rovere sbiancato Bleached Oak wood	
D10352J371B40	MDF laccato Nero Ral 9005 opaco Matt Black Ral 9005 lacquered	9.950,00
	Legno di Rovere tinto grigio Grey stained Oak wood	

Composizione senza base/Composition without base

Codice Code	Versione Version	Prezzo Retail con Iva Retail price with Vat
D10362J123002	MDF laccato Bianco Ral 9010 opaco Matt White Ral 9010 lacquered MDF	8.950,00
D10362J123091	MDF laccato Nero Ral 9005 opaco Matt Black Ral 9005 lacquered	8.950,00

Composizione con base/Composition with base

Codice Code	Versione Version	Prezzo Retail con Iva Retail price with Vat
D10402J371B39	MDF laccato Bianco Ral 9010 opaco Matt White Ral 9010 lacquered MDF	10.200,00
	Legno di Rovere sbiancato Bleached Oak wood	
D10402J371B40	MDF laccato Nero Ral 9005 opaco Matt Black Ral 9005 lacquered	10.200,00
	Legno di Rovere tinto grigio Grey stained Oak wood	

Composizione senza base/Composition without base

Codice Code	Versione Version	Prezzo Retail con Iva Retail price with Vat
D10422J123002	MDF laccato Bianco Ral 9010 opaco Matt White Ral 9010 lacquered MDF	9.300,00
D10422J123091	MDF laccato Nero Ral 9005 opaco Matt Black Ral 9005 lacquered	9.300,00

HIDALGO
by Driade Lab
2021

Contenitore

L'esterno del mobile è impiallacciato con tranciato di legno nelle finiture Multilaminare Fiammato e Multilaminare Rigato Mosso. La versione verniciata è prevista in due varianti: laccata monocromatica in cinque differenti colori o laccata con un effetto sfumato di due colori e due diverse combinazioni. In tutte le versioni il lato interno è placcato con laminato nero finitu a soft. L'inusuale struttura di supporto è realizzata con un tubo in acciaio verniciato colore nero o acciaio inox lucidato. Uso solo interno.





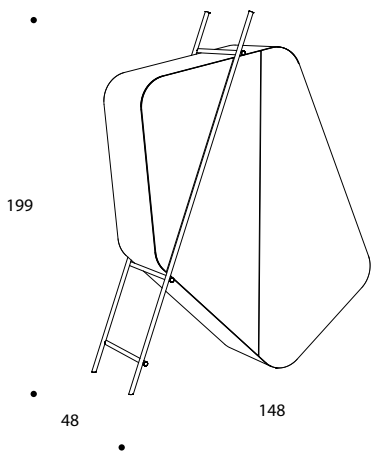



Cabinet

The exterior of the cabinet is veneered with wood veneer in the Flamed Multilaminar and Rigato Mosso Multilaminar finishes. The painted version is available in two versions: monochromatic lacquered in five different colors or lacquered with a shaded effect of two colors and two different combinations. In all versions the inside is plated with black laminate with a soft finish. The unusual support structure is made with a black painted steel tube or polished stainless steel. Indoor use only.

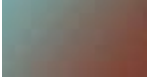



L. 148 P. 48 H. 190
Dimensioni del solo contenitore: L. 140 P. 44 H. 171
W. 148 D. 48 H. 190
Cabinet dimension: W. 140 D. 44 H. 171

Contenitori/Cabinets:

Colore Color	Codice campione Sample code	Campionario nr. Sample box n.	Colore Color	Codice campione Sample code	Campionario nr. Sample box n.
 Multistrato impiall. Tabu rigato marrone <i>Striped Tabu veneer multilayer brown color</i>	LEPRIF98L1	10	 Multistrato impiall. Tabu fiamma o bianco e nero <i>Flamed Tabu veneer multilayer black and white color</i>	LEPF115501	10
 Multistrato laccato sfumato azzurro, mattone <i>Multi-layer lacquered light blue, brick red</i>	ND/NA		 Multistrato laccato sfumato giallo, nero <i>Multi-layer lacquered yellow, black</i>	ND/NA	
 Multistrato laccato bianco RAL 9010 <i>White multi-layer lacquered RAL 9010</i>	ND/NA		 Multistrato laccato verde pallido RAL 6021 <i>Pale green multi-layer lacquered RAL 6021</i>	ND/NA	
 Multistrato laccato blu zaffiro RAL 5003 <i>Blue sapphire multi-layer lacquered RAL 5003</i>	ND/NA		 Multistrato laccato rosso ossido RAL 3009 <i>Oxide red multi-layer lacquered RAL 3009</i>	ND/NA	
 Multistrato laccato arancio sanguigno RAL 2002 <i>Blood orange multi-layer lacquered RAL 2002</i>	ND/NA				

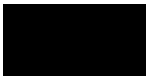
Struttura/Structure:



Colore Color	Codice campione Sample code	Campionario nr. Sample box n.	Colore Color	Codice campione Sample code	Campionario nr. Sample box n.
 Acciaio inossidabile <i>Stainless steel</i>	ND/NA		 Acciaio verniciato nero <i>Black painted steel</i>	ND/NA	

Codice Code	Colore Color	Prezzo Retail con Iva Retail price with Vat	Codice campione Sample code	Campionario nr. Sample box n.
D00164J472F62		12.000,00		
	Multistrato impiall.Tabu rigato marrone <i>Striped Tabu veneer multilayer brown color</i>		LEPRIF98L1	10
	Acciaio inossidabile <i>Stainless steel</i>		ND/NA	

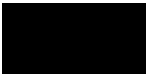

Codice Code	Colore Color	Prezzo Retail con Iva Retail price with Vat	Codice campione Sample code	Campionario nr. Sample box n.
D00164J473F63		10.000,00		
	Multistrato impiall.Tabu fiamma o bianco e nero <i>Flamed Tabu veneer multilayer black and white color</i>		LEPFI155O1	10
	Acciaio verniciato nero <i>Black painted steel</i>		ND/NA	

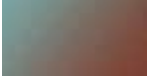

Codice Code	Colore Color	Prezzo Retail con Iva Retail price with Vat	Codice campione Sample code	Campionario nr. Sample box n.
D00164J474F64		16.000,00		
	Multistrato laccato sfumato azzurro, mattone Multi-layer lacquered light blue, brick red		ND/NA	
	Acciaio inossidabile Stainless steel		ND/NA	

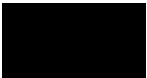

Codice Code	Colore Color	Prezzo Retail con Iva Retail price with Vat	Codice campione Sample code	Campionario nr. Sample box n.
D00164J474G26		16.000,00		
	Multistrato laccato sfumato giallo, nero Multi-layer lacquered yellow, black		ND/NA	
	Acciaio verniciato nero Black painted steel		ND/NA	





Codice
Code

Prezzo Retail con Iva
Retail price with Vat

D00164J474596 8.900,00



Bianco RAL 9010
White RAL 9010
Acciaio verniciato nero
Black painted steel

Codice campione
Sample code

Campionario nr.
Sample box n.

ND/NA
ND/NA



Codice
Code

Prezzo Retail con Iva
Retail price with Vat

D00164J474656 8.900,00



Verde pallido RAL 6021
Pale green RAL 6021
Acciaio verniciato nero
Black painted steel

Codice campione
Sample code

Campionario nr.
Sample box n.

ND/NA
ND/NA



Codice
Code

Prezzo Retail con Iva
Retail price with Vat

D00164J474604 8.900,00



Blu zaffiri o RAL 5003
Blue sapphire RAL 5003
Acciaio verniciato nero
Black painted steel

Codice campione
Sample code

Campionario nr.
Sample box n.

ND/NA
ND/NA



Codice
Code

Prezzo Retail con Iva
Retail price with Vat

D00164J474647 8.900,00



Rosso ossido RAL 3009
Oxide red RAL 3009
Acciaio verniciato nero
Black painted steel

Codice campione
Sample code

Campionario nr.
Sample box n.

ND/NA
ND/NA



Codice
Code

Prezzo Retail con Iva
Retail price with Vat

D00164J474588 8.900,00



Arancio sanguigno RAL 2002
Blood orange RAL 2002
Acciaio verniciato nero
Black painted steel

Codice campione
Sample code

Campionario nr.
Sample box n.

ND/NA
ND/NA

LOVE
by Fabio Novembre
2020

Contenitore

LOVE è un contenitore con due ante laterali a battente e ripiano interno spostabile, con due cassettoni centrali ad estrazione totale. Struttura realizzata in MDF laccato esternamente ed internamente. Scritta LOVE in rilievo con funzione di maniglia realizzata in MDF laccato facilmente sostituibile personalizzando in questo modo il contenitore. Piedini cilindrici regolabili diametro 3,5 cm. ed altezza 10 cm. dello stesso colore della struttura. Uso solo interno.

Cabinet

LOVE is a cabinet with two side hinged doors, with a moveable internal shelf, and with two central full-extension drawers. Structure made of MDF laquered both externally and internally. LOVE lettering in relief as a handle made of lacquered MDF, easily replaceable, thus personalising the storage unit. Adjustable cylindrical feet diameter 3.5 cm. and height 10 cm. in the same colour as the structure. Indoor use only.

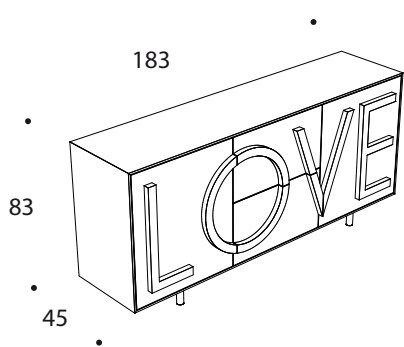

L. 183 P. 45 H. 83
W. 183 D. 45 H. 83
P.L. 150 Kg; V. 0,6423 mc
G.W. 150 kg; V. 0,6423 cbm

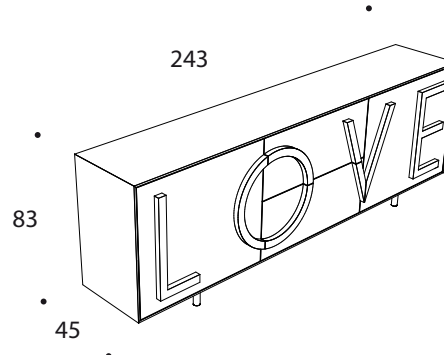



L. 243 P. 45 H. 83
W. 243 D. 45 H. 83
P.L. 181 Kg; V. 0,852 mc
G.W. 181 kg; V. 0,852 cbm

Struttura/Structure:

Colore Color	Codice campione Sample code	Campionario nr. Sample box n.
 MDF laccato Bianco traffic Traffic white lacquered MDF	VER003M7	6
 MDF laccato Nero traffic Traffic black lacquered MDF	VER091M7	7
 MDF laccato Rosso rubino Ruby red lacquered MDF	VER039M4	6

Maniglie/Handles:

Colore Color	Codice campione Sample code	Campionario nr. Sample box n.
 MDF laccato Grigio luce Light grey lacquered MDF	VER045M4	7
 MDF laccato Grigio grafi e Graphite grey lacquered MDF	VER050M5	7
 MDF laccato Rosso traffic Traffic red lacquered MDF	VER039M5	6
 MDF laccato Giallo flu Fluo yellow lacquered MDF	VER022M2	7
 MDF laccato Rosa flu Fluo pink lacquered MDF	VERF57L1	7



L.183 P.45 H.83/W.183 D.45 H.83



L.243 P.45 H.83/W.243 D.45 H.83

Codice
Code D00123J123E05

Prezzo Retail con Iva
Retail price with Vat 4.500,00

Codice
Code D00124J123E05

Prezzo Retail con Iva
Retail price with Vat 5.200,00

MDF laccato Bianco traffic
Traffic white lacquered MDF

MDF laccato Grigio luce
Light grey lacquered MDF



L.183 P.45 H.83/W.183 D.45 H.83



L.243 P.45 H.83/W.243 D.45 H.83

Codice
Code D00123J123E00

Prezzo Retail con Iva
Retail price with Vat 4.500,00

Codice
Code D00124J123E00

Prezzo Retail con Iva
Retail price with Vat 5.200,00

MDF laccato Nero traffic
Traffic black lacquered MDF

MDF laccato Grigio luce
Light grey lacquered MDF



L.183 P.45 H.83/W.183 D.45 H.83



L.243 P.45 H.83/W.243 D.45 H.83

Codice
Code D00123J123E06

Prezzo Retail con Iva
Retail price with Vat 4.500,00

Codice
Code D00124J123E06

Prezzo Retail con Iva
Retail price with Vat 5.200,00

MDF laccato Bianco traffic
Traffic white lacquered MDF

MDF laccato Grigio grafi e
Graphite grey lacquered MDF



L.183 P.45 H.83/W.183 D.45 H.83



L.243 P.45 H.83/W.243 D.45 H.83

Codice
Code D00123J123E09

Prezzo Retail con Iva
Retail price with Vat 4.500,00

Codice
Code D00124J123E09

Prezzo Retail con Iva
Retail price with Vat 5.200,00

MDF laccato Nero traffic
Traffic black lacquered MDF

MDF laccato Grigio grafi e
Graphite grey lacquered MDF



L.183 P.45 H.83/W.183 D.45 H.83



L.243 P.45 H.83/W.243 D.45 H.83

Codice
Code D00123J123B33

Prezzo Retail con Iva
Retail price with Vat 4.500,00

Codice
Code D00124J123B33

Prezzo Retail con Iva
Retail price with Vat 5.200,00

MDF laccato Bianco traffic
Traffic white lacquered MDF

MDF laccato Rosso traffic
Traffic red lacquered MDF



L.183 P.45 H.83/W.183 D.45 H.83



L.243 P.45 H.83/W.243 D.45 H.83

Codice
Code D00123J123E10

Prezzo Retail con Iva
Retail price with Vat 4.500,00

Codice
Code D00124J123E10

Prezzo Retail con Iva
Retail price with Vat 5.200,00

MDF laccato Nero traffic
Traffic black lacquered MDF

MDF laccato Rosso traffic
Traffic red lacquered MDF



L.183 P.45 H.83/W.183 D.45 H.83



L.243 P.45 H.83/W.243 D.45 H.83

Codice
Code D00123J123E07

Prezzo Retail con Iva
Retail price with Vat 4.500,00

Codice
Code D00124J123E07

Prezzo Retail con Iva
Retail price with Vat 5.200,00

MDF laccato Bianco traffic
Traffic white lacquered MDF

MDF laccato Giallo fluo
Fluo yellow lacquered MDF



L.183 P.45 H.83/W.183 D.45 H.83



L.243 P.45 H.83/W.243 D.45 H.83

Codice
Code D00123J123E11

Prezzo Retail con Iva
Retail price with Vat 4.500,00

Codice
Code D00124J123E11

Prezzo Retail con Iva
Retail price with Vat 5.200,00

MDF laccato Nero traffic
Traffic black lacquered MDF

MDF laccato Giallo fluo
Fluo yellow lacquered MDF



L.183 P.45 H.83/W.183 D.45 H.83



L.243 P.45 H.83/W.243 D.45 H.83

Codice
Code D00123J123E08

Prezzo Retail con Iva
Retail price with Vat 4.500,00

Codice
Code D00124J123E08

Prezzo Retail con Iva
Retail price with Vat 5.200,00

MDF laccato Bianco traffic
Traffic white lacquered MDF

MDF laccato Rosa fluo
Fluo pink lacquered MDF



L.183 P.45 H.83/W.183 D.45 H.83



L.243 P.45 H.83/W.243 D.45 H.83

Codice
Code D00123J123E12

Prezzo Retail con Iva
Retail price with Vat 4.500,00

Codice
Code D00124J123E2

Prezzo Retail con Iva
Retail price with Vat 5.200,00

MDF laccato Nero traffic
Traffic black lacquered MDF

MDF laccato Rosa fluo
Fluo pink lacquered MDF



L.183 P.45 H.83/W.183 D.45 H.83



L.243 P.45 H.83/W.243 D.45 H.83

Codice
Code D00123J123E13

Prezzo Retail con Iva
Retail price with Vat 4.500,00

 MDF laccato Rosso rubino
Ruby red lacquered MDF

 MDF laccato Grigio luce
Light grey lacquered MDF

Codice
Code D00124J123E13

Prezzo Retail con Iva
Retail price with Vat 5.200,00

Scritta

Scritta LOVE in rilievo con funzione di maniglia realizzata in MDF laccato facilmente sostituibile personalizzando in questo modo il contenitore. La scritta LOVE è la medesima per le due dimensioni. L. 62 P. 31 H. 26: P.L. 7 Kg. V. 0,05 mc

Lettering

LOVE lettering in relief as a handle made of lacquered MDF, easily replaceable, thus personalising the storage unit. LOVE lettering is the same for the two dimensions. W. 62 D. 31 H. 26: G.W. 7 Kg; V. 0,05 cbm



L.183 P.45 H.83/W.183 D.45 H.83



L.243 P.45 H.83/W.243 D.45 H.83

Codice
Code D00123J123E14

Prezzo Retail con Iva
Retail price with Vat 4.500,00

 MDF laccato Rosso rubino
Ruby red lacquered MDF

 MDF laccato Grigio grafi e
Graphite grey lacquered MDF

Codice
Code D00124J123E14

Prezzo Retail con Iva
Retail price with Vat 5.200,00

Codice
Code D00120O123G47

 MDF laccato Grigio luce
Light grey lacquered MDF

Codice campione
Sample code
VER045M4

Prezzo Retail con Iva
Retail price with Vat 890,00

Campionario nr.
Sample box n.
7



L.183 P.45 H.83/W.183 D.45 H.83



L.243 P.45 H.83/W.243 D.45 H.83

Codice
Code D00123J123E17

Prezzo Retail con Iva
Retail price with Vat 4.500,00

 MDF laccato Rosso rubino
Ruby red lacquered MDF

 MDF laccato Rosso traffic
Traffic red lacquered MDF

Codice
Code D00124J123E17

Prezzo Retail con Iva
Retail price with Vat 5.200,00

Codice
Code D00120O123G30

 MDF laccato Giallo fluo
Fluo yellow lacquered MDF

Codice campione
Sample code
VER022M2

Prezzo Retail con Iva
Retail price with Vat 890,00

Campionario nr.
Sample box n.
7



L.183 P.45 H.83/W.183 D.45 H.83



L.243 P.45 H.83/W.243 D.45 H.83

Codice
Code D00123J123E15

Prezzo Retail con Iva
Retail price with Vat 4.500,00

 MDF laccato Rosso rubino
Ruby red lacquered MDF

 MDF laccato Giallo fluo
Fluo yellow lacquered MDF

Codice
Code D00124J123E15

Prezzo Retail con Iva
Retail price with Vat 5.200,00

Codice
Code D00120O123G48

 MDF laccato Grigio grafi e
Graphite grey lacquered MDF

Codice campione
Sample code
VER050M5

Prezzo Retail con Iva
Retail price with Vat 890,00

Campionario nr.
Sample box n.
7



L.183 P.45 H.83/W.183 D.45 H.83



L.243 P.45 H.83/W.243 D.45 H.83

Codice
Code D00123J123E16

Prezzo Retail con Iva
Retail price with Vat 4.500,00

 MDF laccato Rosso rubino
Ruby red lacquered MDF

 MDF laccato Rosa fluo
Fluo pink lacquered MDF

Codice
Code D00124J123E16

Prezzo Retail con Iva
Retail price with Vat 5.200,00

Codice
Code D00120O123F57

 MDF laccato Rosa fluo
Fluo pink lacquered MDF

Codice campione
Sample code
VERF57L1

Prezzo Retail con Iva
Retail price with Vat 890,00

Campionario nr.
Sample box n.
7

Codice
Code D00120O123G49

 MDF laccato Rosso traffic
Traffic red lacquered MDF

Codice campione
Sample code
VER039M5

Prezzo Retail con Iva
Retail price with Vat 890,00

Campionario nr.
Sample box n.
6

VENUS

by Fabio Novembre
2023

Madia

Madia realizzata con pannelli in fibra di legno a media densità dello spessore di 25mm. Finitura laccata opaco nei colori nero traffico e rosso vino, zoccolo di appoggio a terra in finitura a specchio con piedini di regolazione per la messa a livello. Parte frontale composta da due ante a battente con smusso a 45° con ripiano interno spostabile e due cassettoni a totale estrazione con smusso a 45°. Sistema di apertura delle ante e dei cassettoni mediante push-pull. Vano a giorno con inserita una scultura in marmo ricomposto bianco.

Sideboards

Sideboard made of 25 mm-thick medium-density wood fibreboard. Matt lacquered finish in traffic black and wine red, floor-standing plinth in mirror finish with adjustment feet for leveling. Front composed of two hinged doors with 45° bevel with movable internal shelf and two full-extension drawers with 45° bevel. Door and drawer opening system by means of push-pull. Open compartment with inserted white reconstituted marble sculpture

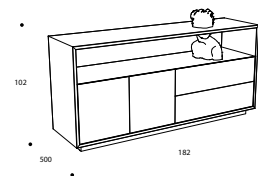

L. 182 P. 50 H. 86,5
W. 182 D. 50 H. 86,5

Codice Code	Colore Color	Prezzo Retail con Iva Retail price with Vat
----------------	-----------------	--

D10213J890596

6.500,00

Codice campione Sample code	Campionario nr. Sample box n.
--------------------------------	----------------------------------

ND/NA

 Marmo ricomposto
Recomposed marble

 Nero traffico
Traffic black

D10213J890B33

6.500,00

Codice campione Sample code	Campionario nr. Sample box n.
--------------------------------	----------------------------------

ND/NA

 Marmo ricomposto
Recomposed marble

 Rosso vino Ral 3005
Red wine Ral 3005



ZIOQURAT
by Driade Lab
2020

Contenitori

Struttura in laminato. Versione floreale con vano a giorno colore ottanio, gambe noce oppure color ottanio e, solo per versione con cassettoni, nappine rosse o verde salvia. Versione geometrica bianco nero con vano a giorno rosso e, solo per versione con cassettoni, maniglia colore nero sagomata secondo decoro. Uso solo interno.

Cabinets

Laminate structure. Flower pattern version with open compartment in teal color, legs in walnut or in teal color and, only for the version with chest of drawers, tufts red or sage green color. Geometric version white/black with open compartment in red color and, only for version with chest of drawers, shaped black handle according to decoration. Indoor use only.

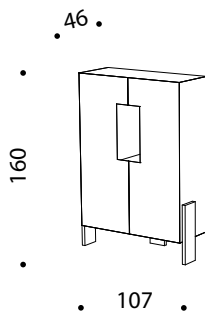

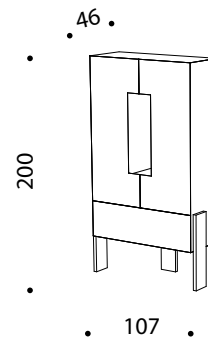

L.107 P.46 H.160
W.107 D.46 H.160



L.107 P.46 H.200
W.107 D.46 H.200

Struttura/Structure

Colore Color	Codice campione Sample code	Campionario nr. Sample box n.
 Laminato Floreale Floral decoration laminate	LAFLO12101	10
 Laminato Bianco/Nero White/Black laminate	LARIG12601	10

Gambe/Legs

Colore Color	Codice campione Sample code	Campionario nr. Sample box n.
 Impiallacciato Noce Canaletto lucido Glossy Canaletto Walnut veneer	LEINOF96L1	10
 MDF laccato Ottanio lucido Glossy Teal lacquered MDF	VERF58L1	6
 MDF laccato Nero Ral 9005 lucido Glossy Black Ral 9005 lacquered MDF	VER091L4	7

ZIQQURAT L.107 P.46 H.160/W.107 D.46 H.160



Codice
Code

D12252J122B49

Colore
Color

Prezzo Retail con Iva
Retail price with Vat

7.100,00

Campionario nr.
Sample box n.

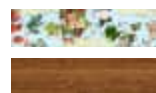

Laminato Floreale
Floral decoration laminate
Impiallacciato Noce Canaletto lucido
Glossy Canaletto Walnut veneer

ZIQQURAT L.107 P.46 H.200/W.107 D.46 H.200



Codice
Code

D12293J122B49

Colore
Color

Prezzo Retail con Iva
Retail price with Vat

8.100,00

Campionario nr.
Sample box n.

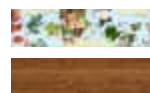

Laminato Floreale
Floral decoration laminate
Impiallacciato Noce Canaletto lucido
Glossy Canaletto Walnut veneer

ZIQQURAT L.107 P.46 H.160/W.107 D.46 H.160



Codice
Code

D12252J121B44

Colore
Color

Prezzo Retail con Iva
Retail price with Vat

7.100,00



Laminato Floreale
Floral decoration laminate
MDF laccato Ottanio lucido
Glossy Teal lacquered MDF

ZIQQURAT L.107 P.46 H.200/W.107 D.46 H.200



Codice
Code

D12293J121B44

Colore
Color

Prezzo Retail con Iva
Retail price with Vat

8.100,00



Laminato Floreale
Floral decoration laminate
MDF laccato Ottanio lucido
Glossy Teal lacquered MDF

ZIQQURAT L.107 P.46 H.160/W.107 D.46 H.160



Codice
Code

D12252J121E03

Colore
Color

Prezzo Retail con Iva
Retail price with Vat

7.190,00



Laminato Bianco/Nero
White/Black laminate
MDF laccato Nero Ral 9005 lucido
Glossy Black Ral 9005 lacquered MDF

ZIQQURAT L.107 P.46 H.200/W.107 D.46 H.200



Codice
Code

D12293J121E03

Colore
Color

Prezzo Retail con Iva
Retail price with Vat

8.100,00



Laminato Bianco/Nero
White/Black laminate
MDF laccato Nero Ral 9005 lucido
Glossy Black Ral 9005 lacquered MDF

ZIOQURAT
by Driade Lab
2020

Contenitori

Struttura in laminato, finitura esterna con decoro floreale, con grafica geometrica a righe, interno laccato nero con finitura texturizzata. Appoggio a terra con piedi in noce canaletto finitura lucida o laccati colo ottanio per versione floreale, laccati nero lucido per versione geometrica. Nella versione con decoro a righe i contenitori singoli sono stati previsti con i seguenti decori: Contenitore L 240 con decoro a righe bianco/nero, contenitore L 180 decoro a righe bianco/rosso, contenitore L 120 decoro a righe bianco/nero. Uso solo interno.

Cabinets

Laminate structure with external flower pattern, geometric graphic black/white, black lacquered inside part with textured finish. Canaletto Walnut feet with glossy finish or painted in teal color for flower pattern version, glossy black lacquered for geometric version black/white. The single boxes are available with the following decorations:

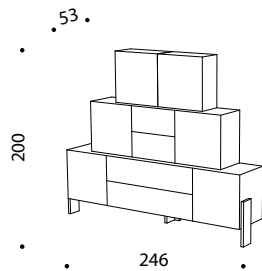

L. 246 P. 53 H. 200
W. 246 D. 53 H. 200

Contenitore L. 240 P.L. 176 Kg; V. 1,209 mc
Cabinet W. 240 G.W. 176 Kg; V. 1,209 cbm
Contenitore L. 180: P.L. 108 Kg; V. 0,77 mc
Cabinet W. 180: G.W. 108 Kg; V. 0,77 cbm
Contenitore L. 120: P.L. 57,3 Kg; V. 0,425 mc
Cabinet W. 120: G.W. 57,3 Kg; V. 0,425 cbm
Confezione appoggi a terra: P.L. 6,5 Kg; V. 0,03 mc
Ground supports: G.W. 6,5 Kg; V. 0,03 cbm

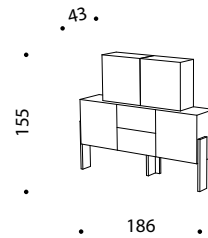

L. 186 P. 43 H. 155
W. 186 D. 43 H. 155

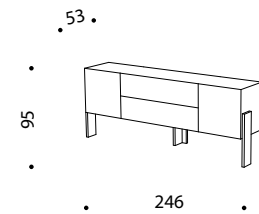

Contenitore L. 180: P.L. 108 Kg; V. 0,77 mc
Cabinet W. 180: G.W. 108 Kg; V. 0,77 cbm
Contenitore L. 120: P.L. 57,3 Kg; V. 0,425 mc
Cabinet W. 120: G.W. 57,3 Kg; V. 0,425 cbm
Confezione appoggi a terra: P.L. 8,3 Kg; V. 0,04 mc
Ground supports: G.W. 8,3 Kg; V. 0,04 cbm





L. 246 P. 53 H. 95
W. 246 D. 53 H. 95

Contenitore L. 240 P.L. 176 Kg; V. 1,209 mc
Cabinet W. 240 G.W. 176 Kg; V. 1,209 cbm
Confezione appoggi a terra: P.L. 8,3 Kg; V. 0,04 mc
Ground supports: G.W. 8,3 Kg; V. 0,04 cbm

Struttura/Structure

Colore Color	Codice campione Sample code	Campionario nr. Sample box n.
 Laminato Floreale Floral decoration laminate	LAFLO12101	10
 Laminato Bianco/Nero White/Black laminate	LARIG12601	10
 Laminato Bianco/Rosso White/Red laminate	LARIG12501	10

Gambe/Legs

Colore Color	Codice campione Sample code	Campionario nr. Sample box n.
 Impiallacciato Noce Canaletto lucido Glossy Canaletto Walnut veneer	LEINOF96L1	10
 MDF laccato Ottanio lucido Glossy Teal lacquered MDF	VERF58L1	6
 MDF laccato Nero Ral 9005 lucido Glossy Black Ral 9005 lacquered MDF	VER091L4	7

ZIQQURAT L.246 P.53 H.200/W.246 D.53 H.200



Codice
Code

D1185N2122B49

Colore
Color

Prezzo Retail con Iva
Retail price with Vat

16.100,00

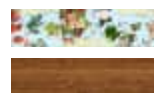

Laminato Floreale
Floral decoration laminate
Impiallacciato Noce Canaletto lucido
Glossy Canaletto Walnut veneer

ZIQQURAT L.186 P.43 H.155/W.186 D.43 H.155



Codice
Code

D11864J122B49

Colore
Color

Prezzo Retail con Iva
Retail price with Vat

8.850,00

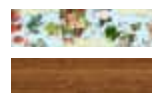

Laminato Floreale
Floral decoration laminate
Impiallacciato Noce Canaletto lucido
Glossy Canaletto Walnut veneer

ZIQQURAT L.246 P.53 H.200/W.246 D.53 H.200



Codice
Code

D1185N2121B44

Colore
Color

Prezzo Retail con Iva
Retail price with Vat

16.100,00



Laminato Floreale
Floral decoration laminate
MDF laccato Ottanio lucido
Glossy Teal lacquered MDF

ZIQQURAT L.186 P.43 H.155/W.186 D.43 H.155



Codice
Code

D11864J121B44

Colore
Color

Prezzo Retail con Iva
Retail price with Vat

8.850,00



Laminato Floreale
Floral decoration laminate
MDF laccato Ottanio lucido
Glossy Teal lacquered MDF

ZIQQURAT L.246 P.53 H.200/W.246 D.53 H.200



Codice
Code

D1185N2121E04

Colore
Color

Prezzo Retail con Iva
Retail price with Vat

16.250,00



Laminato Bianco/Nero
White/Black laminate
Laminato Bianco/Rosso
White/Red laminate
MDF laccato Nero Ral 9005 lucido
Glossy Black Ral 9005 lacquered MDF

ZIQQURAT L.186 P.43 H.155/W.186 D.43 H.155



Codice
Code

D11864J121E04

Colore
Color

Prezzo Retail con Iva
Retail price with Vat

8.850,00



Laminato Bianco/Nero
White/Black laminate
Laminato Bianco/Rosso
White/Red laminate
MDF laccato Nero Ral 9005 lucido
Glossy Black Ral 9005 lacquered MDF

ZIQQURAT L.246 P.53 H.95/W.246 D.53 H.95



Codice
Code

Colore
Color

Prezzo Retail con Iva
Retail price with Vat

D11874J122B49

7.8100,00



Laminato Floreale
Floral decoration laminate



Impiallacciato Noce Canaletto lucido
Glossy Canaletto Walnut veneer

ZIQQURAT L.246 P.53 H.95/W.246 D.53 H.95



Codice
Code

Colore
Color

Prezzo Retail con Iva
Retail price with Vat

D11874J121B44

7.810,00



Laminato Floreale
Floral decoration laminate



MDF laccato Ottanio lucido
Glossy Teal lacquered MDF

ZIQQURAT L.246 P.53 H.95/W.246 D.53 H.95



Codice
Code

Colore
Color

Prezzo Retail con Iva
Retail price with Vat

D11874J121E03

8.030,00



Laminato Bianco/Nero
White/Black laminate



MDF laccato Nero Ral 9005 lucido
Glossy Black Ral 9005 lacquered MDF

ZIOQURAT
by Driade Lab
2020

Contenitore

Struttura in laminato con finitura esterna con decoro floreale o con grafica geometrica bianco/nero o bianco/rosso, interno laccato nero con finitura texturizzata. Appoggio a terra con gambe altezza 65 cm. laccate nel colore ottanio lucido o in legno noce canaletto per la versione floreale e laccate nero lucido per la versione con grafica geometrica bianco/nero, o laccati rosso lucido per la versione con grafica geometrica bianco/rosso. Uso solo interno. L. 186 P. 43 H. 95

Cabinet

Laminate structure with external finish with floral decoration or with white/black or white/red geometric graphics, black lacquered interior with textured finish. Support on the ground with with legs height 53 cm. lacquered in glossy teal color, or in canaletto walnut for the floral version and glossy black lacquered for the version with white/black geometric graphic or glossy red lacquered for the version with white/red geometric graphic. Indoor use only. W. 186 D. 43 H. 95

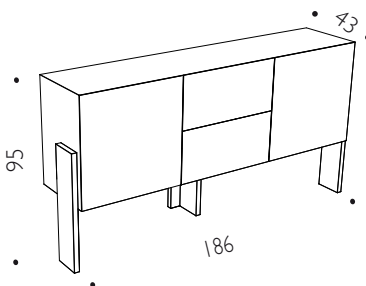



L. 186 P. 43 H. 95
W. 186 D. 43 H. 95

Struttura/Structure

Colore Color	Codice campione Sample code	Campionario nr. Sample box n.
 Laminato Floreale Floral decoration laminate	LAFLO12101	10
 Laminato Bianco/Nero White/Black laminate	LARIG12601	10
 Laminato Bianco/Rosso White/Red laminate	LARIG12501	10

Gambe/Legs

Colore Color	Codice campione Sample code	Campionario nr. Sample box n.
 Impiallacciato Noce Canaletto lucido Glossy Canaletto Walnut veneer	LEINOF96L1	10
 MDF laccato Ottanio lucido Glossy Teal lacquered MDF	VERF58L1	6
 MDF laccato Nero Ral 9005 lucido Glossy Black Ral 9005 lacquered MDF	VER091L4	7
 MDF laccato Rosso lucido Glossy Red lacquered MDF	VER039L6	6



Codice Code
D11893J122B49

Versione Version
Laminato Floreale
Floreale decoration laminate

Prezzo Retail con Iva
Retail price with Vat
6.000,00

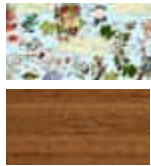

Impiallacciato Noce Canaletto lucido
Glossy Canaletto Walnut veneer



Codice Code
D11893J121B44

Versione Version
Laminato Floreale
Floreale decoration laminate

Prezzo Retail con Iva
Retail price with Vat
6.000,00



MDF laccato Ottanio lucido
Glossy Teal lacquered MDF



Codice Code
D11893J121E03

Versione Version
Laminato Bianco/Nero
White/Black laminate

Prezzo Retail con Iva
Retail price with Vat
6.250,00



MDF laccato Nero Ral 9005 lucido
Glossy Black Ral 9005 lacquered



Codice Code
D11893J121B55

Versione Version
Laminato Bianco/Rosso
White/Red laminate

Prezzo Retail con Iva
Retail price with Vat
6.250,00



MDF laccato Rosso lucido
Glossy Red lacquered MDF

LIBRERIE/*BOOKSHELVES*

TOTEM SHELF

by Big
2022**Espositore/Libreria**

Espositore / Libreria freestanding con un sistema girevole a terra per un comodo accesso a tutti i vari ripiani di appoggio disposti a vari livelli sui quattro lati dell'espositore. L'espositore è composto da elementi orizzontali e verticali in massello di rovere rigatino/mezza fiamma realizzati mediante l'unione di doghe dello spessore sottile di 10mm. con un bordo morbido arrotondato.

Display unit/Bookcase

Freestanding display unit/bookcase with a revolving floor system for convenient access to the shelves arranged on the four sides of the display unit. The display unit is composed of horizontal and vertical elements in solid ribbed/half-flame oak made by joining thin 10 mm thick staves with a soft rounded edge.



L. 75 P. 75 H. 208,3
W. 75 D. 75 H. 208,3

Codice
Code
D00099J025154

Colore
Color

Prezzo Retail con Iva
Retail price with Vat

11.000,00

Codice campione
Sample code

Campionario nr.
Sample box n.



Rovere rigatino
Ribbed oak



VENUS

by Fabio Novembre
2017**Libreria**

Libreria a cinque ripiani realizzata in rovere naturale effetto segato. Elementi di supporto dei ripiani in legno massello di rovere. Scultura in marmo ricomposto colore bianco. Uso solo interno.

Bookcase

Bookcase with five shelves in natural oak with sawn effect. Support elements in solid oak. Sculpture in recomposed marble in white color. Indoor use only.

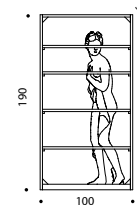

L. 100 P. 50 H. 190; P.L. 170 Kg; V. 1,089 mc
W. 100 D. 50 H. 190; G.W. 170 Kg; V. 1,089 cbm

Codice
Code
D10217J373177

Colore
Color

Prezzo Retail con Iva
Retail price with Vat

10.300,00

Codice campione
Sample code

Campionario nr.
Sample box n.



Marmo ricomposto
Recomposed marble



Legno Rovere segato
Sawn oak wood

LEIRO154S1

10



VIRGO

by Xavier Lust
2009

Libreria

Struttura e ripiani in alluminio anodizzato di colore nero. Uso solo interno.

Bookcase

Black anodised aluminum structure and shelves. Indoor use only.

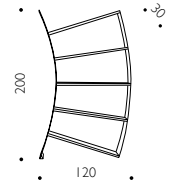

L. 120 P. 30 H. 200; P.L. 60 Kg; V. 0,95 mc
W. 120 D. 30 H. 200; G.W. 60 Kg; V. 0,95 cbm

Codice Code	Colore Color	Prezzo Retail con Iva Retail price with Vat
D00327J434091		5.150,00

Codice campione Sample code	Campionario nr. Sample box n.
ND/NA	

Alluminio anodizzato nero
Anodized black aluminum

ND/NA





ZIGZAG
 by Konstantin Grcic
2015
Libreria

Struttura e ripiani in acciaio verniciato a polveri epossidiche di colore bianco, nero, bronzo (con ripiani in rovere o noce canaletto). Reggilibri in lamiera di acciaio verniciato a polveri epossidiche disponibili nei colori: bianco, nero, arancio fluo, bronzo e acciaio inox lucidato a specchio. Confezione da quattro. NB: I reggilibri non sono compresi nel prezzo esposto. Il loro posizionamento è puramente indicativo. Uso solo interno.

Bookshelf

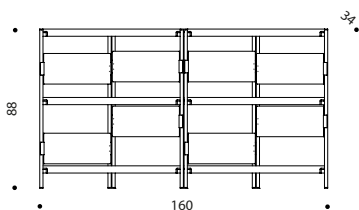
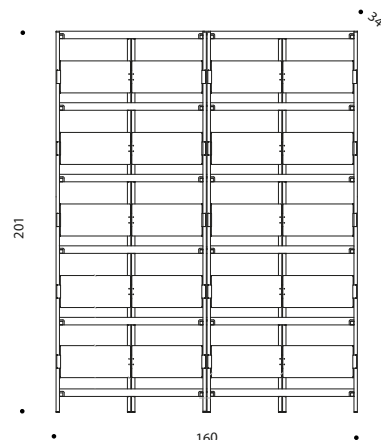
Structure and shelves in steel finished with epoxy paint in white and black, bronze (with shelves veneered in oak or Canaletto walnut). Bookends in sheet metal steel finished with epoxy paint available in the following colours: white, black, fluorescent orange, bronze, stainless steel polished to a mirror finish. Packed in 4 pieces. NB: The bookends are not included in the advertised price. Their placement is purely indicative. Indoor use only.

 L. 160 P. 34 H. 88
W. 160 D. 34 H. 88

 L. 160 P. 34 H. 201
W. 160 D. 34 H. 201
Struttura/Structure:

Colore Color	Codice campione Sample code	Campionario nr. Sample box n.
 Acciaio verniciato Bianco White painted Steel	VER002L1	6
 Acciaio vern. Nero Ral 9005 opaco Matt Black Ral 9005 painted Steel	VER091O3	7
 Acciaio verniciato Bronzo Bronze painted Steel	VER122L1	6

Ripiani/Shelves:

Colore Color	Codice campione Sample code	Campionario nr. Sample box n.
 Acciaio verniciato Bianco White painted Steel	VER002L1	6
 Acciaio vern. Nero Ral 9005 opaco Matt Black Ral 9005 painted Steel	VER091O3	7
 Impiallacciato Noce Canaletto Canaletto Walnut veneer	LEMNOF96O1	10
 Impiallacciato Rovere Oak veneer	LEIRO154O1	10

Reggilibri/Bookends:

 Acciaio verniciato Bianco White painted Steel	VER002L1	6	 Acciaio verniciato Bronzo Bronze painted Steel	VER122L1	6
 Acciaio vern. Nero Ral 9005 opaco Matt Black Ral 9005 painted Steel	VER091O3	7	 Acciaio inox lucidato a specchio Mirror polished stainless steel	META95L1	7

Struttura: P.L. 11,1 Kg; V. 0,07 mc
Structure: G.W. 11,1 Kg; V. 0,07 cbm
Ripiani (1 conf.) P.L. 26,6 Kg; V. 0,150 mc
Shelves (1 packaging) G.W. 26,6 Kg; V. 0,150 cbm



Codice Code	Versione Version	Prezzo Retail con Iva Retail price with Vat
D00338J358002		1.820,00

	Acciaio verniciato Bianco White painted Steel
	Acciaio verniciato Bianco White painted Steel

Struttura: P.L. 11,1 Kg; V. 0,07 mc
Structure: G.W. 11,1 Kg; V. 0,07 cbm
Ripiani (1 conf.) P.L. 26,6 Kg; V. 0,150 mc
Shelves (1 packaging) G.W. 26,6 Kg; V. 0,150 cbm



Codice Code	Versione Version	Prezzo Retail con Iva Retail price with Vat
D00338J358091		1.820,00

	Acciaio vern. Nero Ral 9005 opaco Matt Black Ral 9005 painted Steel
	Acciaio vern. Nero Ral 9005 opaco Matt Black Ral 9005 painted Steel

Struttura: P.L. 11,1 Kg; V. 0,07 mc
Structure: G.W. 11,1 Kg; V. 0,07 cbm
Ripiani (1 conf.) P.L. 42 Kg; V. 0,150 mc
Shelves (1 packaging) G.W. 42 Kg; V. 0,150 cbm



Codice Code	Versione Version	Prezzo Retail con Iva Retail price with Vat
D00338J357B19		2.540,00

	Impiallacciato Noce Canaletto Canaletto Walnut veneer
	Acciaio verniciato Bronzo Bronze painted Steel

Struttura: P.L. 11,1 Kg; V. 0,07 mc
Structure: G.W. 11,1 Kg; V. 0,07 cbm
Ripiani (1 conf.) P.L. 42 Kg; V. 0,150 mc
Shelves (1 packaging) G.W. 42 Kg; V. 0,150 cbm



Codice Code	Versione Version	Prezzo Retail con Iva Retail price with Vat
D00338J438B19		2.400,00

	Impiallacciato Rovere Oak veneer
	Acciaio verniciato Bronzo Bronze painted Steel

L. 37,5 P. 32 H. 17
W. 37,5 D. 32 H. 17
P.L. 5,5 Kg; V. 0,035 mc
G.W. 5,5 Kg; V. 0,035 cbm



Confezione da 4 pezzi per colore.
Packing: 4 pieces same color.

Codice Code	Versione Version	Prezzo Retail con Iva Retail price with Vat
-------------	------------------	---

D00310K358002		235,00
	Acciaio verniciato Bianco White painted Steel	
D00310K358091		235,00
	Acciaio vern. Nero Ral 9005 opaco Matt Black Ral 9005 painted Steel	
D00310K358122		235,00
	Acciaio verniciato Bronzo Bronze painted Steel	
D00310K431A95		520,00
	Acciaio inox lucidato a specchio Mirror polished stainless steel	

Struttura: P.L. 24,5 Kg; V. 0,167 mc
Structure: G.W. 24,5 Kg; V. 0,167 cbm
Ripiani (2 conf.) P.L. 53,2 Kg; V. 0,300 mc
Shelves (2 packaging) G.W. 53,2 Kg; V. 0,300 cbm

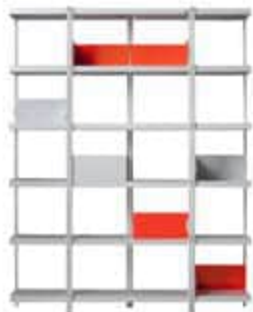

Codice Code	Versione Version	Prezzo Retail con Iva Retail price with Vat
D00339J358002		3.120,00

	Acciaio verniciato Bianco White painted Steel
	Acciaio verniciato Bianco White painted Steel

Struttura: P.L. 24,5 Kg; V. 0,167 mc
Structure: G.W. 24,5 Kg; V. 0,167 cbm
Ripiani (2 conf.) P.L. 53,2 Kg; V. 0,300 mc
Shelves (2 packaging) G.W. 53,2 Kg; V. 0,300 cbm

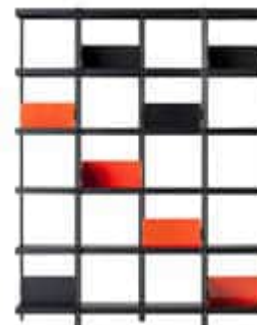

Codice Code	Versione Version	Prezzo Retail con Iva Retail price with Vat
D00339J358091		3.120,00

	Acciaio vern. Nero Ral 9005 opaco Matt Black Ral 9005 painted Steel
	Acciaio vern. Nero Ral 9005 opaco Matt Black Ral 9005 painted Steel

Struttura: P.L. 24,5 Kg; V. 0,167 mc
Structure: G.W. 24,5 Kg; V. 0,167 cbm
Ripiani (2 conf.) P.L. 84 Kg; V. 0,300 mc
Shelves (2 packaging) G.W. 84 Kg; V. 0,300 cbm



Codice Code	Versione Version	Prezzo Retail con Iva Retail price with Vat
D00339J357B19		4.570,00

	Impiallacciato Noce Canaletto Canaletto Walnut veneer
	Acciaio verniciato Bronzo Bronze painted Steel

Struttura: P.L. 24,5 Kg; V. 0,167 mc
Structure: G.W. 24,5 Kg; V. 0,167 cbm
Ripiani (2 conf.) P.L. 84 Kg; V. 0,300 mc
Shelves (2 packaging) G.W. 84 Kg; V. 0,300 cbm







Codice Code	Versione Version	Prezzo Retail con Iva Retail price with Vat
D00339J438B19		4.130,00

	Impiallacciato Rovere Oak veneer
	Acciaio verniciato Bronzo Bronze painted Steel

L. 37,5 P. 32 H. 17
 W. 37,5 D. 32 H. 17
 P.L. 5,5 Kg; V. 0,035 mc
 G.W. 5,5 Kg; V. 0,035 cbm

Confezione da 4 pezzi per colore.
 Packing: 4 pieces same color.

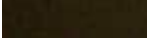

Codice Code	Versione Version	Prezzo Retail con Iva Retail price with Vat
D00310K358002		235,00
	Acciaio verniciato Bianco <i>White painted Steel</i>	
D00310K358091		235,00
	Acciaio vern. Nero Ral 9005 opaco <i>Matt Black Ral 9005 painted Steel</i>	
D00310K358122		235,00
	Acciaio verniciato Bronzo <i>Bronze painted Steel</i>	
D00310K431A95		520,00
	Acciaio inox lucidato a specchio <i>Mirror polished stainless steel</i>	

COMPLEMENTI D'ARREDO/ *FURNISHING*

ARCHIPELAGO

by Fredrikson Stallard
2015

Specchi

Taglio CNC, bisellatura, piastra in acciaio verniciato e pellicola antifrantumazione. Elementi decorativi in acciaio con finitura galvanica di colore oro. Uso solo interno.

Mirrors

CNC cut, bevelling, painted steel plate and non-crush film. Decorative items in steel, with a gold coloured galvanised finish. Indoor use only.

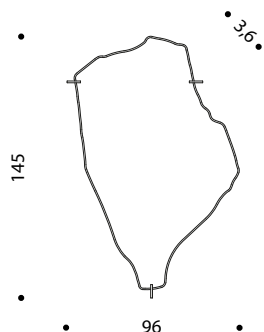

L. 96 P. 3,6 H. 145
W. 96 D. 3,6 H. 145
P.L. 28 Kg; V. 0,16 mc
G.W. 28 kg; V. 0,16 cbm

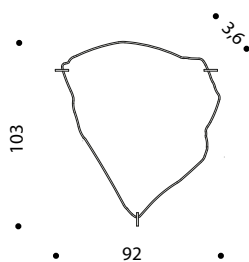

L. 92 P. 3,6 H. 103
W. 92 D. 3,6 H. 103
P.L. 21 Kg; V. 0,11 mc
G.W. 21 kg; V. 0,11 cbm

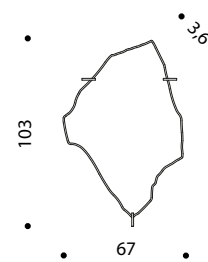

L. 67 P. 3,6 H. 103
W. 67 D. 3,6 H. 103
P.L. 16 Kg; V. 0,90 mc
G.W. 16 kg; V. 0,90 cbm

Struttura/Structure:

Colore
Color

Codice campione
Sample code

Campionario nr.
Sample box n.



Specchio
Mirror

ND/NA





Acciaio metallizzato oro
Metallized gold steel

ND/NA





Codice Code	Prezzo Retail con Iva Retail price with Vat	Codice campione Sample code	Campionario nr. Sample box n.
DA072I4444B66	1.970,00		
 Specchio Mirror		ND/NA	
 Acciaio metallizzato oro Metallized gold steel		ND/NA	



Codice Code	Prezzo Retail con Iva Retail price with Vat	Codice campione Sample code	Campionario nr. Sample box n.
DA071I3444B66	1.900,00		
 Specchio Mirror		ND/NA	
 Acciaio metallizzato oro Metallized gold steel		ND/NA	



Codice Code	Prezzo Retail con Iva Retail price with Vat	Codice campione Sample code	Campionario nr. Sample box n.
DA070I2444B66	1.680,00		
 Specchio Mirror		ND/NA	
 Acciaio metallizzato oro Metallized gold steel		ND/NA	

EDAIRD
by Marcelo Burlon
2022

Specchio

Specchio a muro realizzato mediante stratifica di uno specchio da 5mm. ed un vetro da 5mm. extrachiaro con stampa digitale sfumata. Lo specchio viene supportato da un pannello in mdf sp.18mm. verniciato nero opaco rientrante dal profilo perimetrale dello specchio, tutti gli spigoli sono arrotondati. Sistema di aggancio dello specchio al muro regolabile in altezza per un facile posizionamento e messa in bolla. Uso solo interno.

Mirror

Wall mirror made by layering a 5mm mirror and an extra-clear 5mm glass with shaded digital print. The mirror is supported by an 18mm. thick mdf panel painted matt black, recessed from the mirror perimeter profile. All edges are rounded. The mirror attachment system to the wall is adjustable in height for easy positioning and levelling.

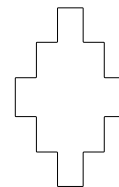

L. 92,5 H. 150; Sp.3; P.L. 35 Kg
W. 92,5 H. 150; Th.3; G.W. 35 Kg

Modello Model	Codice Code	Categoria materiale - Descrizione materiale Material category - Material description	Prezzo Retail con Iva Retail price with Vat
	D9106I3005G03	Vetro stampato Printed glass	1.700,00

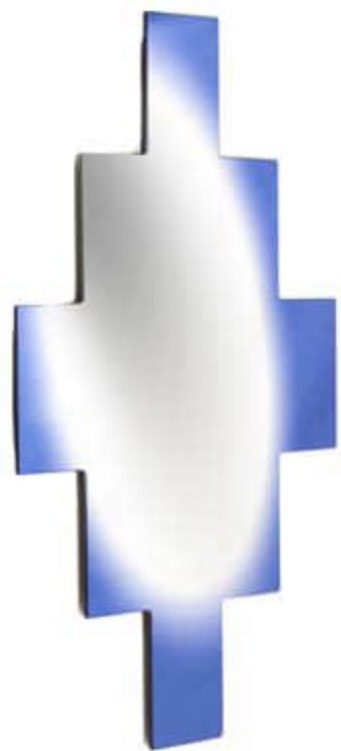

EGESO

by Bertocco & Locatelli
1991

Specchio

Specchio serigrafato in quadricromia con motivo di erbe campestri. Uso solo interno.

Mirror

Silkscreen printed wild herbs decorated mirror. Indoor use only.

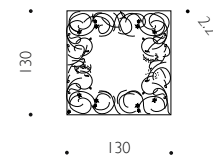

L. 130 P. 2,2 H. 130; P.L. 46 Kg; V. 0,156mc
W. 130 D. 2,2 H. 130; G.W. 46 Kg; V. 0,156cbm

Codice Code	Colore Color	Prezzo Retail con Iva Retail price with Vat
DE435I4017138		3.090,00

Codice campione Sample code	Campionario nr. Sample box n.
ND/NA	



Specchio serigrafato
Silkscreen printed mirror

ND/NA

OSMOND

by Pietro Derossi
1993

Specchio

Specchio con cornice in estruso di alluminio. Uso solo interno.

Mirror

Extruded aluminum framed mirror. Indoor use only.

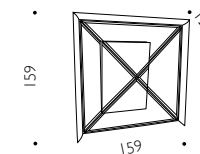

L. 159 P. 12 H. 159; P.L. 96 Kg; V. 0,606 mc
W. 159 D. 12 H. 159; G.W. 96 Kg; V. 0,606 cbm

Codice Code	Colore Color	Prezzo Retail con Iva Retail price with Vat
DO406I4016B67		5.390,00

Codice campione Sample code	Campionario nr. Sample box n.
ND/NA	



Specchio
Mirror

ND/NA



Alluminio Anodizzato
Anodized aluminum

ND/NA



SNIJDER BIRD

by Ed Annink
2005

Specchio
Specchio in acciaio inox lucidato. Uso solo interno.

Mirror
Polished stainless steel mirror. Indoor use only.



L. 69,4 P. 2 H. 47,5; P.L. 3,5 Kg; V. 0,030 mc
W. 69 D. 2 H. 47,5; G.W. 3,5 Kg; V. 0,030 cbm

Codice Code	Colore Color	Prezzo Retail con Iva Retail price with Vat
DS140I3431A95		490,00
	Codice campione Sample code	Campionario nr. Sample box n.



	Acciaio inox lucidato Polished stainless steel	META95L1	7
---	---	----------	---

TAYLOR BIRD

by Ed Annink
2005

Specchio
Specchio in acciaio inox lucidato. Uso solo interno.

Mirror
Polished stainless steel mirror. Indoor use only.

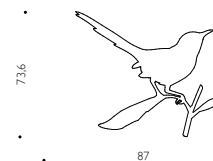

L. 87 P. 2 H. 73,6; P.L. 5 Kg; V. 0,050 mc
W. 87 D. 2 H. 73,6; G.W. 5 Kg; V. 0,050 cbm

Codice Code	Colore Color	Prezzo Retail con Iva Retail price with Vat
DT141I4431A95		680,00
	Codice campione Sample code	Campionario nr. Sample box n.



	Acciaio inox lucidato Polished stainless steel	META95L1	7
--	---	----------	---

MIRO
by Francesco Bolis
2013

Paravento/Specchio

Struttura costituita da tre pannelli in mdf, rivestiti da un lato in specchio extra-chiaro mm.5 argentato con stampa digitale, dall'altro in laminato nero. Uso solo interno.

Screen/Mirror

Structure consisting of three mdf panels, black laminated on the back side. The screen is coated on the front side with an extra-clear silver mirror covered with a digital image. Indoor use only.

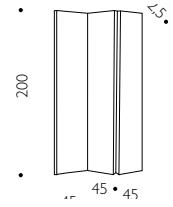

L. 135 P. 2,5 H. 200; P.L. 100 Kg; V. 0,31 mc
W. 135 D. 2,5 H. 200; G.W. 100 Kg; V. 0,31 cbm

Codice Code	Colore Color	Prezzo Retail con Iva Retail price with Vat
DM13515024C67		6.700,00

Codice campione Sample code	Campionario nr. Sample box n.
ND/NA	
ND/NA	



Specchio stampato
Printed mirror

ND/NA



Laminato nero
Black laminate

ND/NA

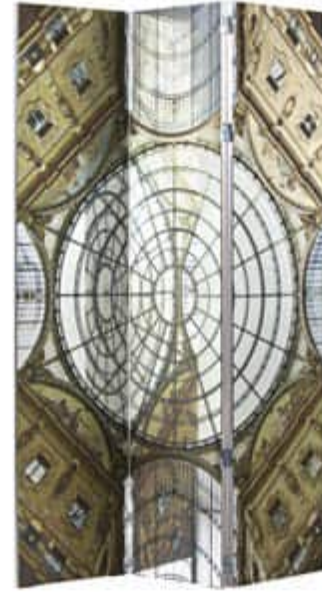

HANAHANA
by Kazuyo, Sejima
2000

Fioriera
Struttura e base in acciaio inox lucidato a specchio. Comprensiva di 19 ampolle portafiore in PVC estraibili. Uso solo interno.

Flower stand
Structure and base in mirrored polished stainless steel. The flower stand is equipped with 19 PVC removable ampoules. Indoor use only.

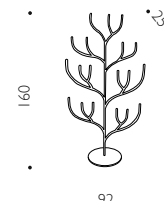

L. 92 P. 25 H. 160; P.L. 13 Kg; V. 0,434 mc
W. 92 D. 25 H. 180; G.W. 13 Kg; V. 0,434 cbm

Codice Code	Colore Color	Prezzo Retail con Iva Retail price with Vat
DH036J1431A95		1.100,00

Codice campione Sample code	Campionario nr. Sample box n.
META95L1	7

Acciaio inox lucidato a specchio
Mirror polished painted stainless

META95L1 7

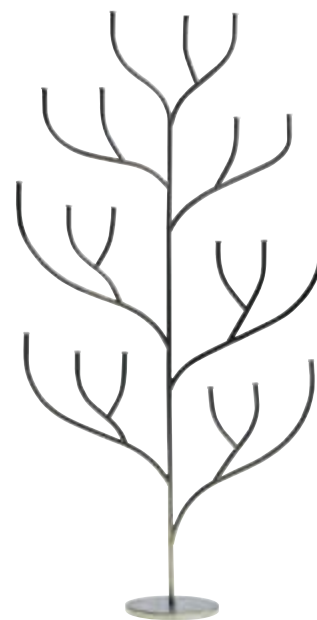

ACATE
by Borek Sipek
2007

Appendiabiti
Struttura in ottone opaco. Foglie in ottone lucido. Uso solo interno.

Coat hanger
Matt brass structure with polished brass leaves. Indoor use only.

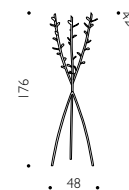

L. 48 P. 42 H. 178; P.L. 16 Kg; V. 0,564 mc
W. 48 D. 42 H. 178; G.W. 16 Kg; V. 0,564 cbm

Codice Code	Colore Color	Prezzo Retail con Iva Retail price with Vat
DA037K0008154		1.450,00

Codice campione Sample code	Campionario nr. Sample box n.
ND/NA	

Ottone
Brass

ND/NA



ERBALE

by Becchelli, Bortolani,
Maffei
1996

Fioriera

Elementi in plastica trasparente composti da quattro buste di contenimento per piante e di distribuzione acqua. Uso solo interno.

Plant holder

Transparent PVC plant holder equipped with 4 plants and 4 water bags. Indoor use only.

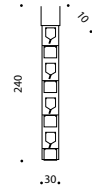

L. 30 P. 10 H. 240; P.L. 11,5 Kg; V. 0,102 mc
W. 30 D. 10 H. 240; G.W. 11,5 Kg; V. 0,102 cbm

Codice Code	Colore Color	Prezzo Retail con Iva Retail price with Vat
D11609M377001		215,00

Codice campione Sample code	Campionario nr. Sample box n.



PVC
PVC

ND/NA

**NEMO MINIATURA
FLOCCATA**

by Fabio Novembre
2022

Miniatura della poltrona Nemo





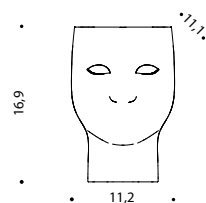

Nemo Miniatura floccage, è realizzata in ABS e successivamente impreziosita tramite un processo di floccatura. Al fondo è applicata a mano una targhetta in acciaio, che riporta logo, nome e designer, incisi a laser.

Nemo armchair in miniature

The flock-coated Nemo Miniature, is made of ABS and then enriched by a flocking process. A steel plate is hand-applied to the bottom, bearing a laser-engraved logo, name of the product and of the designer.



L. 11,2 P. 11,1 H. 16,9
W. 11,2 D. 11,1 H. 16,9
P.L. 0,20 Kg; V. 0,002 mc
G.W. 0,20 kg; V. 0,002 cbm

Colore Color	Codice campione Sample code	Campionario nr. Sample box n.	Colore Color	Codice campione Sample code	Campionario nr. Sample box n.
	ABS/Floccatura rossa ABS/Red Flock-Coated version	ND/NA		ABS/Floccatura turchese ABS/Turquoise Flock-Coated version	ND/NA
	ABS/Floccatura rosa ABS/Pink Flock-Coated version	ND/NA		ABS/Floccatura verde ABSGreen Flock-Coated version	ND/NA
	ABS/Floccatura gialla ABS/Yellow Flock-Coated version	ND/NA		ABS/Floccatura nera ABS/Black Flock-Coated version	ND/NA



Codice
Code

D43519K516039

Colore
Color

Rosso
Red

Prezzo Retail con Iva
Retail price with Vat

105,00



ABS/Floccatura rosso
ABS/Red Flock-Coated version



Codice
Code

D43519K516024

Colore
Color

Rosa
Pink

Prezzo Retail con Iva
Retail price with Vat

105,00



ABS/Floccatura rosa
ABS/Pink Flock-Coated version



Codice
Code

D43519K516021

Colore
Color

Giallo
Yellow

Prezzo Retail con Iva
Retail price with Vat

105,00



ABS/Floccatura
ABS/Flock-Coated version



Codice
Code

D43519K516G28

Colore
Color

Turchese
Turquoise

Prezzo Retail con Iva
Retail price with Vat

105,00



ABS/Floccatura
ABS/Flock-Coated version



Codice
Code

D43519K516063

Colore
Color

Verde
Green

Prezzo Retail con Iva
Retail price with Vat

105,00



ABS/Floccatura
ABS/Flock-Coated version



Codice
Code

D43519K516091

Colore
Color

Nero
Black

Prezzo Retail con Iva
Retail price with Vat

105,00



ABS/Floccatura
ABS/Flock-Coated version

NEMO MINIATURA

by Fabio Novembre
2017

Miniatura della poltrona Nemo

Miniatura di poltrona monoblocco in polietilene in scala 1:8 di colore bianco, nero, rosso o grigio oppure realizzata in abs nel colore metallizzato oro o argento. Uso interno/esterno.

Nemo armchair in miniature

The miniature of Nemo armchair, design by Fabio Novembre, a piece of furniture able to propose a mythic, abstract and universal beauty as occurred in greek art. Available in the colors white, black, red or grey or in ABS gold or silver version.

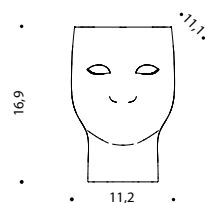

L. 11,2 P. 11,1 H. 16,9 / W. 11,2 D. 11,1 H. 16,9
P.L. 0,20 Kg; V. 0,002 mc
G.W. 0,20 kg; V. 0,002 cbm

Colore Color	Codice campione Sample code	Campionario nr. Sample box n.	Colore Color	Codice campione Sample code	Campionario nr. Sample box n.
 ABS metallizzato Oro Gold color ABS metallized	MET112L1	x	 Polietilene Nero Ral 9011 Black Ral 9011 Polyethylene	PLA091O2	x
 ABS metallizzato Argento Silver color ABS metallized	MET043L1	6	 Polietilene Grigio Pantone 7537U Grey Pantone 7537U Polyethylene	PLA044O1	x
 Polietilene Bianco Ral 9016 White Ral 9016 Polyethylene	PLA002O2	x	 Polietilene Rosso Pantone 1797C Red Pantone 1797C Polyethylene	PLA039O1	x



Codice
Code

Colore
Color

D43519K376112

Oro
Gold

Prezzo Retail con Iva
Retail price with Vat

105,00



ABS metallizzato
ABS metallized



Codice
Code

Colore
Color

D43519K376043

Argento
Silver

Prezzo Retail con Iva
Retail price with Vat

105,00



ABS metallizzato
ABS metallized



Codice
Code

Colore
Color

D43519K278002

Bianco Ral 9016
White Ral 9016

Prezzo Retail con Iva
Retail price with Vat

57,00



Polietilene
Polyethylene



Codice
Code

Colore
Color

D43519K278091

Nero Ral 9011
Black Ral 9011

Prezzo Retail con Iva
Retail price with Vat

57,00



Polietilene
Polyethylene



Codice
Code

Colore
Color

D43519K278044

Grigio Pantone 7537U
Grey Pantone 7537U

Prezzo Retail con Iva
Retail price with Vat

57,00



Polietilene
Polyethylene



Codice
Code

Colore
Color

D43519K278039

Rosso Pantone 1797C
Red Pantone 1797C

Prezzo Retail con Iva
Retail price with Vat

57,00



Polietilene
Polyethylene

WELCOME
by Fabio Novembre
2023

Lampada da tavolo



Lampada portatile con luce diretta a LED, utilizzabile anche come centrotavola. Realizzata in materiale plastico ABS colorato in massa, il diffusore è in PMMA trasparente opalino. Disponibile nei colori bianco, nero e rosso porpora. Un pulsante touch trasparente permette l'accensione, lo spegnimento e la regolazione dell'intensità della luce oltre ad indicare il livello di carica. La lampada è alimentata da una batteria della durata di 8 ore e ricaricabile mediante cavo con presa USB. Uso interno/esterno. Made in Italy.

Table lamp

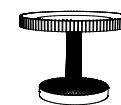
Portable lamp with direct LED light also to be used as a centrepiece. Made of mass-coloured ABS plastic, the diffuser is of transparent opal PMMA. Available in white, black and purple red. A transparent touch button allows switching on and off and adjusting the light intensity as well as indicating the charge level. The lamp is powered by an 8hour battery and rechargeable via cable with USB socket. Indoor/outdoor use. Made in Italy.







Dia. 23 H. 17,6; PL. 1,5Kg.
Dia 23 H. 17,6; G.W. 1,5 Kg.

Modello Model	Codice Code	Categoria materiale - Descrizione materiale Material category - Material description	Prezzo Retail con Iva Retail price with Vat
Outdoor IP54 Lcd: 1.5 W / lumen: 220lm / Kelvin: 2700K 	D91114L648002	ABS Bianco Ral 9016 ABS White Ral 9016	200,00
Outdoor IP54 Lcd: 1.5 W / lumen: 220lm / Kelvin: 2700K 	D91114L648039	ABS Rosso Ral 3004 ABS Red Ral 3004	200,00
Outdoor IP54 Lcd: 1.5 W / lumen: 220lm / Kelvin: 2700K 	D91114L648091	ABS Nero Ral 9005 ABS Black Ral 9005	200,00

PIU'DIUNO
by Omar Hassan
2022

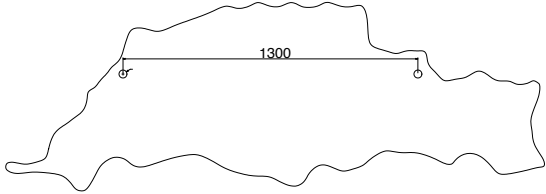
Arazzo
Arazzo in lana di 11 colori con fili "taftato a mano". Uso solo interno.

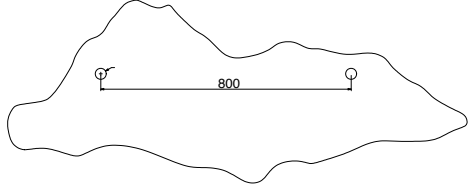
Tapestry
Wool tapestry in 11 colours with 'hand-tafted' threads. Indoor use only.

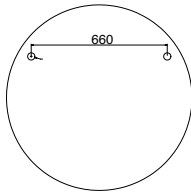
Modello Model	Codice Code	Categoria materiale - Descrizione materiale Material category - Material description	Prezzo Retail con Iva Retail price with Vat
<p>L. 255 H. 103 + frange pendenti 140 cm P.L. 94 Kg. W. 255 H. 103 + pending fringes 140 cm G.W. 94 Kg.</p> 	D91096L378138	<p>Lana Wool</p> <p>SISTEMA REGOLABILE DI AGGANCIO A PARETE ADJUSTABLE WALL MOUNTING SYSTEM</p> 	5.000,00
<p>L. 165 H. 70 + frange pendenti 140 cm P.L. 41 Kg. W. 165 H. 70 + pending fringes 140 cm G.W. 41 Kg.</p> 	D91095L378138	<p>Lana Wool</p> <p>SISTEMA REGOLABILE DI AGGANCIO A PARETE ADJUSTABLE WALL MOUNTING SYSTEM</p> 	2.400,00
<p>Dia. 100 + frange pendenti 140 cm P.L. 18 Kg. Dia. 100 + pending fringes 140 cm G.W. 18 kg.</p> 	D91095Z378138	<p>Lana Wool</p> <p>SISTEMA REGOLABILE DI AGGANCIO A PARETE ADJUSTABLE WALL MOUNTING SYSTEM</p> 	2.100,00

LISTINO PREZZI 2023
PRICE LIST 2023

OUTDOOR

BO
by Philippe Starck
2002

Sedia impilabile (max 8 pezzi)

Monoblocco in polipropilene disponibile nei colori: bianco, senape, cipria o grigio.

Confezione da quattro pezzi per colore. Uso interno/esterno.

Stackable chair (max 8 pcs)

Polypropylene monobloc available in: white, mustard yellow, carnation or grey color.

Packing unit: four pieces same colour Indoor/outdoor use.

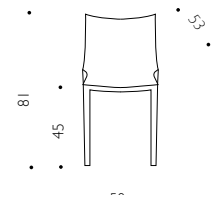

L. 50 P. 53 H. 81; seduta H. 45; P.L. 21 Kg; V. 0,407 mc
W. 50 D. 53 H. 81; seat H. 45; G.W. 21 Kg; V. 0,407 cbm



Codice
Code
D18034A379002

Prezzo Retail con Iva
Retail price with Vat

175,00

Codice campione
Sample code
Campionario nr.
Sample box n.



Polipropilene Bianco Ral 9016
Polypropylene White Ral 9016

PLA002O2

5



Codice
Code
D18034A379020

Prezzo Retail con Iva
Retail price with Vat

175,00

Codice campione
Sample code
Campionario nr.
Sample box n.



Polipropilene Senape Dic C146
Polypropylene Mustard Dic C146

PLA020O1

5



Codice
Code
D18034A379017

Prezzo Retail con Iva
Retail price with Vat

175,00

Codice campione
Sample code
Campionario nr.
Sample box n.



Polipropilene Cipria Dic C104
Polypropylene Carnation Dic C104

PLA017O1

5



Codice
Code
D18034A379044

Prezzo Retail con Iva
Retail price with Vat

175,00

Codice campione
Sample code
Campionario nr.
Sample box n.



Polipropilene GR. Pantone Cool Gray 3U
Polypropylene Grey Pantone
Cool Grey 3U

PLA044O3

5

CLOVER
by Ron Arad
2007

Poltroncina

Monoblocco in polietilene disponibile nei colori bianco e nero antracite. Uso interno/esterno.

Armchair

Polyethylene monobloc available in the colors white and black anthracite. Indoor/outdoor use.

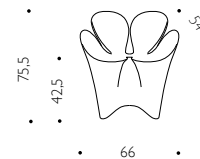

L. 66 P. 54 H. 75,5; seduta H. 42,5; PL. 14 Kg; V. 0,323 mc
W. 66 D. 54 H. 75,5; seat H. 42,5; G.W. 14 Kg; V. 0,323 cbm



Codice Code
D43614A278002

Prezzo Retail con Iva Retail price with Vat
510,00

Codice campione Sample code
PLA002O4

Campionario nr. Sample box n.
5



Polietilene Bianco Ral 9010
White Ral 9010 polyethylene

Codice Code
D43614A278057

Prezzo Retail con Iva Retail price with Vat
510,00

Codice campione Sample code
PLA091O5

Campionario nr. Sample box n.
5



Polietilene Nero antracite Ral 7016
Anthracite Black Ral 9010 polyethylene

LORD YO
by Philippe Starck
1994

Sedia

Struttura in alluminio. scocca in polipropilene disponibile nei colori: bianco, nero, cipria, grigio chiaro. **Confezione da quattro pezzi per colore.** Uso interno/esterno.

Chair

Aluminum structure. polypropylene shell available in: white, black, carnation, light grey.

Packing unit: four pieces same colour Indoor/outdoor use.

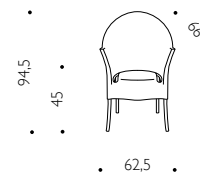

L. 62,5 P. 66 H. 94,5; seduta H. 45; P.L. 29 Kg; V. 0,668 mc
W. 62,5 D. 66 H. 94,5; seat H. 45; G.W. 29 Kg; V. 0,668 cbm



Codice
Code
D16294A380531

Prezzo Retail con Iva
Retail price with Vat

265,00

Codice campione
Sample code
Campionario nr.
Sample box n.



Polipropilene Bianco Ral 9016
White Ral 9016 Polypropylene

PLA002O2

5



Codice
Code
D16294A380561

Prezzo Retail con Iva
Retail price with Vat

265,00

Codice campione
Sample code
Campionario nr.
Sample box n.



Polipropilene Nero
antracite Ral 9004
Anthracite Black Ral 9004
Polypropylene

PLA091O3

5



Codice
Code
D16294A380539

Prezzo Retail con Iva
Retail price with Vat

265,00

Codice campione
Sample code
Campionario nr.
Sample box n.



Polipropilene Cipria Dic -C104
Carnation Dic -C104 Polypropylene

PLA017O1

5



Codice
Code
D16294A380550

Prezzo Retail con Iva
Retail price with Vat

265,00

Codice campione
Sample code
Campionario nr.
Sample box n.



Polipropilene Grigio chiaro
Pantone Warm Grey 4U
Light Gray Pantone Warm Gray 4U
Polypropylene

PLA045O1

5

LORD YO
by Philippe Starck
1994

Rivestimento
Rivestimento in cotone bianco. **Confezione da quattro pezzi.**

Coiver
Loose cover in white cotton. **Packing unit: four pieces.**



Codice
Code

D16500N428002

Prezzo Retail con Iva
Retail price with Vat

175,00

Codice campione
Sample code

Campionario nr.
Sample box n.

ND/NA



Cotone
Cotton

PIP-e
by Philippe Starck with
Eugeni Quitllet
2010

Sedia
Monoblocco in polipropilene di colore bianco, grigio scuro, cipria o grigio lavanda.
Confezione da quattro pezzi per colore. Uso interno/esterno.

Chair
White, dark grey, carnation or lavender grey polypropylene monobloc. **Packing unit:**
four pieces same colour Indoor/outdoor use.

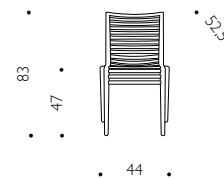

L. 44 P. 52,5 H. 83; seduta H. 47; P.L. 16 Kg; V. 0,37 mc
W. 44 D. 52,5 H. 83; seat H. 47; G.W. 16 Kg; V. 0,37 cbm



Codice Code	Prezzo Retail con Iva Retail price with Vat
D51141A379002	175,00

Codice campione Sample code	Campionario nr. Sample box n.
--------------------------------	----------------------------------



Polipropilene Bianco RAL 9001
White Ral 9001 Polypropylene

PLA00203	5
----------	---

D51141A475002	175,00
---------------	--------



Polipropilene Bianco RAL 9001
White Ral 9001 Polypropylene

PLA00203	5
----------	---



Codice Code	Prezzo Retail con Iva Retail price with Vat
D51141A379050	175,00

Codice campione Sample code	Campionario nr. Sample box n.
--------------------------------	----------------------------------



Polipropilene Grigio scuro Pantone 446U
Dark Grey Pantone 446U Polypropylene

PLA05001	5
----------	---

D51141A475050	175,00
---------------	--------



Polipropilene Grigio scuro Pantone 446U
Dark Grey Pantone 446U Polypropylene

PLA05001	5
----------	---



Codice Code	Prezzo Retail con Iva Retail price with Vat
D51141A379017	175,00

Codice campione Sample code	Campionario nr. Sample box n.
--------------------------------	----------------------------------



Polipropilene Cipria Dic C104
Carnation Dic C104 Polypropylene

PLA01701	5
----------	---



Codice Code	Prezzo Retail con Iva Retail price with Vat
D51141A379055	175,00

Codice campione Sample code	Campionario nr. Sample box n.
--------------------------------	----------------------------------



Polipropilene Grigio lavanda DIC-C285
Lavender Grey DIC-C285 Polypropylene

PLA05501	5
----------	---

PIP-e
by Philippe Starck
2007

Poltroncina
Monoblocco in polipropilene di colore bianco, grigio scuro, cipria o grigio lavanda.
Confezione da quattro pezzi per colore. Uso interno/esterno.

Armchair
White, dark grey, carnation or lavender grey polypropylene monobloc. **Packing unit: four pieces same colour** Indoor/outdoor use.

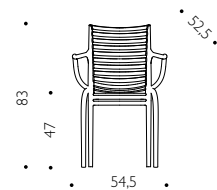

L. 54,5 P. 52,5 H. 83; seduta H. 47; P.L. 19 Kg; V. 0,44 mc
W. 54,5 D. 52,5 H. 83; seat H. 47; G.W. 19 Kg; V. 0,44 cbm



Codice Code	Prezzo Retail con Iva Retail price with Vat
D20844A379002	230,00

Codice campione Sample code	Campionario nr. Sample box n.
PLA002O3	5

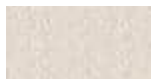

Polipropilene Bianco RAL 9001
White Ral 9001 Polypropylene

D20844A475002	230,00
---------------	--------



Polipropilene Bianco RAL 9001
White Ral 9001 Polypropylene

PLA002O3	5
----------	---



Codice Code	Prezzo Retail con Iva Retail price with Vat
D20844A379050	230,00

Codice campione Sample code	Campionario nr. Sample box n.
PLA050O1	5



Polipropilene Grigio scuro Pantone 446U
Dark Grey Pantone 446U Polypropylene

D20844A475050	230,00
---------------	--------



Polipropilene Grigio scuro Pantone 446U
Dark Grey Pantone 446U Polypropylene

PLA050O1	5
----------	---



Codice Code	Prezzo Retail con Iva Retail price with Vat
D20844A379017	230,00

Codice campione Sample code	Campionario nr. Sample box n.
PLA017O1	5



Polipropilene Cipria Dic C104
Carnation Dic C104 Polypropylene



Codice Code	Prezzo Retail con Iva Retail price with Vat
D20844A379055	230,00

Codice campione Sample code	Campionario nr. Sample box n.
PLA055O1	5



Polipropilene Grigio lavanda DIC-C285
Lavender Grey DIC-C285 Polypropylene

SISSI
by Ludovica + Roberto
Palomba
2017

Sedia
Monoblocco in polipropilene copolimero con fibra di vetro, piedini in polietilene semimorbido naturale. Impilabile a quattro pezzi. Disponibile nei colori: bianco, grigio scuro, rosa, verde o rosso. **Confezione da quattro pezzi per colore.**
Usa interno/esterno.

Chair
Monobloc in polypropylene copolymer with glass fiber, natural polyethylene semisoft feet. Stackable up of four pieces. Available in the colors white, dark grey, pink, green or red. **Boxes of four pieces of the same color.** Indoor/outdoor use.

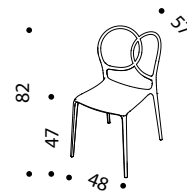

L. 48 P. 57 H. 83; seduta H. 47 ; P.L. 17 Kg; V. 0,397 mc
W. 48 D. 57,5 H. 83; seat H. 47; G.W. 17Kg; V. 0,397 cbm



Codice
Code
D51531A379002

Prezzo Retail con Iva
Retail price with Vat
170,00

Codice campione
Sample code
Campionario nr.
Sample box n.



Polipropilene Bianco RAL 9001
White Ral 9001 Polypropylene

PLA002O3

5



Codice
Code
D51531A475002

Prezzo Retail con Iva
Retail price with Vat
170,00

Codice campione
Sample code
Campionario nr.
Sample box n.



Polipropilene riciclato
Bianco RAL 9001
White Ral 9001 Recycled polyp.

PLA002O3

5



Codice
Code
D51531A379050

Prezzo Retail con Iva
Retail price with Vat
170,00

Codice campione
Sample code
Campionario nr.
Sample box n.



Polipropilene Grigio scuro
Pantone 446U
Dark Grey Pantone 446U
Polypropylene

PLA050O1

5



Codice
Code
D51531A475050

Prezzo Retail con Iva
Retail price with Vat
170,00

Codice campione
Sample code
Campionario nr.
Sample box n.



Polipropilene riciclato Grigio scuro
Pantone 446U
Dark Grey Pantone 446U Recycled
polypropylene

PLA050O1

5

SISSI
by Ludovica + Roberto
Palomba
2017

Sedia
Monoblocco in polipropilene copolimero con fibra di vetro, piedini in polietilene semimorbido naturale. Impilabile a quattro pezzi. Disponibile nei colori: bianco, grigio scuro, rosa, verde o rosso. **Confezione da quattro pezzi per colore.**
Usa interno/esterno.

Chair
Monobloc in polypropylene copolymer with glass fiber, natural polyethylene semisoft feet. Stackable up of four pieces. Available in the colors white, dark grey, pink, green or red. **Boxes of four pieces of the same color.** Indoor/outdoor use.

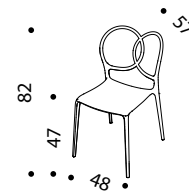

L. 48 P. 57 H. 83; seduta H. 47 ; P.L. 17 Kg; V. 0,397 mc
W. 48 D. 57,5 H. 83; seat H. 47 ; G.W. 17Kg; V. 0,397 cbm



Codice
Code
D51531A379024

Prezzo Retail con Iva
Retail price with Vat
170,00

Codice campione
Sample code
Campionario nr.
Sample box n.



Polipropilene Rosa Pantone 7514C
Pink Pantone 7514C Polypropylene

PLA02401

5



Codice
Code
D51531A379063

Prezzo Retail con Iva
Retail price with Vat
170,00

Codice campione
Sample code
Campionario nr.
Sample box n.



Polipropilene Verde Pantone 7494C
Green Pantone 7494C Polypropylene

PLA06301

5



Codice
Code
D51531A379039

Prezzo Retail con Iva
Retail price with Vat
170,00

Codice campione
Sample code
Campionario nr.
Sample box n.



Polipropilene Rosso Pantone 1807C
Red Pantone 1807C Polypropylene

PLA03902

5

SISSI
by Ludovica + Roberto
Palomba
2017

Poltroncina
Monoblocco in polipropilene copolimero con fibra di vetro, piedini in polietilene semimorbido naturale. Impilabile a quattro pezzi. Disponibile nei colori: bianco, grigio scuro, rosa, verde o rosso. **Confezione da quattro pezzi per colore.**
Usa interno/esterno.

Armchair
Monobloc in polypropylene copolymer with glass fiber, natural polyethylene semisoft feet. Stackable up of four pieces. Available in the colors white, dark grey, pink, green or red. **Boxes of four pieces of the same color.** Indoor/outdoor use.

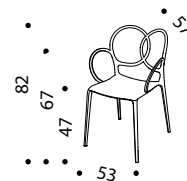

L. 53 P. 57 H. 83; seduta H. 47; bracciolo H. 68;
P.L. 22 Kg; V. 0,400 mc
W. 53 D. 57 H. 83; seat H. 47; armrest H. 68;
G.W. 22 Kg; V. 0,400 cbm



Codice Code
D51634A379002
Prezzo Retail con Iva Retail price with Vat
210,00

Codice campione Sample code
Campionario nr. Sample box n.



Polipropilene Bianco RAL 9001
White Ral 9001 Polypropylene

PLA002O3 5

Codice Code
D51634A475002
Prezzo Retail con Iva Retail price with Vat
210,00

Codice campione Sample code
Campionario nr. Sample box n.



Polipropilene riciclato
Bianco RAL 9001
White Ral 9001 Recycled polyp.

PLA002O3 5



Codice Code
D51634A379050
Prezzo Retail con Iva Retail price with Vat
210,00

Codice campione Sample code
Campionario nr. Sample box n.



Polipropilene Grigio scuro
Pantone 446U
Dark Grey Pantone 446U
Polypropylene

PLA050O1 5

Codice Code
D51634A475050
Prezzo Retail con Iva Retail price with Vat
210,00

Codice campione Sample code
Campionario nr. Sample box n.



Polipropilene riciclato Grigio scuro
Pantone 446U
Dark Grey Pantone 446U Recycled
polypropylene

PLA050O1 5

SISSI
by Ludovica + Roberto
Palomba
2017

Poltroncina

Monoblocco in polipropilene copolimero con fibra di vetro, piedini in polietilene semimorbido naturale. Impilabile a quattro pezzi. Disponibile nei colori: bianco, grigio scuro, rosa, verde o rosso. **Confezione da quattro pezzi per colore.**

Usò interno/esterno.

Armchair

Monobloc in polypropylene copolymer with glass fiber, natural polyethylene semisoft feet. Stackable up of four pieces. Available in the colors white, dark grey, pink, green or red. **Boxes of four pieces of the same color.** Indoor/outdoor use.

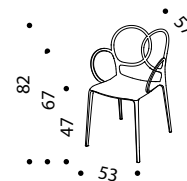

L. 53 P. 57 H. 83; seduta H. 47; bracciolo H. 68;
P.L. 22 Kg; V. 0,400 mc
W. 53 D. 57 H. 83; seat H. 47; armrest H. 68;
G.W. 22 Kg; V. 0,400 cbm



Codice
Code

Prezzo Retail con Iva
Retail price with Vat

D51634A379024

210,00

Codice campione
Sample code

Campionario nr.
Sample box n.



Polipropilene Rosa Pantone 7514C
Pink Pantone 7514C Polypropylene

PLA02401

5



Codice
Code

Prezzo Retail con Iva
Retail price with Vat

D51634A379063

210,00

Codice campione
Sample code

Campionario nr.
Sample box n.



Polipropilene Verde Pantone 7494C
Green Pantone 7494C Polypropylene

PLA06301

5



Codice
Code

Prezzo Retail con Iva
Retail price with Vat

D51634A379039

210,00

Codice campione
Sample code

Campionario nr.
Sample box n.



Polipropilene Rosso Pantone 1807C
Red Pantone 1807C Polypropylene

PLA03902

5

SOF SOF OUTDOOR

by Enzo Mari
1972-2015

Sedia

Struttura in acciaio con trattamento protettivo di cataforesi verniciato a polveri poliestere; cuscini mobili in schiume poliuretatiche. Rivestimento in tessuto per outdoor. Uso interno/esterno.

Chair

Structure in steel rod with protective cataphoresis treatment finished in graphite gray colour polyester paint; removable cushions in polyurethane foam. Fabric cover for outdoor. Indoor/outdoor use.

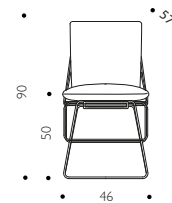

L 46 P. 57 H. 90; seduta H. 50; P.L. 8,6 Kg; V. 0,287 mc
W. 46 D. 57 H. 90; seat H. 50; G.W. 8,6 Kg; V. 0,287 cbm

Modello Model	Codice Code	Categoria materiale - Descrizione materiale Material category - Material description	Prezzo Retail con Iva Retail price with Vat
	D25001A381	Acrilico Cipro/Acciaio vern.cataforesi Acrylic Cipro/Cataphoresis painted steel	980,00
	D25001A382	Polipropilene Pantelleria/Acciaio vern.cataforesi Polypropylene Pantelleria/Cataphoresis painted steel	

PER LA SCELTA DELLA SCOCCA, TESSUTI E PELLI
CONSULTARE IL LIBRO "ABBINAMENTO TESSUTI-PELLI/
MATERIALI"

FOR THE CHOICE OF SHELL, FABRICS AND LEATHERS,
SEE BOOK "MATCHING FABRICS-LEATHERS/
MATERIALS"



Codice campione
Sample code

ND/NA

Campionario nr.
Sample box n.

TOY
by Philippe Starck
1999

Poltroncina impilabile

Monoblocco in polipropilene disponibile nei colori: bianco, nero, cipria, senape o grigio chiaro. **Confezione da quattro pezzi per colore.** Uso interno/esterno.

Stackable armchair

Polypropylene monobloc available in these colors: white, black, carnation, mustard yellow or, light grey. **Packing unit: four pieces same colour** Indoor/outdoor use.

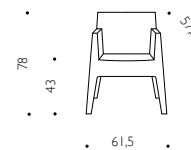

L. 61,5 P. 57,5 H. 78; seduta H. 43; braccioli H. 64,5;
P.L. 34 Kg; V. 0,430 mc
W. 61,5 D. 57,5 H. 78; seat H. 43 armrest H. 64,5;
G.W. 34 Kg; V. 0,430 cbm



Codice
Code
D29864A379002

Prezzo Retail con Iva
Retail price with Vat

230,00

Codice campione
Sample code
Campionario nr.
Sample box n.



Polipropilene Bianco Ral 9016
White Ral 9016 Polypropylene

PLA002O2

5



Codice
Code
D29864A379091

Prezzo Retail con Iva
Retail price with Vat

230,00

Codice campione
Sample code
Campionario nr.
Sample box n.



Polipropilene Nero
antracite Ral 7016
Anthracite Black Ral
9010 Polypropylene

PLA091O3

5



Codice
Code
D29864A379017

Prezzo Retail con Iva
Retail price with Vat

230,00

Codice campione
Sample code
Campionario nr.
Sample box n.



Polipropilene Cipria Dic -C104
Carnation Dic -C104 Polypropylene

PLA017O1

5



Codice
Code
D29864A379020

Prezzo Retail con Iva
Retail price with Vat

230,00

Codice campione
Sample code
Campionario nr.
Sample box n.



Polipropilene Senape Dic C146
Mustard Dic C146 Polypropylene

PLA020O1

5

TOY
by Philippe Starck
1999

Rivestimento
Rivestimento in cotone bianco. **Confezione da quattro pezzi.**

Coiver
Loose cover in white cotton. **Packing unit: four pieces.**



Codice
Code
D29864A379045

Prezzo Retail con Iva
Retail price with Vat

230,00

Codice campione
Sample code
Campionario nr.
Sample box n.



Polipropilene Grigio ch.
Pantone Warm Gray 4U
Light grey Pantone Warm gray
4U Polypropylene

PLA04501

5

Codice
Code
D29510N428002

Prezzo Retail con Iva
Retail price with Vat

175,00

Codice campione
Sample code
Campionario nr.
Sample box n.



Cotone
Cotton

ND/NA

**POUF/
*OTTOMAN***



ARCAD3
by Pow3r
2022
Pouf/Contentitore

Pouf realizzato in due parti separabili tra loro per consentire l'accesso al contenimento ricavato nella base di appoggio a terra. La seduta è realizzata in poliuretano integrale morbido colorato in massa nelle varianti nero, rosso e blu. La base di appoggio è realizzata in polietilene colorato in massa nelle varianti nero, rosso e blu. Possibilità di aggiungere alla base di appoggio delle ruote pivotanti per spostare facilmente il pouf. Uso interno/esterno.

Pouf/Container

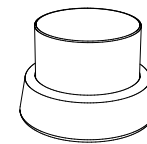
Pouf made in two parts that can be separated from each other to allow access to the storage compartment in the floor-standing base. The seat is made of soft integral polyurethane coloured en masse in black, red and blue. The support base is made of mass-coloured polyethylene in black, red and blue. Possibility of adding pivoting wheels to the support base to move the pouf easily. Indoor/outdoor use.

 Dia. 65/50 H. 45
Dia. 65/50 H. 45

Modello Model	Codice Code	Categoria materiale - Descrizione materiale Material category - Material description	Prezzo Retail con Iva Retail price with Vat
	D91080C650632	Poliuretano/Polietilene nero Black Polyurethane/Polyethylene	590,00
	D91087Z379044	Kit ruote 5pz Wheels kit 5 pcs	40,00
	D91088Z034091	Rivestimento in tessuto Cipro di colore nero Cipro fabric cover in black color	200,00
	D91080C650E17	Poliuretano/Polietilene rosso Red polyurethane/Polyethylene	590,00
	D91087Z379044	Kit ruote 5pz Wheels kit 5 pcs	40,00
	D91088Z034039	Rivestimento in tessuto Cipro di colore rosso Cipro fabric cover in red color	200,00
	D91080C650H02	Poliuretano/Polietilene blu Blue polyurethane/Polyethylene	590,00
	D91087Z379044	Kit ruote 5pz Wheels kit 5 pcs	40,00
	D91088Z034072	Rivestimento in tessuto Cipro di colore blu Cipro fabric cover in blue color	200,00

KOISHI
by Naoto Fukasawa
2007

Pouf



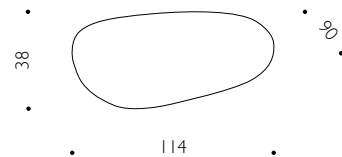

Struttura in fibra di vetro verniciata nei colori bianco, grigio antracite , rosa, giallo e rosso. Uso interno/esterno.

Ottoman

Painted fiberglass structure available in five different colors: white, anthracite grey, pink, yellow and red. Indoor/outdoor use.

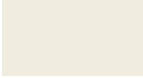

L 114 P. 90 H. 38 ; P.L. 33 Kg; V. 0,486 mc
W. 114 D. 90 H. 38 ; G.W. 33 kg; V. 0,486 cbm

Colore Color	Codice campione Sample code	Campionario nr. Sample box n.	Colore Color	Codice campione Sample code	Campionario nr. Sample box n.
 Fibra di vetro verniciata Bianco Ral 9010 lucido <i>Painted Glass fibre White Ral 9010 glossy</i>	VER002L5	6	 Fibra di vetro verniciata Gialla Ral 1032 lucido <i>Painted Glass fibre Yellow Ral 1032 glossy</i>	ND/NA	
 Fibra di vetro verniciata Grigio antr.Ral 7021 lucido <i>Painted Glass fibre Anth. gray Ral 7021 glossy</i>	VER057L2	7	 Fibra di vetro verniciata Rosso Ral 3020 lucido <i>Painted Glass fibre Red Ral 3020 glossy</i>	ND/NA	
 Fibra di vetro verniciata Rosa Ral 030 7020 lucido <i>Painted Glass fibre Pink Ral 030 7020 glossy</i>	ND/NA				

	Codice Code D04245H369002	Colore Color Bianco Ral 9010 lucido <i>White Ral 9010 glossy</i>	Prezzo Retail con Iva Retail price with Vat 1.300,00		Codice Code D04245H369057	Colore Color Grigio antracite Ral 7021 lucido <i>Anthracite gray Ral 7021 glossy</i>	Prezzo Retail con Iva Retail price with Vat 1.300,00
	D04245H369024	Rosa Ral 030 7020 lucido <i>Pink Ral 030 7020 glossy</i>	1.300,00		D04245H369021	Gialla Ral 1032 lucido <i>Yellow Ral 1032 glossy</i>	1.300,00
	D04245H369039	Rosso Ral 3020 lucido <i>Red Ral 3020 glossy</i>	1.300,00				

**SGABELLI/
*STOOLS***

TOKYO-POP
by Tokujin Yoshioka
2002

Sgabello
Monoblocco in polietilene realizzati mediante stampaggio rotazionale. Uso interno/
esterno.

Stool
Polyethylene monobloc made by rotational molding. Indoor/outdoor use.

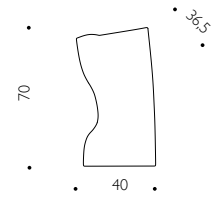

L. 40 P. 38 H. 70; P.L. 5 Kg; V. 0,075 mc
W. 40 D. 38 H. 70; G.W. 5 Kg; V. 0,075 cbm



Codice
Code

D28337B278002

Prezzo Retail con Iva
Retail price with Vat

370,00

Codice campione
Sample code

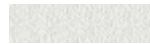

Polietilene Bianco Ral 9016
White Ral 9016 Polyethylene

PLA00202

5

D28337B278057



Polietilene Nero antracite Ral 7016
Anthracite Black Ral 7016 Polyethylene

PLA09105

370,00

5

**POLTRONE/
*ARMCHAIRS***

ELISA OUTDOOR

 by Enzo Mari
2015
Poltrona

Struttura realizzata in acciaio con trattamento protettivo di cataforesi verniciato a polveri poliestere black-brown, cuscini in schiuma poliuretanica, fibra soffiata di poliestere Solutex® e chips in memory con rivestimento impermeabile. Rivestimento esterno in tessuto idrorepellente. Copertura di protezione in poliestere bianco.

Armchair

Structure made of steel with protective cataphoresis treatment, finished in black-brown polyester paint, cushions in polyurethane foam of varying density and polyester Solutex® blown fiber and chips in memory with waterproof covering. Protection cover in white polyester.

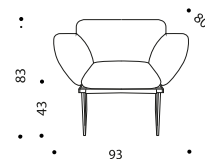

L. 93 P. 80 H. 83; seduta H. 43; P.L. 30 Kg; V. 0,77 mc
W. 93 D. 80 H. 83; seat H. 43; G.W. 30 Kg; V. 0,77 cbm

Modello Model	Codice Code	Categoria materiale - Descrizione materiale Material category - Material description	Prezzo Retail con Iva Retail price with Vat
	D10509A381	Acrylic Cipro/Acciaio verniciato cataforesi Acrylic Cipro/Cataphoresis painted steel	3.100,00
	D10509A837	Polipropilene Pantelleria/Acciaio verniciato cataforesi Polypropylene Pantelleria/Cataphoresis painted steel	
	D10802M383002	Tessuto poliestere di colore bianco Polyester fabric white color	210,00

PER LA SCELTA DELLA SCOCCA, TESSUTI E PELLI
CONSULTARE IL LIBRO "ABBINAMENTO TESSUTI-PELLI/
MATERIALI"

FOR THE CHOICE OF SHELL, FABRICS AND LEATHERS,
SEE BOOK "MATCHING FABRICS-LEATHERS/
MATERIALS"



Codice campione
Sample code

Campionario nr.
Sample box n.

ND/NA

MODESTY VEILED

 by Italo Rota
2013
Poltrona

Monoblocco in polietilene di colore bianco. Uso interno/esterno.

Armchair

White polyethylene monobloc. Indoor/outdoor use.

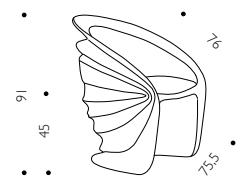

L. 75,5 P. 76 H. 45; seduta H. 45; P.L. 19,3 Kg; V. 0,520 mc
W. 75,5 D. 76 H. 45; seat H. 45; G.W. 19,3 Kg; V. 0,520 cbm



Codice
Code

D80008A278002

Prezzo Retail con Iva
Retail price with Vat

740,00

Codice campione
Sample code

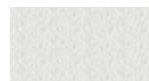

Polietilene Bianco Ral 9003
White Ral 9003 Polyethylene

PLA00205

5

MT1, MT3
by Ron Arad
2005

Poltrona, poltrona a dondolo

Monoblocco in polietilene di colore bianco sabbia (RAL 1013) all'esterno e rosso o nero all'interno. Uso interno/esterno.

Armchair, rocking chair

Polyethylene monobloc sand white (RAL 1013) colored outside and red or black colored inside. Indoor/outdoor use.

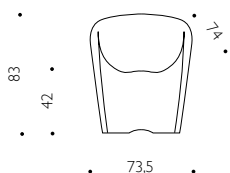

MT1 - Poltrona
L. 73,5 P. 74 H. 83; seduta H. 42; P.L. 18,8 Kg; V. 0,49 mc
MT1 - Armchair
W. 73,5 D. 74 H. 83; seat H. 42; G.W. 18,8 Kg; V. 0,49 cbm

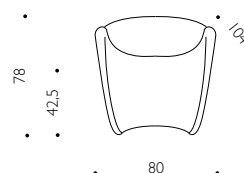

MT3 - Poltrona a dondolo
L. 80 P. 104 H. 78; seduta H. 42,5; P.L. 26,35 Kg; V. 0,648 mc
MT3 - Rocking armchair
W. 80 D. 104 H. 78; seat H. 42,5; G.W. 26,35 Kg; V. 0,648 cbm

Esterno
Outside

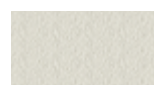

Polietilene Bianco sabbia
White sand Polyethylene

Codice campione
Sample code

PLAD4801

Campionario nr.
Sample box n.

5

Interno
Inside



I colori Rosso e Nero, che si trovano all'interno del prodotto MT, si ottengono solamente nel processo di lavorazione e quindi non sono campionabili.
The Red and Black colors, which are found inside the MT product, are obtained only in the manufacturing process and therefore cannot be sampled.

MT1



Codice
Code

D43738A278131

Prezzo Retail con Iva
Retail price with Vat

830,00

Codice campione
Sample code

PLAD4801



Polietilene Bianco sabbia
White sand Polyethylene
Polietilene Rosso Pantone 186C
Red Polyethylene Pantone 186C

D43738A278132



Polietilene Bianco sabbia
White sand Polyethylene
Polietilene Nero RAL 9005
Black Polyethylene RAL 9005

830,00

PLAD4801

MT3



Codice
Code

D44271N278131

Prezzo Retail con Iva
Retail price with Vat

1.090,00

Codice campione
Sample code

PLAD4801



Polietilene Bianco sabbia
White sand Polyethylene
Polietilene Rosso Pantone 186C
Red Polyethylene Pantone 186C

D44271N278132



Polietilene Bianco sabbia
White sand Polyethylene
Polietilene Nero RAL 9005
Black Polyethylene RAL 9005

1.090,00

PLAD4801

PLIE'

by Ludovica+Roberto
Palomba
2010

Poltrona

Monoblocco in polietilene disponibile in due varianti di colore: bianco o grigio chiaro.

Armchair

White or light grey polyethylene monobloc.

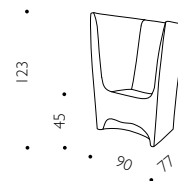

L. 90 P. 77 H. 123; seduta H. 45; P.L. 28 Kg; V. 1,07 mc
W. 93 D. 77 H. 123; seat H. 45; G.W. 28 Kg; V. 1,07 cbm

**Codice
Code**

D47358A278002

**Prezzo Retail con Iva
Retail price with Vat**

1.100,00

**Codice campione
Sample code**

Polietilene Bianco Ral 9016
White Ral 9016 Polyethylene

PLA002O2

D47358A278045

1.100,00



Polietilene Grigio chiaro Ral 7047
Light Grey Ral 7047 Polyethylene

PLA045O2

NEMO
by Fabio Novembre
2011

Poltrona

Poltrona monoblocco realizzata mediante stampaggio rotazionale in polietilene fissa disponibile nei colori: bianco, nero, grigio, rosso. Sarà possibile realizzare la poltrona Nemo laccata in RAL cliente, con tempistica di approntamento di 4 settimane data ordine e sovrapprezzo del 30%.

Armchair

Polyethylene armchair made by rotational molding fixed available in the colors: white, black, grey, red. It will be possible to realize the lacquered Nemo with a customized color (only if RAL referenced). The lead time will be of 4 weeks after the order confirmation and a surcharge of 30% will be applied on the current retail price.

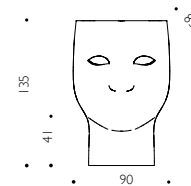

L. 90 P. 83 H. 135; seduta H. 41; P.L. 35 Kg; V. 1,08 mc
W. 90 D. 83 H. 135; seat H. 41; G.W. 35 Kg; V. 1,08 cbm



Codice versione fissa <i>Code fixed version</i>	Colore <i>Color</i>	Prezzo Retail con Iva <i>Retail price with Vat</i>
D42802B278002	Bianco Ral 9016 <i>White Ral 9016</i>	1.490,00

Codice versione fissa <i>Code fixed version</i>	Colore <i>Color</i>	Prezzo Retail con Iva <i>Retail price with Vat</i>
D42802B278091	Nero Ral 9011 <i>Black Ral 9011</i>	1.490,00

	Codice campione <i>Sample code</i>	Campionario nr. <i>Sample box n.</i>
Polietilene <i>Polyethylene</i>	PLA002O2	5

	Codice campione <i>Sample code</i>	Campionario nr. <i>Sample box n.</i>
Polietilene <i>Polyethylene</i>	PLA091O2	5



Codice versione fissa <i>Code fixed version</i>	Colore <i>Color</i>	Prezzo Retail con Iva <i>Retail price with Vat</i>
D42802B278039	Rosso Pantone 1797C <i>Red Pantone 1797C</i>	1.490,00

Codice <i>Code</i>	Colore <i>Color</i>	Prezzo Retail con Iva <i>Retail price with Vat</i>
D42802B278044	Grigio Pantone 7537U <i>Grey Pantone 7537U</i>	1.490,00

	Codice campione <i>Sample code</i>	Campionario nr. <i>Sample box n.</i>
Polietilene <i>Polyethylene</i>	PLA039O1	5

	Codice campione <i>Sample code</i>	Campionario nr. <i>Sample box n.</i>
Polietilene <i>Polyethylene</i>	PLA044O1	5

NEMO

by Fabio Novembre
2011

Poltrona

Poltrona monoblocco realizzata mediante stampaggio rotazionale in polietilene fissa verniciata nei colori rosso oppure Denim. Sarà possibile realizzare la poltrona Nemo laccata in RAL cliente, con tempistica di approntamento di 4 settimane data ordine e sovrapprezzo del 30%.

Armchair

Polyethylene armchair made by rotational molding fixed in red or black lacquered or Denim polyethylene. It will be possible to realize the lacquered Nemo with a customized color (only if RAL referenced). The lead time will be of 4 weeks after the order confirmation and a surcharge of 30% will be applied on the current retail price.

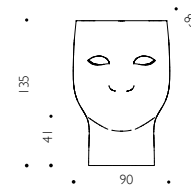

L. 90 P. 83 H. 135; seduta H. 41; P.L. 35 Kg; V. 1,08 mc
W. 90 D. 83 H. 135; seat H. 41; G.W. 35 Kg; V. 1,08 cbm



Codice versione fissa
Code fixed version

Colore
Color

Prezzo Retail con Iva
Retail price with Vat

D42802B279039

Rosso Pantone 485C
Red Pantone 485C

2.990,00



Polietilene laccato
Lacquered polyethylene

Codice campione
Sample code
VER039L3

Campionario nr.
Sample box n.
6

Codice versione fissa
Code fixed version

Colore
Color

Prezzo Retail con Iva
Retail price with Vat

D42802B279091

Nero Ral 9017
Black Ral 9017

2.990,00



Polietilene laccato
Lacquered polyethylene

Codice campione
Sample code
VER091L6

Campionario nr.
Sample box n.
7



Codice versione fissa
Code fixed version

Colore
Color

Prezzo Retail con Iva
Retail price with Vat

D42802B278130

Denim
Denim

1.790,00



Polietilene
Polyethylene

Codice campione
Sample code
ND/NA

Campionario nr.
Sample box n.

NEMO BLACK IS THE NEW GREEN

by Fabio Novembre
2021

Poltrona

Il materiale con il quale è realizzata la poltrona Nemo, deriva da riciclo industriale proveniente da scarti di produzione interna, e pertanto controllati, e da riciclo post consumo vale a dire da prodotti smaltiti con raccolta differenziata - come l'esempio di bottiglie e contenitori in PET - e riciclati dando così vita a nuovi oggetti.

Armchair

The armchair Nemo is made of material which comes from industrial recycling, partly from internal production waste, and therefore controlled, and partly from post-consumer recycling, i.e. from products disposed of with separate collection - such as PET bottles - and recycled thus giving life to new objects.

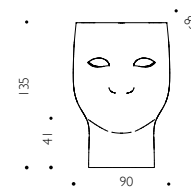

L. 90 P. 83 H. 135; seduta H. 41; P.L. 35 Kg; V. 1,08 mc
W. 90 D. 83 H. 135; seat H. 41; G.W. 35 Kg; V. 1,08 cbm



driade



Codice versione fissa
Code fixed version

D42802B476091

Prezzo Retail con Iva
Retail price with Vat

1.490,00



Polietilene riciclato nero
Eco Black Polyethylene

Codice campione
Sample code

ND/NA

Campionario nr.
Sample box n.

NEMO CUSTOM

by Fabio Novembre
2021

Poltrona

Le Nemo Custom sono eco-friendly perchè realizzate con l'utilizzo di vernici di nuova generazione. Driade continua la sua ricerca verso una produzione che preveda un sempre minore impatto ambientale grazie all'impiego di vernici acriliche opache all'acqua che conferiscono al prodotto una particolare resistenza all'usura, alla luce e agli agenti atmosferici oltre ad ottenere un aspetto estetico, e al tatto, morbido e "setoso". Infinite le combinazioni possibili per personalizzare la propria Nemo scegliendo il colore preferito per l'esterno della poltrona e decidendo se mantenere l'interno dello stesso colore oppure sceglierlo in una versione neutra: nero o bianco.

Armchair

Nemo Custom are eco-friendly because they are made using new generation paints. Driade continues its research towards a production that foresees the lowest environmental impact thanks to the use of water-based matt acrylic paints that give the product a particular resistance to the use, to the light and to atmospheric agents as well as an aesthetic appearance, a soft and "silky" touch. There are countless possible combinations to personalise your Nemo by choosing your favourite colour for the outside of the armchair and deciding whether to keep the inside of the same colour or choose a neutral version: black or white.

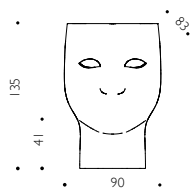

L. 90 P. 83 H. 135; seduta H. 41; P.L. 35 Kg; V. 1,08 mc
W. 90 D. 83 H. 135; seat H. 41; G.W. 35 Kg; V. 1,08 cbm



NEMO CUSTOM by Fabio Novembre, 2021

Codice Code	Materiale Material	Colore Color	Consegna Delivery	Prezzo Retail con Iva Retail price with Vat
D42802B477 Versione fiss <i>Fixed version</i>	Polietilene verniciato opaco soft touch <i>Soft touch matt varnished polyethylene</i>	rif. RAL <i>ref. RAL</i>	6 settimane dalla conferma d'ordine <i>6 weeks from order confirmation</i>	3.050,00





Ral 1000



Ral 9003



Ral 9010



Ral 1017



Ral 3015



Ral 6013



Ral 9002



Ral 1015



Ral 2003



Ral 3014



Ral 6011



Ral 6019



Ral 1014



Ral 2008



Ral 3018



Ral 6010



Ral 6021



Ral 1016



Ral 2011



Ral 3028



Ral 6003



Ral 6018



Ral 1018



Ral 2009



Ral 3020



Ral 6006



Ral 6017



Ral 1003



Ral 2004



Ral 3001



Ral 6007



Ral 6037



Ral 1033



Ral 2001



Ral 3003



Ral 6008



Ral 6029



Ral 1028



Ral 2002



Ral 3004



Ral 6009



Ral 6028



Ral 1037



Ral 2013



Ral 3005



Ral 6022



Ral 6005



Ral 2000



Ral 2009



Ral 3007



Ral 4009



Ral 5024



Ral 7047



Ral 9018



Ral 9016



Ral 4003



Ral 5023



Ral 7040



Ral 7035



Ral 7038



Ral 4010



Ral 5007



Ral 5014



Ral 6034



Ral 7045



Ral 4006



Ral 5000



Ral 5012



Ral 6027



Ral 7001



Ral 4008



Ral 5013



Ral 5015



Ral 6033



Ral 7000



Ral 4001



Ral 5003



Ral 5019



Ral 5013



Ral 7031



Ral 4005



Ral 5022



Ral 5017



Ral 5021



Ral 7011



Ral 4011



Ral 5008



Ral 5005



Ral 5025



Ral 7024



Ral 4012



Ral 5011



Ral 5010



Ral 5001



Ral 7016



Ral 4007



Ral 5004



Ral 5026



Ral 5020



Ral 9011

ROLY POLY
by Faye Toogood
2018

Poltrona

Poltrona monoblocco in polietilene realizzata mediante stampaggio rotazionale per un utilizzo sia outdoor che indoor. Disponibile una cuscinatura di seduta/schienale realizzata con un interno in fib a di poliestere ed un rivestimento in tessuto non sfoderabile. Uso interno/esterno.

Armchair

Polyethylene monobloc armchair made by rotational molding for both outdoor and indoor use. It is available with seat / back cushions made of inside part in polyester fiber interior and a non-removable fabric cover. Indoor/outdoor use.

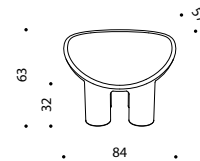

L. 84 P. 57 H. 63; seduta H. 32; P.L. 14,2 Kg; V. 0,362 mc
W. 87 D. 57 H. 63; seat H. 32; G.W. 14,2 Kg; V. 0,362 cbm



Codice Code	Colore Color	Prezzo Retail con Iva Retail price with Vat	Codice campione Sample code	Campionario nr. Sample box n.
D28478A278019	Giallo ocra Ochre yellow	580,00	PLA01901	5
	Polietilene Giallo Ral 1032 Yellow Ral 1032 Polyethylene			

Codice Code	Colore Color	Prezzo Retail con Iva Retail price with Vat	Codice campione Sample code	Campionario nr. Sample box n.
D28478A278037	Rosso mattone Red brick	580,00	PLA03701	5
	Polietilene Rosso Ral 3016 Red Ral 3016 Polyethylene			



Codice Code	Colore Color	Prezzo Retail con Iva Retail price with Vat	Codice campione Sample code	Campionario nr. Sample box n.
D28478A278088	Carbone Charcoal	580,00	PLA08801	5
	Polietilene Nero Ral 9011 Black Ral 9011 Polyethylene			

Codice Code	Colore Color	Prezzo Retail con Iva Retail price with Vat	Codice campione Sample code	Campionario nr. Sample box n.
D28478A476091	Nero Black	580,00	ND/NA	
 	Polietilene riciclato nero Eco Black Polyethylene			

ROLY POLY
by Faye Toogood
2018

Poltrona

Poltrona monoblocco in polietilene realizzata mediante stampaggio rotazionale per un utilizzo sia outdoor che indoor. Disponibile una cuscinatura di seduta/schienale realizzata con un interno in fib a di poliestere ed un rivestimento in tessuto non sfoderabile. Uso interno/esterno.

Armchair

Polyethylene monobloc armchair made by rotational molding for both outdoor and indoor use. It is available with seat / back cushions made of inside part in polyester fiber interior and a non-removable fabric cover. Indoor/outdoor use.

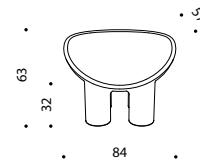

L. 84 P. 57 H. 63; seduta H. 32; P.L. 14,2 Kg; V. 0,362 mc
W. 87 D. 57 H. 63; seat H. 32; G.W. 14,2 Kg; V. 0,362 cbm





Codice Code	Colore Color	Prezzo Retail con Iva Retail price with Vat	Codice campione Sample code	Campionario nr. Sample box n.
D28478A278087	Torba Peat	580,00		
	Polietilene Marrone Ral 8011 Brown Ral 8011 Polyethylene		PLA087O1	5

Codice Code	Colore Color	Prezzo Retail con Iva Retail price with Vat	Codice campione Sample code	Campionario nr. Sample box n.
D28478A278089	Cemento Concrete	580,00		
	Polietilene Grigio chiaro Ral Design 000 85 00 Light Grey Ral Design 000 85 00 Polyethylene		PLA089O1	5



Codice Code	Colore Color	Prezzo Retail con Iva Retail price with Vat	Codice campione Sample code	Campionario nr. Sample box n.
D28478A278026	Rosa carne Flesh	580,00		
	Polietilene Rosa Ral Design 030 70 20 Pink Ral Design 030 70 20 Polyethylene		PLA026O1	5

ROLY POLY by Faye Toogood, 2018

Modello Model	Codice Code	Categoria materiale - Descrizione materiale Material category - Material description	Prezzo Retail con Iva Retail price with Vat
		<p>  Disponibile la versione ignifuga BS 5852 Domestic con maggiorazione del 35% solo per tessuti contrassegnati con *. Uso solo interno. Tessuto Cliente consentito, si prega di fare riferimento al nostro servizio clienti. <i>Available the flame retardant version BS 5852 Domestic with 35% surcharge only for fabrics marked with *. Indoor use only, COM and COL allowed, please refer to our Customer Service.</i> </p>	
Cuscinatura seduta/schienale tessuto indoor <i>Seat/back cushions indoor fabric</i>	D30264D700 D30264D701 D30264D704 D30264D705 D30264D036 D30264D040 D30264D709 D30264D712	Cat.A Cotone Bonifacio * <i>Cat. A Cotton Bonifacio *</i> Cat. A Poliestere Marsiglia <i>Cat. A Polyester Marsiglia</i> Cat. B misto Poliestere, Acrilico, Cotone Berlino * <i>Cat. B mixed Polyester, Acrylic, Cotton Berlino *</i> Cat. B Poliestere Jakarta <i>Cat. B Polyester Jakarta</i> Cat. C Misto Lino Lisbona <i>Cat. C Linen Mix Lisbona</i> Cat. C Lino Barcellona * <i>Cat. C Linen Barcellona *</i> Cat. C Polipropilene Amburgo * <i>Cat. C Polypropylene Amburgo *</i> Cat. D Lana vergine, Cotone, Poliammide Malmö <i>Cat. D virgin Wool, Cotton, Polyamide Malmö</i>	330,00 390,00 480,00 515,00
Cuscinatura seduta/schienale tessuto outdoor <i>Seat/back cushions outdoor fabric</i>	D30266D034 D30266D716	Cat. B Acrilico Cipro outdoor <i>Cat. B Acrylic Cipro outdoor</i> Cat. B Polipropilene outdoor Pantelleria <i>Cat. B Polypropylene outdoor Pantelleria</i>	320,00

TOKYO-POP
 by Tokujin Yoshioka
 2002
Poltrona, sgabello

Monoblocco in polietilene realizzati mediante stampaggio rotazionale. Uso interno/esterno.

Armchair, stool

Polyethylene monobloc made by rotational molding. Indoor/outdoor use.

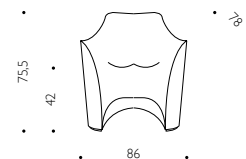

L. 86 P. 78 H. 75,5; seduta H. 42; bracc. H. 63; P.L. 26 Kg; V. 0,591 mc
 W. 86 D. 78 H. 75,5; seat H. 42; armrest H. 63; G.W. 26 Kg; V. 0,591 cbm



Codice
Code

D28348A278002

Prezzo Retail con Iva
Retail price with Vat

760,00

Codice campione
Sample code



Polietilene Bianco Ral 9016
White Ral 9016 Polyethylene

PLA002O2

5

D28348A278057



Polietilene Nero antracite Ral 7016
Anthracite Black Ral 7016 Polyethylene

PLA091O5

760,00

5

**DIVANI/
SOFAS**

ELISA OUTDOOR

by Enzo Mari
2015

Divani

Struttura realizzata in acciaio con trattamento protettivo di cataforesi verniciato a polveri poliestere black-brown, cuscini in schiuma poliuretana, fibra soffiata di poliestere Solutex® e chips in memory con rivestimento impermeabile. Rivestimento esterno in tessuto idrorepellente Copertura di protezione in poliestere bianco.
Versione per esterni.

Sofas

Structure made of steel with protective cataphoresis treatment, finished in black-brown polyester paint, cushions in polyurethane foam of varying density and polyester Solutex® blown fiber and chips in memory with waterproof covering. Protection cover in white polyester.
Outdoor version.

Modello Model	Codice Code	Categoria materiale - Descrizione materiale Material category - Material description	Prezzo Retail con Iva Retail price with Vat
Divano 2 posti L. 160 P. 80 H. 83; seduta H. 43; P.L. 48,5 Kg; V. 1,284 mc Two-seater sofa W. 160 D. 80 H. 83; seat H. 43; G.W. 48,5 Kg; V. 1,284 cbm	D10605C381	Acrilico Cipro/Acciaio verniciato cataforesi <i>Acrylic Cipro/Cataphoresis painted steel</i>	4.400,00
	D10605C837	Polipropilene Pantelleria/Acciaio verniciato cataforesi <i>Polypropylene Pantelleria/Cataphoresis painted steel</i>	
	D10812M383002	Tessuto poliestere di colore bianco <i>Polyester fabric white color</i>	280,00
Divano 3 posti L. 235 P. 80 H. 83; Seduta H. 43; P.L. 50 Kg; V. 1,90 mc Three-seater sofa W. 235 D. 80 H. 83; Seat H. 43; G.W. 50 Kg; V. 1,90 cbm	D10606C381	Acrilico Cipro/Acciaio verniciato cataforesi <i>Acrylic Cipro/Cataphoresis painted steel</i>	5.500,00
	D10606C837	Polipropilene Pantelleria/Acciaio verniciato cataforesi <i>Polypropylene Pantelleria/Cataphoresis painted steel</i>	
	D10822M383002	Tessuto poliestere di colore bianco <i>Polyester fabric white color</i>	320,00



GRAND PLIÈ

by Ludovica+Roberto
Palomba
2010

Divano

Monoblocco in polietilene disponibile in due varianti di colore: bianco o grigio chiaro.

Sofa

White or light grey polyethylene monobloc.

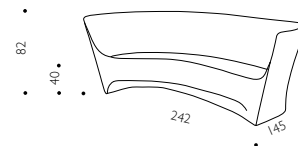

L. 242 P. 145 H. 82; seduta H. 40; P.L. 56 Kg; V. 3,6 mc
W. 242 D. 145 H. 82; seat H. 40; G.W. 56 Kg; V. 3,6 cbm



Codice
Code

D47559C278002

Prezzo Retail con Iva
Retail price with Vat

2.190,00

Codice campione
Sample code

PLA002O2

Campionario nr.
Sample box n.

5



Polietilene Bianco Ral 9016
White Ral 9016 Polyethylene

D47559C278045

2.190,00



Polietilene Grigio chiaro Ral 7047
Light Grey Ral 7047 Polyethylene

PLA045O2

MT2
by Ron Arad
2005

Divano

Monoblocco in polietilene di colore bianco sabbia (RAL 1013) all'esterno e rosso o nero all'interno. Uso interno/esterno.

Sofa

Polyethylene monobloc sand white (RAL 1013) colored outside and red or black colored inside. Indoor/outdoor use.

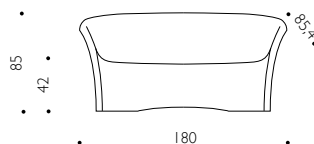

Esterno
Outside

Interno
Inside

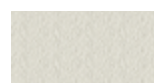

Polietilene Bianco sabbia
White sand Polyethylene

Codice campione
Sample code

PLAD4801

Campionario nr.
Sample box n.

5



I colori Rosso e Nero, che si trovano all'interno del prodotto MT, si ottengono solamente nel processo di lavorazione e quindi non sono campionabili.
The Red and Black colors, which are found inside the MT product, are obtained only in the manufacturing process and therefore cannot be sampled.



Codice
Code

Prezzo Retail con Iva
Retail price with Vat

D44145C278131

1.380,00

Codice campione
Sample code

PLAD4801

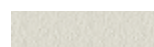

Polietilene Bianco sabbia
White sand Polyethylene



Polietilene Rosso Pantone 186C
Red Polyethylene Pantone 186C

D44145C278132

1.380,00

PLAD4801



Polietilene Bianco sabbia
White sand Polyethylene



Polietilene Nero RAL 9005
Black Polyethylene RAL 9005

ROLY POLY
by Faye Toogood
2018

Divano

Poltrona monoblocco in polietilene realizzata mediante stampaggio rotazionale per un utilizzo sia outdoor che indoor. Disponibile una cuscinatura di seduta/schienale realizzata con un interno in fib a di poliestere ed un rivestimento in tessuto non sfoderabile. Uso interno/esterno.

Sofa

Polyethylene monobloc armchair made by rotational molding for both outdoor and indoor use. It is available with seat / back cushions made of inside part in polyester fiber interior and a non-removable fabric cover. Indoor/outdoor use.

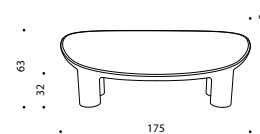

L. 84 P. 57 H. 63; seduta H. 32; P.L. 25,2 Kg; V. 0,799 mc
W. 84 D. 57 H. 63; seat H. 32; G.W. 25,2 Kg; V. 0,799 cbm



Codice Code	Colore Color	Prezzo Retail con Iva Retail price with Vat
D30125C278019	Giallo ocra Ochre yellow	845,00
	Codice campione Sample code	Campionario nr. Sample box n.



Polietilene Giallo Ral 1032
Yellow Ral 1032 Polyethylene

PLA01901

5



Codice Code	Colore Color	Prezzo Retail con Iva Retail price with Vat
D30125C278037	Rosso mattone Red brick	845,00
	Codice campione Sample code	Campionario nr. Sample box n.



Polietilene Rosso Ral 3016
Red Ral 3016 Polyethylene

PLA03701

5



Codice Code	Colore Color	Prezzo Retail con Iva Retail price with Vat
D30125C278088	Carbone Charcoal	845,00
	Codice campione Sample code	Campionario nr. Sample box n.



Polietilene Nero Ral 9011
Black Ral 9011 Polyethylene

PLA08801

5



Codice Code	Colore Color	Prezzo Retail con Iva Retail price with Vat
D30125C278087	Torba Peat	845,00
	Codice campione Sample code	Campionario nr. Sample box n.



Polietilene Marrone Ral 8011
Brown Ral 8011 Polyethylene

PLA08701

5

ROLY POLY
by Faye Toogood
2018

Divano

Poltrona monoblocco in polietilene realizzata mediante stampaggio rotazionale per un utilizzo sia outdoor che indoor. Disponibile una cuscinatura di seduta/schienale realizzata con un interno in fib a di poliestere ed un rivestimento in tessuto non sfoderabile. Uso interno/esterno.

Sofa

Polyethylene monobloc armchair made by rotational molding for both outdoor and indoor use. It is available with seat / back cushions made of inside part in polyester fiber interior and a non-removable fabric cover. Indoor/outdoor use.

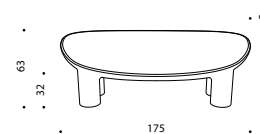



L. 84 P. 57 H. 63; seduta H. 32 ; P.L. 25,2 Kg; V. 0,799 mc
W. 84 D. 57 H. 63; seat H. 32; G.W. 25,2 Kg; V. 0,799 cbm



Codice Code	Colore Color	Prezzo Retail con Iva Retail price with Vat	Codice campione Sample code	Campionario nr. Sample box n.
D30125C278089	Cemento Concrete	845,00	PLA08901	5
	Polietilene Grigio chiaro Ral Design 000 85 00 Light Grey Ral Design 000 85 00 Polyethylene			

Codice Code	Colore Color	Prezzo Retail con Iva Retail price with Vat	Codice campione Sample code	Campionario nr. Sample box n.
D30125C278026	Rosa carne Flesh	845,00	PLA02601	5
	Polietilene Rosa Ral Design 030 70 20 Pink Ral Design 030 70 20 Polyethylene			

ROLY POLY by Faye Toogood, 2018

Modello Model	Codice Code	Categoria materiale - Descrizione materiale Material category - Material description	Prezzo Retail con Iva Retail price with Vat
 <p data-bbox="63 869 473 897">Cuscineria seduta/schienale tessuto indoor</p> <p data-bbox="63 919 365 947">Seat/back cushions indoor fabric</p>	<p data-bbox="826 869 948 897">D30293D700</p> <p data-bbox="826 941 948 969">D30293D701</p> <p data-bbox="826 1013 948 1041">D30293D704</p> <p data-bbox="826 1085 948 1113">D30293D705</p> <p data-bbox="826 1157 948 1185">D30293D036</p> <p data-bbox="826 1229 948 1257">D30293D040</p> <p data-bbox="826 1301 948 1330">D30293D709</p> <p data-bbox="826 1373 948 1402">D30293D712</p>	<p data-bbox="979 345 1548 526">  Disponibile la versione ignifuga BS 5852 Domestic con maggiorazione del 35% solo per tessuti contrassegnati con *. Uso solo interno. Tessuto Cliente consentito, si prega di fare riferimento al nostro servizio clienti. Available the flame retardant version BS 5852 Domestic with 35% surcharge only for fabrics marked with *. Indoor use only, COM and COL allowed, please refer to our Customer Service. </p> <p data-bbox="979 869 1166 919">Cat.A Cotone Bonifacio * Cat. A Cotton Bonifacio *</p> <p data-bbox="979 941 1179 991">Cat. A Poliestere Marsiglia Cat. A Polyester Marsiglia</p> <p data-bbox="979 1013 1343 1063">Cat. B misto Poliestere, Acrilico, Cotone Berlino * Cat. B mixed Polyester, Acrylic, Cotton Berlino *</p> <p data-bbox="979 1085 1166 1135">Cat. B Poliestere Jakarta Cat. B Polyester Jakarta</p> <p data-bbox="979 1157 1172 1207">Cat. C Misto Lino Lisbona Cat. C Linen Mix Lisbona</p> <p data-bbox="979 1229 1166 1279">Cat. C Lino Barcellona * Cat. C Linen Barcellona *</p> <p data-bbox="979 1301 1221 1351">Cat. C Polipropilene Amburgo * Cat. C Polypropylene Amburgo *</p> <p data-bbox="979 1373 1343 1423">Cat. D Lana vergine, Cotone, Poliammide Malmö Cat. D virgin Wool, Cotton, Polyamide Malmö</p>	<p data-bbox="1627 869 1685 897">670,00</p> <p data-bbox="1627 1013 1685 1041">760,00</p> <p data-bbox="1627 1157 1685 1185">820,00</p> <p data-bbox="1627 1373 1685 1402">990,00</p>
<p data-bbox="63 1491 485 1520">Cuscineria seduta/schienale tessuto outdoor</p> <p data-bbox="63 1541 378 1570">Seat/back cushions outdoor fabric</p>	<p data-bbox="826 1491 948 1520">D30266D034</p> <p data-bbox="826 1563 948 1592">D30266D716</p>	<p data-bbox="979 1491 1193 1541">Cat. B Acrilico Cipro outdoor Cat. B Acrylic Cipro outdoor</p> <p data-bbox="979 1563 1284 1613">Cat. B Polipropilene outdoor Pantelleria Cat. B Polypropylene outdoor Pantelleria</p>	<p data-bbox="1627 1491 1685 1520">590,00</p>

TOKYO-POP
by Tokujin Yoshioka
2002

Divano, dormeuse

Monoblocco in polietilene realizzati mediante stampaggio rotazionale. Uso interno/esterno.

Sofa, daybed

Polyethylene monobloc made by rotational molding. Indoor/outdoor use.

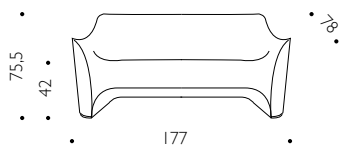

Divano 2 posti
L. 177 P. 78 H. 75,5; seduta H. 42; bracciolo H. 63;
P.L. 45 Kg; V. 1,320 mc
Two-seater sofa
W. 177 D. 78 H. 75,5; seat H. 42; armrest H. 63;
G.W. 45 Kg; V. 1,320 cbm

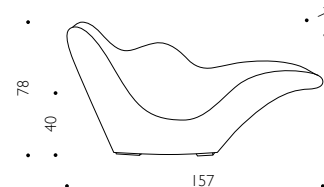

Dormeuse
L. 157 P. 74 H. 78; seduta H. 40; bracciolo H. 65;
P.L. 30 Kg; V. 1,021 mc
Daybed
W. 157 D. 74 H. 78; seat H. 40; armrest H. 65;
G.W. 30 Kg; V. 1,021 cbm



Codice Code	Prezzo Retail con Iva Retail price with Vat	Codice campione Sample code	Codice Code	Prezzo Retail con Iva Retail price with Vat
D28355C278002	1.100,00		D48369E278002	1.215,00
 Polietilene Bianco Ral 9016 White Ral 9016 Polyethylene		PLA002O2	 Polietilene Bianco Ral 9016 White Ral 9016 Polyethylene	
	5			5
D28355C278057	1.100,00		D48369E278057	1.215,00
 Polietilene Nero antracite Ral 7016 Anthracite Black Ral 7016 Polyethylene			 Polietilene Nero antracite Ral 7016 Anthracite Black Ral 7016 Polyethylene	
		PLA091O5		5

**TAVOLI/
*TABLES***

APP
by Ludovix + Roberto
Palomba
2016

Tavolo
Struttura in polipropilene disponibile nei colori bianco o nero. Uso interno/esterno.

Table
Polypropylene structure and top available in white or black color. Indoor/outdoor use.

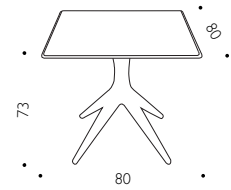

L. 80 P. 80 H. 73; P.L. 15 KG; V. 0,467 mc
W. 80 D. 80 H. 73; G.W. 15 KG; V. 0,467 cbm



Codice Code **Prezzo Retail con Iva Retail price with Vat**

D00622V379002

740,00

Codice campione Sample code **Campionario nr. Sample box n.**



Polipropilene Bianco Ral 9016
Polypropylene White Ral 9016

PLA002O2

5

Codice Code **Prezzo Retail con Iva Retail price with Vat**

D00622V379091

740,00

Codice campione Sample code **Campionario nr. Sample box n.**



Polipropilene Nero Antracite Ral 7016
Polyprop. Anthracite Black Ral 7016

PLA091O5

5

KALIMBA
by Driade Lab
2021
Tavolo

Tavolo interamente in alluminio estruso in due finiture: verniciato bianco a polvere poliestere o anodizzato alluminio argento. Il piano è costituito da doghe accostate tra loro, gambe in estruso di alluminio con piedino di regolazione per la messa a livello. Uso interno/esterno.

Table

Table made completely of extruded aluminium in two finishes: white polyester powder or silver aluminium anodized. The top is made of slats placed side by side, legs are made of extruded aluminium with adjustment foot for levelling. Indoor/outdoor use.

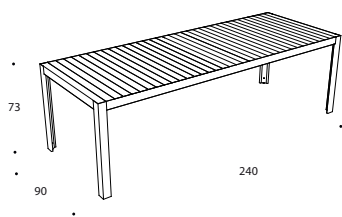

L. 180 P. 90 H. 73
W. 180 D. 90 H. 73
P.L. 25,5 Kg; V. 0,220 mc
G.W. 25,5 Kg; V. 0,220 cbm

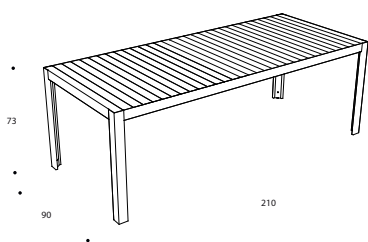

L. 210 P. 90 H. 73
W. 210 D. 90 H. 73
P.L. 28,5 Kg; V. 0,256 mc
G.W. 28,5 Kg; V. 0,256 cbm

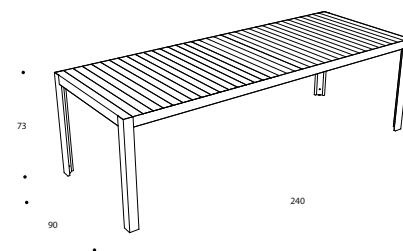

L. 240 P. 90 H. 73
W. 240 D. 90 H. 73
P.L. 30,5 Kg; V. 0,292 mc
G.W. 30,5 Kg; V. 0,292 cbm

Colore
Color

Codice campione
Sample code

Campionario nr.
Sample box n.

Alluminio vern. Bianco Ral 9010 lucido
Painted al. white Ral 9010 glossy

VER002L5

6

Alluminio anodizzato
Anodized Aluminum

MET114O2

7

L.180P.90H.73/ W.180D.90H.73



Codice Code **Prezzo Retail con Iva Retail price with Vat**

D00369H437002

2.190,00

Codice campione Sample code

Campionario nr. Sample box n.



Bianco Ral 9010 lucido
White Ral 9010 glossy

VER002L5

6

L.180P.90H.73/ W.180D.90H.73



Codice Code **Prezzo Retail con Iva Retail price with Vat**

D00369H434043

1.980,00

Codice campione Sample code

Campionario nr. Sample box n.

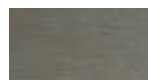

Alluminio anodizzato
Anodized Aluminum

MET114O2

7

L.210P.90H.73/ W.210D.90H.73



Codice Code **Prezzo Retail con Iva Retail price with Vat**

D00360I437002

2.370,00

Codice campione Sample code

Campionario nr. Sample box n.



Bianco Ral 9010 lucido
White Ral 9010 glossy

VER002L5

6

L.210P.90H.73/ W.210D.90H.73



Codice Code **Prezzo Retail con Iva Retail price with Vat**

D00360I434043

2.150,00

Codice campione Sample code

Campionario nr. Sample box n.

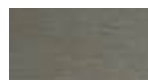

Alluminio anodizzato
Anodized Aluminum

MET114O2

7

L.240P.90H.73/ W.240D.90H.73



Codice Code **Prezzo Retail con Iva Retail price with Vat**

D00361I437002

2.590,00

Codice campione Sample code

Campionario nr. Sample box n.

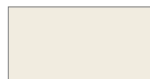

Bianco Ral 9010 lucido
White Ral 9010 glossy

VER002L5

6

L.240P.90H.73/ W.240D.90H.73



Codice Code **Prezzo Retail con Iva Retail price with Vat**

D00361I434043

2.370,00

Codice campione Sample code

Campionario nr. Sample box n.



Alluminio anodizzato
Anodized Aluminum

MET114O2

7

KISSI KISSI
by Miki Astori
2005
Tavolo

Struttura e piano in polietilene in due varianti di colore, bianco o grigio antracite. Uso interno/esterno.

Table

Polyethylene structure and top available in white or anthracite grey color. Indoor/ outdoor use.

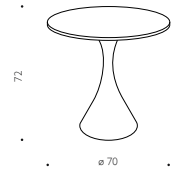

ø 70 H. 72; P.L. 15 Kg; V. 0,40 mcc
ø 70 H. 72; G.W. 15 Kg; V. 0,40 cbm



Codice
Code

Codice campione
Sample code

Prezzo Retail con Iva
Retail price with Vat

D43141V278002

650,00



Polietilene Bianco Ral 9016
White Ral 9016 Polyethylene

PLA002O2

5



Codice
Code

Codice campione
Sample code

Prezzo Retail con Iva
Retail price with Vat

D43141V278057

650,00



Polietilene Nero antracite Ral 7016
Anthracite black Ral 7016
Polyethylene

PLA091O5

5

LORD YI
by Philippe Starck
Palomba
2017

Tavolo

Base in fusione di alluminio verniciato di colore grigio alluminio o nero antracite e colonna in alluminio anodizzato di colore argento o nero. Piano in San di colore avorio, piano in marmo bianco Carrara o nero Marquina oppure in SAN con finitura superficiale tramite rasatura a mano con spatola di un composto a base di argilla colorato in massa. Le sfumature dell'applicazione manuale caratterizzano l'estetica del prodotto. Il trattamento finale rende il prodotto idrorepellente ed antimacchia. Sono disponibili i colori: champagne, avorio, lava e rosso. Uso interno/esterno. È disponibile a richiesta un contrappeso in cemento di Kg 9 (cod.D174300451154).

Table

Grey or black anthracite painted aluminum base and grey or black anthracite anodized aluminum column. Ivory San, white Carrara or black Marquina marble or SAN top with a surface finish hand made shaving a spatula of a colored clay-based compound. The nuances of the manual application characterize the aesthetics of the product. The final treatment makes the product water-repellent and stain-resistant. Available in the colors: champagne, ivory, anthracite grey and red. Indoor/outdoor use. A 9 Kg. cement counterbalance can be available on demand (code D174300451154).

Versione piano in SAN
SAN top version



L. 80 P. 80 H. 73
P.L. 24,35 Kg; V. 0,40 mc
W. 80 D. 80 H. 73
G.W. 24,35 Kg; V. 0,40 cbm

Versione piano in SAN
SAN top version



ø 60 H. 73;
P.L. 10,35 Kg; V. 0,040 mc
ø 60 H. 73
G.W. 10,35 Kg; V. 0,040 cbm

Versione piano in marmo
Marble top version



ø 60 H. 73
Base: P.L. 5,35 Kg; V. 0,017 mc
Piano: P.L. 23 Kg; V. 0,066 mc
ø 60 H. 73
Base: G.W. 5,35 Kg; V. 0,017 cbm
Top: G.W. 23 Kg; V. 0,066 cbm



Versione piano in marmo
Marble top version

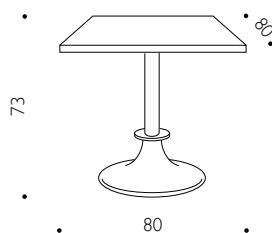

L. 60 P. 60 H. 73
Base: P.L. 5,35 Kg; V. 0,017 mc
Piano: P.L. 27 Kg; V. 0,066 mc
W. 60 D. 60 H. 73
Base: G.W. 5,35 Kg; V. 0,017 cbm
Top: G.W. 27 Kg; V. 0,066 cbm



L. 80 P. 80 H. 73
W. 80 D. 80 H. 73



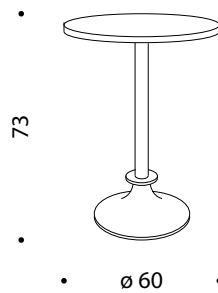



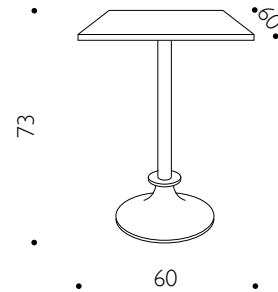

Codice Code	Colore Color	Prezzo di vendita Selling price	Codice campione Sample code	Campionario nr. Sample box n.
D17142V388B46		830,00		
Versione piano in SAN SAN top version				
	SANAvorio SANIvory		PLA004L1	5
	Alluminio verniciato Grigio alluminio Painted Aluminum Grey al. color		VER044O3	7

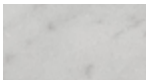

ø 60 H.73
ø 60 H.73



L. 60 P. 60 H. 73
W. 60 D. 60 H. 73

Codice Code	Colore Color	Prezzo Retail con Iva Retail price with Vat	Codice campione Sample code	Campionario nr. Sample box n.	Codice Code	Colore Color	Prezzo Retail con Iva Retail price with Vat	
D17131V388B46 Versione piano in SAN SAN top version		750,00			D17141V389B47 Versione piano in marmo Marble top version		1.370,00	
	SAN Avorio SAN Ivory		PLA004L1	5		Marmo Carrara bianco levigato Smooth white Carrara marble	MAR002O1	8
	Alluminio verniciato Grigio alluminio Painted Aluminum Grey al. color		VER044O3	7		Alluminio verniciato Grigio alluminio Painted Aluminum Grey al. color	VER044O3	7
D17131V390B48 Versione piano in marmo Marble top version		1.515,00			D17430O451154	Contrappeso Counterbalance	135,00	
	Marmo Marquina Nero lucido Black polished Marquina marble		MAR091L1	8			Prezzo di vendita Selling price	
	Alluminio verniciato Grigio antracite Painted Aluminum Anthracite Grey		VER057O1	7				
D17430O451154	Contrappeso Counterbalance	135,00			D17141V390B48 Versione piano in marmo Marble top version		1.270,00	
		Prezzo Retail con Iva Retail price with Vat				Marmo Marquina Nero lucido Black polished Marquina marble	MAR091L1	8
D17131V389B47 Versione piano in marmo Marble top version		1.535,00				Alluminio verniciato Grigio antracite Painted Aluminum Anthracite Grey	VER057O1	7
	Marmo Carrara bianco levigato Smooth white Carrara marble		MAR002O1	8			Prezzo Retail con Iva Retail price with Vat	
	Alluminio verniciato Grigio alluminio Painted Aluminum Grey al. color		VER044O3	7	D17430O451154	Contrappeso Counterbalance	135,00	
				v				
D17430O451154	Contrappeso Counterbalance	135,00						

TOKYO-POP

 by Tokujin Yoshioka
2002

Tavolo e tavolino/sgabello

Monoblocco in polietilene di colore bianco o nero antracite. Uso interno/esterno.

Table and coffee table/stool

White or black polyethylene monobloc. Indoor/outdoor use.

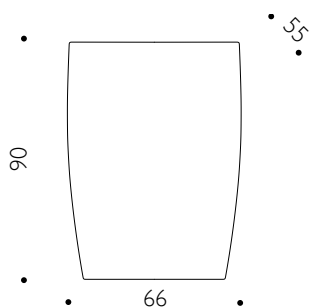

Tavolo
L. 66 P. 55 H. 90; P.L. 15 Kg. V. 0,366 mc
Table
W. 66 D. 55 H. 90; G.W. 15 Kg. V. 0,366 cbm

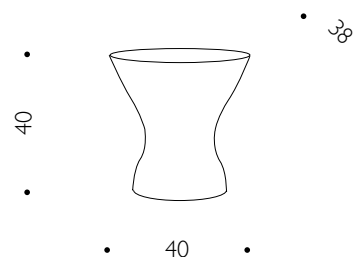

Tavolino/Sgabello
L. 40 P. 38 H. 40; P.L. 5 Kg. V. 0,075 mc
Table/Stool
W. 40 D. 38 H. 40; G.W. 5 Kg. V. 0,075 cbm



Codice Code	Prezzo Retail con Iva Retail price with Vat	Codice Code	Prezzo Retail con Iva Retail price with Vat		
D28371V278002	610,00	D28380H278002	220,00		
	Codice campione Sample code		Codice campione Sample code		
	Polietilene Bianco Ral 9016 White Ral 9016 Polyethylene PLA002O2	5		Polietilene Bianco Ral 9016 White Ral 9016 Polyethylene PLA002O2	5
D28371V278057	610,00	D28380H278057	220,00		
	Polietilene Nero antracite Ral 7016 Anthracite Black Ral 7016 Polyet.	5		Polietilene Nero antracite Ral 7016 Anthracite Black Ral 7016 Polyet. PLA091O5	5

PIAFFÈ

by Ludovica+Roberto
Palomba
2010

Tavolino

Monoblocco in polietilene disponibile in due varianti di colore: bianco o grigio chiaro.

Coffee table

White or light grey polyethylene monobloc.

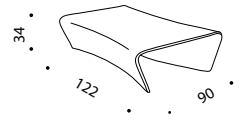

L. 242 P. 145 H. 82; seduta H. 40; P.L. 56 Kg; V. 3,6 mc
W. 242 D. 145 H. 82; seat H. 40; G.W. 56 Kg; V. 3,6 cbm



Codice
Code

D47704H278002

Prezzo Retail con Iva
Retail price with Vat

890,00

Codice campione
Sample code

PLA002O2

Campionario nr.
Sample box n.

5



Polietilene Bianco Ral 9016
White Ral 9016 Polyethylene

D47704H278045

890,00



Polietilene Grigio chiaro Ral 7047
Light Grey Ral 7047 Polyethylene

PLA045O2

TABELLA ABBINAMENTI
TABLE OF COMBINATIONS

TABELLA ABBINAMENTI/ *TABLE OF COMBINATIONS*

TESSUTO/ <i>FABRIC</i>	33 CUSCINI	BLOCCO	COCKY	COSTES	ELISA INDOOR
CAT. A - BONIFACIO	✓	✓	✓		✓
CAT. A - BONIFACIO - BS5852			✓		
CAT. A - MARSIGLIA	✓	✓	✓		✓
CAT. A - PETRA	✓	✓	✓		✓
CAT. A - DAMASCO	✓	✓	✓		✓
CAT. A - COLORADO	✓		✓		
CAT. B - BERLINO	✓	✓	✓		✓
CAT. B - BERLINO - BS5852			✓		
CAT. B - JAKARTA	✓	✓	✓		✓
CAT. B - GINEVRA	✓	✓	✓		✓
CAT. B - CIPRO OUTDOOR					
CAT. B - PANTELLERIA OUTDOOR					
CAT. C - LOIRA	✓	✓	✓		✓
CAT. C - LOIRA - BS5852			✓		
CAT. C - LISBONA	✓	✓	✓		✓
CAT. C - AMBURGO	✓	✓	✓		✓
CAT. C - AMBURGO - BS5852			✓		
CAT. C - BERNA		✓	✓		✓
CAT. C - BERNA - BS5852			✓		
CAT. C - BARCELLONA	✓	✓	✓		✓
CAT. C - BARCELLONA - BS5852			✓		

TABELLA ABBINAMENTI/ *TABLE OF COMBINATIONS*

TESSUTO/ <i>FABRIC</i>	33 CUSCINI	BLOCCO	COCKY	COSTES	ELISA INDOOR
CAT.C - MOSCA		✓	✓		
CAT.D - MALMÖ	✓	✓	✓		✓
CAT.E - DIVINA (KVADRAT)	✓	✓	✓		✓
CAT.E - DIVINA (KVADRAT) - BS5852			✓		
CAT.E - VENEZIA	✓	✓	✓		✓
CAT.E - PECHINO		✓	✓		
CAT.E - MONGOLIA		✓	✓		
PELLE/ <i>LEATHER</i>	33 CUSCINI	BLOCCO	COCKY	COSTES	ELISA INDOOR
CAT.P - NIAGARA			✓	✓	✓
CAT.P - NIAGARA- BS5852 Source 0 and Source 1			✓	✓	
CAT.O - RIO				✓	✓
CAT.O - RIO - BS5852				✓	
CAT.ZC - CHURCHILL			✓	✓	✓
CAT.ZC - CHURCHILL- BS5852 Source 0 and Source 1			✓	✓	
CAT.ZME - AMUR			✓		✓
CAT.ZME - AMUR - BS5852			✓		
CAT.ZS - SACRAMENTO					
CAT.ZA - PURUS			✓	✓	✓
CAT.ZA - PURUS - BS5852			✓	✓	

TABELLA ABBINAMENTI/ *TABLE OF COMBINATIONS*

TESSUTO/ <i>FABRIC</i>	ELISA OUTDOOR	FENIX	HALL	ITALIC	LA FRANCESA
CAT. A - BONIFACIO		✓	✓		✓
CAT. A - BONIFACIO - BS5852			✓		
CAT. A - MARSIGLIA		✓	✓		
CAT. A - PETRA		✓	✓		✓
CAT. A - DAMASCO		✓	✓		✓
CAT. A - COLORADO		✓	✓		
CAT. B - BERLINO		✓	✓		✓
CAT. B - BERLINO - BS5852			✓		
CAT. B - JAKARTA		✓	✓		✓
CAT. B - GINEVRA		✓	✓		
CAT. B - CIPRO OUTDOOR	✓				
CAT. B - PANTELLERIA OUTDOOR	✓				
CAT. C - LOIRA		✓	✓	✓	✓
CAT. C - LOIRA - BS5852			✓		
CAT. C - LISBONA		✓	✓		✓
CAT. C - AMBURGO		✓	✓		
CAT. C - AMBURGO - BS5852			✓		
CAT. C - BERNA		✓	✓		
CAT. C - BERNA - BS5852			✓		
CAT. C - BARCELLONA		✓	✓		
CAT. C - BARCELLONA - BS5852			✓		

TABELLA ABBINAMENTI/ *TABLE OF COMBINATIONS*

TESSUTO/ <i>FABRIC</i>	ELISA OUTDOOR	FENIX	HALL	ITALIC	LA FRANCESA
CAT.C - MOSCA					
CAT.D - MALMÖ		✓	✓		
CAT.E - DIVINA (KVADRAT)		✓	✓		✓
CAT.E - DIVINA (KVADRAT) - BS5852			✓		
CAT.E - VENEZIA		✓	✓	✓	
CAT.E - PECHINO					
CAT.E - MONGOLIA					
PELLE/ <i>LEATHER</i>	ELISA OUTDOOR	FENIX	HALL	ITALIC	LA FRANCESA
CAT.P - NIAGARA		✓	✓		✓
CAT.P - NIAGARA- BS5852 Source 0 and Source 1			✓		
CAT.O - RIO		✓	✓		✓
CAT.O - RIO - BS5852			✓		
CAT.ZC - CHURCHILL		✓	✓		✓
CAT.ZC - CHURCHILL- BS5852 Source 0 and Source 1			✓		
CAT.ZME - AMUR		✓	✓		✓
CAT.ZME - AMUR - BS5852			✓		
CAT.ZS - SACRAMENTO					
CAT.ZA - PURUS		✓	✓		✓
CAT.ZA - PURUS - BS5852			✓		

TABELLA ABBINAMENTI/ TABLE OF COMBINATIONS

TESSUTO/FABRIC	LIRICA/LIRICO	LISA	LOU EAT	LOU READ	LOU SPEAK
CAT. A - BONIFACIO	✓	✓			
CAT. A - BONIFACIO - BS5852					
CAT. A - MARSIGLIA	✓	✓			
CAT. A - PETRA	✓	✓			✓
CAT. A - DAMASCO	✓	✓			✓
CAT. A - COLORADO	✓	✓			
CAT. B - BERLINO	✓	✓			✓
CAT. B - BERLINO - BS5852					
CAT. B - JAKARTA	✓	✓			
CAT. B - GINEVRA	✓	✓			
CAT. B - CIPRO OUTDOOR					
CAT. B - PANTELLERIA OUTDOOR					
CAT. C - LOIRA	✓	✓			✓
CAT. C - LOIRA - BS5852					
CAT. C - LISBONA	✓	✓			✓
CAT. C - AMBURGO	✓	✓			
CAT. C - AMBURGO - BS5852					
CAT. C - BERNA		✓			
CAT. C - BERNA - BS5852					
CAT. C - BARCELLONA	✓	✓			
CAT. C - BARCELLONA - BS5852					

TABELLA ABBINAMENTI/ TABLE OF COMBINATIONS

TESSUTO/FABRIC	LIRICA/LIRICO	LISA	LOU EAT	LOU READ	LOU SPEAK
CAT.C - MOSCA					
CAT.D - MALMÖ	✓	✓			
CAT.E - DIVINA (KVADRAT)	✓	✓			
CAT.E - DIVINA (KVADRAT) - BS5852					
CAT.E - VENEZIA	✓	✓			✓
CAT.E - PECHINO					
CAT.E - MONGOLIA					
PELLE/LEATHER	LIRICA/LIRICO	LISA	LOU EAT	LOU READ	LOU SPEAK
CAT.P - NIAGARA	✓	✓	✓	✓	✓
CAT.P - NIAGARA- BS5852 Source 0 and Source 1					
CAT.O - RIO	✓	✓	✓	✓	✓
CAT.O - RIO - BS5852					
CAT.ZC - CHURCHILL	✓	✓	✓	✓	✓
CAT.ZC - CHURCHILL- BS5852 Source 0 and Source 1					
CAT.ZME - AMUR	✓	✓	✓	✓	✓
CAT.ZME - AMUR - BS5852					
CAT.ZS - SACRAMENTO				✓	
CAT.ZA - PURUS	✓	✓	✓	✓	✓
CAT.ZA - PURUS - BS5852					

TABELLA ABBINAMENTI/ *TABLE OF COMBINATIONS*

TESSUTO/ <i>FABRIC</i>	MOON	NEIL	PRATFALL	REVER	ROLY POLY
CAT. A - BONIFACIO	✓	✓		✓	✓
CAT. A - BONIFACIO - BS5852				✓	✓
CAT. A - MARSIGLIA	✓	✓		✓	✓
CAT. A - PETRA	✓	✓		✓	
CAT. A - DAMASCO	✓	✓		✓	
CAT. A - COLORADO	✓				
CAT. B - BERLINO	✓	✓		✓	✓
CAT. B - BERLINO - BS5852				✓	✓
CAT. B - JAKARTA	✓	✓		✓	✓
CAT. B - GINEVRA	✓	✓		✓	
CAT. B - CIPRO OUTDOOR					✓
CAT. B - PANTELLERIA OUTDOOR					✓
CAT. C - LOIRA	✓	✓		✓	
CAT. C - LOIRA - BS5852				✓	
CAT. C - LISBONA	✓	✓		✓	✓
CAT. C - AMBURGO	✓	✓		✓	✓
CAT. C - AMBURGO - BS5852				✓	✓
CAT. C - BERNA	✓	✓		✓	
CAT. C - BERNA - BS5852				✓	
CAT. C - BARCELLONA	✓	✓		✓	✓
CAT. C - BARCELLONA - BS5852				✓	✓

TABELLA ABBINAMENTI/ *TABLE OF COMBINATIONS*

TESSUTO/ <i>FABRIC</i>	MOON	NEIL	PRATFALL	REVER	ROLY POLY
CAT.C - MOSCA	✓		✓		
CAT.D - MALMÖ	✓	✓		✓	✓
CAT.E - DIVINA (KVADRAT)	✓	✓		✓	
CAT.E - DIVINA (KVADRAT) - BS5852				✓	
CAT.E - VENEZIA	✓	✓		✓	
CAT.E - PECHINO	✓				
CAT.E - MONGOLIA					
PELLE/ <i>LEATHER</i>	MOON	NEIL	PRATFALL	REVER	ROLY POLY
CAT.P - NIAGARA	✓	✓	✓	✓	
CAT.P - NIAGARA- BS5852 Source 0 and Source 1			✓	✓	
CAT.O - RIO	✓	✓		✓	
CAT.O - RIO - BS5852				✓	
CAT.ZC - CHURCHILL	✓	✓		✓	
CAT.ZC - CHURCHILL- BS5852 Source 0 and Source 1				✓	
CAT.ZME - AMUR	✓	✓			
CAT.ZME - AMUR - BS5852					
CAT.ZS - SACRAMENTO					
CAT.ZA - PURUS	✓	✓		✓	
CAT.ZA - PURUS - BS5852				✓	

TABELLA ABBINAMENTI/ *TABLE OF COMBINATIONS*

TESSUTO/ <i>FABRIC</i>	S.MARCO	S.MARCO LOUNGE	SOIREE	SOF SOF	TOTTORI
CAT.A - BONIFACIO	✓	✓	✓	✓	✓
CAT.A - BONIFACIO - BS5852	✓		✓		✓
CAT.A - MARSIGLIA	✓	✓	✓	✓	✓
CAT.A - PETRA	✓	✓	✓	✓	✓
CAT.A - DAMASCO	✓	✓	✓	✓	✓
CAT.A - COLORADO	✓	✓			
CAT.B - BERLINO	✓	✓	✓	✓	✓
CAT.B - BERLINO - BS5852	✓		✓		✓
CAT.B - JAKARTA	✓	✓	✓	✓	✓
CAT.B - GINEVRA	✓	✓	✓	✓	✓
CAT.B - CIPRO OUTDOOR					
CAT.B - PANTELLERIA OUTDOOR					
CAT.C - LOIRA	✓	✓	✓	✓	✓
CAT.C - LOIRA - BS5852	✓				
CAT.C - LISBONA	✓	✓	✓	✓	✓
CAT.C - AMBURGO	✓	✓	✓	✓	✓
CAT.C - AMBURGO - BS5852	✓				✓
CAT.C - BERNA				✓	✓
CAT.C - BERNA - BS5852			✓		✓
CAT.C - BARCELLONA			✓	✓	✓
CAT.C - BARCELLONA - BS5852			✓		✓

TABELLA ABBINAMENTI/ *TABLE OF COMBINATIONS*

TESSUTO/ <i>FABRIC</i>	S.MARCO	S.MARCO LOUNGE	SOIREE	SOF SOF	TOTTORI
CAT.C - MOSCA					
CAT.D - MALMÖ	✓	✓	✓	✓	✓
CAT.E - DIVINA (KVADRAT)	✓	✓	✓	✓	✓
CAT.E - DIVINA (KVADRAT) - BS5852	✓		✓		✓
CAT.E - VENEZIA	✓	✓		✓	
CAT.E - PECHINO					
CAT.E - MONGOLIA					
PELLE/ <i>LEATHER</i>	S.MARCO	S.MARCO LOUNGE	SOIREE	SOF SOF	TOTTORI
CAT.P - NIAGARA	✓	✓	✓	✓	
CAT.P - NIAGARA - BS5852 Source 0 and Source 1	✓		✓		
CAT.O - RIO	✓	✓	✓		✓
CAT.O - RIO - BS5852	✓		✓		✓
CAT.ZC - CHURCHILL	✓	✓	✓		✓
CAT.ZC - CHURCHILL- BS5852 Source 0 and Source 1	✓		✓		✓
CAT.ZME - AMUR	✓	✓			✓
CAT.ZME - AMUR - BS5852	✓				✓
CAT.ZS - SACRAMENTO					
CAT.ZA - PURUS	✓	✓	✓		✓
CAT.ZA - PURUS - BS5852	✓		✓		✓

TABELLA ABBINAMENTI/ *TABLE OF COMBINATIONS*

TESSUTO/ <i>FABRIC</i>	VERLAINE	VIGILIUS	WOW		
CAT.A - BONIFACIO	✓	✓	✓		
CAT.A - BONIFACIO - BS5852					
CAT.A - MARSIGLIA	✓	✓	✓		
CAT.A - PETRA	✓	✓	✓		
CAT.A - DAMASCO	✓	✓	✓		
CAT.A - COLORADO		✓	✓		
CAT.B - BERLINO	✓	✓	✓		
CAT.B - BERLINO - BS5852					
CAT.B - JAKARTA		✓	✓		
CAT.B - GINEVRA		✓	✓		
CAT.B - CIPRO OUTDOOR					
CAT.B - PANTELLERIA OUTDOOR					
CAT.C - LOIRA		✓	✓		
CAT.C - LOIRA - BS5852					
CAT.C - LISBONA		✓	✓		
CAT.C - AMBURGO		✓	✓		
CAT.C - AMBURGO - BS5852					
CAT.C - BERNA		✓	✓		
CAT.C - BERNA - BS5852					
CAT.C - BARCELLONA		✓	✓		
CAT.C - BARCELLONA - BS5852					

TABELLA ABBINAMENTI/ *TABLE OF COMBINATIONS*

TESSUTO/ <i>FABRIC</i>	VERLAINE	VIGILIUS	WOW		
CAT.C - MOSCA					
CAT.D - MALMÖ	✓	✓	✓		
CAT.E - DIVINA (KVADRAT)	✓	✓	✓		
CAT.E - DIVINA (KVADRAT) - BS5852					
CAT.E - VENEZIA	✓	✓	✓		
CAT.E - PECHINO					
CAT.E - MONGOLIA					
PELLE/ <i>LEATHER</i>	VERLAINE	VIGILIUS	WOW		
CAT.P - NIAGARA	✓	✓	✓		
CAT.P - NIAGARA- BS5852 Source 0 and Source 1					
CAT.O - RIO	✓	✓	✓		
CAT.O - RIO - BS5852					
CAT.ZC - CHURCHILL		✓	✓		
CAT.ZC - CHURCHILL- BS5852 Source 0 and Source 1					
CAT.ZME - AMUR		✓	✓		
CAT.ZME - AMUR - BS5852					
CAT.ZS - SACRAMENTO					
CAT.ZA - PURUS		✓	✓		
CAT.ZA - PURUS - BS5852					













TESSUTI-PELLI/MATERIALI
FABRICS-LEATHER/MATERIAL

CAT.A

700 COTONE BONIFACIO - COTTON BONIFACIO

Composizione/Composition: 100% CO Altezza/Height:138/140 cm. Peso/Weight: 560gr. Abrasione/Abrasion: 20.000 Martindale (uso pubblico, uso regolare/public use, regular use).
BS5852:0 1979 ign cigarette test pass.

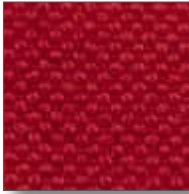

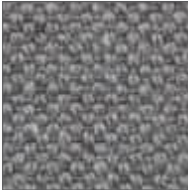
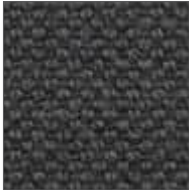
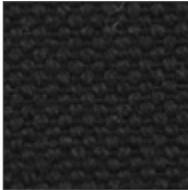
	002 BIANCO WHITE		004 AVORIO IVORY		016 TORTORA TAUPE		080 MARRONE CHIARO LIGHT BROWN
	019 OCRA OCHRE		062 VERDE CHIARO LIGHT GREEN		066 VERDE SCURO DARK GREEN		H03 VERDE ACQUA TEAL
	061 AZZURRO INDACO INDIGO BLUE		024 ROSA PINK		039 ROSSO RED		040 BORDEAUX BURGUNDY
	072 BLU BLUE		045 GRIGIO CHIARO LIGHT GREY		050 GRIGIO SCURO DARK GREY		091 NERO BLACK

I colori sono indicativi. Non è possibile garantire uniformità di tono nella tintura dei lotti di tessuto. Resta inteso che lievi differenze di colore verranno accettate al momento dell'ordine.

The colors are just indicative. Actually a steady tone of lots cannot be guaranteed. It remains understood that any slight colour difference will be accepted in case an order is placed.

CAT.A

720 COTONE BONIFACIO/FRASSINO - COTTON BONIFACIO/ASH

La Francesea

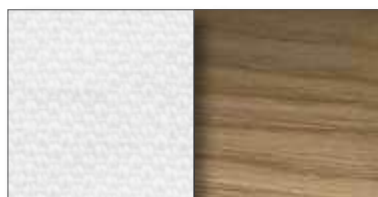

177
BIANCO/NATURALE
WHITE/NATURAL

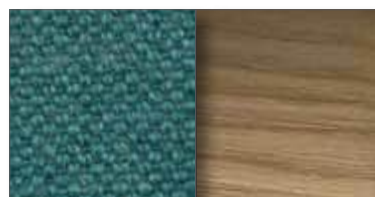

H04
VERDE ACQUA/NATURALE
AQUA GREEN/NATURAL



172
AVORIO/NATURALE
IVORY/NATURAL

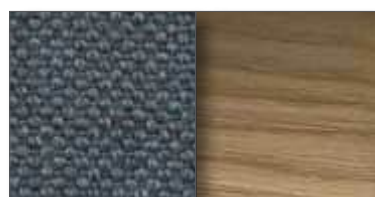

174
AZZURRO INDACO/NATURALE
INDIGO BLUE/NATURAL

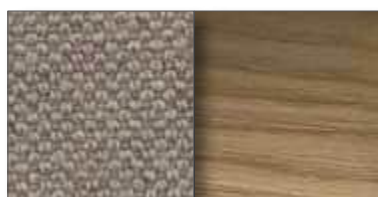

224
TORTORA/NATURALE
TAUPE/NATURAL

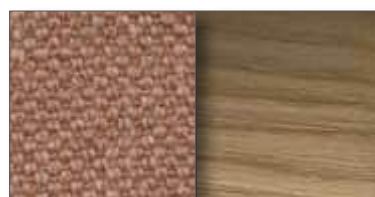

216
ROSA/NATURALE
PINK/NATURAL

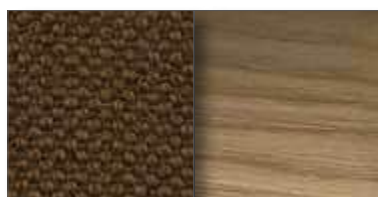

204
MARRONE CHIARO/NATURALE
LIGHT BROWN/NATURAL

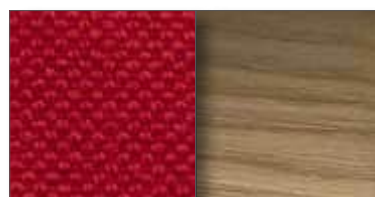

219
ROSSO/NATURALE
RED/NATURAL

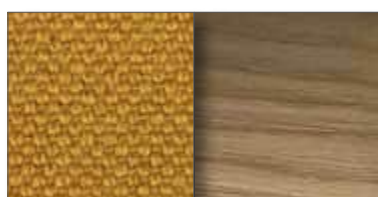

189
OCRA/NATURALE
OCHRE/NATURAL

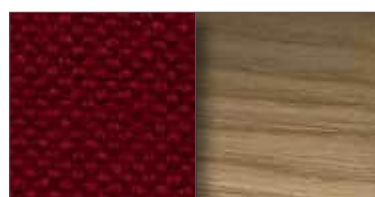

183
BORDEAUX/NATURALE
BURGUNDY/NATURAL

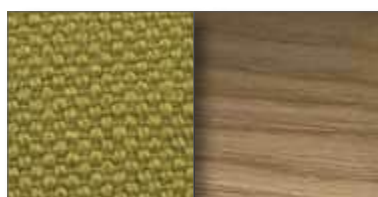

226
VERDE CHIARO/NATURALE
LIGHT GREEN/NATURAL

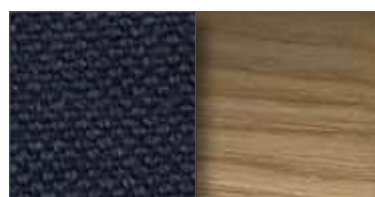

182
BLU/NATURALE
BLEU/NATURAL

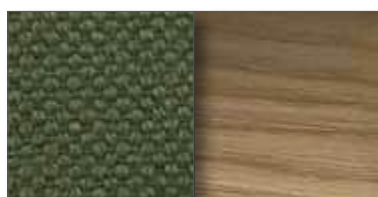

227
VERDE SCURO/NATURALE
DARK GREEN/NATURAL

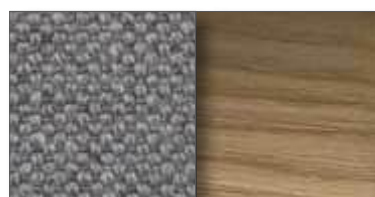

197
GRIGIO CHIARO/NATURALE
LIGHT GREY/NATURAL

CAT.A

720 COTONE BONIFACIO/FRASSINO - COTTON BONIFACIO/ASH

La Francesca



191

GRIGIO SCURO/NATURALE

DARK GREY/NATURAL

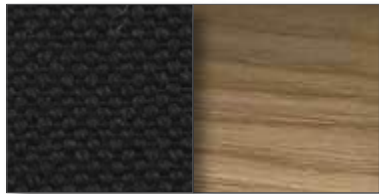

207

NERO/NATURALE

BLACK/NATURAL

CAT.A

720 COTONE BONIFACIO/FRASSINO - COTTON BONIFACIO/ASH

La Francesea



230
BIANCO/EBANIZZATO
WHITE/EBONIZED

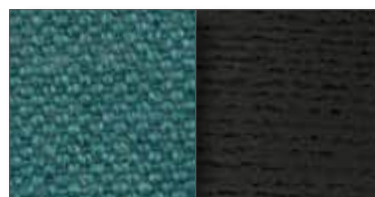

H05
VERDE ACQUA/EBANIZZATO
AQUA GREEN/EBONIZED

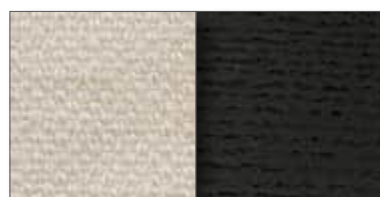

233
AVORIO/EBANIZZATO
IVORY/EBONIZED



235
AZZURRO INDACO/EBANIZZATO
INDIGO BLUE/EBONIZED



286
TORTORA/EBANIZZATO
TAUPE/EBONIZED



277
ROSA/EBANIZZATO
PINK/EBONIZED

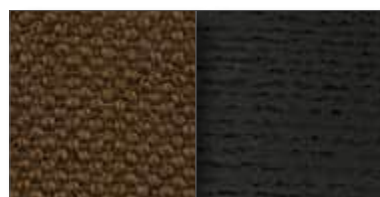

263
MARRONE CHIARO/EBANIZZATO
LIGHT BROWN/EBONIZED

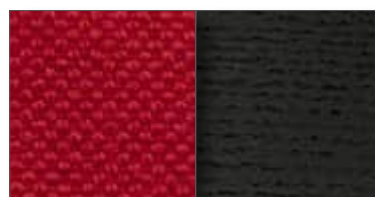

280
ROSSO/EBANIZZATO
RED/EBONIZED



249
OCRA/EBANIZZATO
OCHRE/EBONIZED

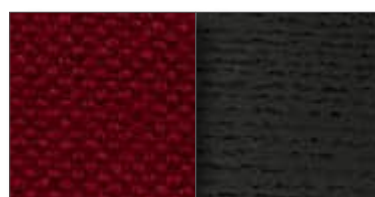

243
BORDEAUX/EBANIZZATO
BURGUNDY/EBONIZED



288
VERDE CHIARO/EBANIZZATO
LIGHT GREEN/EBONIZED

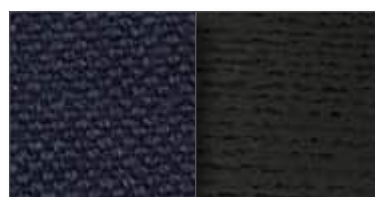

242
BLU/EBANIZZATO
BLUE/EBONIZED

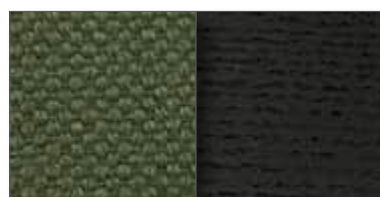

289
VERDE SCURO/EBANIZZATO
DARK GREEN/EBONIZED

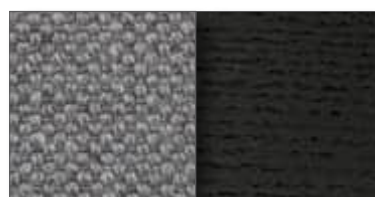

256
GIRGIO CHIARO/EBANIZZATO
LIGHT GREY/EBONIZED

CAT.A

720 COTONE BONIFACIO/FRASSINO - COTTON BONIFACIO/ASH

La Francesea

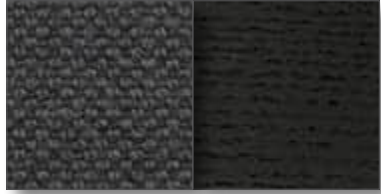

260

GRIGIO SCURO/EBANIZZATO

DARK GREY/EBONIZED

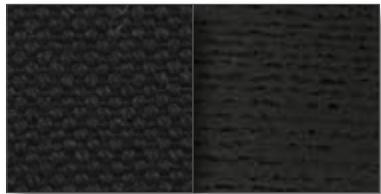

267

NERO/EBANIZZATO

BLACK/EBONIZED

CAT.A

722 COTONE BONIFACIO/ACCIAIO VERNICIATO - COTTON BONIFACIO/PAINTED STEEL

Sof Sof, 33 Cuscini

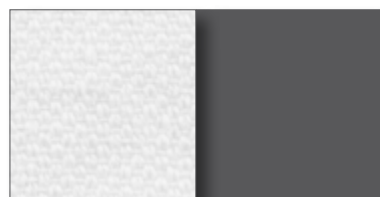

328
BIANCO/GRAFITE
WHITE|GRAPHITE

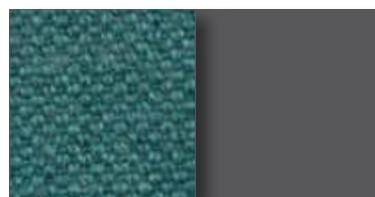

H07
VERDE ACQUA/GRAFITE
AQUA GREEN|GRAPHITE

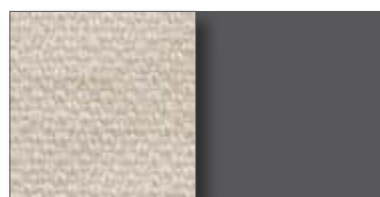

322
AVORIO/GRAFITE
IVORY|GRAPHITE

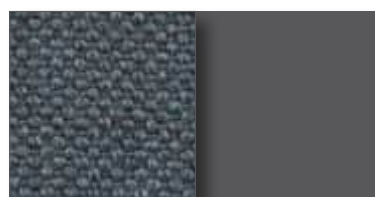

325
AZZURRO INDACO/GRAFITE
INDIGO BLUE|GRAPHITE

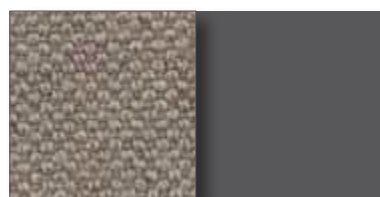

378
TORTORA/GRAFITE
TAUPE|GRAPHITE

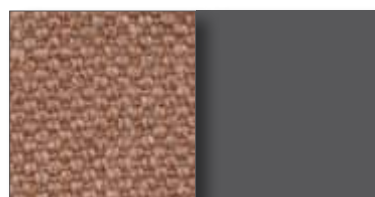

370
ROSA/GRAFITE
PINK|GRAPHITE

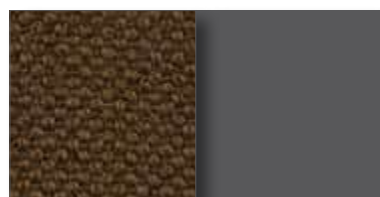

357
MARRONE CHIARO/GRAFITE
LIGHT GREEN|GRAPHITE

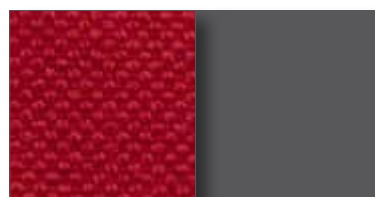

374
ROSSO/GRAFITE
RED|GRAPHITE

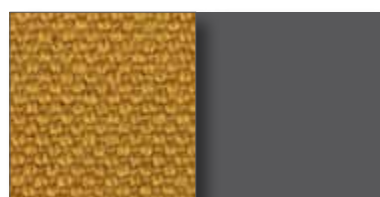

340
OCRA/GRAFITE
OCHRE|GRAPHITE

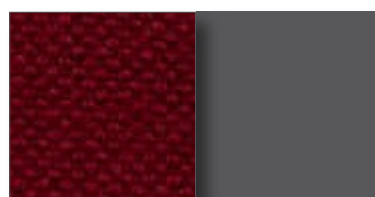

337
BORDEAUX/GRAFITE
BORDEAUX|GRAPHITE

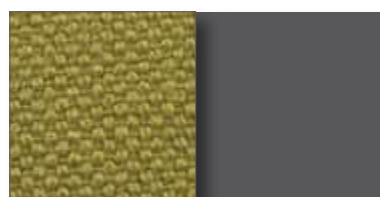

380
VERDE CHIARO/GRAFITE
LIGHT YELLOW|GRAPHITE

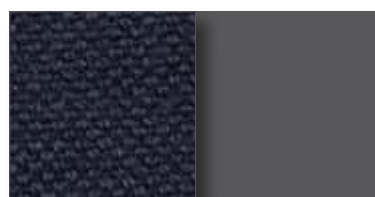

336
BLU/GRAFITE
BLUE|GRAPHITE

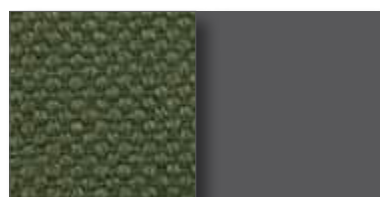

384
VERDE SCURO/GRAFITE
DARK GREEN|GRAPHITE

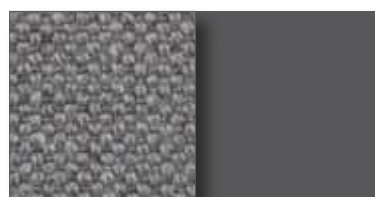

348
GRIGIO CHIARO/GRAFITE
LIGHT GREY|GRAPHITE

CAT.A

722 COTONE BONIFACIO/ACCIAIO VERNICIATO - COTTON BONIFACIO/PAINTED STEEL

Sof Sof, 33 Cuscini

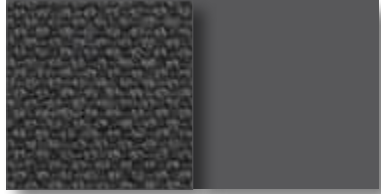

353

GRIGIO SCURO/GRAFITE

DARK GREY|GRAPHITE

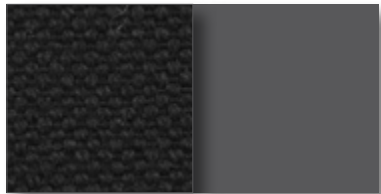

361

NERO/GRAFITE

BLACK|GRAPHITE

CAT.A

722 COTONE BONIFACIO/ACCIAIO VERNICIATO - COTTON BONIFACIO/PAINTED STEEL

Elisa

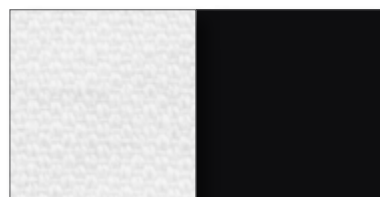

393
BIANCO/NERO MARRONE
WHITE/BLACK BROWN

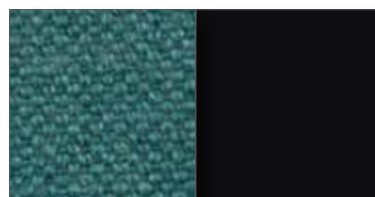

H08
VERDE ACQUA/NERO MARRONE
AQUA GREEN/BLACK BROWN

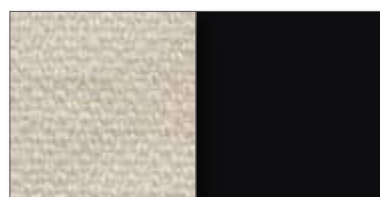

388
AVORIO/NERO MARRONE
IVORY/BLACK BROWN

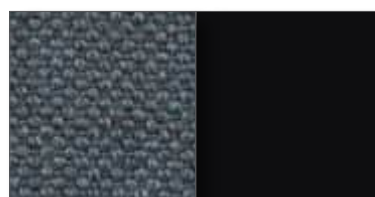

390
AZZURRO INDACO/NERO MARRONE
INDIGO BLUE/BLACK BROWN

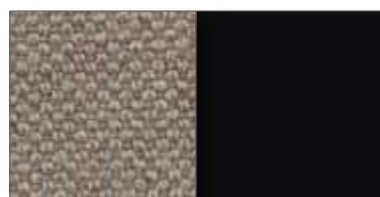

427
TORTORA/NERO MARRONE
TAUPE/BLACK BROWN

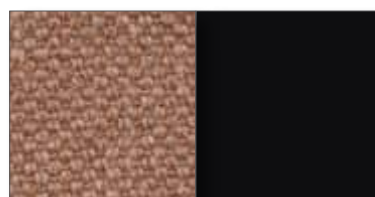

422
ROSA/NERO MARRONE
ROSA/BLACK BROWN

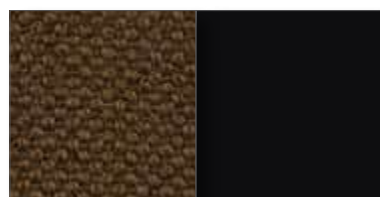

414
MARRONE CHIARO/NERO MARRONE
LIGHT BROWN/BLACK BROWN

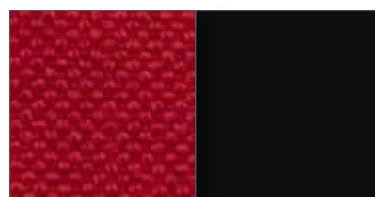

424
ROSSO/NERO MARRONE
RED/BLACK BROWN

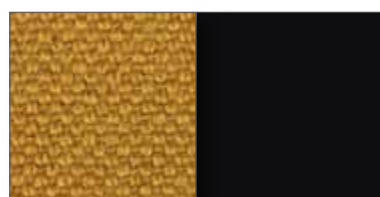

403
OCRA/NERO MARRONE
OCHRE/BLACK BROWN

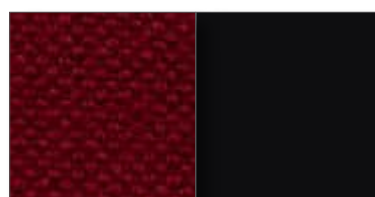

401
BORDEAUX/NERO MARRONE
BORDEAUX/BLACK BROWN

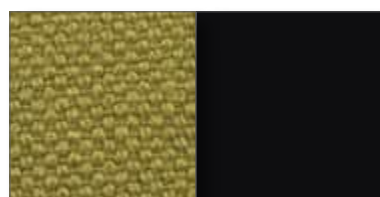

429
VERDE CHIARO/NERO MARRONE
LIGHT GREEN/BLACK BROWN

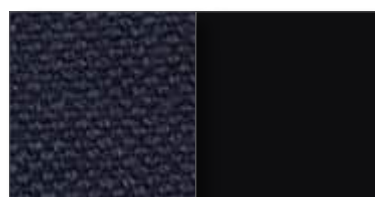

400
BLU/NERO MARRONE
BLUE/BLACK BROWN

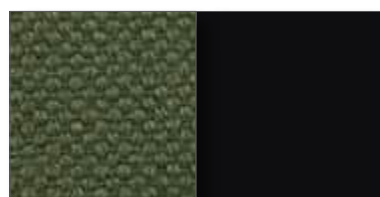

432
VERDE SCURO/NERO MARRONE
DARK GREEN/BLACK BROWN

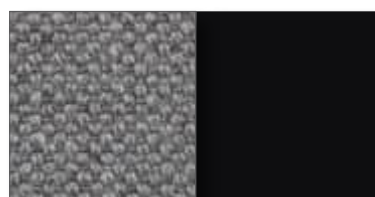

407
GRIGIO CHIARO/NERO MARRONE
LIGHT GREY/BLACK BROWN

CAT.A

722 COTONE BONIFACIO/ACCIAIO VERNICIATO - COTTON BONIFACIO/PAINTED STEEL

Elisa

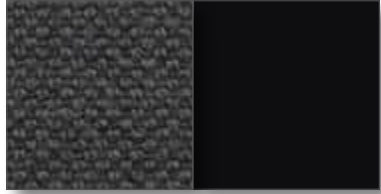

411

GRIGIO SCURO/NERO MARRONE
DARK GREY|BLACK BROWN

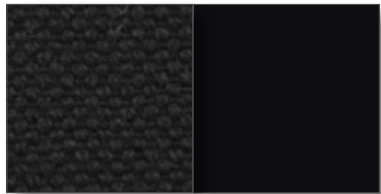

417

NERO/NERO MARRONE
BLACK|BLACK BROWN

CAT.A

722 COTONE BONIFACIO/ACCIAIO VERNICIATO - COTTON BONIFACIO/PAINTED STEEL

Fenix

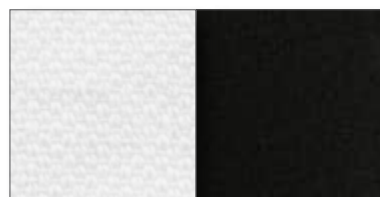

442
BIANCO/PELTRO BRONZATO
WHITE|BRONZE PEWTER



H09
VERDE ACQUA/PELTRO BRONZATO
AQUA GREEN|BRONZE PEWTER



436
AVORIO/PELTRO BRONZATO
IVORY|BRONZE PEWTER



439
AZZURRO INDACO/PELTRO BRONZATO
INDIGO BLUE|BRONZE PEWTER

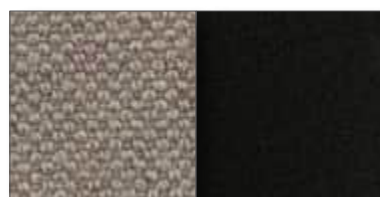

501
TORTORA/PELTRO BRONZATO
TAUPE|BRONZE PEWTER



490
ROSA/PELTRO BRONZATO
ROSA|BRONZE PEWTER



475
MARRONE CHIARO/PELTRO BRONZATO
LIGHT BROWN|BRONZE PEWTER

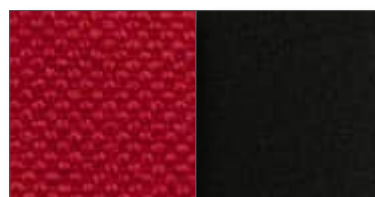

494
ROSSO/PELTRO BRONZATO
RED|BRONZE PEWTER



458
OCRA/PELTRO BRONZATO
OCHRE|BRONZE PEWTER

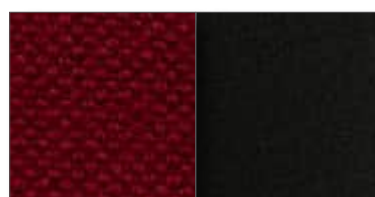

451
BORDEAUX/PELTRO BRONZATO
BURGUNDY|BRONZE PEWTER



104
VERDE CHIARO/PELTRO BRONZATO
LIGHT GREEN|BRONZE PEWTER

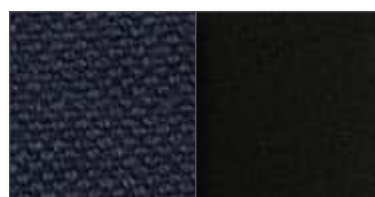

450
BLU/PELTRO BRONZATO
BLU|BRONZE PEWTER

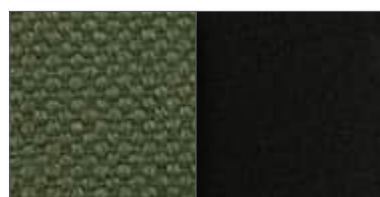

507
VERDE SCURO/PELTRO BRONZATO
DARK GREEN|BRONZE PEWTER



466
GRIGIO CHIARO/PELTRO BRONZATO
LIGHT GREY|BRONZE PEWTER

CAT.A

722 COTONE BONIFACIO/ACCIAIO VERNICIATO - COTTON BONIFACIO/PAINTED STEEL

Fenix



471

GRIGIO SCURO/PELTRO BRONZATO
DARK GREY|BRONZE PEWTER

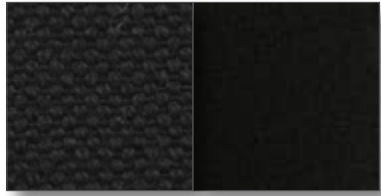

479

NERO/PELTRO BRONZATO
BLACK|BRONZE PEWTER

CAT.A

722 COTONE BONIFACIO/ACCIAIO VERNICIATO - COTTON BONIFACIO/PAINTED STEEL

Cocky



596
BIANCO/NERO
WHITE/BLACK

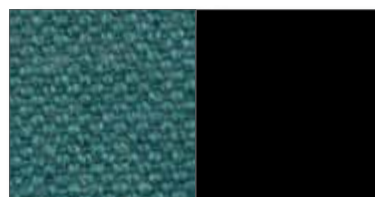

H22
VERDE ACQUA/NERO
AQUA GREEN/BLACK



590
AVORIO/NERO
IVORY/BLACK

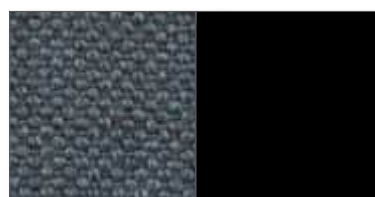

593
AZZURRO INDACO/NERO
INDIGO BLUE/BLACK

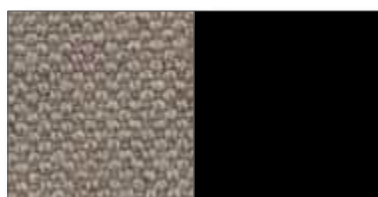

655
TORTORA/NERO
TAUPE/BLACK

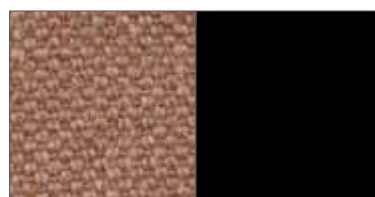

643
ROSA/NERO
ROSA/BLACK

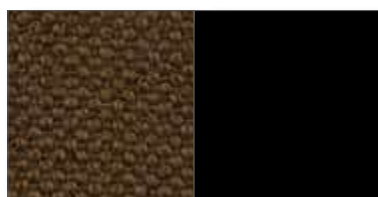

628
MARRONE CHIARO/NERO
LIGHT BROWN/BLACK

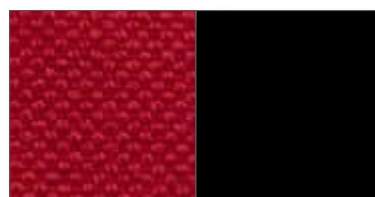

647
ROSSO/NERO
RED/BLACK

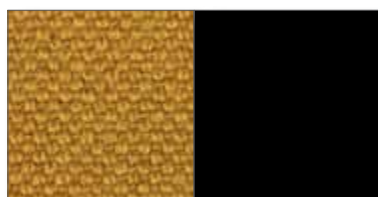

612
OCRA/NERO
OCHRE/BLACK

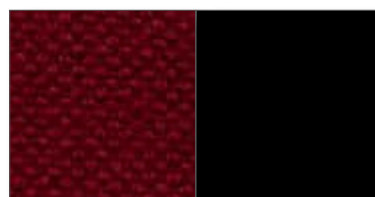

605
BORDEAUX/NERO
BURGUNDY/BLACK

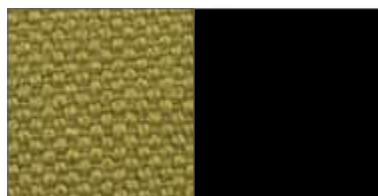

657
VERDE CHIARO/NERO
LIGHT GREEN/BLACK

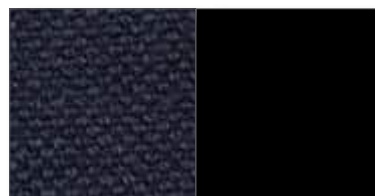

604
BLU/NERO
BLU/BLACK

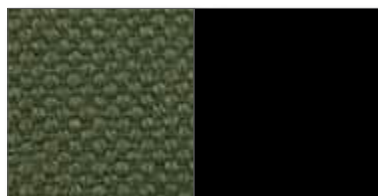

661
VERDE SCURO/NERO
DARK GREEN/BLACK



620
GRIGIO CHIARO/NERO
LIGHT GREY/BLACK

CAT.A

722 COTONE BONIFACIO/ACCIAIO VERNICIATO - COTTON BONIFACIO/PAINTED STEEL

Cocky

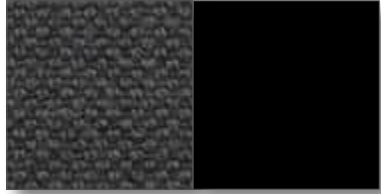

625
GRIGIO SCURO/NERO
DARK GREY/BLACK

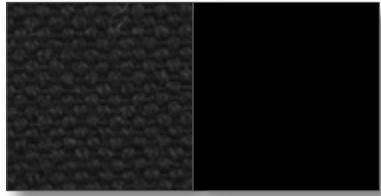

632
NERO/NERO
BLACK/BLACK

CAT.A

723 COTONE BONIFACIO/ALLUMINIO LUCIDATO - COTTON BONIFACIO/POLISHED ALUMINUM

Cocky

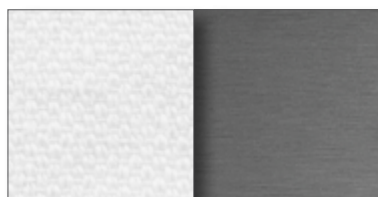

531
BIANCO/ALLUMINIO
WHITE/ALUMINUM

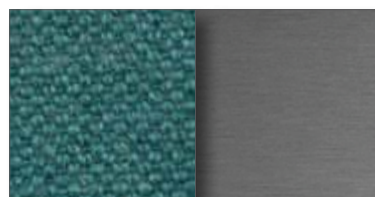

H23
VERDE ACQUA/ALLUMINIO
AQUA GREEN/ALUMINUM

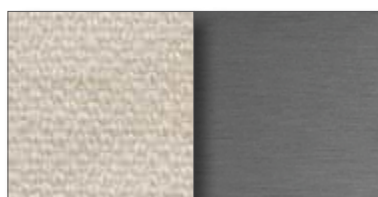

526
AVORIO/ALLUMINIO
IVORY/ALUMINUM

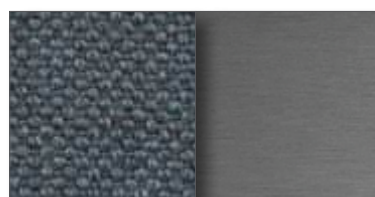

528
AZZURRO INDACO/ALLUMINIO
INDIGO BLUE/ALUMINUM

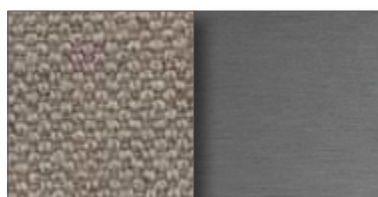

582
TORTORA/ALLUMINIO
TAUPE/ALUMINUM

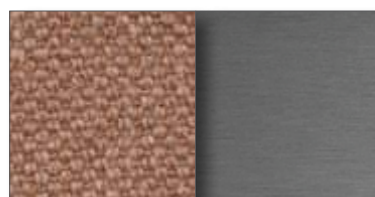

572
ROSA/ALLUMINIO
PINK/ALUMINUM

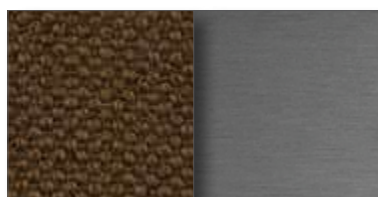

557
MARRONE CHIARO/ALLUMINIO
LIGHT BROWN/ALUMINUM

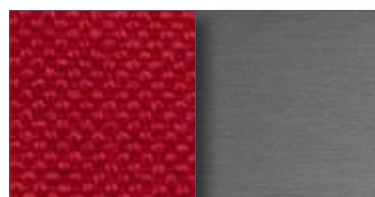

575
ROSSO/ALLUMINIO
RED/ALUMINUM

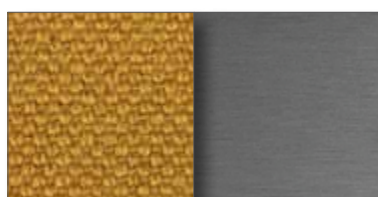

543
OCRA/ALLUMINIO
OCHRE/ALUMINUM

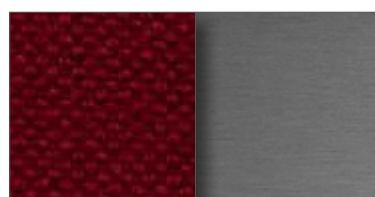

537
BORDEAUX/ALLUMINIO
BURGUNDY/ALUMINUM

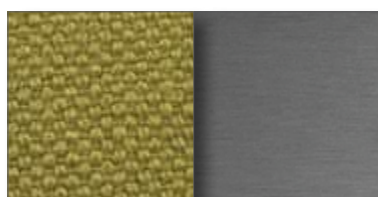

584
VERDE CHIARO/ALLUMINIO
LIGHT GREEN/ALUMINUM

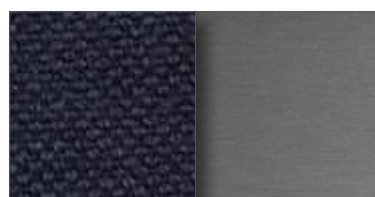

536
BLU/ALLUMINIO
BLUE/ALUMINUM

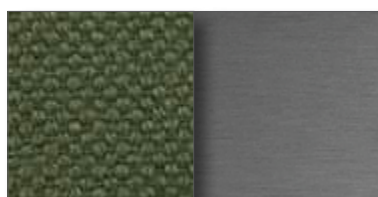

585
VERDE SCURO/ALLUMINIO
DARK GREEN/ALUMINUM

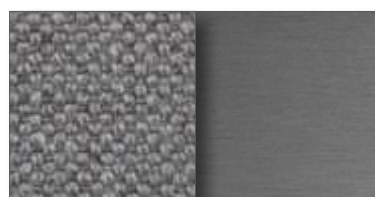

550
GRIGIO CHIARO/ALLUMINIO
LIGHT GREY/ALUMINUM

CAT.A

723 COTONE BONIFACIO/ALLUMINIO LUCIDATO - *COTTON BONIFACIO/POLISHED ALUMINUM*

Cocky

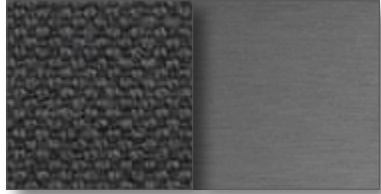

554

GRIGIO SCURO/ALLUMINIO
DARK GREY/ALUMINUM

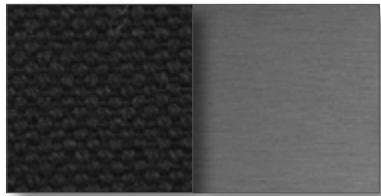

561

NERO/ALLUMINIO
BLACK/ALUMINUM

CAT.A

724 COTONE BONIFACIO/ALLUMINIO VERNICIATO - COTTON BONIFACIO/PAINTED ALUMINUM

Lirica, Lirico

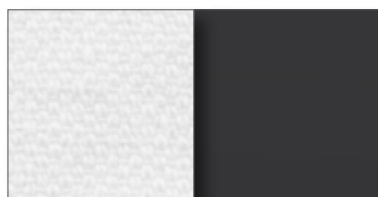

596
BIANCO/NERO
WHITE/BLACK

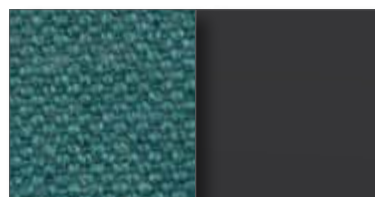

H22
VERDE ACQUA/NERO
AQUA GREEN/BLACK

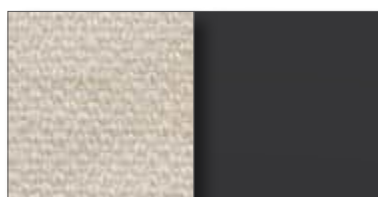

590
AVORIO/NERO
IVORY/BLACK

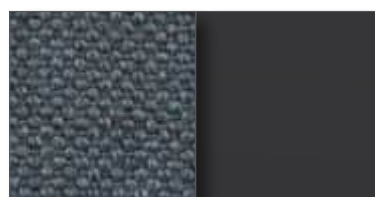

593
AZZURRO INDACO/NERO
INDIGO BLUE/BLACK

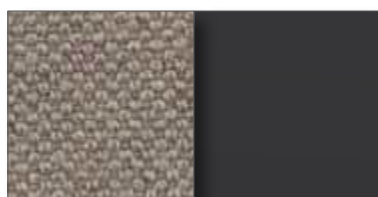

655
TORTORA/NERO
TAUPE/BLACK

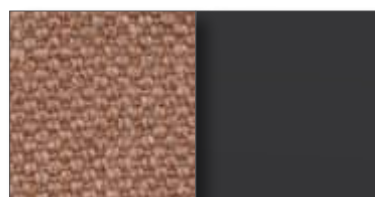

643
ROSA/NERO
PINK/BLACK

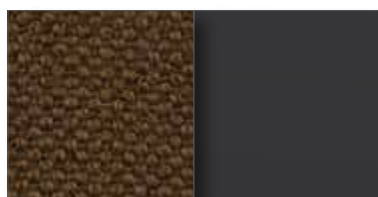

414
MARRONE CHIARO/NERO
LIGHT BROWN/BLACK

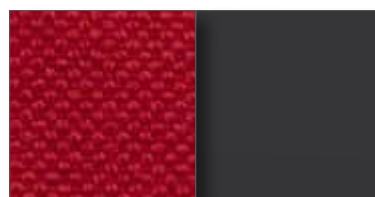

647
ROSSO/NERO
RED/BLACK

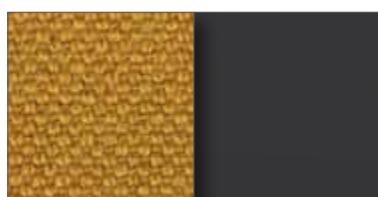

612
OCRA/NERO
OCHRE/BLACK

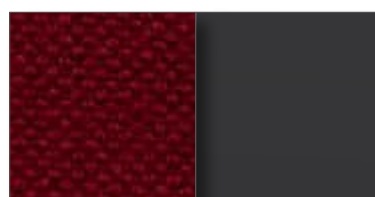

605
BORDEAUX/NERO
BURGUNDY/BLACK

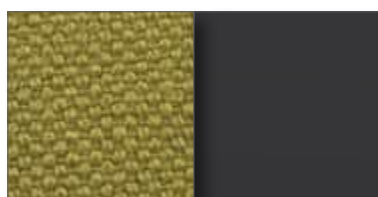

657
VERDE CHIARO/NERO
LIGHT GREEN/BLACK

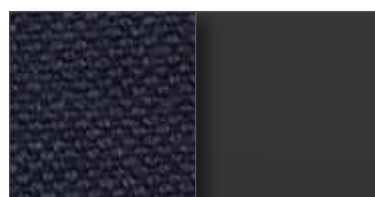

604
BLU/NERO
BLUE/BLACK

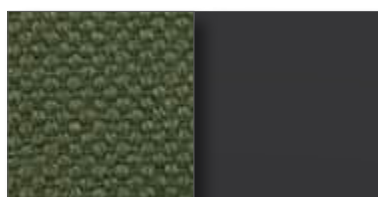

661
VERDE SCURO/NERO
DARK GREEN/BLACK

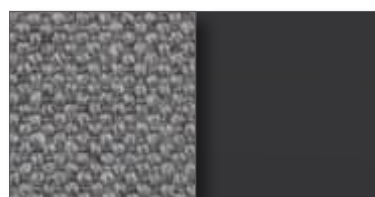

620
GRIGIO CHIARO/NERO
LIGHT GREY/BLACK

CAT.A

724 COTONE BONIFACIO/ALLUMINIO VERNICIATO - COTTON BONIFACIO/PAINTED ALUMINUM

Lirica, Lirico



625
GRIGIO SCURO/NERO
DARK GREY/BLACK

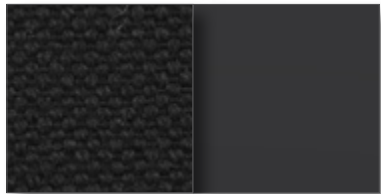

632
NERO/NERO
BLACK/BLACK

CAT.A

724 COTONE BONIFACIO/ALLUMINIO VERNICIATO - COTTON BONIFACIO/PAINTED ALUMINUM

Lirica, Lirico



722
BIANCO/ARGENTO
WHITE/SILVER



H15
VERDE ACQUA/ARGENTO
AQUA GREEN/SILVER



716
AVORIO/ARGENTO
IVORY/SILVER



719
AZZURRO INDACO/ARGENTO
INDIGO BLUE/SILVER



782
TORTORA/ARGENTO
TAUPE/SILVER



770
ROSA/ARGENTO
PINK/SILVER



755
MARRONE CHIARO/ARGENTO
LIGHT BROWN/SILVER



774
ROSSO/ARGENTO
RED/SILVER



738
OCRA/ARGENTO
OCHRE/SILVER



731
BORDEAUX/ARGENTO
BURGUNDY/SILVER



784
VERDE CHIARO/ARGENTO
LIGHT GREEN/SILVER



730
BLU/ARGENTO
BLUE/SILVER



788
VERDE SCURO/ARGENTO
DARK GREEN/SILVER



746
GRIGIO CHIARO/ARGENTO
LIGHT GREY/SILVER

CAT.A

724 COTONE BONIFACIO/ALLUMINIO VERNICIATO - COTTON BONIFACIO/PAINTED ALUMINUM

Lirica, Lirico



751
GRIGIO SCURO/ARGENTO
DARK GREY/SILVER



759
NERO/ARGENTO
BLACK/SILVER

CAT.A

727 COTONE BONIFACIO/FAGGIO LACCATO - COTTON BONIFACIO/LACQUERED BEECH

S.Marco, S.Marco Lounge

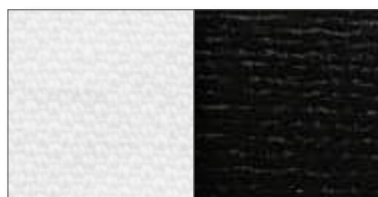

596
BIANCO/NERO
WHITE/BLACK

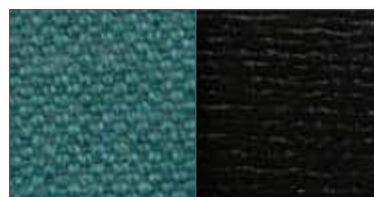

H22
VERDE ACQUA/NERO
AQUA GREEN/BLACK

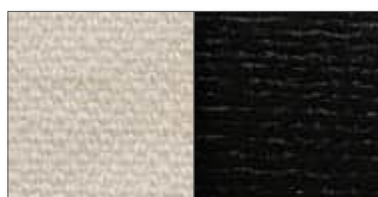

590
AVORIO/NERO
IVORY/BLACK



593
AZZURRO INDACO/NERO
INDIGO BLUE/BLACK



655
TORTORA/NERO
TAUPE/BLACK



643
ROSA/NERO
ROSA/BLACK

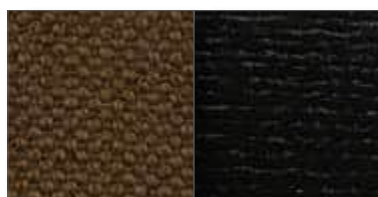

414
MARRONE CHIARO/NERO
LIGHT BROWN/BLACK

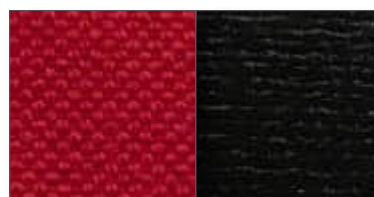

647
ROSSO/NERO
RED/BLACK



612
OCRA/NERO
OCHRE/BLACK

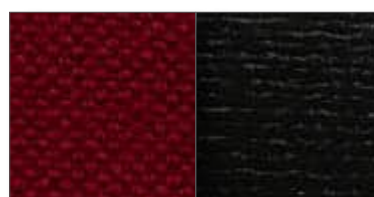

605
BORDEAUX/NERO
BURGUNDY/BLACK

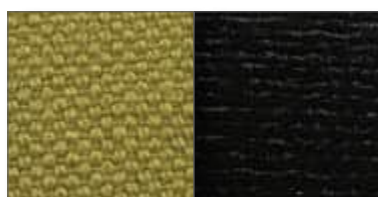

657
VERDE CHIARO/NERO
LIGHT GREEN/BLACK

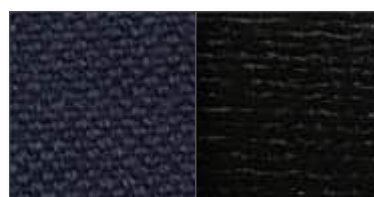

604
BLU/NERO
BLUE/BLACK

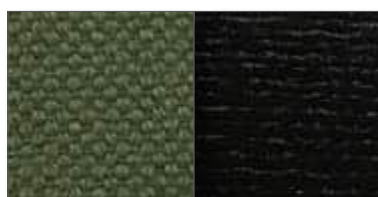

661
VERDE SCURO/NERO
DARK GREEN/BLACK



620
GRIGIO CHIARO/NERO
LIGHT GREY/BLACK

CAT.A

727 COTONE BONIFACIO/FAGGIO LACCATO - COTTON BONIFACIO/LACQUERED BEECH

S.Marco, S.Marco Lounge



625
GRIGIO SCURO/NERO
DARK GREY/BLACK

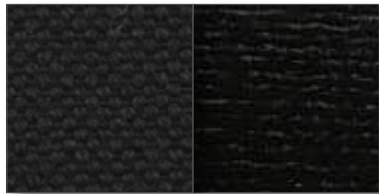

632
NERO/NERO
BLACK/BLACK

CAT.A

728 PU RIGIDO VERNICIATO/COTONE BONIFACIO/ACCIAIO CROMATO
STIFF PAINTED PU/COTTON BONIFACIO/CHROMED STEEL

Moon

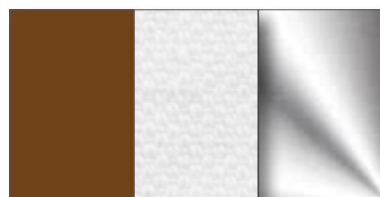

864
MATTONE/BIANCO/CROMO
BRICK RED/WHITE/CHROME

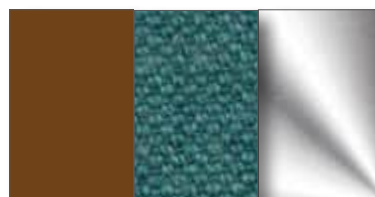

H24
MATTONE/VERDE ACQUA/CROMO
BRICK RED/AQUA GREEN/CHROME

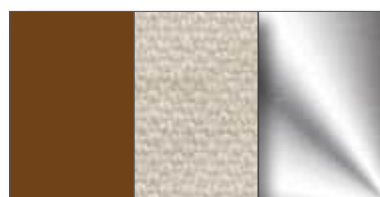

859
MATTONE/AVORIO/CROMO
BRICK RED/IVORY/CHROME

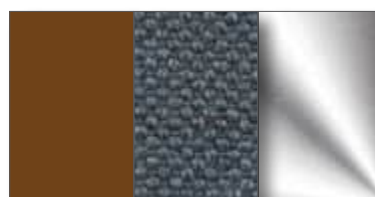

861
MATTONE/AZZURRO INDACO/CROMO
BRICK RED/INDIGO BLUE/CHROME

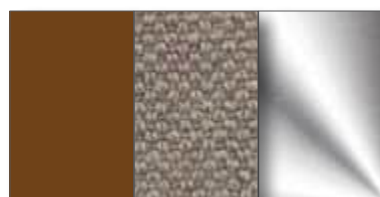

920
MATTONE/TORTORA/CROMO
BRICK RED/TAUPE/CHROME

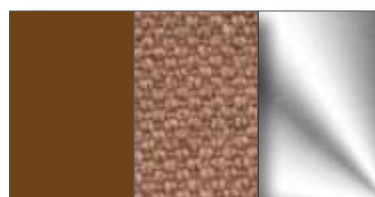

909
MATTONE/ROSA/CROMO
BRICK RED/PINK/CHROME

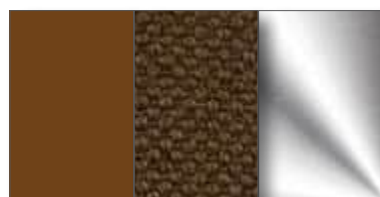

895
MATTONE/MARRONE CH./CROMO
BRICK RED/LIGHT BROWN/CHROME

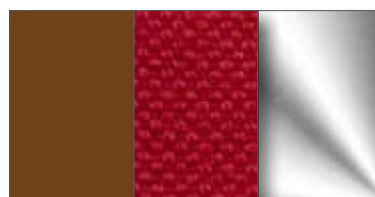

913
MATTONE/ROSSO/CROMO
BRICK RED/RED/CHROME

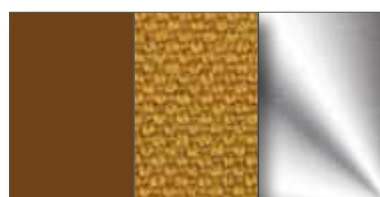

878
MATTONE/OCRA/CROMO
BRICK RED/OCHRE/CHROME

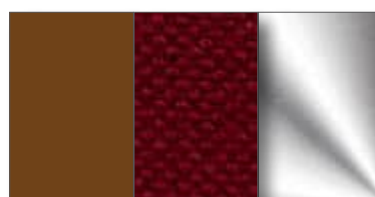

872
MATTONE/BORDEAUX/CROMO
BRICK RED/BURGUNDY/CHROME

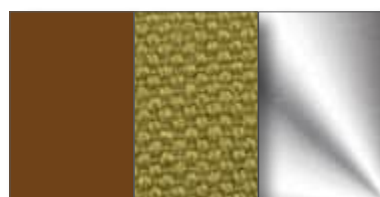

922
MATTONE/VERDE CHIARO/CROMO
BRICK RED/LIGHT GREEN/CHROME

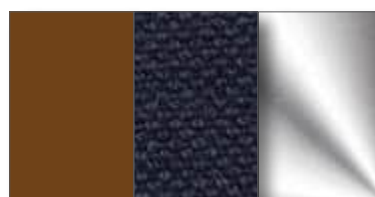

871
MATTONE/BLU/CROMO
BRICK RED/BLUE/CHROME

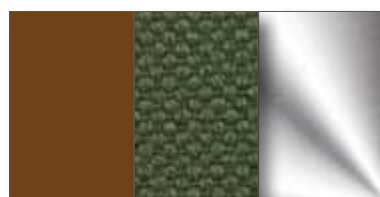

926
MATTONE/VERDE SCURO/CROMO
BRICK RED/DARK GREEN/CHROME

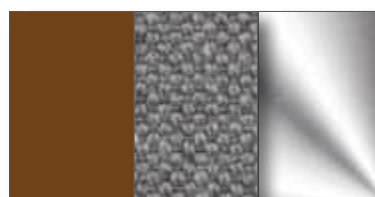

886
MATTONE/GRIGIO CHIARO/CROMO
BRICK RED/LIGHT GREY/CHROME

CAT.A

728 PU RIGIDO VERNICIATO/COTONE BONIFACIO/ACCIAIO CROMATO
STIFF PAINTED PU/COTTON BONIFACIO/CHROMED STEEL

Moon

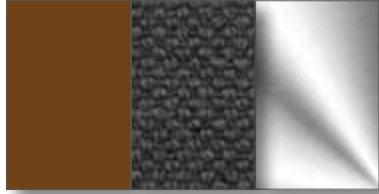

891

MATTONE/GRIGIO SCURO/CROMO
BRICK RED/DARK GREY/CHROME

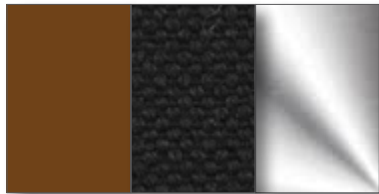

899

MATTONE/NERO/CROMO
BRICK RED/BLACK/CHROME

CAT.A

728 PU RIGIDO VERNICIATO/COTONE BONIFACIO/ACCIAIO CROMATO
STIFF PAINTED PU/COTTON BONIFACIO/CHROMED STEEL

Moon



936
ECRU/BIANCO/CROMO
ECRU/WHITE/CHROME

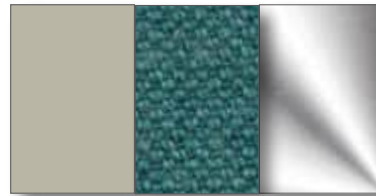

H14
ECRU/VERDE ACQUA/CROMO
ECRU/AQUA GREEN/CHROME

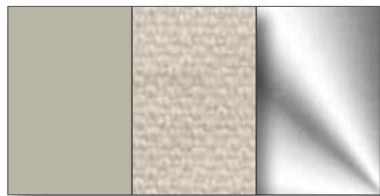

931
ECRU/AVORIO/CROMO
ECRU/IVORY/CHROME

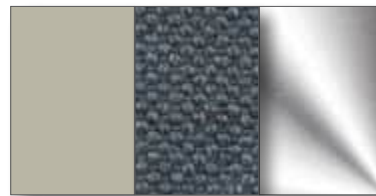

933
ECRU/AZZURRO INDACO/CROMO
ECRU/INDIGO BLUE/CHROME



992
ECRU/TORTORA/CROMO
ECRU/TAUPE/CHROME

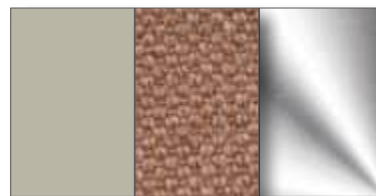

981
ECRU/ROSA/CROMO
ECRU/PINK/CHROME

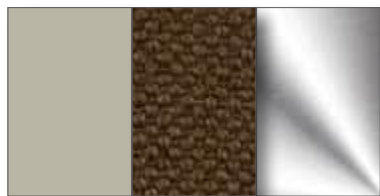

967
ECRU/MARRONE CH./CROMO
ECRU/LIGHT BROWN/CHROME

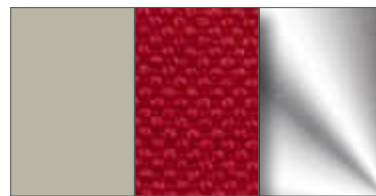

985
ECRU/ROSSO/CROMO
ECRU/RED/CHROME



950
ECRU/OCRA/CROMO
ECRU/OCHRE/CHROME

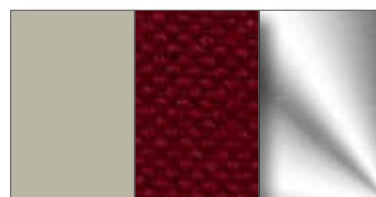

944
ECRU/BORDEAUX/CROMO
ECRU/BURGUNDY/CHROME



994
ECRU/VERDE CHIARO/CROMO
ECRU/LIGHT GREEN/CHROME

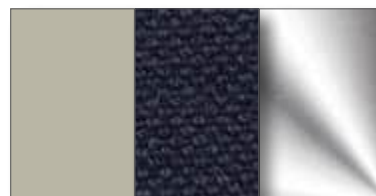

943
ECRU/BLU/CROMO
ECRU/BLUE/CHROME

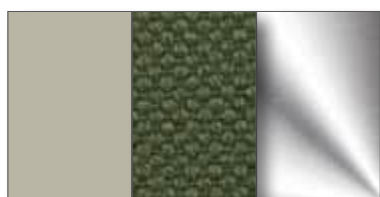

998
ECRU/VERDE SCURO/CROMO
ECRU/DARK GREEN/CHROME

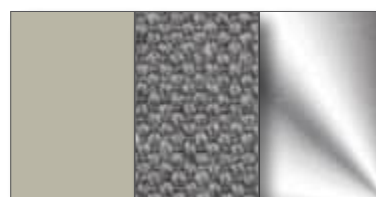

958
ECRU/GRIGIO CHIARO/CROMO
ECRU/LIGHT GREY/CHROME

CAT.A

728 PU RIGIDO VERNICIATO/COTONE BONIFACIO/ACCIAIO CROMATO
STIFF PAINTED PU/COTTON BONIFACIO/CHROMED STEEL

Moon

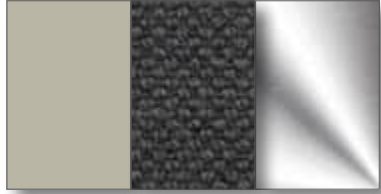

963

ECRU'/GRIGIO SCURO/CROMO
ECRU/DARK GREY/CHROME

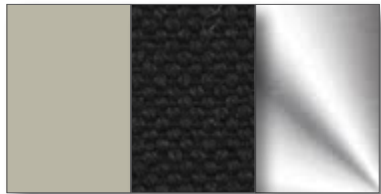

971

ECRU'/NERO/CROMO
ECRU/BLACK/CHROME

CAT.A

728 PU RIGIDO VERNICIATO/COTONE BONIFACIO/ACCIAIO CROMATO
STIFF PAINTED PU/COTTON BONIFACIO/CHROMED STEEL

Moon



A08
NERO/BIANCO/CROMO
BLACK/WHITE/CHROME

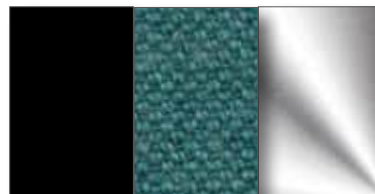

H17
NERO/VERDE ACQUA/CROMO
BLACK/AQUA GREEN/CHROME

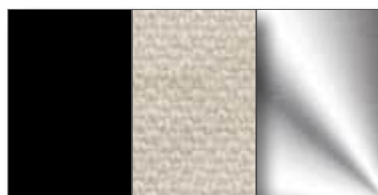

A03
NERO/AVORIO/CROMO
BLACK/IVORY/CHROME



A05
NERO/AZZURRO INDACO/CROMO
BLACK/INDIGO BLUE/CHROME

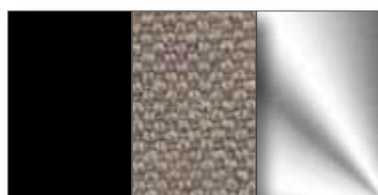

A64
NERO/TORTORA/CROMO
BLACK/TAUPE/CHROME

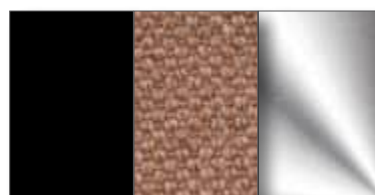

A53
NERO/ROSA/CROMO
BLACK/PINK/CHROME

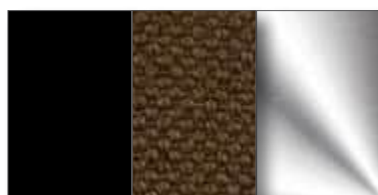

A39
NERO/MARRONE CH./CROMO
BLACK/LIGHT BROWN/CHROME

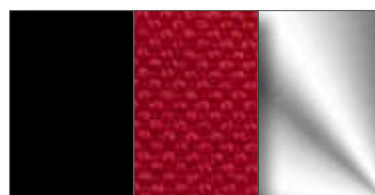

A57
NERO/ROSSO/CROMO
BLACK/RED/CHROME

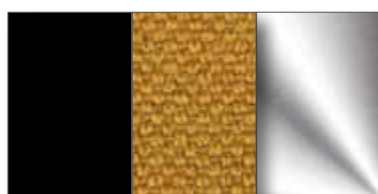

A22
NERO/OCRA/CROMO
BLACK/OCHRE/CHROME

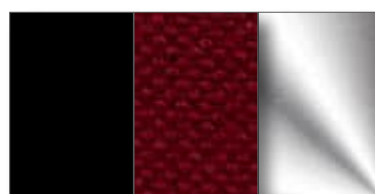

A16
NERO/BORDEAUX/CROMO
BLACK/BURGUNDY/CHROME

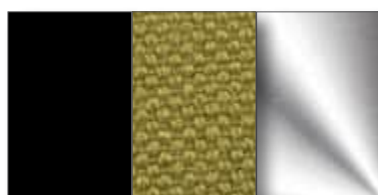

A66
NERO/VERDE CHIARO/CROMO
BLACK/LIGHT GREEN/CHROME

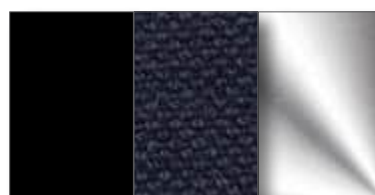

A15
NERO/BLU/CROMO
BLACK/BLUE/CHROME

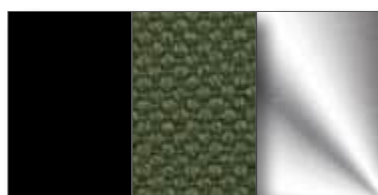

A70
NERO/VERDE SCURO/CROMO
BLACK/DARK GREEN/CHROME

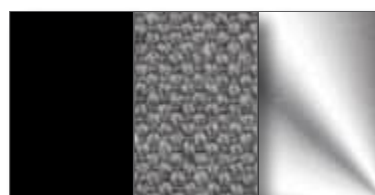

A30
NERO/GRIGIO CHIARO/CROMO
BLACK/LIGHT GREY/CHROME

CAT.A

728 PU RIGIDO VERNICIATO/COTONE BONIFACIO/ACCIAIO CROMATO
STIFF PAINTED PU/COTTON BONIFACIO/CHROMED STEEL

Moon

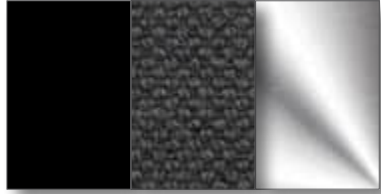

A35

NERO/GRIGIO SCURO/CROMO
BLACK/DARK GREY/CHROME

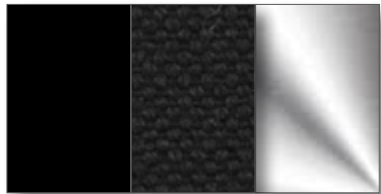

A43

NERO/NERO/CROMO
BLACK/BLACK/CHROME

CAT.A

868 COTONE BONIFACIO/ACCIAIO CROMATO
COTTON BONIFACIO/CHROMED STEEL

Cocky

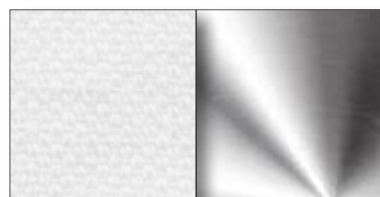

B00
BIANCO/CROMO
WHITE/CHROME

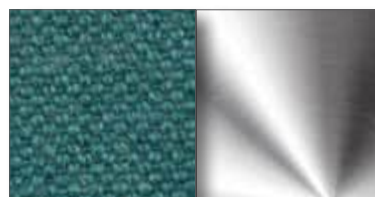

H30
VERDE ACQUA/CROMO
AQUA GREEN/CHROME



C36
AVORIO/CROMO
IVORY/CHROME



H31
AZZURRO INDACO/CROMO
INDIGO BLUE/CHROME



E86
TORTORA/CROMO
TAUPE/CHROME



H27
ROSA/CROMO
PINK/CHROME



C52
MARRONE CH./CROMO
LIGHT BROWN/CHROME



C58
ROSSO/CROMO
RED/CHROME



H28
OCRA/CROMO
OCHRE/CHROME



C41
BORDEAUX/CROMO
BURGUNDY/CHROME



H29
VERDE CHIARO/CROMO
LIGHT GREEN/CHROME



C40
BLU/CROMO
BLUE/CHROME



C63
VERDE SCURO/CROMO
DARK GREEN/CHROME

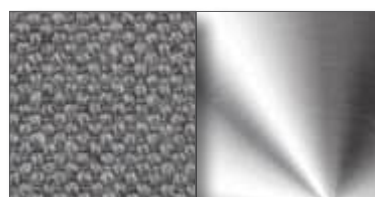

C51
GRIGIO CHIARO/CROMO
LIGHT GREY/CHROME

CAT.A

868 COTONE BONIFACIO/ACCIAIO CROMATO
COTTON BONIFACIO/CHROMED STEEL

Cocky

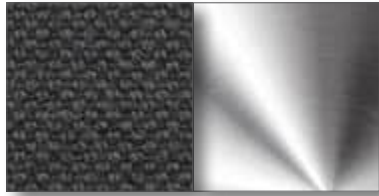

C47
GRIGIO SCURO/CROMO
DARK GREY/CHROME

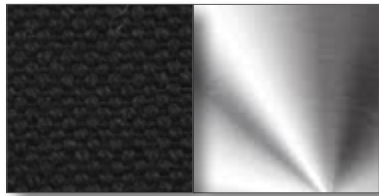

B01
NERO/CROMO
BLACK/CHROME

CAT.A

701 POLIESTERE MARSIGLIA - *POLYESTER MARSIGLIA*

Composizione/Composition: 100% PL. Altezza/Height: 140 cm. Peso/Weight: 840gr. Abrasione/Abrasion: 80.000 Martindale (uso pubblico, uso molto intensivo)/public use, very intensive use. Idrorepellente, irrestringibile/Water repellent, unbreakable.



002
BIANCO
WHITE



004
AVORIO
IVORY



016
TORTORA
TAUPE

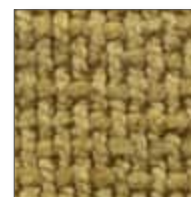

018
GIALLO CHIARO
LIGHT YELLOW



024
ROSA
PINK



063
VERDE
GREEN

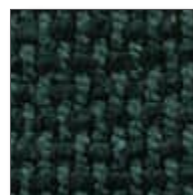

066
VERDE SCURO
DARK GREEN



069
PETROLIO
PETROL GREEN



072
BLU
BLUE

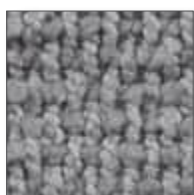

045
GRIGIO CHIARO
LIGHT GREY



050
GRIGIO SCURO
DARK GREY

I colori sono indicativi. Non è possibile garantire uniformità di tono nella tintura dei lotti di tessuto. Resta inteso che lievi differenze di colore verranno accettate al momento dell'ordine.

The colors are just indicative. Actually a steady tone of lots cannot be guaranteed. It remains understood that any slight colour difference will be accepted in case an order is placed.

CAT.A

731 POLIESTERE MARSIGLIA/ACCIAIO VERNICIATO - *POLYESTER MARSIGLIA/PAINTED STEEL*

Sof Sof, 33 Cuscini

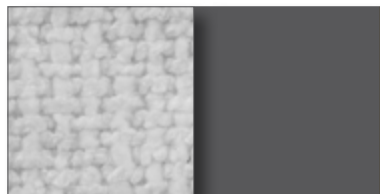

328
BIANCO/GRAFITE
WHITE/GRAPHITE

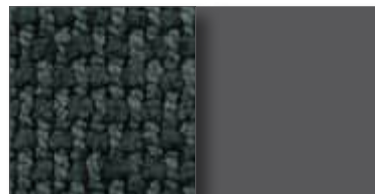

367
PETROLIO/GRAFITE
PETROL GREEN/GRAPHITE



322
AVORIO/GRAFITE
IVORY/GRAPHITE

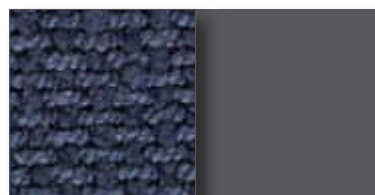

336
BLU/GRAFITE
BLUE/GRAPHITE

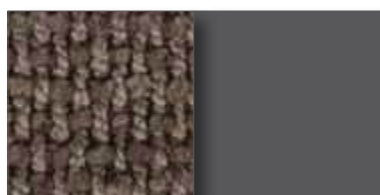

378
TOTRORA/GRAFITE
TAUPE/GRAPHITE

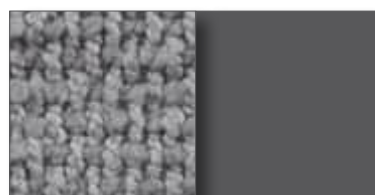

348
GRIGIO CHIARO/GRAFITE
LIGHT GREY/GRAPHITE

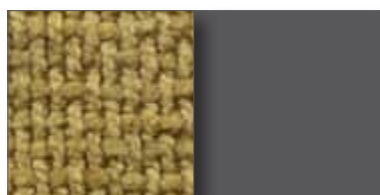

339
GIALLO CHIARO/GRAFITE
LIGHT YELLOW/GRAPHITE

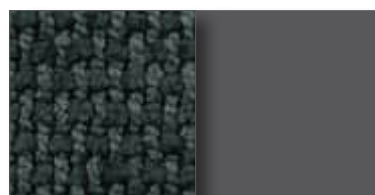

353
GRIGIO SCURO/GRAFITE
DARK GREY/GRAPHITE

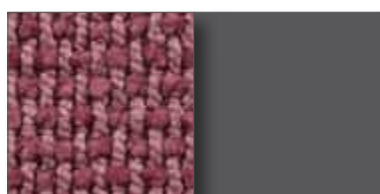

370
ROSA/GRAFITE
PINK/GRAPHITE

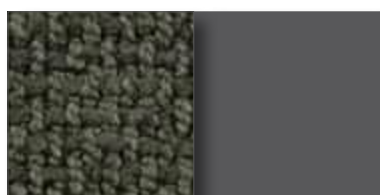

379
VERDE/GRAFITE
GREEN/GRAPHITE

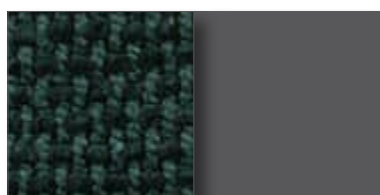

384
VERDE SCURO/GRAFITE
DARK GREEN/GRAPHITE

CAT.A

731 POLIESTERE MARSIGLIA/ACCIAIO VERNICIATO - *POLYESTER MARSIGLIA/PAINTED STEEL*

Elisa

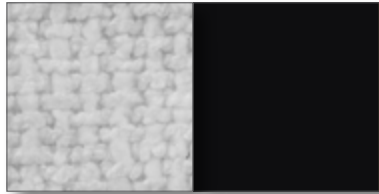

393
BIANCO/NERO MARRONE
WHITE/BLACK BROWN



419
PETROLIO/NERO MARRONE
PETROL GREEN/BLACK BROWN

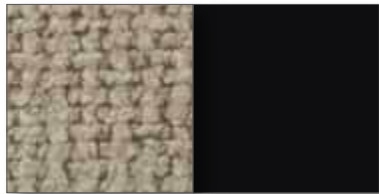

388
AVORIO/NERO MARRONE
IVORY/BLACK BROWN



400
BLU/NERO MARRONE
BLUE/BLACK BROWN



427
TORTORA/NERO MARRONE
TAUPE/BLACK BROWN

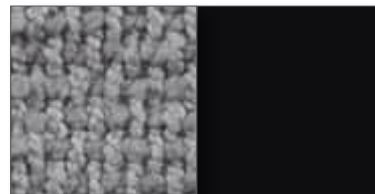

407
GRIGIO CHIARO/NERO MARRONE
LIGHT GREY/BLACK BROWN

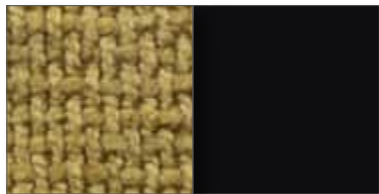

402
GIALLO CHIARO/NERO MARRONE
LIGHT YELLOW/BLACK BROWN

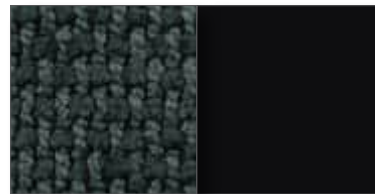

411
GRIGIO SCURO/NERO MARRONE
DARK GREY/BLACK BROWN

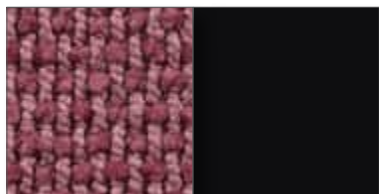

422
ROSA/NERO MARRONE
PINK/BLACK BROWN

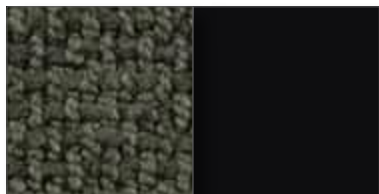

428
VERDE/NERO MARRONE
GREEN/BLACK BROWN

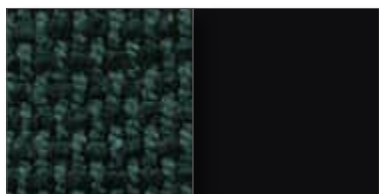

432
VERDE SCURO/NERO MARRONE
DARK GREEN/BLACK BROWN

CAT.A

731 POLIESTERE MARSIGLIA/ACCIAIO VERNICIATO - POLYESTER MARSIGLIA/PAINTED STEEL

Fenix



442
BIANCO/PELTRO BRONZATO
WHITE/BRONZE PEWTER



486
PETROLIO/PELTRO BRONZATO
PETROL GREEN/BRONZE PEWTER

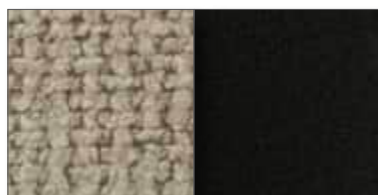

436
AVORIO/PELTRO BRONZATO
IVORY/BRONZE PEWTER



450
BLU/PELTRO BRONZATO
BLUE/BRONZE PEWTER



501
TORTORA/PELTRO BRONZATO
TAUPE/BRONZE PEWTER

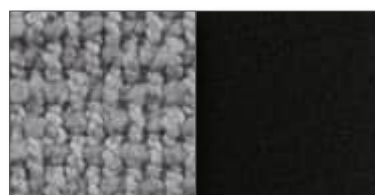

466
GRIGIO CHIARO/PELTRO BRONZATO
LIGHT GREY/BRONZE PEWTER

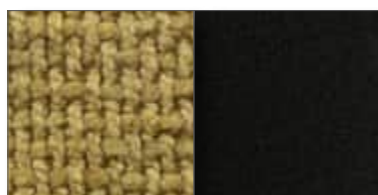

457
GIALLO CHIARO/PELTRO BRONZATO
LIGHT YELLOW/BRONZE PEWTER



471
GRIGIO SCURO/PELTRO BRONZATO
DARK GREY/BRONZE PEWTER

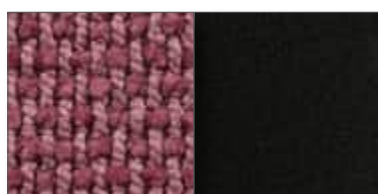

490
ROSA/PELTRO BRONZATO
PINK/BRONZE PEWTER

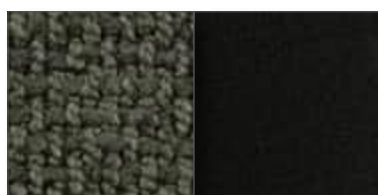

502
VERDE/PELTRO BRONZATO
GREEN/BRONZE PEWTER



507
VERDE SCURO/PELTRO BRONZATO
DARK GREEN/BRONZE PEWTER

CAT.A

731 POLIESTERE MARSIGLIA/ACCIAIO VERNICIATO - *POLYESTER MARSIGLIA/PAINTED STEEL*

Cocky



596
BIANCO/NERO
WHITE/BLACK



639
PETROLIO/NERO
PETROL GREEN/BLACK

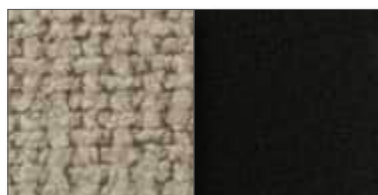

590
AVORIO/NERO
IVORY/BLACK



604
BLU/NERO
BLUE/BLACK



655
TORTORA/NERO
TAUPE/BLACK

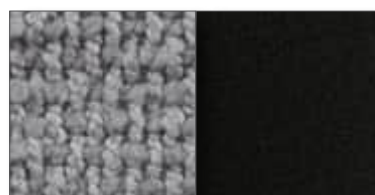

620
GRIGIO CHIARO/NERO
LIGHT GREY/BLACK

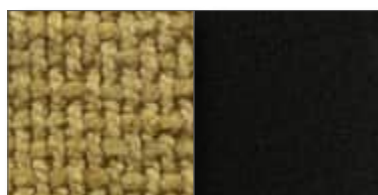

611
GIALLO CHIARO/NERO
LIGHT YELLOW/BLACK



625
GRIGIO SCURO/NERO
DARK GREY/BLACK

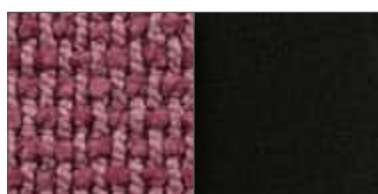

643
ROSA/NERO
PINK/BLACK

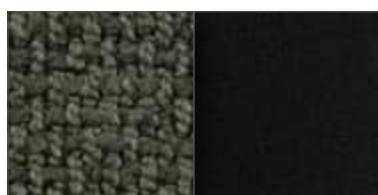

656
VERDE/NERO
GREEN/BLACK



661
VERDE SCURO/NERO
DARK GREEN/BLACK

CAT.A

732 POLIESTERE MARSIGLIA/ALLUMINIO LUCIDATO - *POLYESTER MARSIGLIA/POLISHED ALUMINUM*

Cocky

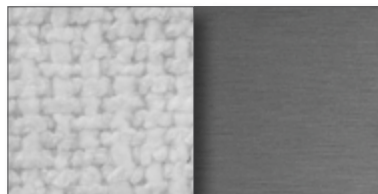

531
BIANCO/ALLUMINIO
WHITE/ALUMINUM

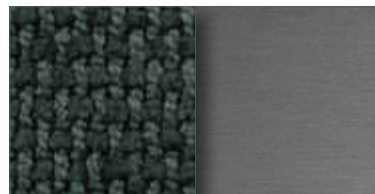

568
PETROLIO/ALLUMINIO
PETROL GREEN/ALUMINUM

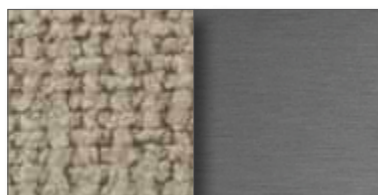

526
AVORIO/ALLUMINIO
IVORY/ALUMINUM

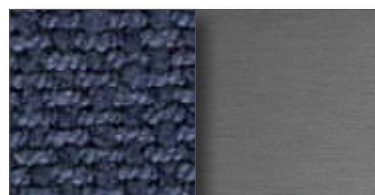

536
BLU/ALLUMINIO
BLUE/ALUMINUM

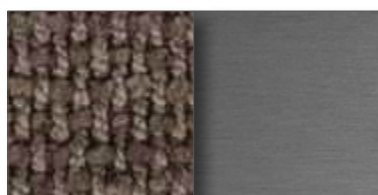

582
TORTORA/ALLUMINIO
TAUPE/ALUMINUM

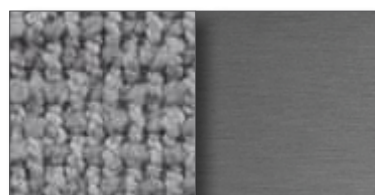

550
GRIGIO CHIARO/ALLUMINIO
LIGHT GREY/ALUMINUM

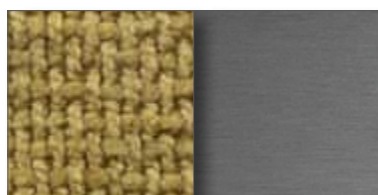

542
GIALLO CHIARO/ALLUMINIO
LIGHT YELLOW/ALUMINUM

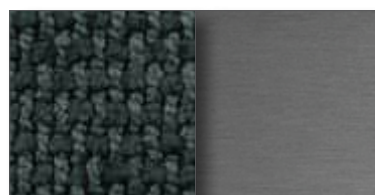

554
GRIGIO SCURO/ALLUMINIO
DARK GREY/ALUMINUM

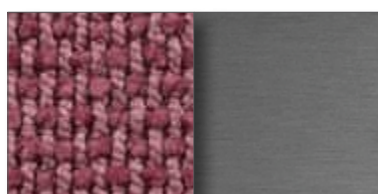

572
ROSA/ALLUMINIO
PINK/ALUMINUM

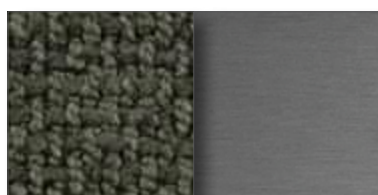

583
VERDE/ALLUMINIO
GREEN/ALUMINUM

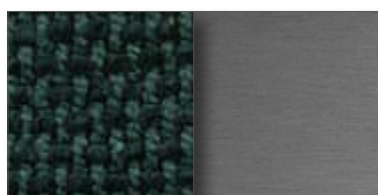

585
VERDE SCURO/ALLUMINIO
DARK GREEN/ALUMINUM

CAT.A

733 POLIESTERE MARSIGLIA/ALLUMINIO VERNICIATO - *POLYESTER MARSIGLIA/PAINTED ALUMINUM*

Lirica, Lirico

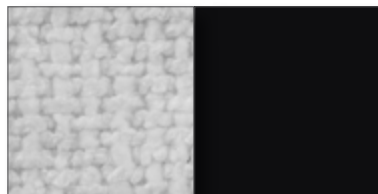

596
BIANCO/NERO
WHITE/BLACK

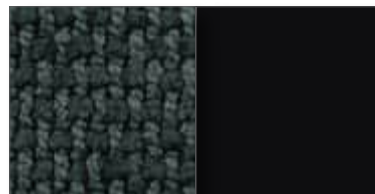

639
PETROLIO/NERO
PETROL GREEN/BLACK

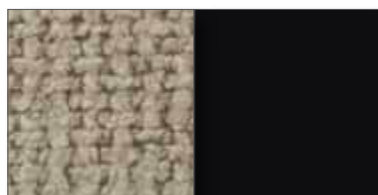

590
AVORIO/NERO
IVORY/BLACK

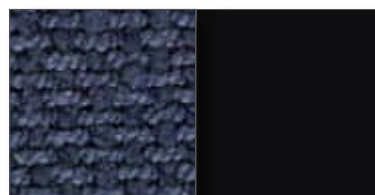

604
BLU/NERO
BLUE/BLACK

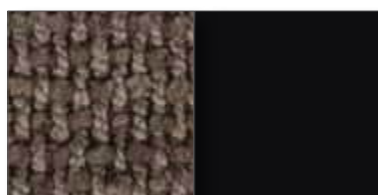

655
TORTORA/NERO
TAUPE/BLACK

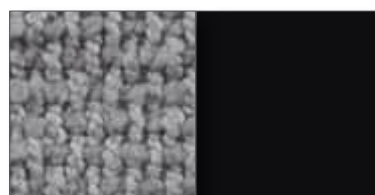

620
GRIGIO CHIARO/NERO
LIGHT GREY/BLACK

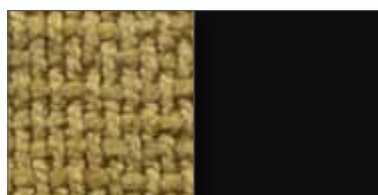

611
GIALLO CHIARO/NERO
LIGHT YELLOW/BLACK

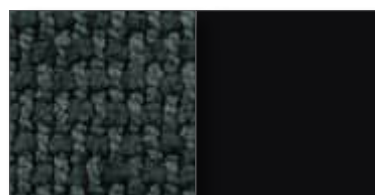

625
GRIGIO SCURO/NERO
DARK GREY/BLACK

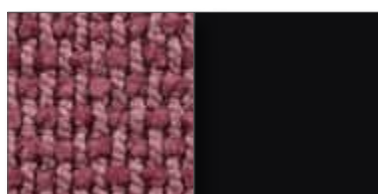

643
ROSA/NERO
PINK/BLACK

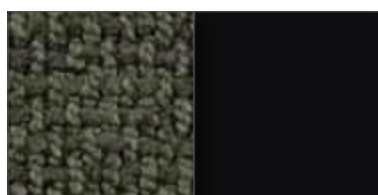

656
VERDE/NERO
GREEN/BLACK

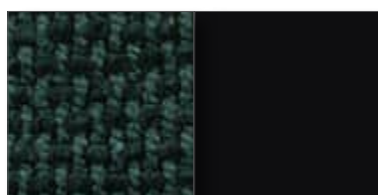

661
VERDE SCURO/NERO
DARK GREEN/BLACK

CAT.A

733 POLIESTERE MARSIGLIA/ALLUMINIO VERNICIATO - *POLYESTER MARSIGLIA/PAINTED ALUMINUM*

Lirica, Lirico



722
BIANCO/ARGENTO
WHITE/SILVER



766
PETROLIO/ARGENTO
PETROL GREEN/SILVER



716
AVORIO/ARGENTO
IVORY/SILVER



730
BLU/ARGENTO
BLUE/SILVER



782
TORTORA/ARGENTO
TAUPE/SILVER

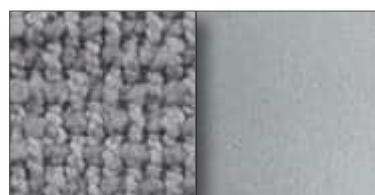

746
GRIGIO CHIARO/NERO
LIGHT GREY/BLACK

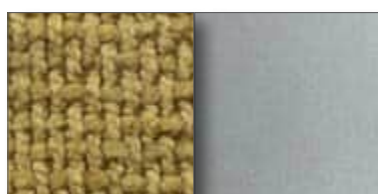

737
GIALLO CHIARO/ARGENTO
LIGHT YELLOW/SILVER



751
GRIGIO SCURO/NERO
DARK GREY/BLACK

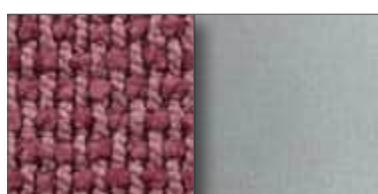

770
ROSA/ARGENTO
PINK/SILVER



783
VERDE/ARGENTO
GREEN/SILVER



788
VERDE SCURO/ARGENTO
DARK GREEN/SILVER

CAT.A

733 POLIESTERE MARSIGLIA/FAGGIO LACCATO - *POLYESTER MARSIGLIA/LACQUERED BEECH*

S.Marco, S.Marco Lounge



596
BIANCO/NERO
WHITE/BLACK



639
PETROLIO/NERO
PETROL GREEN/BLACK



590
AVORIO/NERO
IVORY/BLACK

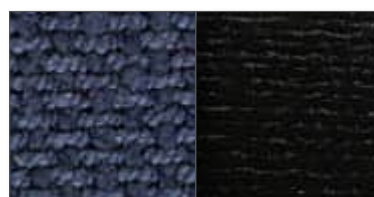

604
BLU/NERO
BLUE/BLACK



655
TORTORA/NERO
TAUPE/BLACK

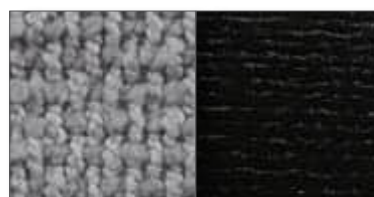

620
GRIGIO CHIARO/NERO
LIGHT GREY/BLACK

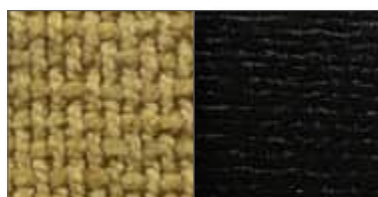

611
GIALLO CHIARO/NERO
LIGHT YELLOW/BLACK



625
GRIGIO SCURO/NERO
DARK GREY/BLACK

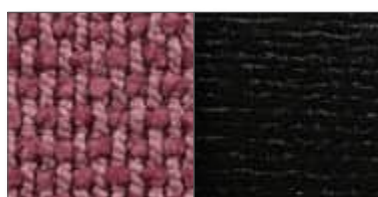

643
ROSA/NERO
ROSA/BLACK



656
VERDE/NERO
GREEN/BLACK



661
VERDE SCURO/NERO
DARK GREEN/BLACK

CAT.A

737 PU RIGIDO VERNICIATO/POLIESTERE MARSIGLIA/ACCIAIO CROMATO
STIFF PAINTED PU/POLYESTER MARSIGLIA/CHROMED STEEL

Moon

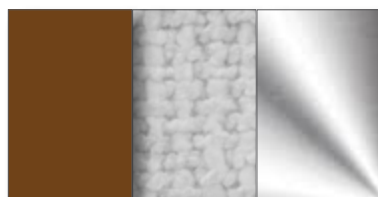

864
MATTONE/BIANCO/CROMO
RED BRICK/WHITE/CHROME

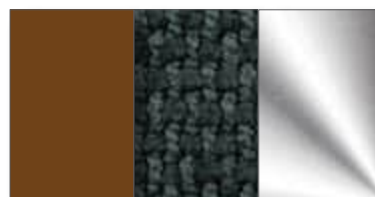

905
MATTONE/PETROLIO/CROMO
RED BRICK/PETROL GREEN/CHROME

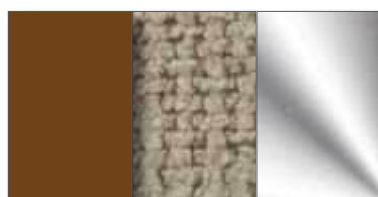

859
MATTONE/AVORIO/CROMO
RED BRICK/IVORY/CHROME

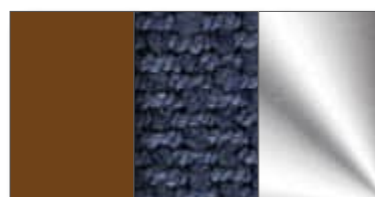

871
MATTONE/BLU/CROMO
RED BRICK/BLUE/CHROME

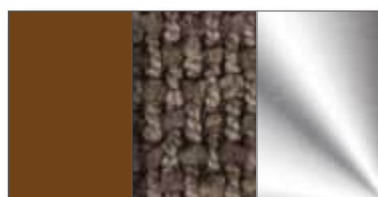

920
MATTONE/TORTORA/CROMO
RED BRICK/TAUPE/CHROME

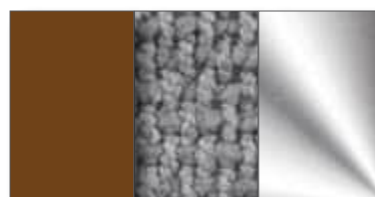

886
MATTONE/GRIGIO CHIARO/CROMO
RED BRICK/LIGHT GREY/CHROME

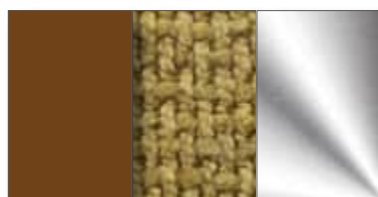

877
MATTONE/GIALLO CHIARO/CROMO
RED BRICK/LIGHT YELLOW/CHROME

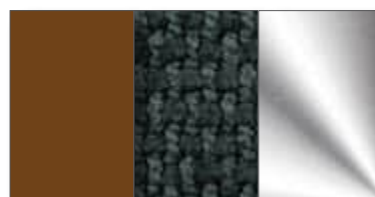

891
MATTONE/GRIGIO SCURO/CROMO
RED BRICK/DARK GREY/CHROME

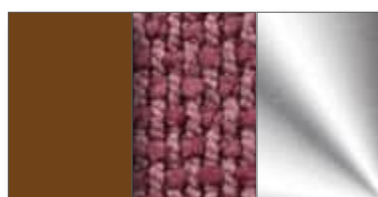

909
MATTONE/ROSA/CROMO
RED BRICK/PINK/CHROME

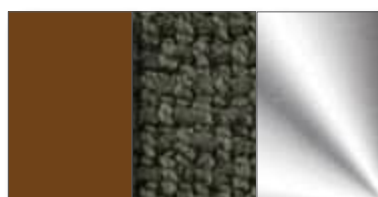

921
MATTONE/VERDE/CROMO
RED BRICK/GREEN/CHROME

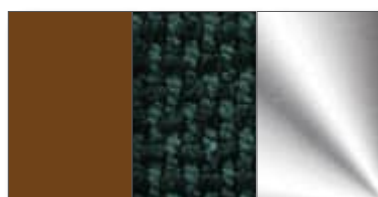

926
MATTONE/VERDE SCURO/CROMO
RED BRICK/DARK GREEN/CHROME

CAT.A

737 PU RIGIDO VERNICIATO/POLIESTERE MARSIGLIA/ACCIAIO CROMATO
STIFF PAINTED PU/POLYESTER MARSIGLIA/CHROMED STEEL

Moon

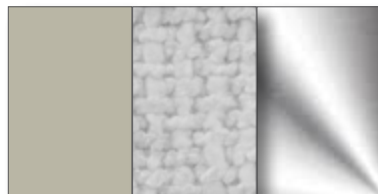

936
ECRU/BIANCO/CROMO
ECRU/WHITE/CHROME

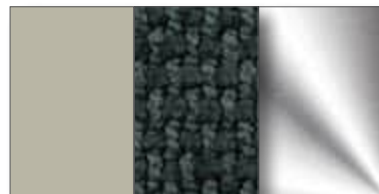

977
ECRU/PETROLIO/CROMO
ECRU/PETROL GREEN/CHROME

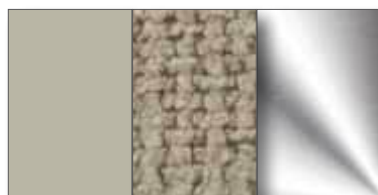

931
ECRU/AVORIO/CROMO
ECRU/IVORY/CHROME

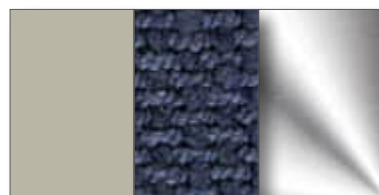

943
ECRU/BLU/CROMO
ECRU/BLUE/CHROME

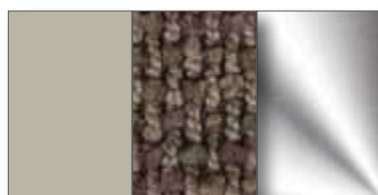

992
ECRU/TORTORA/CROMO
ECRU/TAUPE/CHROME

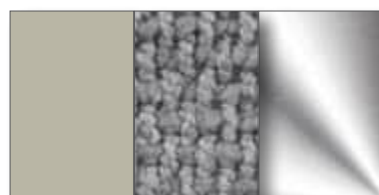

958
ECRU/GRIGIO CHIARO/CROMO
ECRU/LIGHT GREY/CHROME



946
ECRU/GIALLO CHIARO/CROMO
ECRU/LIGHT YELLOW/CHROME

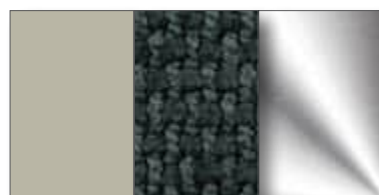

963
ECRU/GRIGIO SCURO/CROMO
ECRU/DARK GREY/CHROME

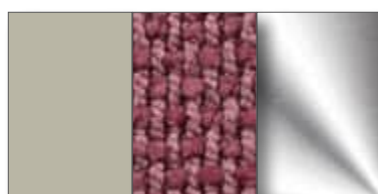

981
ECRU/ROSA/CROMO
ECRU/PINK/CHROME

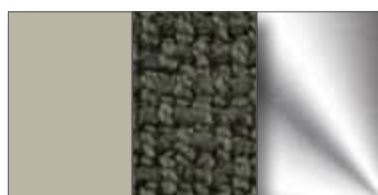

993
ECRU/VERDE/CROMO
ECRU/GREEN/CHROME

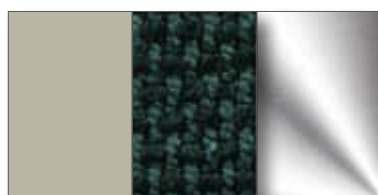

998
ECRU/VERDE SCURO/CROMO
ECRU/DARK GREEN/CHROME

CAT.A

737 PU RIGIDO VERNICIATO/POLIESTERE MARSIGLIA/ACCIAIO CROMATO
STIFF PAINTED PU/POLYESTER MARSIGLIA/CHROMED STEEL

Moon

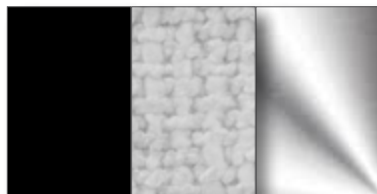

A08
NERO/BIANCO/CROMO
BLACK/WHITE/CHROME



A49
NERO/PETROLIO/CROMO
BLACK/PETROL GREEN/CHROME

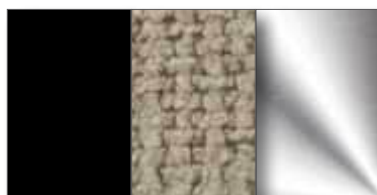

A03
NERO/AVORIO/CROMO
BLACK/IVORY/CHROME

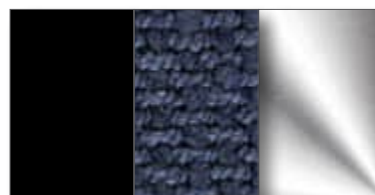

A15
NERO/BLU/CROMO
BLACK/BLUE/CHROME

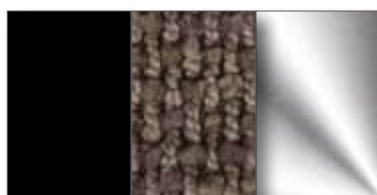

A64
NERO/TORTORA/CROMO
BLACK/TAUPE/CHROME

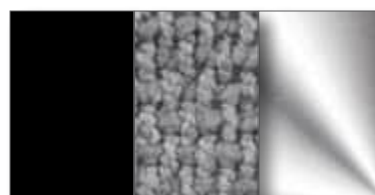

A30
NERO/GRIGIO CHIARO/CROMO
BLACK/LIGHT GREY/CHROME

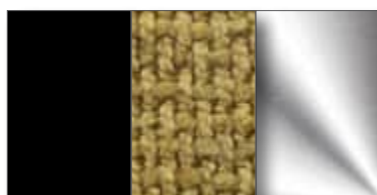

A21
NERO/GIALLO CHIARO/CROMO
BLACK/LIGHT YELLOW/CHROME



A35
NERO/GRIGIO SCURO/CROMO
BLACK/DARK GREY/CHROME

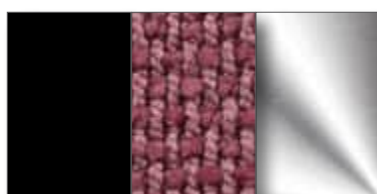

A53
NERO/ROSA/CROMO
BLACK/PINK/CHROME

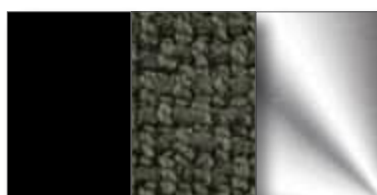

A65
NERO/VERDE/CROMO
BLACK/GREEN/CHROME

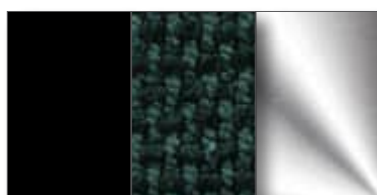

A70
NERO/VERDE SCURO/CROMO
BLACK/DARK GREEN/CHROME

CAT.A

869 POLIESTERE MARSIGLIA/ACCIAIO CROMATO
 POLYESTER MARSIGLIA/CHROMED STEEL

Cocky

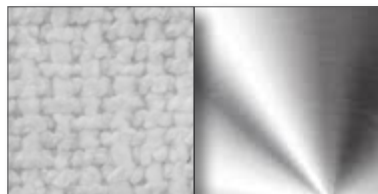

B00
 BIANCO/CROMO
 WHITE/CHROME



C56
 PETROLIO/CROMO
 PETROL GREEN/CHROME



C36
 AVORIO/CROMO
 IVORY/CHROME



C40
 BLU/CROMO
 BLUE/CHROME



E86
 TORTORA/CROMO
 TAUPE/CHROME

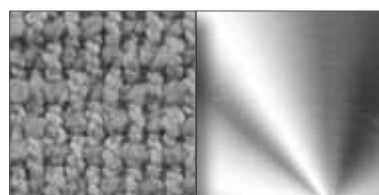

C51
 GRIGIO CHIARO/CROMO
 LIGHT GREY/CHROME

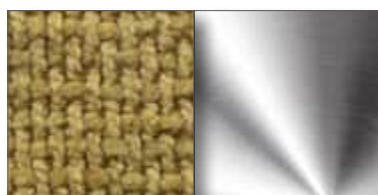

H25
 GIALLO CHIARO/CROMO
 LIGHT YELLOW/CHROME

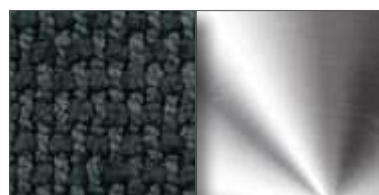

C47
 GRIGIO SCURO/CROMO
 DARK GREY/CHROME

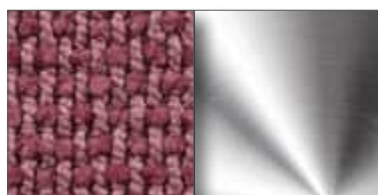

H27
 ROSA/CROMO
 PINK/CHROME



H26
 VERDE/CROMO
 GREEN/CHROME

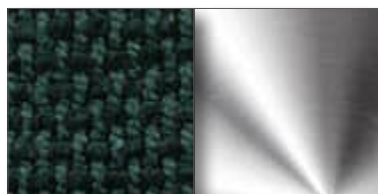

C63
 VERDE SCURO/CROMO
 DARK GREEN/CHROME

CAT.A

702 MISTO COTONE PETRA - COTTON MIX PETRA

Composizione/Composition: 50% CO riciclato/recycled CO, 35% PL, 15% PC. Altezza/Height: 140 cm. Peso/Weight: 490gr. Abrasione/Abrasion: 20.000 Martindale (uso pubblico, uso regolare/public use, regular use). Antigoccia, idrorepellente/Anti-drip, water repellent.

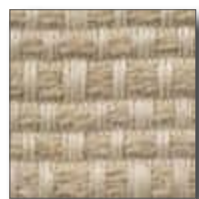

002
BIANCO
WHITE



011
SABBIA
SAND

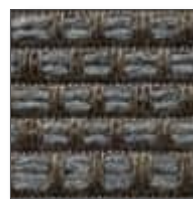

016
TORTORA
TAUPE



H18
ORO
GOLD

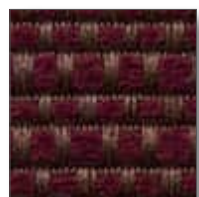

040
BORDEAUX
BURGUNDY

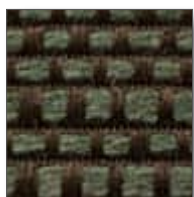

063
VERDE
GREEN



085
TESTA DI MORO
DARK BROWN



072
BLU
BLUE

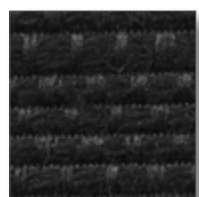

091
NERO
BLACK

I colori sono indicativi. Non è possibile garantire uniformità di tono nella tintura dei lotti di tessuto. Resta inteso che lievi differenze di colore verranno accettate al momento dell'ordine.

The colors are just indicative. Actually a steady tone of lots cannot be guaranteed. It remains understood that any slight colour difference will be accepted in case an order is placed.

CAT.A

738 MISTO COTONE PETRA/FRASSINO - COTTON MIX PETRA/ASH

La Francesea

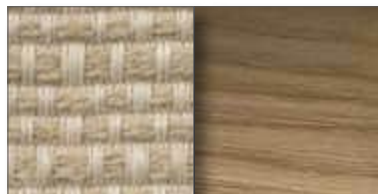

177
BIANCO/NATURALE
WHITE/NATURAL

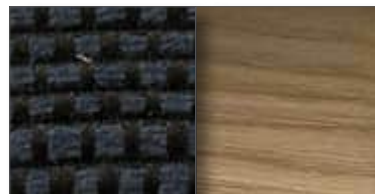

182
BLU/NATURALE
BLEU/NATURAL



221
SABBIA/NATURALE
SAND/NATURAL

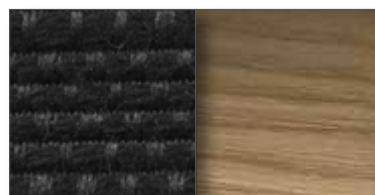

207
NERO/NATURALE
BLACK/NATURAL

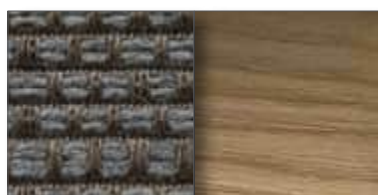

224
TORTORA/NATURALE
TAUPE/NATURAL

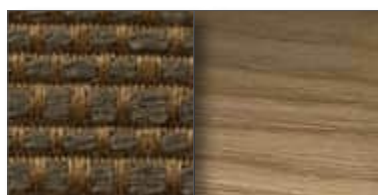

H32
ORO/NATURALE
GOLD/NATURAL

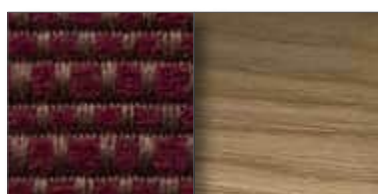

183
BORDEAUX/NATURALE
BURGUNDY/NATURAL

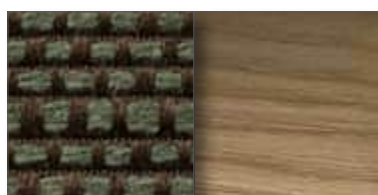

225
VERDE/NATURALE
GREEN/NATURAL

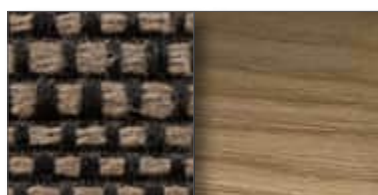

223
TESTA DI MORO/NATURALE
DARK BROWN/NATURAL

CAT.A

738 MISTO COTONE PETRA/FRASSINO - COTTON MIX PETRA/ASH

La Francesea



230
BIANCO/EBANIZZATO
WHITE/EBONIZED

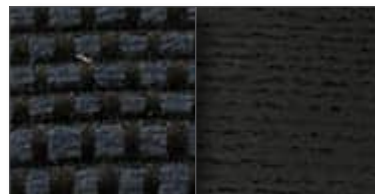

242
BLU/EBANIZZATO
BLUE/EBONIZED



282
SABBIA/EBANIZZATO
SAND/EBONIZED

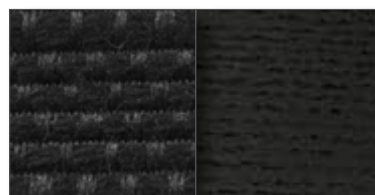

267
NERO/EBANIZZATO
BLACK/EBONIZED

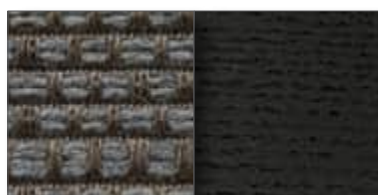

286
TORTORA/EBANIZZATO
TAUPE/EBONIZED

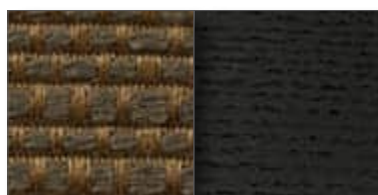

H33
ORO/EBANIZZATO
GOLD/EBONIZED

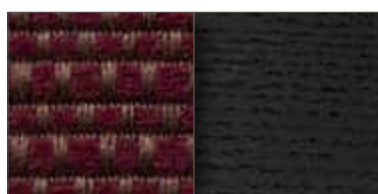

243
BORDEAUX/EBANIZZATO
BURGUNDY/EBONIZED



287
VERDE/EBANIZZATO
GREEN/EBONIZED

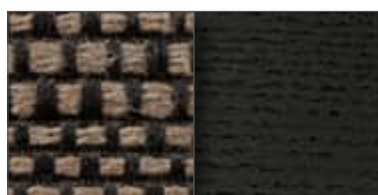

285
TESTA DI MORO/EBANIZZATO
DARK BROWN/EBONIZED

CAT.A

740 MISTO COTONE PETRA/ACCIAIO VERNICIATO - COTTON MIX PETRA/PAINTED STEEL

Sof Sof, 33 Cuscini

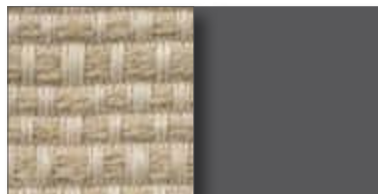

328
BIANCO/GRAFITE
WHITE|GRAPHITE

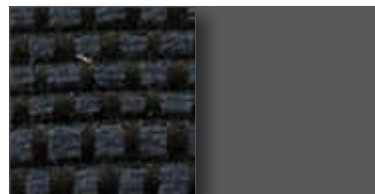

336
BLU/GRAFITE
BLUE|GRAPHITE

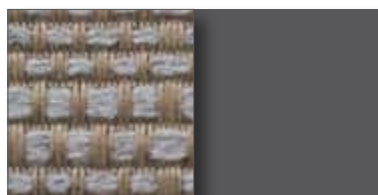

377
SABBIA/GRAFITE
SAND|GRAPHITE

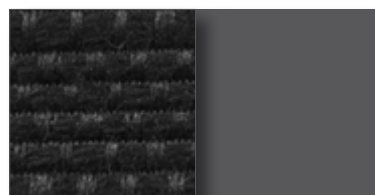

361
NERO/GRAFITE
BLACK|GRAPHITE

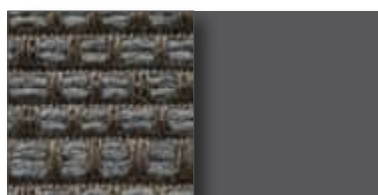

378
TORTORA/GRAFITE
TAUPE|GRAPHITE

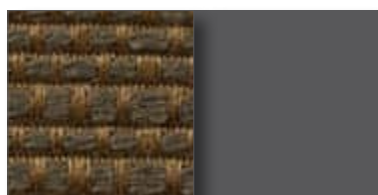

H35
ORO/GRAFITE
GOLD|GRAPHITE

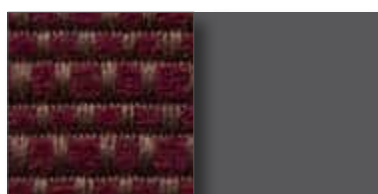

337
BORDEAUX/GRAFITE
BORDEAUX|GRAPHITE

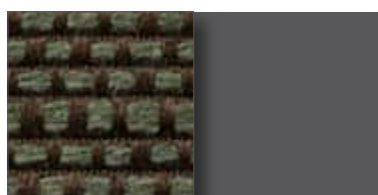

379
VERDE/GRAFITE
GREEN|GRAPHITE

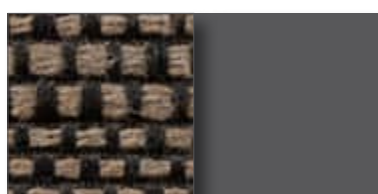

H34
TESTA DI MORO/GRAFITE
DARK BROWN|GRAPHITE

CAT.A

740 MISTO COTONE PETRA/ACCIAIO VERNICIATO - COTTON MIX PETRA/PAINTED STEEL

Elisa

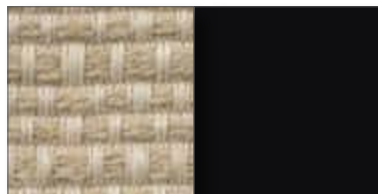

393
BIANCO/NERO MARRONE
WHITE/BLACK BROWN

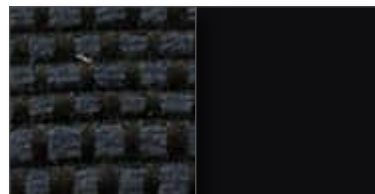

400
BLU/NERO MARRONE
BLUE/BLACK BROWN

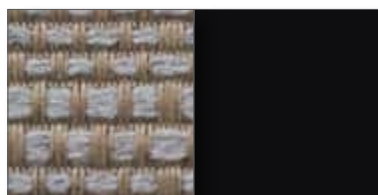

426
SABBIA/NERO MARRONE
SAND/BLACK BROWN

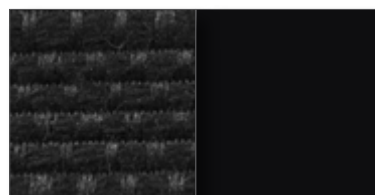

417
NERO/NERO MARRONE
BLACK/BLACK BROWN

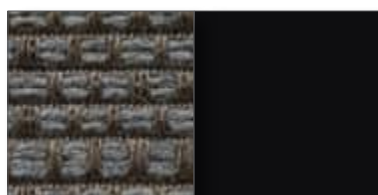

427
TORTORA/NERO MARRONE
TAUPE/BLACK BROWN

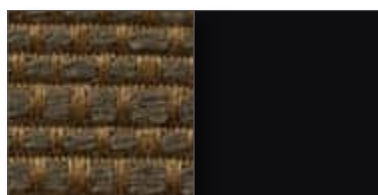

H36
ORO/NERO MARRONE
GOLD/BLACK BROWN

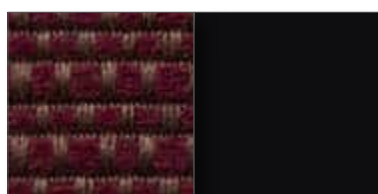

401
BORDEAUX/NERO MARRONE
BORDEAUX/BLACK BROWN

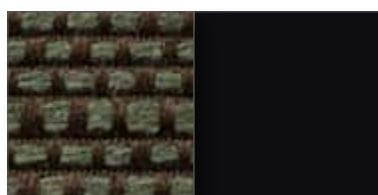

428
VERDE/NERO MARRONE
GREEN/BLACK BROWN

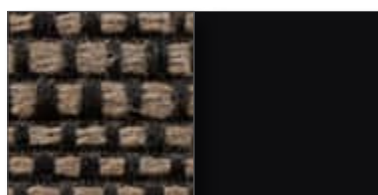

G58
TESTA DI MORO/NERO MARRONE
DARK BROWN/BLACK BROWN

CAT.A

740 MISTO COTONE PETRA/ACCIAIO VERNICIATO - COTTON MIX PETRA/PAINTED STEEL

Fenix

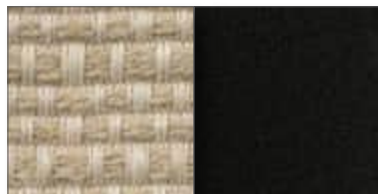

442
BIANCO/PELTRO BRONZATO
WHITE|BRONZE PEWTER

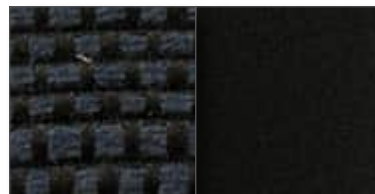

450
BLU/PELTRO BRONZATO
BLU|BRONZE PEWTER

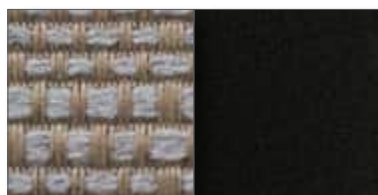

498
SABBIA/PELTRO BRONZATO
SAND|BRONZE PEWTER

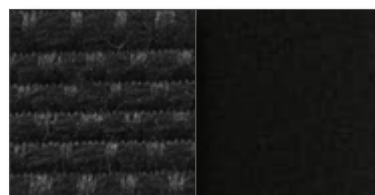

479
NERO/PELTRO BRONZATO
BLACK|BRONZE PEWTER

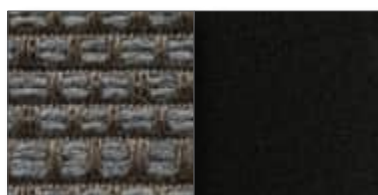

501
TORTORA/PELTRO BRONZATO
TAUPE|BRONZE PEWTER

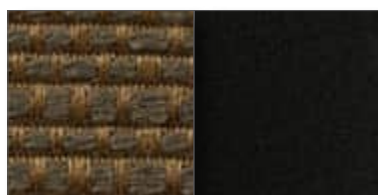

H37
ORO/PELTRO BRONZATO
GOLD|BRONZE PEWTER

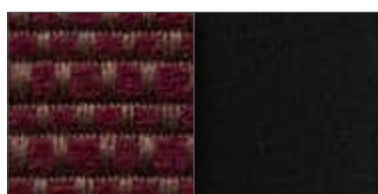

451
BORDEAUX/PELTRO BRONZATO
BURGUNDY|BRONZE PEWTER



502
VERDE/PELTRO BRONZATO
GREEN|BRONZE PEWTER

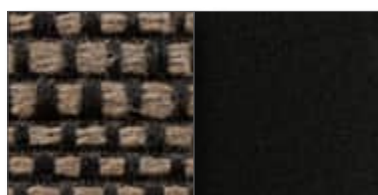

500
TESTA DI MORO/PELTRO BRONZATO
DARK BROWN|BRONZE PEWTER

CAT.A

740 MISTO COTONE PETRA/ACCIAIO VERNICIATO - COTTON MIX PETRA/PAINTED STEEL

Cocky

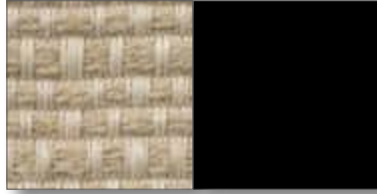

596
BIANCO/NERO
WHITE/BLACK

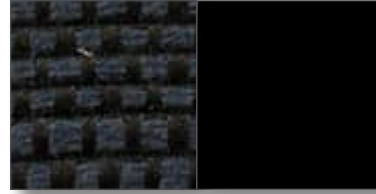

604
BLU/NERO
BLU/BLACK



651
SABBIA/NERO
SAND/BLACK

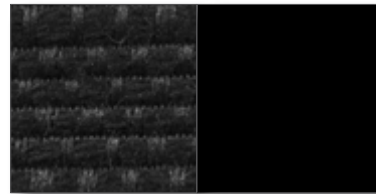

632
NERO/NERO
BLACK/BLACK



655
TORTORA/NERO
TAUPE/BLACK

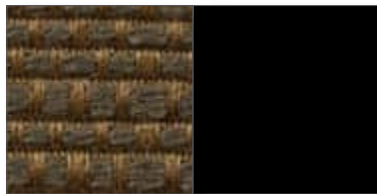

H40
ORO/NERO
GOLD/BLACK

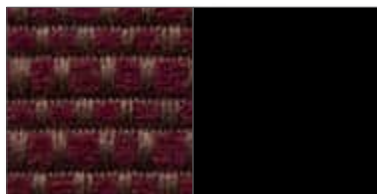

605
BORDEAUX/NERO
BURGUNDY/BLACK

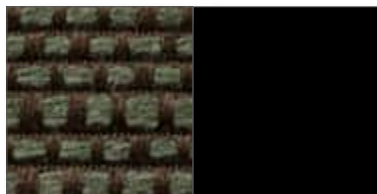

656
VERDE/NERO
GREEN/BLACK

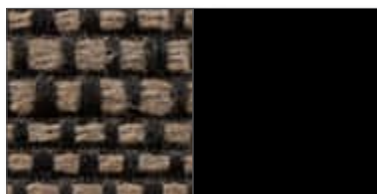

654
TESTA DI MORO/NERO
DARK BROWN/BLACK

CAT.A

741 MISTO COTONE PETRA/ALLUMINIO LUCIDATO - COTTON MIX PETRA/POLISHED ALUMINUM

Lou Speak, Cocky

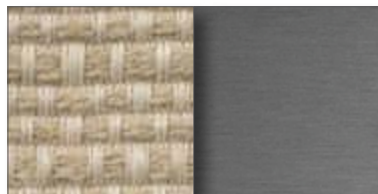

531
BIANCO/ALLUMINIO
WHITE/ALUMINUM

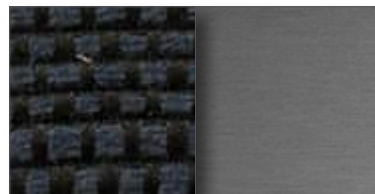

536
BLU/ALLUMINIO
BLUE/ALUMINUM

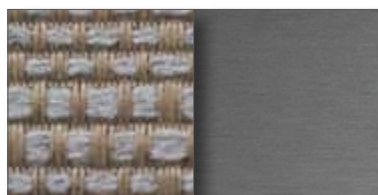

578
SABBIA/ALLUMINIO
SAND/ALUMINUM

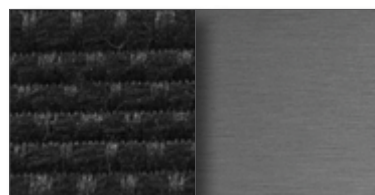

561
NERO/ALLUMINIO
BLACK/ALUMINUM

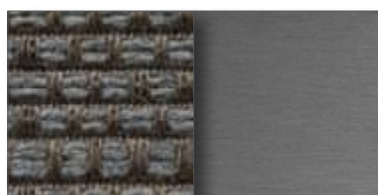

582
TORTORA/ALLUMINIO
TAUPE/ALUMINUM

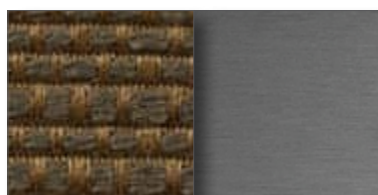

H41
ORO/ALLUMINIO
GOLD/ALUMINUM

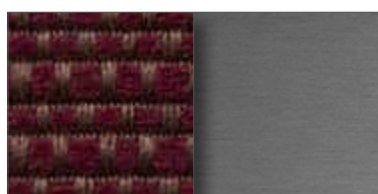

537
BORDEAUX/ALLUMINIO
BURGUNDY/ALUMINUM

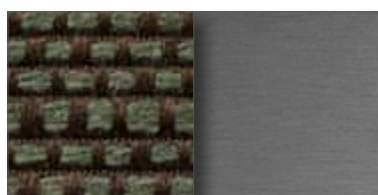

583
VERDE/ALLUMINIO
GREEN/ALUMINUM

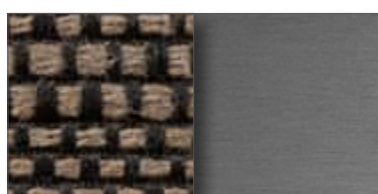

581
TESTA DI MORO/ALLUMINIO
DARK BROWN/ALUMINUM

CAT.A

742 MISTO COTONE PETRA/ALLUMINIO VERNICIATO - COTTON MIX PETRA/PAINTED ALUMINUM

Lirica, Lirico

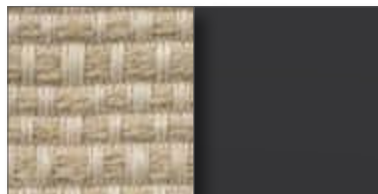

596
BIANCO/NERO
WHITE/BLACK

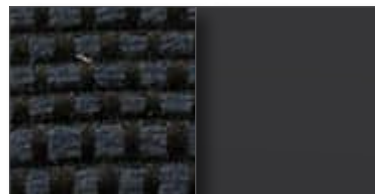

604
BLU/NERO
BLUE/BLACK

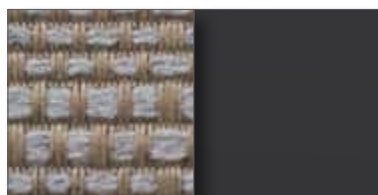

651
SABBIA/NERO
SAND/BLACK

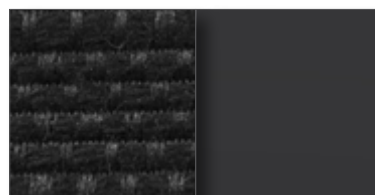

632
NERO/NERO
BLACK/BLACK

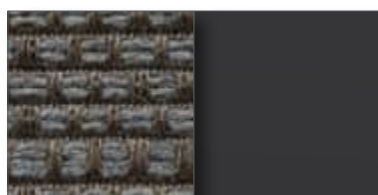

655
TORTORA/NERO
TAUPE/BLACK

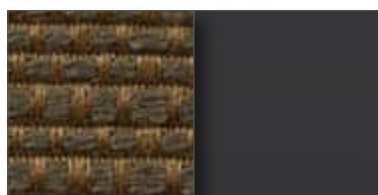

H40
ORO/NERO
GOLD/BLACK

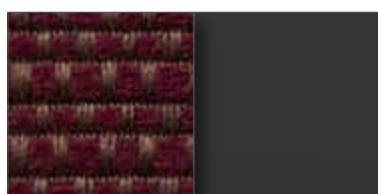

605
BORDEAUX/NERO
BURGUNDY/BLACK

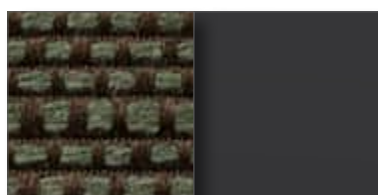

656
VERDE/NERO
GREEN/BLACK

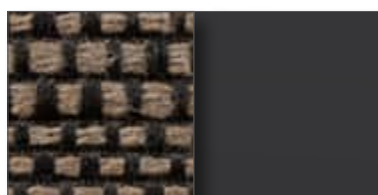

654
TESTA DI MORO/NERO
DARK BROWN/BLACK

CAT.A

742 MISTO COTONE PETRA/ALLUMINIO VERNICIATO - COTTON MIX PETRA/PAINTED ALUMINUM

Lirica, Lirico



722
BIANCO/ARGENTO
WHITE/SILVER



730
BLU/ARGENTO
BLUE/SILVER



778
SABBIA/ARGENTO
SAND/SILVER



759
NERO/ARGENTO
BLACK/SILVER



782
TORTORA/ARGENTO
TAUPE/SILVER



H42
ORO/ARGENTO
GOLD/SILVER



731
BORDEAUX/ARGENTO
BURGUNDY/SILVER



783
VERDE/ARGENTO
GREEN/SILVER

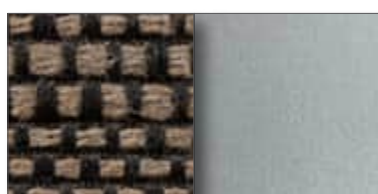

781
TESTA DI MORO/ARGENTO
DARK BROWN/SILVER

CAT.A

745 MISTO COTONE PETRA/FAGGIO LACCATO - COTTON MIX PETRA/LACQUERED BEECH

S.Marco, S.Marco Lounge



596
BIANCO/NERO
WHITE/BLACK



604
BLU/NERO
BLUE/BLACK



651
SABBIA/NERO
SAND/BLACK

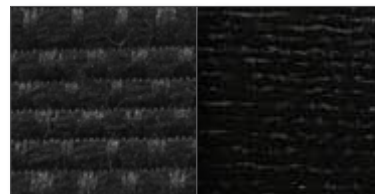

632
NERO/NERO
BLACK/BLACK



655
TORTORA/NERO
TAUPE/BLACK

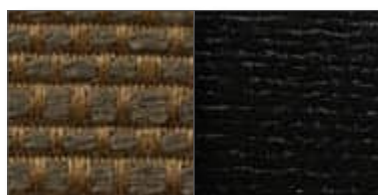

H40
ORO/NERO
GOLD/BLACK

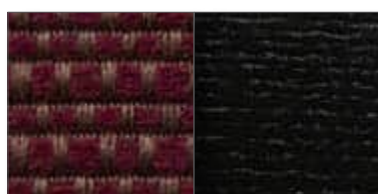

605
BORDEAUX/NERO
BURGUNDY/BLACK



656
VERDE/NERO
GREEN/BLACK

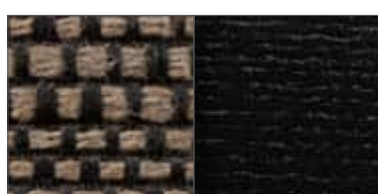

654
TESTA DI MORO/NERO
DARK BROWN/BLACK

CAT.A

746 PU RIGIDO VERNICIATO/MISTO COTONE PETRA/ACCIAIO CROMATO
 STIFF PAINTED PU/COTTON MIX PETRA/CHROMED STEEL

Moon

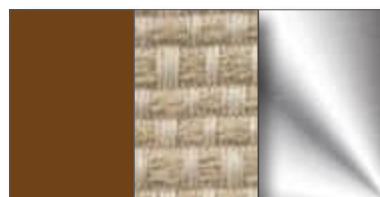

864
 MATTONE/BIANCO/CROMO
 BRICK RED/WHITE/CHROME

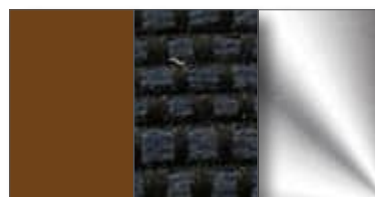

871
 MATTONE/BLU/CROMO
 BRICK RED/BLUE/CHROME

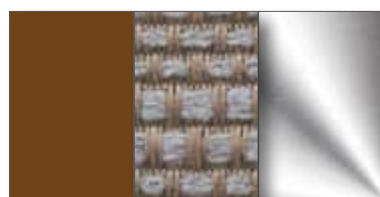

917
 MATTONE/SABBIA/CROMO
 BRICK RED/SAND/CHROME

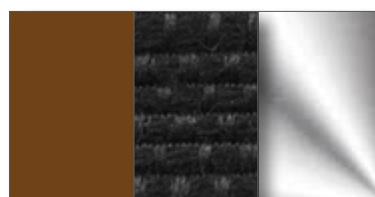

899
 MATTONE/NERO/CROMO
 BRICK RED/BLACK/CHROME

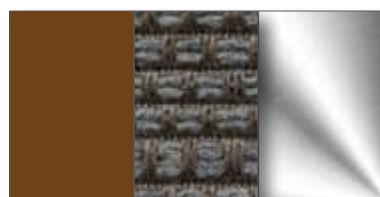

920
 MATTONE/TORTORA/CROMO
 BRICK RED/TAUPE/CHROME

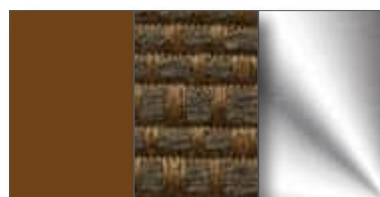

H43
 MATTONE/ORO/CROMO
 BRICK RED/ORO/CHROME

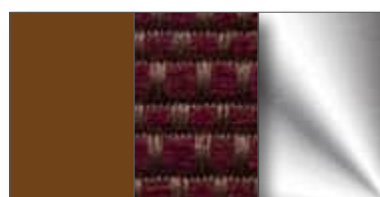

872
 MATTONE/BORDEAUX/CROMO
 BRICK RED/BURGUNDY/CHROME

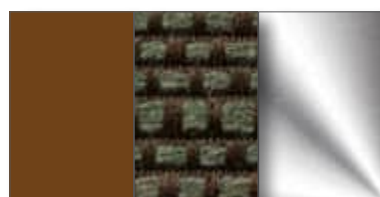

921
 MATTONE/VERDE/CROMO
 BRICK RED/GREEN/CHROME

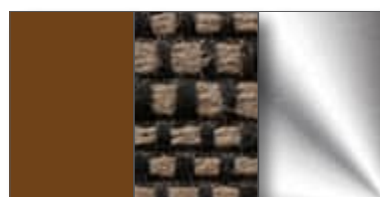

919
 MATTONE/TESTA DI MORO/CROMO
 BRICK RED/DARK BROWN/CHROME

CAT.A

746 PU RIGIDO VERNICIATO/MISTO COTONE PETRA/ACCIAIO CROMATO
 STIFF PAINTED PU/COTTON MIX PETRA/CHROMED STEEL

Moon

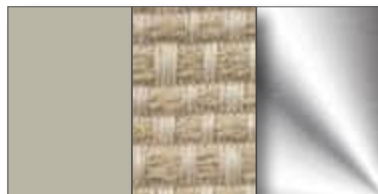

936
 ECRU/BIANCO/CROMO
 ECRU/WHITE/CHROME

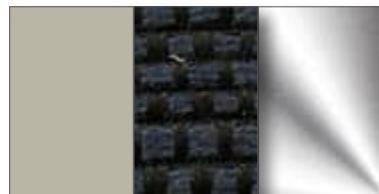

943
 ECRU/BLU/CROMO
 ECRU/BLUE/CHROME

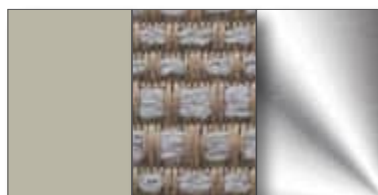

989
 ECRU/SABBIA/CROMO
 ECRU/SAND/CHROME

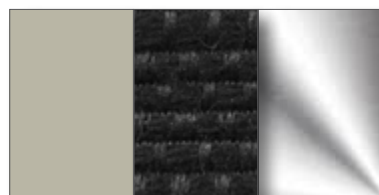

971
 ECRU/NERO/CROMO
 ECRU/BLACK/CHROME

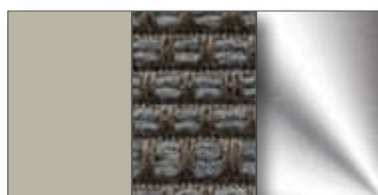

992
 ECRU/TORTORA/CROMO
 ECRU/TAUPE/CHROME

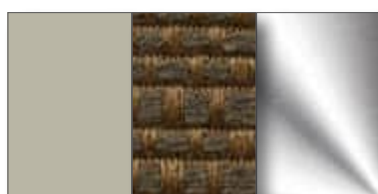

H44
 ECRU/ORO/CROMO
 ECRU/ORO/CHROME

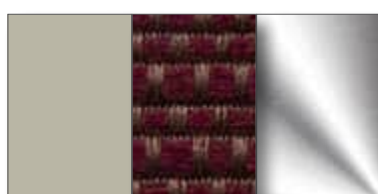

944
 ECRU/BORDEAUX/CROMO
 ECRU/BURGUNDY/CHROME

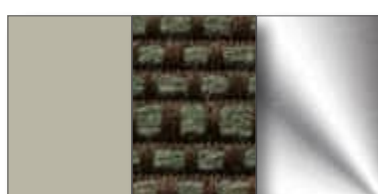

993
 ECRU/VERDE/CROMO
 ECRU/GREEN/CHROME

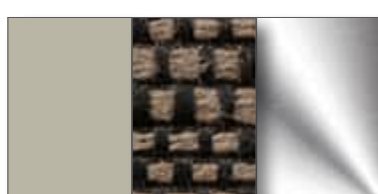

991
 ECRU/TESTA DI MORO/CROMO
 ECRU/DARK BROWN/CHROME

CAT.A

746 PU RIGIDO VERNICIATO/MISTO COTONE PETRA/ACCIAIO CROMATO
 STIFF PAINTED PU/COTTON MIX PETRA/CHROMED STEEL

Moon

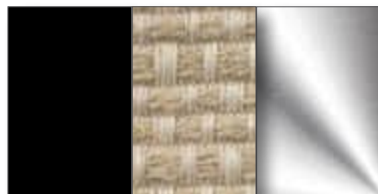

A08
 NERO/BIANCO/CROMO
 BLACK/WHITE/CHROME

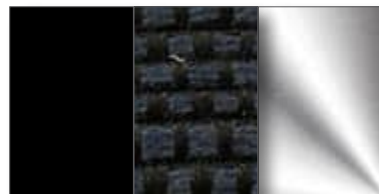

A15
 NERO/BLU/CROMO
 BLACK/BLUE/CHROME

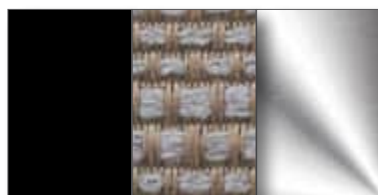

A61
 NERO/SABBIA/CROMO
 BLACK/SAND/CHROME

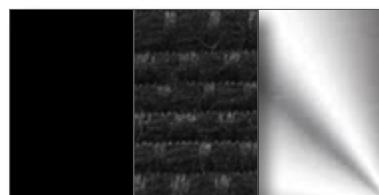

A43
 NERO/NERO/CROMO
 BLACK/BLACK/CHROME

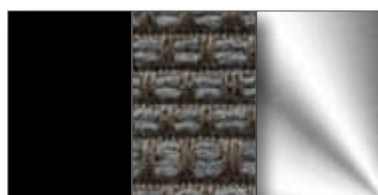

A64
 NERO/TORTORA/CROMO
 BLACK/TAUPE/CHROME

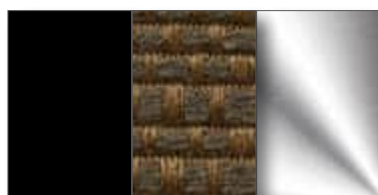

H45
 NERO/ORO/CROMO
 BLACK/GOLD/CHROME

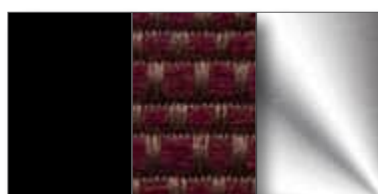

A16
 NERO/BORDEAUX/CROMO
 BLACK/BURGUNDY/CHROME

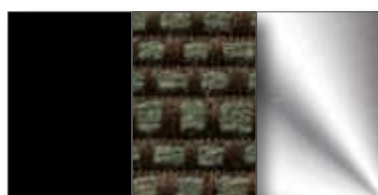

A65
 NERO/VERDE/CROMO
 BLACK/GREEN/CHROME

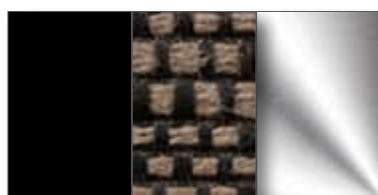

A63
 NERO/TESTA DI MORO/CROMO
 BLACK/DARK BROWN/CHROME

CAT.A

870 MISTO COTONE PETRA/ACCIAIO CROMATO
COTTON MIX PETRA/CHROMED STEEL

Cocky



B00
BIANCO/CROMO
WHITE/CHROME



C40
BLU/CROMO
BLUE/CHROME



C59
SABBIA/CROMO
SAND/CHROME

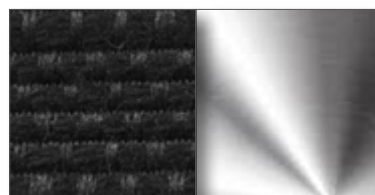

B01
NERO/CROMO
BLACK/CHROME



E86
TORTORA/CROMO
TAUPE/CHROME



H46
ORO/CROMO
GOLD/CHROME



C41
BORDEAUX/CROMO
BURGUNDY/CHROME

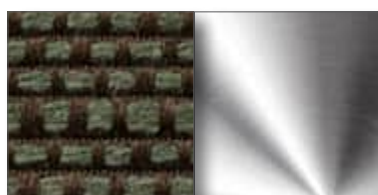

H26
VERDE/CROMO
GREEN/CHROME

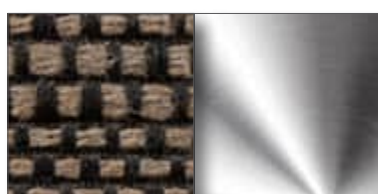

C62
TESTA DI MORO/CROMO
DARK BROWN/CHROME

CAT.A

703 MISTO COTONE DAMASCO - COTTON MIX DAMASCO

Composizione/Composition: 50% CO riciclato/recycled CO, 35% PL, 15% PC. Altezza/Height: 140 cm. Peso/Weight: 590gr. Abrasione/Abrasion: 24.000 Martindale (uso pubblico, uso regolare/public use, regular use). Antigoccia, idrorepellente/Anti-drip, water repellent.

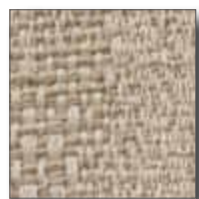

002
BIANCO
WHITE



011
SABBIA
SAND

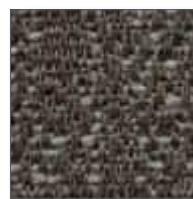

016
TORTORA
TAUPE



H18
ORO
GOLD

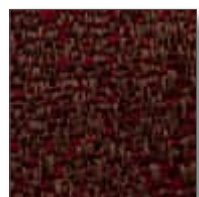

040
BORDEAUX
BURGUNDY



063
VERDE
GREEN

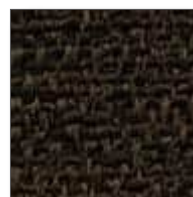

085
TESTA DI MORO
DARK BROWN



072
BLU
BLUE



091
NERO
BLACK

I colori sono indicativi. Non è possibile garantire uniformità di tono nella tintura dei lotti di tessuto. Resta inteso che lievi differenze di colore verranno accettate al momento dell'ordine.

The colors are just indicative. Actually a steady tone of lots cannot be guaranteed. It remains understood that any slight colour difference will be accepted in case an order is placed.

CAT.A

747 MISTO COTONE DAMASCO/FRASSINO - COTTON MIX DAMASCO/ASH

La Francesea



177
BIANCO/NATURALE
WHITE/NATURAL

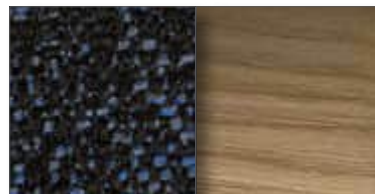

182
BLU/NATURALE
BLEU/NATURAL

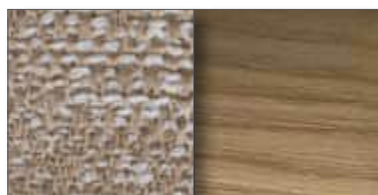

221
SABBIA/NATURALE
SAND/NATURAL

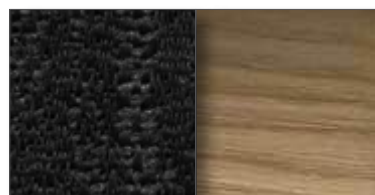

207
NERO/NATURALE
BLACK/NATURAL



224
TORTORA/NATURALE
TAUPE/NATURAL

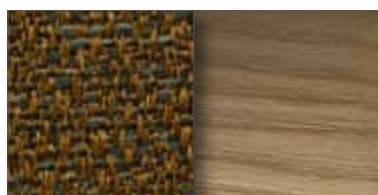

H32
ORO/NATURALE
GOLD/NATURAL

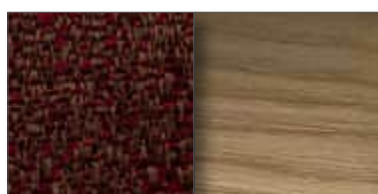

183
BORDEAUX/NATURALE
BURGUNDY/NATURAL

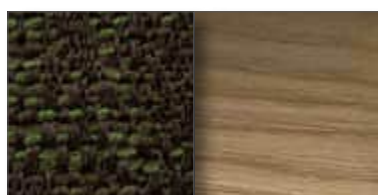

225
VERDE/NATURALE
GREEN/NATURAL



223
TESTA DI MORO/NATURALE
DARK BROWN/NATURAL

CAT.A

747 MISTO COTONE DAMASCO/FRASSINO - COTTON MIX DAMASCO/ASH

La Francesea



230
BIANCO/EBANIZZATO
WHITE/EBONIZED

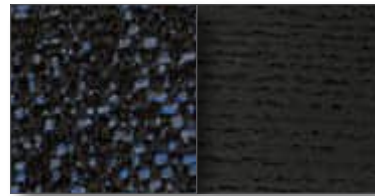

242
BLU/EBANIZZATO
BLUE/EBONIZED

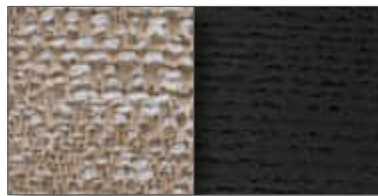

282
SABBIA/EBANIZZATO
SAND/EBONIZED

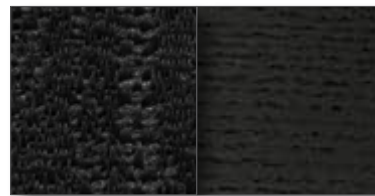

267
NERO/EBANIZZATO
BLACK/EBONIZED



286
TORTORA/EBANIZZATO
TAUPE/EBONIZED

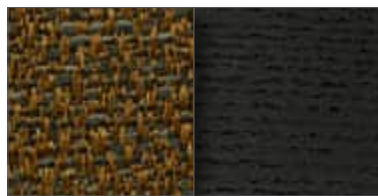

H33
ORO/EBANIZZATO
GOLD/EBONIZED



243
BORDEAUX/EBANIZZATO
BURGUNDY/EBONIZED



287
VERDE/EBANIZZATO
GREEN/EBONIZED



285
TESTA DI MORO/EBANIZZATO
DARK BROWN/EBONIZED

CAT.A

749 MISTO COTONE DAMASCO/ACCIAIO VERNICIATO - COTTON MIX DAMASCO/PAINTED STEEL

Sof Sof, 33 Cuscini



328
BIANCO/GRAFITE
WHITE/GRAPHITE

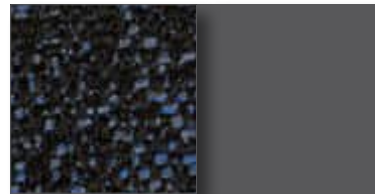

336
BLU/GRAFITE
BLUE/GRAPHITE

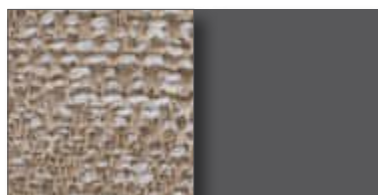

377
SABBIA/GRAFITE
SAND/GRAPHITE

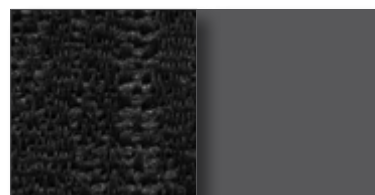

361
NERO/GRAFITE
BLACK/GRAPHITE

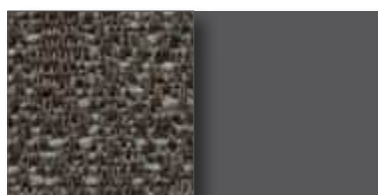

378
TORTORA/GRAFITE
TAUPE/GRAPHITE

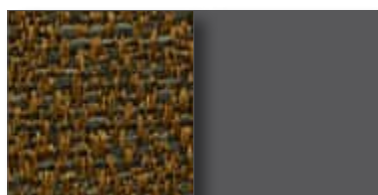

H35
ORO/GRAFITE
GOLD/GRAPHITE

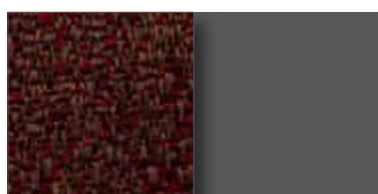

337
BORDEAUX/GRAFITE
BORDEAUX/GRAPHITE

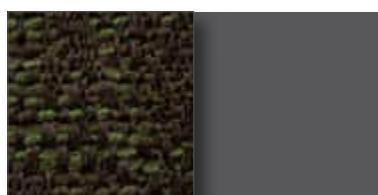

379
VERDE/GRAFITE
GREEN/GRAPHITE

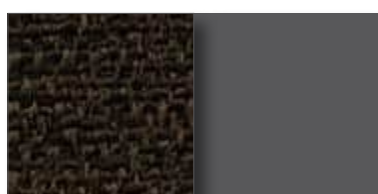

H34
TESTA DI MORO/GRAFITE
DARK BROWN/GRAPHITE

CAT.A

749 MISTO COTONE DAMASCO/ACCIAIO VERNICIATO - COTTON MIX DAMASCO/PAINTED STEEL

Elisa

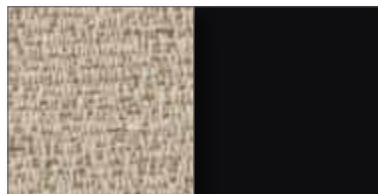

393
BIANCO/NERO MARRONE
WHITE/BLACK BROWN

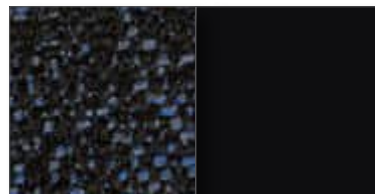

400
BLU/NERO MARRONE
BLUE/BLACK BROWN

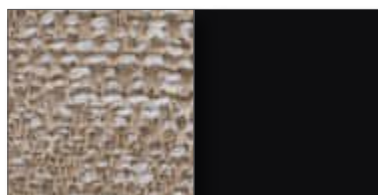

426
SABBIA/NERO MARRONE
SAND/BLACK BROWN

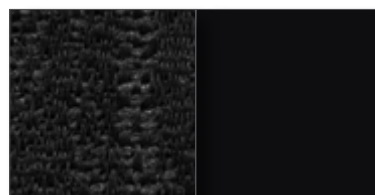

417
NERO/NERO MARRONE
BLACK/BLACK BROWN

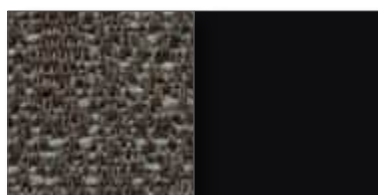

427
TORTORA/NERO MARRONE
TAUPE/BLACK BROWN

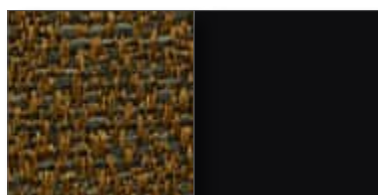

H36
ORO/NERO MARRONE
GOLD/BLACK BROWN

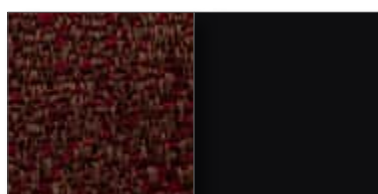

401
BORDEAUX/NERO MARRONE
BORDEAUX/BLACK BROWN

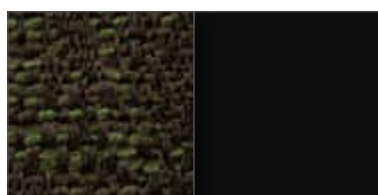

428
VERDE/NERO MARRONE
GREEN/BLACK BROWN

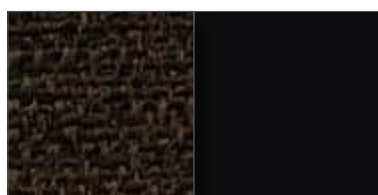

G58
TESTA DI MORO/NERO MARRONE
DARK BROWN/BLACK BROWN

CAT.A

749 MISTO COTONE DAMASCO/ACCIAIO VERNICIATO - COTTON MIX DAMASCO/PAINTED STEEL

Fenix

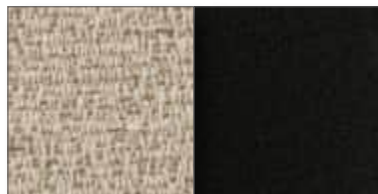

442
BIANCO/PELTRO BRONZATO
WHITE|BRONZE PEWTER



450
BLU/PELTRO BRONZATO
BLU|BRONZE PEWTER



498
SABBIA/PELTRO BRONZATO
SAND|BRONZE PEWTER



479
NERO/PELTRO BRONZATO
BLACK|BRONZE PEWTER



501
TORTORA/PELTRO BRONZATO
TAUPE|BRONZE PEWTER



H37
ORO/PELTRO BRONZATO
GOLD|BRONZE PEWTER

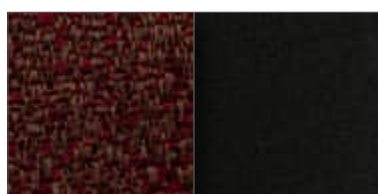

451
BORDEAUX/PELTRO BRONZATO
BURGUNDY|BRONZE PEWTER



502
VERDE/PELTRO BRONZATO
GREEN|BRONZE PEWTER



500
TESTA DI MORO/PELTRO BRONZATO
DARK BROWN|BRONZE PEWTER

CAT.A

749 MISTO COTONE DAMASCO/ACCIAIO VERNICIATO - COTTON MIX DAMASCO/PAINTED STEEL

Cocky



596
BIANCO/NERO
WHITE/BLACK



604
BLU/NERO
BLU/BLACK

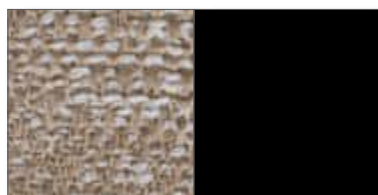

651
SABBIA/NERO
SAND/BLACK

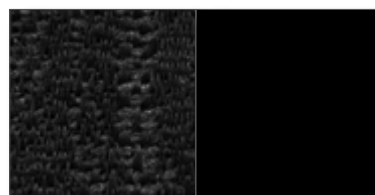

632
NERO/NERO
BLACK/BLACK



655
TORTORA/NERO
TAUPE/BLACK

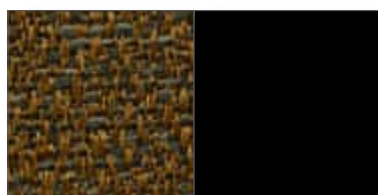

H40
ORO/NERO
GOLD/BLACK

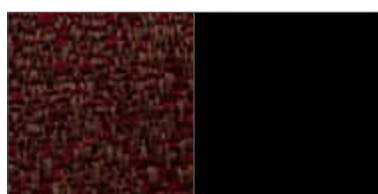

605
BORDEAUX/NERO
BURGUNDY/BLACK

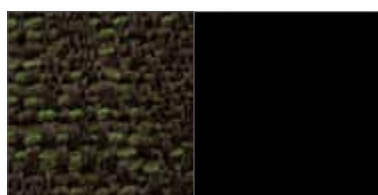

656
VERDE/NERO
GREEN/BLACK

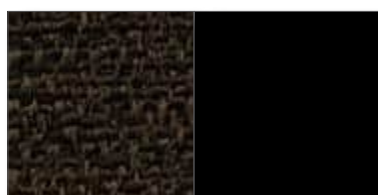

654
TESTA DI MORO/NERO
DARK BROWN/BLACK

CAT.A

750 MISTO COTONE DAMASCO/ALLUMINIO LUCIDATO - COTTON MIX DAMASCO/POLISHED ALUMINUM

Lou Speak, Cocky

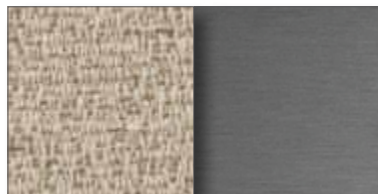

531
BIANCO/ALLUMINIO
WHITE/ALUMINUM

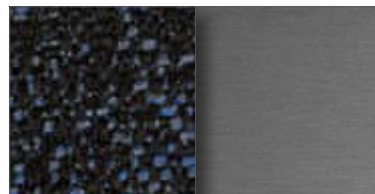

536
BLU/ALLUMINIO
BLUE/ALUMINUM

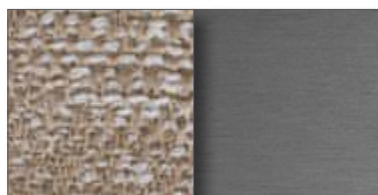

578
SABBIA/ALLUMINIO
SAND/ALUMINUM

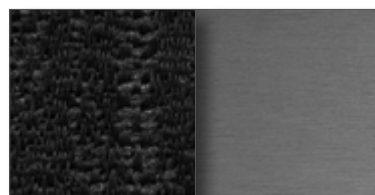

561
NERO/ALLUMINIO
BLACK/ALUMINUM

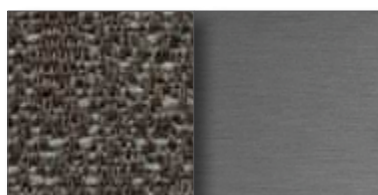

582
TORTORA/ALLUMINIO
TAUPE/ALUMINUM

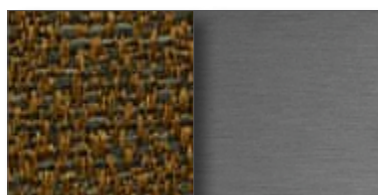

H41
ORO/ALLUMINIO
GOLD/ALUMINUM

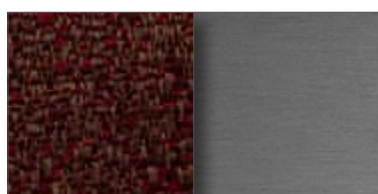

537
BORDEAUX/ALLUMINIO
BURGUNDY/ALUMINUM

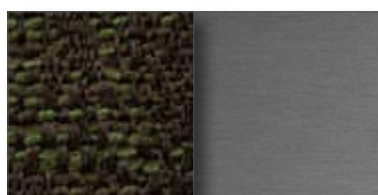

583
VERDE/ALLUMINIO
GREEN/ALUMINUM

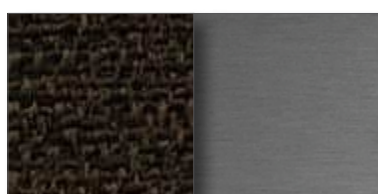

581
TESTA DI MORO/ALLUMINIO
DARK BROWN/ALUMINUM

CAT.A

751 MISTO COTONE DAMASCO/ALLUMINIO VERNICIATO - COTTON MIX DAMASCO/PAINTED ALUMINUM

Lirica, Lirico

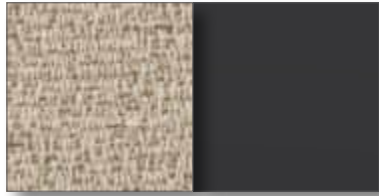

596
BIANCO/NERO
WHITE/BLACK

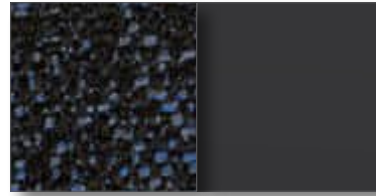

604
BLU/NERO
BLUE/BLACK

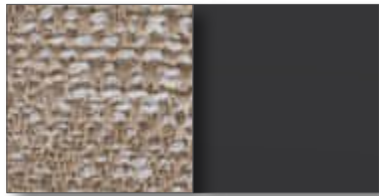

651
SABBIA/NERO
SAND/BLACK

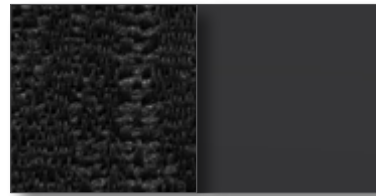

632
NERO/NERO
BLACK/BLACK

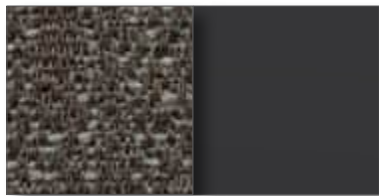

655
TORTORA/NERO
TAUPE/BLACK

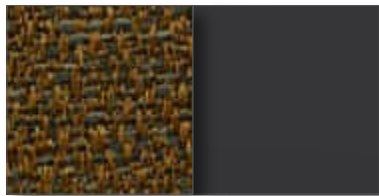

H40
ORO/NERO
GOLD/BLACK

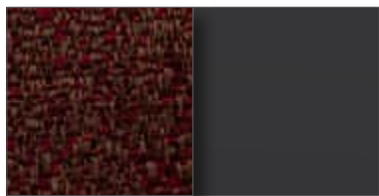

605
BORDEAUX/NERO
BURGUNDY/BLACK

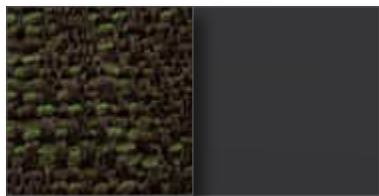

656
VERDE/NERO
GREEN/BLACK

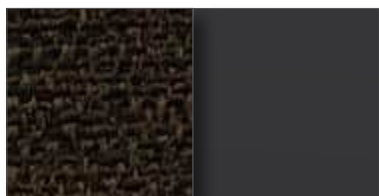

654
TESTA DI MORO/NERO
DARK BROWN/BLACK

CAT.A

751 MISTO COTONE DAMASCO/ALLUMINIO VERNICIATO - COTTON MIX DAMASCO/PAINTED ALUMINUM

Lirica, Lirico



722
BIANCO/ARGENTO
WHITE/SILVER



730
BLU/ARGENTO
BLUE/SILVER



778
SABBIA/ARGENTO
SAND/SILVER



759
NERO/ARGENTO
BLACK/SILVER



782
TORTORA/ARGENTO
TAUPE/SILVER



H42
ORO/ARGENTO
GOLD/SILVER



731
BORDEAUX/ARGENTO
BURGUNDY/SILVER



783
VERDE/ARGENTO
GREEN/SILVER



781
TESTA DI MORO/ARGENTO
DARK BROWN/SILVER

CAT.A

754 MISTO COTONE DAMASCO/FAGGIO LACCATO - COTTON MIX DAMASCO/LACQUERED BEECH

S.Marco, S.Marco Lounge



596
BIANCO/NERO
WHITE/BLACK



604
BLU/NERO
BLUE/BLACK



651
SABBIA/NERO
SAND/BLACK

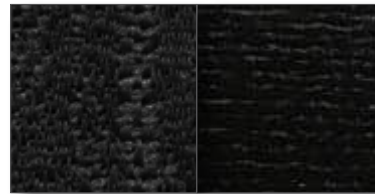

632
NERO/NERO
BLACK/BLACK



655
TORTORA/NERO
TAUPE/BLACK

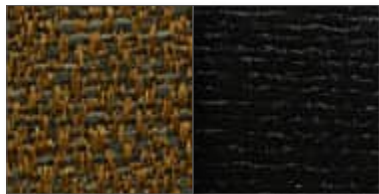

H40
ORO/NERO
GOLD/BLACK

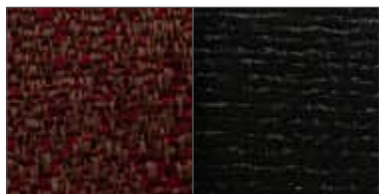

605
BORDEAUX/NERO
BURGUNDY/BLACK



656
VERDE/NERO
GREEN/BLACK

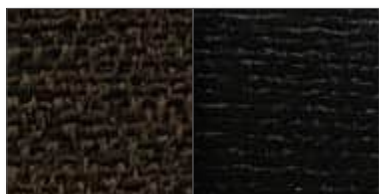

654
TESTA DI MORO/NERO
DARK BROWN/BLACK

CAT.A

755 PU RIGIDO VERNICIATO/MISTO COTONE DAMASCO/ACCIAIO CROMATO
STIFF PAINTED PU/COTTON MIX DAMASCO/CHROMED STEEL

Moon

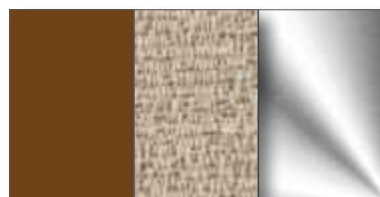

864
MATTONE/BIANCO/CROMO
BRICK RED/WHITE/CHROME

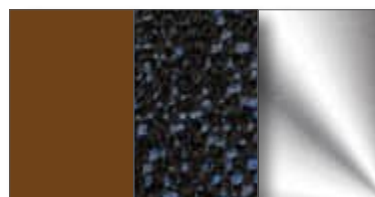

871
MATTONE/BLU/CROMO
BRICK RED/BLUE/CHROME

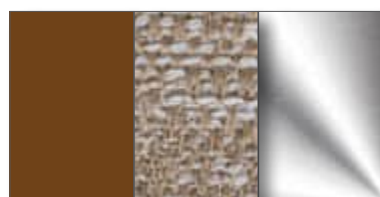

917
MATTONE/SABBIA/CROMO
BRICK RED/SAND/CHROME

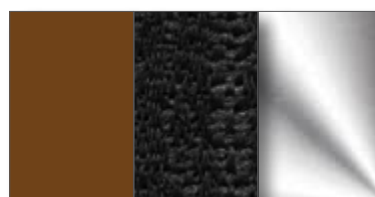

899
MATTONE/NERO/CROMO
BRICK RED/BLACK/CHROME

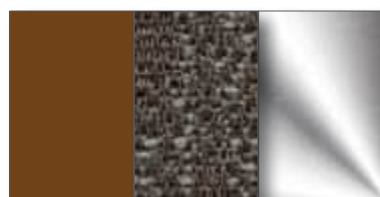

920
MATTONE/TORTORA/CROMO
BRICK RED/TAUPE/CHROME

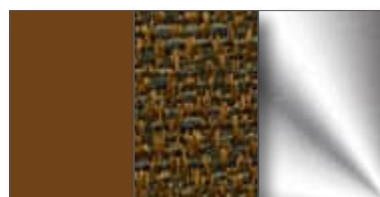

H43
MATTONE/ORO/CROMO
BRICK RED/ORO/CHROME

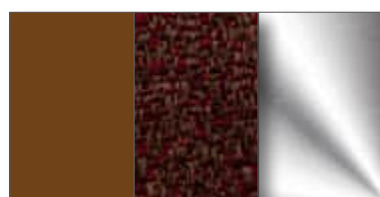

872
MATTONE/BORDEAUX/CROMO
BRICK RED/BURGUNDY/CHROME

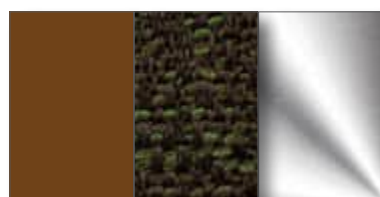

921
MATTONE/VERDE/CROMO
BRICK RED/GREEN/CHROME

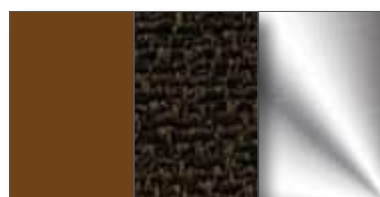

919
MATTONE/TESTA DI MORO/CROMO
BRICK RED/DARK BROWN/CHROME

CAT.A

755 PU RIGIDO VERNICIATO/MISTO COTONE DAMASCO/ACCIAIO CROMATO
STIFF PAINTED PU/COTTON MIX DAMASCO/CHROMED STEEL

Moon

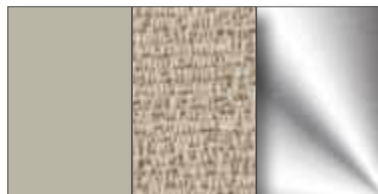

936
ECRU'/BIANCO/CROMO
ECRU'/WHITE/CHROME

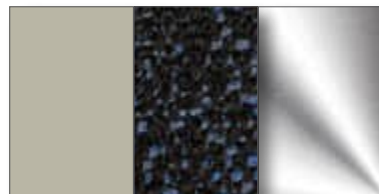

943
ECRU'/BLU/CROMO
ECRU'/BLUE/CHROME

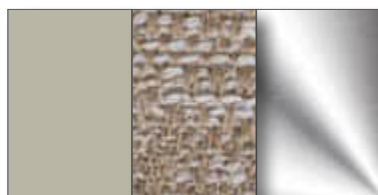

989
ECRU'/SABBIA/CROMO
ECRU'/SAND/CHROME

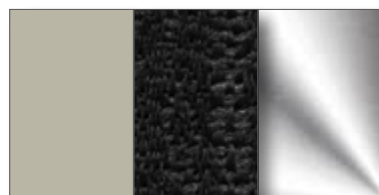

971
ECRU'/NERO/CROMO
ECRU'/BLACK/CHROME

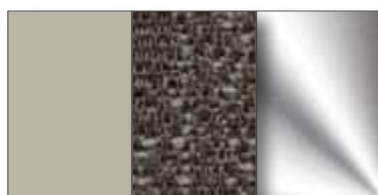

992
ECRU'/TORTORA/CROMO
ECRU'/TAUPE/CHROME

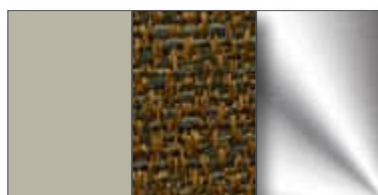

H44
ECRU'/ORO/CROMO
ECRU'/ORO/CHROME

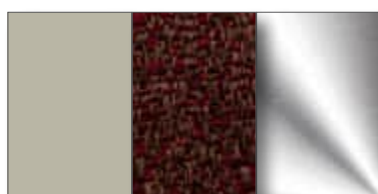

944
ECRU'/BORDEAUX/CROMO
ECRU'/BURGUNDY/CHROME

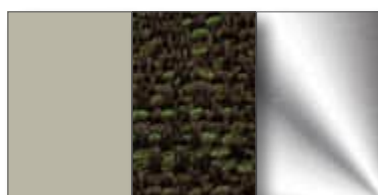

993
ECRU'/VERDE/CROMO
ECRU'/GREEN/CHROME

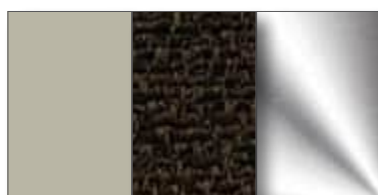

991
ECRU'/TESTA DI MORO/CROMO
ECRU'/DARK BROWN/CHROME

CAT.A

755 PU RIGIDO VERNICIATO/MISTO COTONE DAMASCO/ACCIAIO CROMATO
STIFF PAINTED PU/COTTON MIX DAMASCO/CHROMED STEEL

Moon

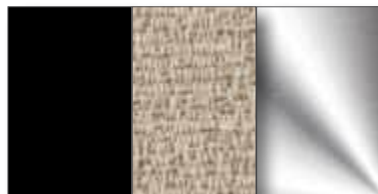

A08
NERO/BIANCO/CROMO
BLACK/WHITE/CHROME

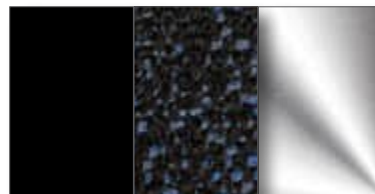

A15
NERO/BLU/CROMO
BLACK/BLUE/CHROME

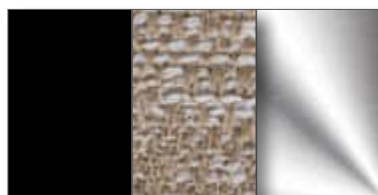

A61
NERO/SABBIA/CROMO
BLACK/SAND/CHROME

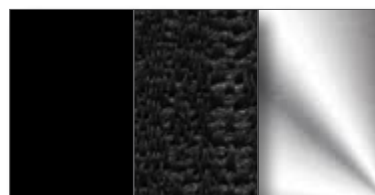

A43
NERO/NERO/CROMO
BLACK/BLACK/CHROME

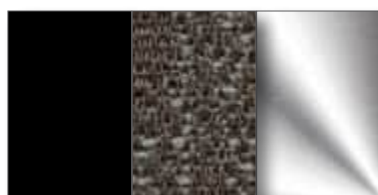

A64
NERO/TORTORA/CROMO
BLACK/TAUPE/CHROME

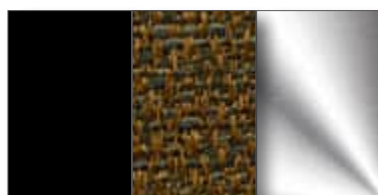

H45
NERO/ORO/CROMO
BLACK/GOLD/CHROME

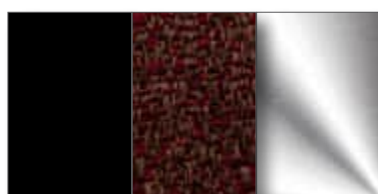

A16
NERO/BORDEAUX/CROMO
BLACK/BURGUNDY/CHROME

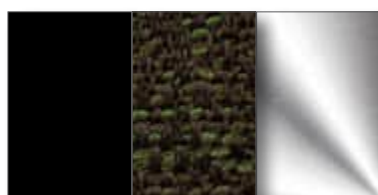

A65
NERO/VERDE/CROMO
BLACK/GREEN/CHROME

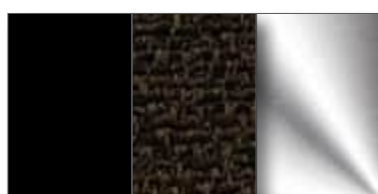

A63
NERO/TESTA DI MORO/CROMO
BLACK/DARK BROWN/CHROME

CAT.A

871 MISTO COTONE DAMASCO/ACCIAIO CROMATO
COTTON MIX DAMASCO/CHROMED STEEL

Cocky



B00
BIANCO/CROMO
WHITE/CHROME



C40
BLU/CROMO
BLUE/CHROME



C59
SABBIA/CROMO
SAND/CHROME

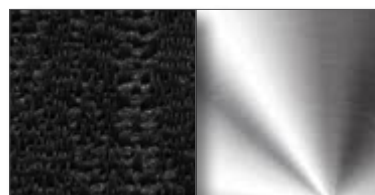

B01
NERO/CROMO
BLACK/CHROME

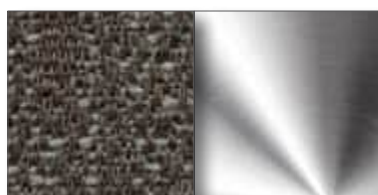

E86
TORTORA/CROMO
TAUPE/CHROME

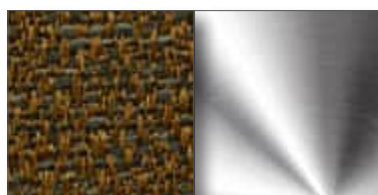

H46
ORO/CROMO
GOLD/CHROME



C41
BORDEAUX/CROMO
BURGUNDY/CHROME



H26
VERDE/CROMO
GREEN/CHROME



C62
TESTA DI MORO/CROMO
DARK BROWN/CHROME

CAT.A

028 ECOPELLE COLORADO - COLORADO ECOLEATHER

Composizione/Composition: 68% PVC, 30% CO, 2% PU. Altezza/Height: 140 cm. Peso/Weight: 460 gr/mq. Abrasione/Abrasion: 100.000 Martindale (uso pubblico, uso molto intensivo/
public use, very intensive use). Spessore/Thickness 1.0/1.1 mm

PULIRE SOLO CON PANNINO UMIDO E DETERGENTE NEUTRO/CLEAN ONLY WITH A DAMP CLOTH AND A NEUTRAL DETERGENT



002
BIANCO
WHITE



004
AVORIO
IVORY



015
BEIGE
BEIGE



039
ROSSO
RED



066
VERDE SCURO
DARK GREEN



072
BLU
BLUE



045
GRIGIO CHIARO
LIGHT GREY

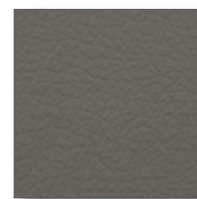

044
GRIGIO
GREY

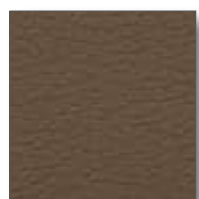

081
MARRONE
BROWN

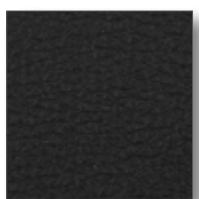

091
NERO
BLACK



042
PERLA
PEARL



077
RUGGINE
RUSSET

I colori sono indicativi. Non è possibile garantire uniformità di tono nella tintura dei lotti di tessuto. Resta inteso che lievi differenze di colore verranno accettate al momento dell'ordine.

The colors are just indicative. Actually a steady tone of lots cannot be guaranteed. It remains understood that any slight colour difference will be accepted in case an order is placed.

CAT.A

126 ECOPELLE COLORADO/ACCIAIO VERNICIATO - COLORADO ECOLEATHER/PAINTED STEEL

Fenix

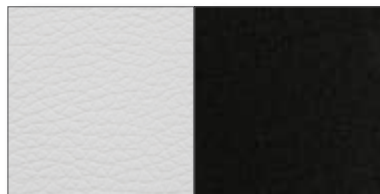

442
BIANCO/PELTRO BRONZATO
WHITE/BRONZE PEWTER

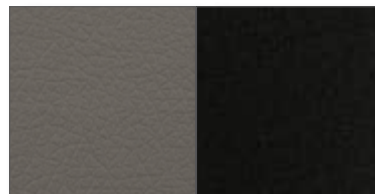

461
GRIGIO/PELTRO BRONZATO
GREY/BRONZE PEWTER

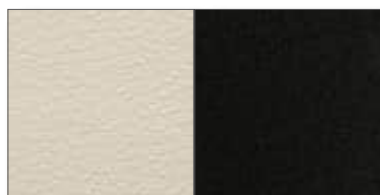

436
AVORIO/PELTRO BRONZATO
IVORY/BRONZE PEWTER

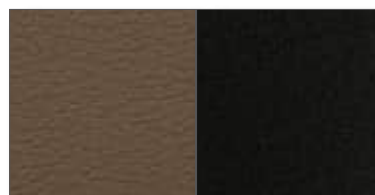

478
MARRONE/PELTRO BRONZATO
BROWN/BRONZE PEWTER

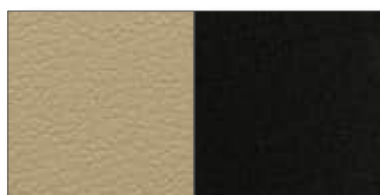

441
BEIGE/PELTRO BRONZATO
BEIGE/BRONZE PEWTER



479
NERO/PELTRO BRONZATO
BLACK/BRONZE PEWTER



494
ROSSO/PELTRO BRONZATO
RED/BRONZE PEWTER



485
PERLA/PELTRO BRONZATO
PEARL/BRONZE PEWTER

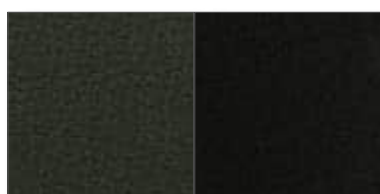

507
VERDE SCURO/PELTRO BRONZATO
DARK GREEN/BRONZE PEWTER



495
RUGGINE/PELTRO BRONZATO
RUSSET/BRONZE PEWTER

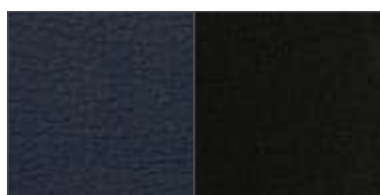

450
BLU/PELTRO BRONZATO
BLUE/BRONZE PEWTER

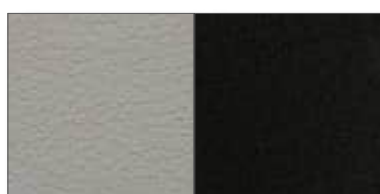

466
GRIGIO CHIARO/PELTRO BRONZATO
LIGHT GREY/BRONZE PEWTER

CAT.A

191 ECOPELLE COLORADO/ALLUMINIO LUCIDATO - COLORADO ECOLEATHER/POLISHED ALUMINUM

Cocky

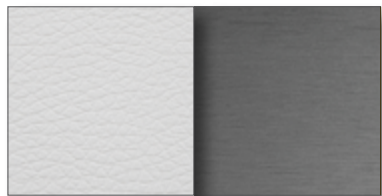

531
BIANCO/ALLUMINIO
WHITE/ALUMINUM

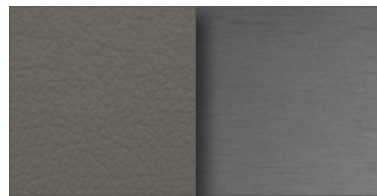

545
GRIGIO/ALLUMINIO
GREY/ALUMINUM

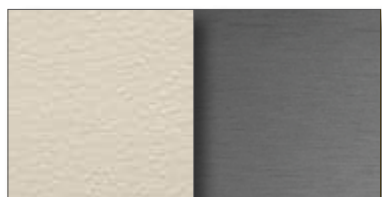

526
AVORIO/ALLUMINIO
IVORY/ALUMINUM

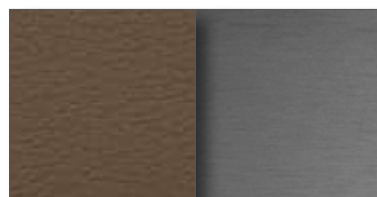

560
MARRONE/ALLUMINIO
BROWN/ALUMINUM



530
BEIGE/ALLUMINIO
BEIGE/ALUMINUM

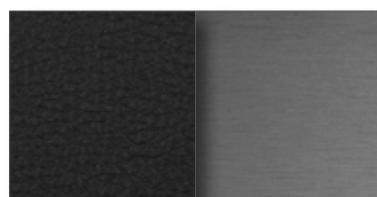

561
NERO/ALLUMINIO
BLACK/ALUMINUM

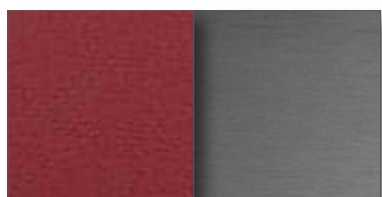

575
ROSSO/ALLUMINIO
RED/ALUMINUM

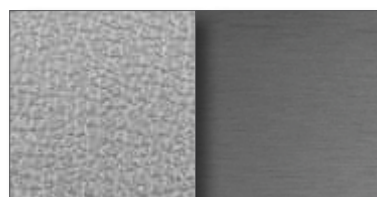

567
PERLA/ALLUMINIO
PEARL/ALUMINUM

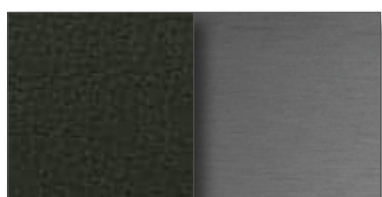

585
VERDE SCURO/ALLUMINIO
DARK GREY/ALUMINUM



576
RUGGINE/ALLUMINIO
RUSSET/ALUMINUM

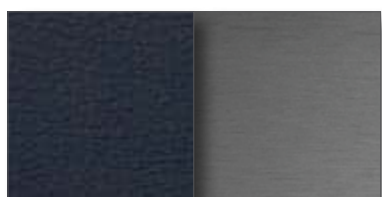

536
BLU/ALLUMINIO
BLUE/ALUMINUM

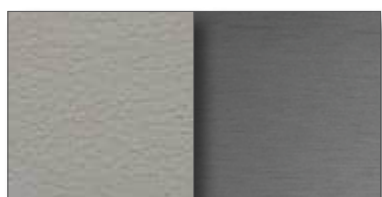

550
GRIGIO CHIARO/ALLUMINIO
LIGHT GREY/ALUMINUM

CAT.A

220 ECOPELLE COLORADO/ALLUMINIO VERNICIATO - *ECOLEATHER COLORADO/PAINTED ALUMINUM*

Lirica, Lirico

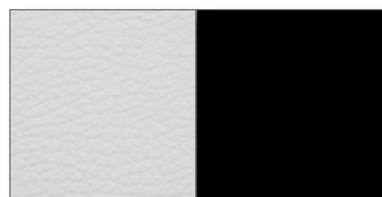

596
BIANCO/NERO
WHITE/BLACK

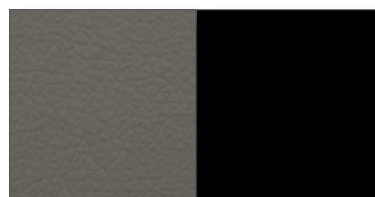

615
GRIGIO/NERO
GREY/BLACK

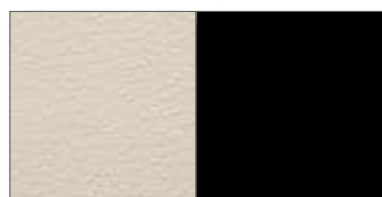

590
AVORIO/NERO
IVORY/BLACK

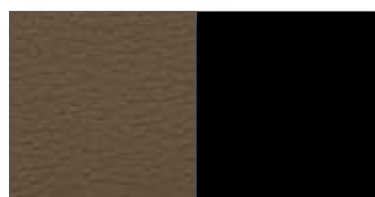

631
MARRONE/NERO
BROWN/BLACK

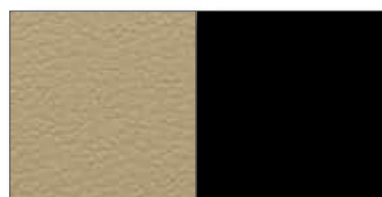

595
BEIGE/NERO
BEIGE/BLACK

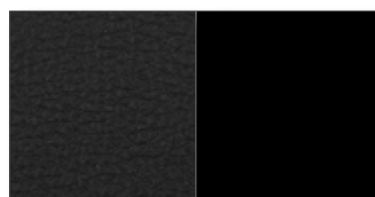

632
NERO/NERO
BLACK/BLACK

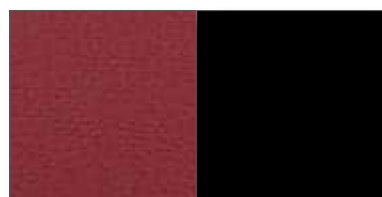

647
ROSSO/NERO
RED/BLACK



638
PERLA/NERO
PEARL/BLACK

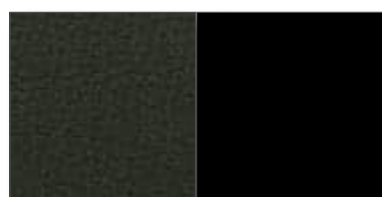

661
VERDE SCURO/NERO
DARK GREEN/BLACK



648
RUGGINE/NERO
RUSSET/BLACK

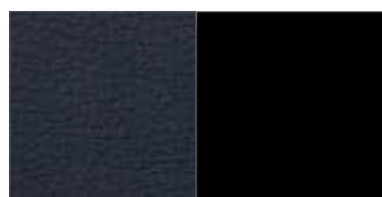

604
BLU/NERO
BLUE/BLACK



620
GRIGIO CHIARO/NERO
LIGHT GREY/BLACK

CAT.A

220 ECOPELLE COLORADO/ALLUMINIO VERNICIATO - *ECOLEATHER COLORADO/PAINTED ALUMINUM*

Lirica, Lirico

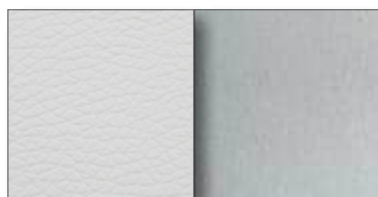

722
BIANCO/ARGENTO
WHITE/SILVER

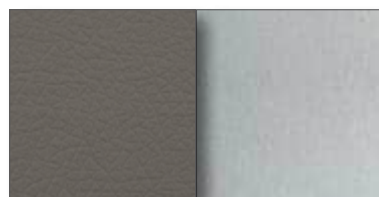

741
GRIGIO/ARGENTO
GREY/SILVER



716
AVORIO/ARGENTO
IVORY/SILVER



758
MARRONE/ARGENTO
BROWN/SILVER



721
BEIGE/ARGENTO
BEIGE/SILVER



759
NERO/ARGENTO
BLACK/SILVER



774
ROSSO/ARGENTO
RED/SILVER



765
PERLA/ARGENTO
PEARL/SILVER



788
VERDE SCURO/ARGENTO
DARK GREEN/SILVER



775
RUGGINE/ARGENTO
RUSSET/SILVER



730
BLU/ARGENTO
BLUE/SILVER



746
GRIGIO CHIARO/ARGENTO
LIGHT GREY/SILVER

CAT.A

126 ECOPELLE COLORADO/ACCIAIO VERNICIATO - ECOLLEATHER COLORADO/PAINTED STEEL

Cocky

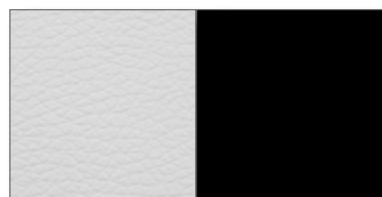

596
BIANCO/NERO
WHITE/BLACK

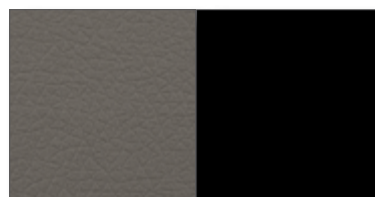

615
GRIGIO/NERO
GREY/BLACK

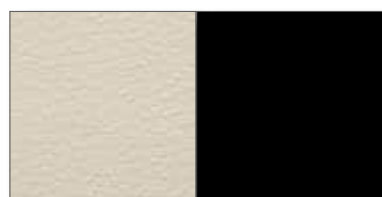

590
AVORIO/NERO
IVORY/BLACK

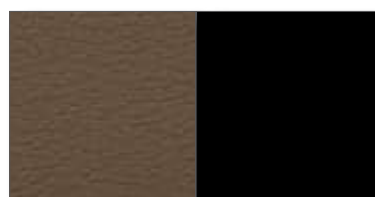

631
MARRONE/NERO
BROWN/BLACK

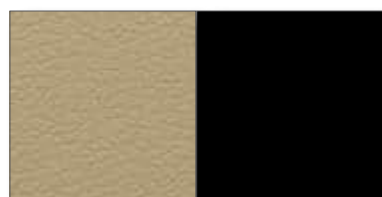

595
BEIGE/NERO
BEIGE/BLACK

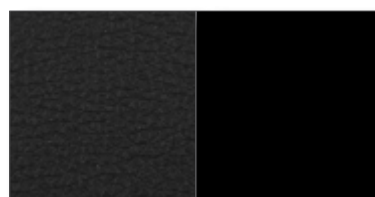

632
NERO/NERO
BLACK/BLACK

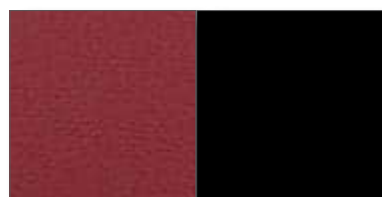

647
ROSSO/NERO
RED/BLACK



638
PERLA/NERO
PEARL/BLACK

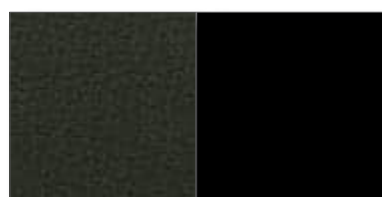

661
VERDE SCURO/NERO
DARK GREEN/BLACK

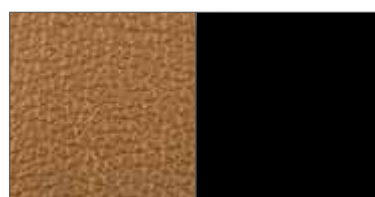

648
RUGGINE/NERO
RUSSET/BLACK

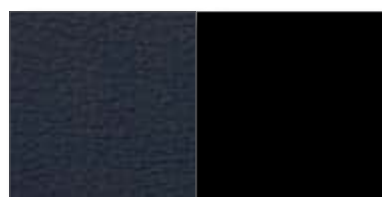

604
BLU/NERO
BLUE/BLACK



620
GRIGIO CHIARO/NERO
LIGHT GREY/BLACK

CAT.A

313 ECOPELLE COLORADO/FAGGIO LACCATO - ECOLEATHER COLORADO/LACQUERED BEECH

S.Marco, S.Marco Lounge

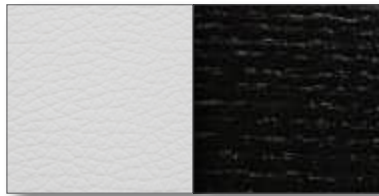

596
BIANCO/NERO
WHITE/BLACK

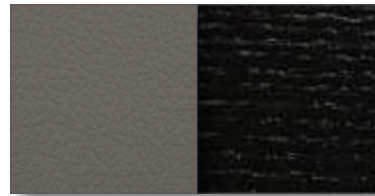

615
GRIGIO/NERO
GREY/BLACK

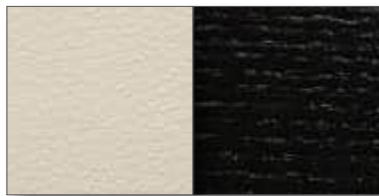

590
AVORIO/NERO
IVORY/BLACK



631
MARRONE/NERO
BROWN/BLACK



595
BEIGE/NERO
BEIGE/BLACK

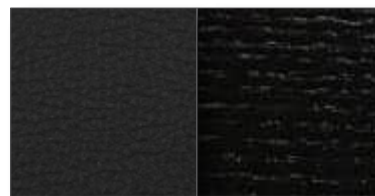

632
NERO/NERO
BLACK/BLACK



647
ROSSO/NERO
RED/BLACK

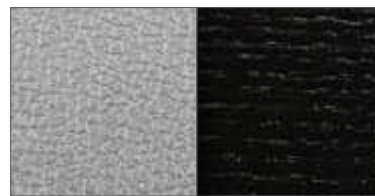

638
PERLA/NERO
PERL/BLACK



661
VERDE SCURO/NERO
DARK GREEN/BLACK



648
RUGGINE/NERO
RUSSET/BLACK



604
BLU/NERO
BLUE/BLACK



620
GRIGIO CHIARO/NERO
LIGHT GREY/BLACK

CAT.A

395 PU RIGIDO VERNICIATO/ECOPELLE COLORADO/ACCIAIO CROMATO
STIFF PAINTED PU/COLORADO ECOLEATHER/CHROMED STEEL

Moon

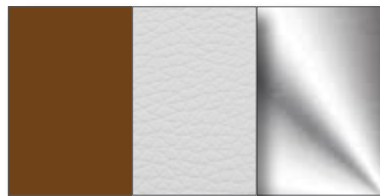

864
MATTONE/BIANCO/CROMO
RED BRICK/WHITE/CHROME

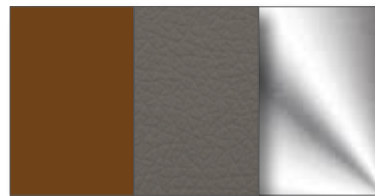

881
MATTONE/GRIGIO/CROMO
RED BRICK/GREY/CHROME



859
MATTONE/AVORIO/CROMO
RED BRICK/IVORY/CHROME

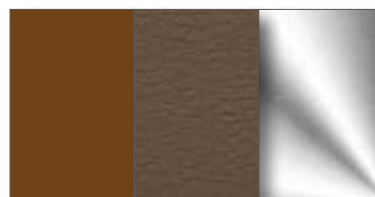

898
MATTONE/MARRONE/CROMO
RED BRICK/BROWN/CHROME



863
MATTONE/BEIGE/CROMO
RED BRICK/BEIGE/CHROME

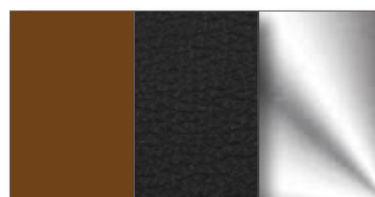

899
MATTONE/NERO/CROMO
RED BRICK/BLACK/CHROME

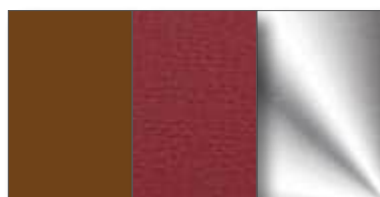

886
MATTONE/ROSSO/CROMO
RED BRICK/RED/CHROME

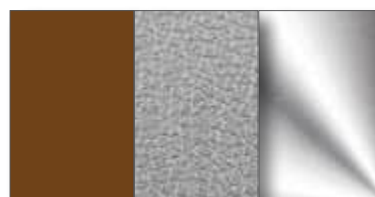

904
MATTONE/PERLA/CROMO
RED BRICK/PEARL/CHROME

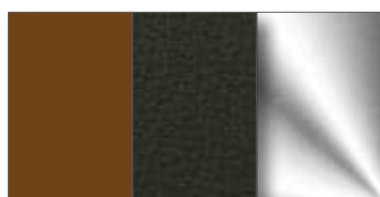

926
MATTONE/VERDE SCURO/CROMO
RED BRICK/DARK GREEN/CHROME

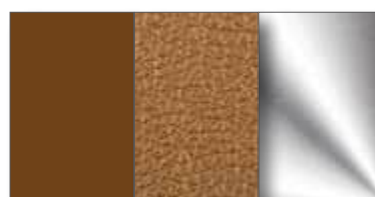

914
MATTONE/RUGGINE/CROMO
RED BRICK/RUSSET/CHROME

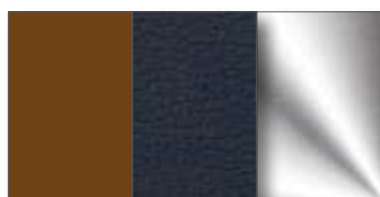

871
MATTONE/BLU/CROMO
RED BRICK/BLUE/CHROME

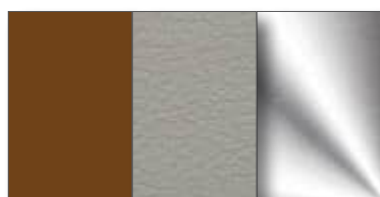

886
MATTONE/GRIGIO CHIARO/CROMO
RED BRICK/LIGHT GREY/CHROME

CAT.A

395 PU RIGIDO VERNICIATO/ECOPELLE COLORADO/ACCIAIO CROMATO
STIFF PAINTED PU/COLORADO ECOLEATHER/CHROMED STEEL

Moon

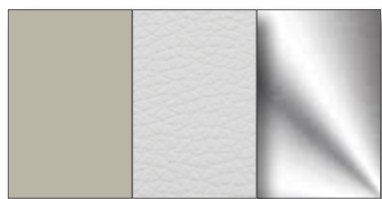

936
ECRU/BIANCO/CROMO
ECRU/WHITE/CHROME

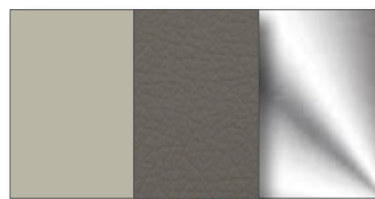

953
ECRU/GRIGIO/CROMO
ECRU/GREY/CHROME



931
ECRU/AVORIO/CROMO
ECRU/IVORY/CHROME

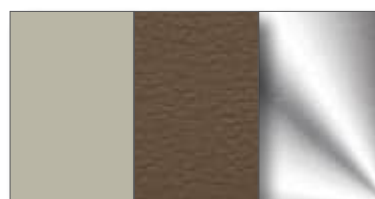

970
ECRU/MARRONE/CROMO
ECRU/BROWN/CHROME



935
ECRU/BEIGE/CROMO
ECRU/BEIGE/CHROME

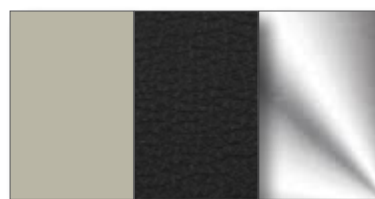

971
ECRU/NERO/CROMO
ECRU/BLACK/CHROME



985
ECRU/ROSSO/CROMO
ECRU/RED/CHROME

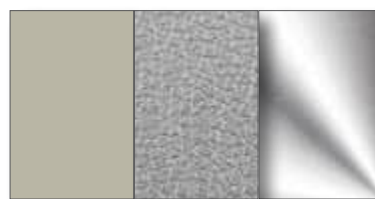

976
ECRU/PERLA/CROMO
ECRU/PEARL/CHROME

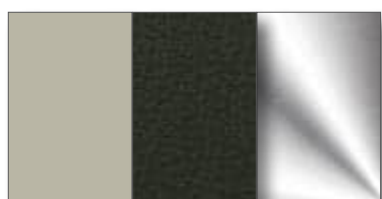

998
ECRU/VERDE SCURO/CROMO
ECRU/DARK GREEN/CHROME



986
ECRU/RUGGINE/CROMO
ECRU/RUSSET/CHROME

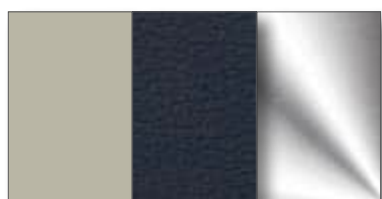

943
ECRU/BLU/CROMO
ECRU/BLUE/CHROME



958
ECRU/GRIGIO CHIARO/CROMO
ECRU/LIGHT GREY/CHROME

CAT.A

395 PU RIGIDO VERNICIATO/ECOPELLE COLORADO/ACCIAIO CROMATO
STIFF PAINTED PU/COLORADO ECOLEATHER/CHROMED STEEL

Moon



A08
NERO/BIANCO/CROMO
BLACK/WHITE/CHROME

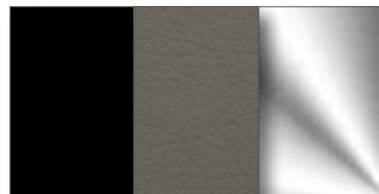

A25
NERO/GRIGIO/CROMO
BLACK/GREY/CHROME

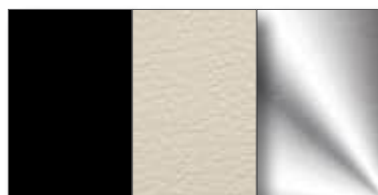

A03
NERO/AVORIO/CROMO
BLACK/IVORY/CHROME

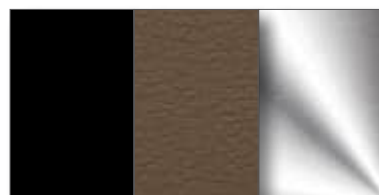

A42
NERO/MARRONE/CROMO
BLACK/BROWN/CHROME

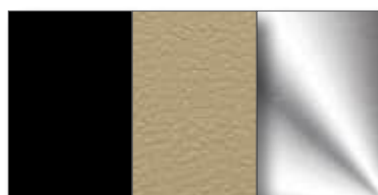

A07
NERO/BEIGE/CROMO
BLACK/BEIGE/CHROME

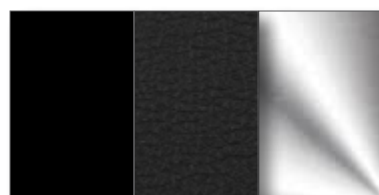

A43
NERO/NERO/CROMO
BLACK/BLACK/CHROME

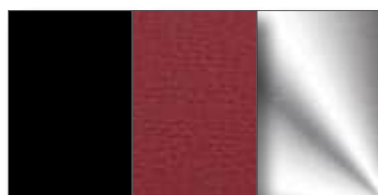

A57
NERO/ROSSO/CROMO
BLACK/RED/CHROME

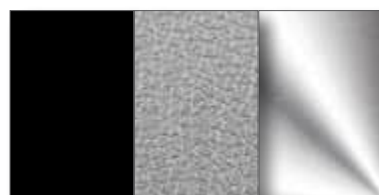

A48
NERO/PERLA/CROMO
BLACK/PEARL/CHROME

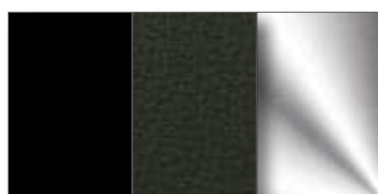

A70
NERO/VERDE SCURO/CROMO
BLACK/DARK GREEN/CHROME

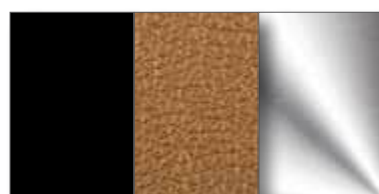

A58
NERO/RUGGINE/CROMO
BLACK/RUSSET/CHROME

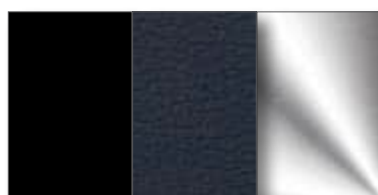

A15
NERO/BLU/CROMO
BLACK/BLUE/CHROME

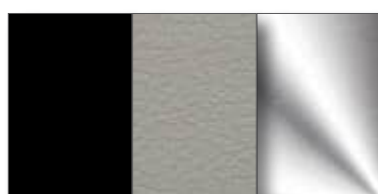

A30
NERO/GRIGIO CHIARO/CROMO
BLACK/LIGHT GREY/CHROME

CAT.A

605 ECOPELLE COLORADO/ACCIAIO CROMATO
 COLORADO ECOLEATHER/CHROMED STEEL

Cocky

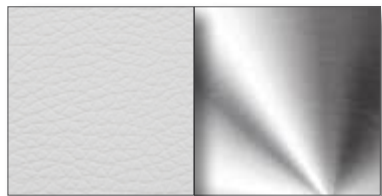

B00
 BIANCO/CROMO
 WHITE/CHROME

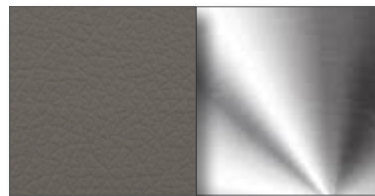

C48
 GRIGIO/CROMO
 GREY/CHROME



C36
 AVORIO/CROMO
 IVORY/CHROME



C54
 MARRONE/CROMO
 BROWN/CHROME



C38
 BEIGE/CROMO
 BEIGE/CHROME



B01
 NERO/CROMO
 BLACK/CHROME



C58
 ROSSO/CROMO
 RED/CHROME



I18
 PERLA/CROMO
 PERL/CHROME



C63
 VERDE SCURO/CROMO
 DARK GREEN/CHROME



I19
 RUGGINE/CROMO
 RUSSET/CHROME



C40
 BLU/CROMO
 BLUE/CHROME



C51
 GRIGIO CHIARO/CROMO
 LIGHT GREY/CHROME

CAT.B

704 MISTO POLIESTERE BERLINO - *POLYESTER MIX BERLINO*

Composizione/Composition: 68% PL, 20% CO, 12% LI. Altezza/Height: 140 cm. Peso/Weight: 670gr. Abrasione/Abrasion: 65.000 Martindale (uso pubblico, uso molto intensivo/public use, very intensive use). BS5852, Antigoccia, idrorepellente/Anti-drip, water repellent.

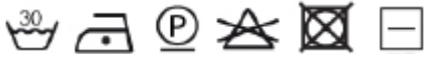

004
AVORIO
IVORY



011
SABBIA
SAND

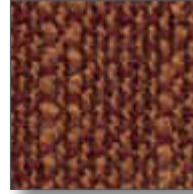

033
ARANCIO
ORANGE



H03
VERDE ACQUA
AQUA GREEN



063
VERDE
GREEN

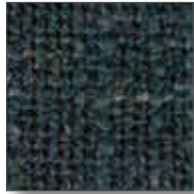

070
BLU CHIARO
LIGHT BLUE



050
GRIGIO SCURO
DARK GREY

I colori sono indicativi. Non è possibile garantire uniformità di tono nella tintura dei lotti di tessuto. Resta inteso che lievi differenze di colore verranno accettate al momento dell'ordine.

The colors are just indicative. Actually a steady tone of lots cannot be guaranteed. It remains understood that any slight colour difference will be accepted in case an order is placed.

CAT.B

720 MISTO POLIESTERE BERLINO/FRASSINO - POLYESTER MIX BERLINO/ASH

La Francesea



172
AVORIO/NATURALE
IVORY/NATURAL

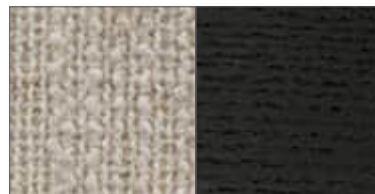

233
AVORIO/EBANIZZATO
IVORY/EBONIZED



221
SABBIA/NATURALE
SAND/NATURAL

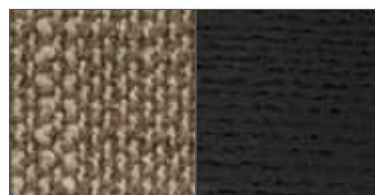

282
SABBIA/EBANIZZATO
SAND/EBONIZED

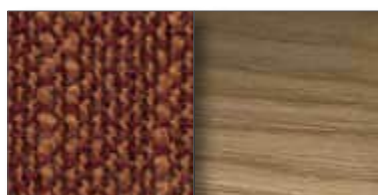

H47
ARANCIO/NATURALE
ORANGE/NATURAL

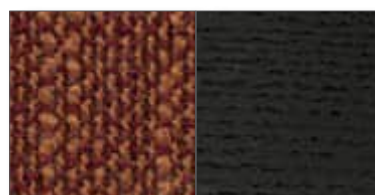

H48
ARANCIO/EBANIZZATO
ORANGE/EBONIZED

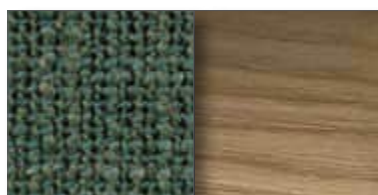

H04
VERDE ACQUA/NATURALE
AQUA GREEN/NATURAL

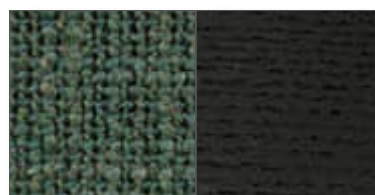

H05
VERDE ACQUA/EBANIZZATO
AQUA GREEN/EBONIZED

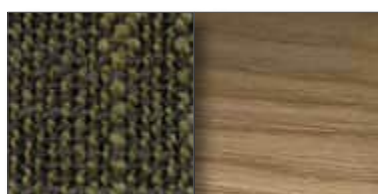

225
VERDE/NATURALE
GREEN/NATURAL

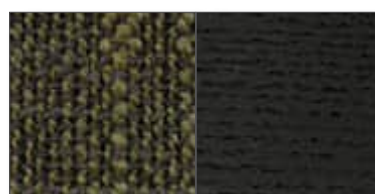

287
VERDE/EBANIZZATO
GREEN/EBONIZED



178
BLU CHIARO/NATURALE
LIGHT BLUE/NATURAL



238
BLU CHIARO/EBANIZZATO
LIGHT BLUE/EBONIZED



191
GRIGIO SCURO/NATURALE
DARK GREY/NATURAL

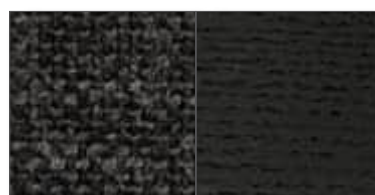

260
GRIGIO SCURO/EBANIZZATO
DARK GREY/EBONIZED

CAT.B

758 MISTO POLIESTERE BERLINO/ACCIAIO VERNICIATO - *POLYESTER MIX BERLINO/PAINTED STEEL*

Sof Sof, 33 Cuscini

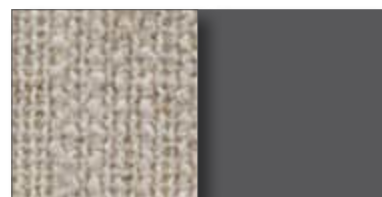

322
AVORIO/GRAFITE
IVORY/GRAPHITE

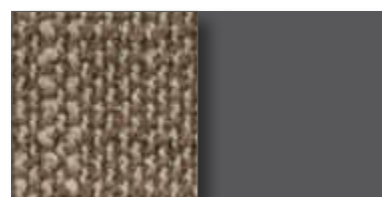

377
SABBIA/GRAFITE
SAND/GRAPHITE

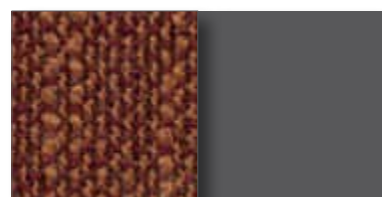

320
ARANCIO/GRAFITE
ORANGE/GRAPHITE

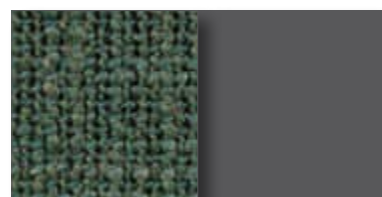

H07
VERDE ACQUA/GRAFITE
AQUA GREEN/GRAPHITE

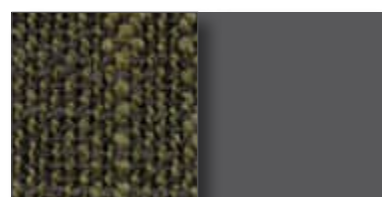

379
VERDE/GRAFITE
GREEN/GRAPHITE

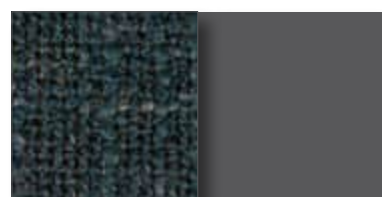

330
BLU CHIARO/GRAFITE
LIGHT BLUE/GRAPHITE

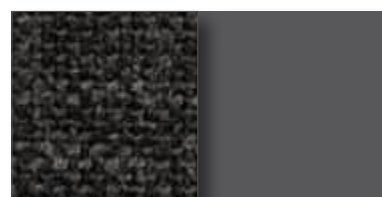

353
GRIGIO SCURO/GRAFITE
DARK GREY/GRAPHITE

33 Cuscini, Elisa

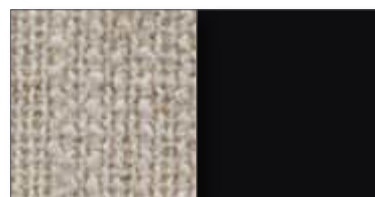

388
AVORIO/NERO MARRONE
IVORY/BLACK BROWN

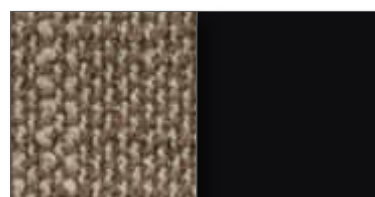

426
SABBIA/NERO MARRONE
SAND/BLACK BROWN

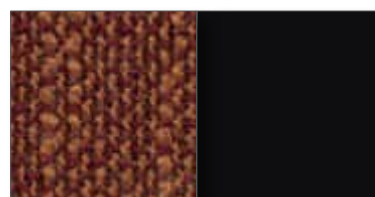

387
ARANCIO/NERO MARRONE
ORANGE/BLACK BROWN

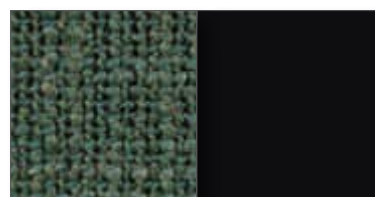

H08
VERDE ACQUA/NERO MARRONE
AQUA GREEN/BLACK BROWN

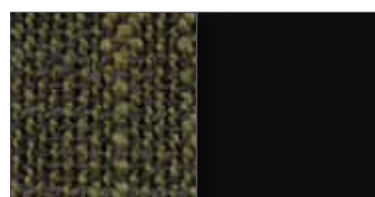

428
VERDE/NERO MARRONE
GREEN/BLACK BROWN

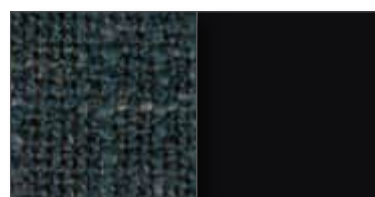

394
BLU CHIARO/NERO MARRONE
LIGHT BLUE/BLACK BROWN

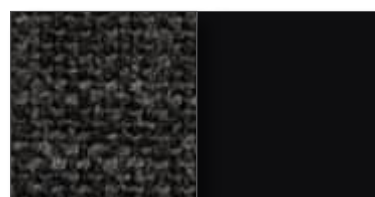

411
GRIGIO SCURO/NERO MARRONE
DARK GREY/BLACK BROWN

CAT.B

758 MISTO POLIESTERE BERLINO/ACCIAIO VERNICIATO - *POLYESTER MIX BERLINO/PAINTED STEEL*

Fenix



436
AVORIO/PELTRO BRONZATO
IVORY/BRONZE PEWTER

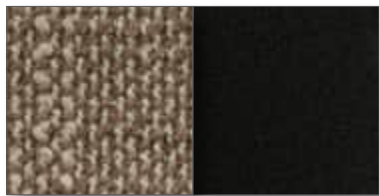

498
SABBIA/PELTRO BRONZATO
SAND/BRONZE PEWTER

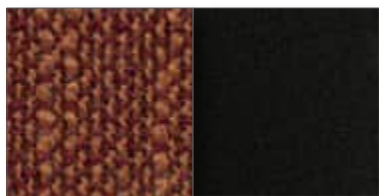

H51
ARANCIO/PELTRO BRONZATO
ORANGE/BRONZE PEWTER

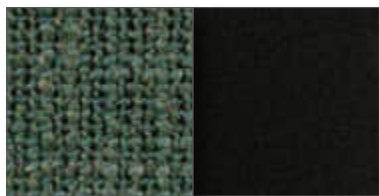

H09
VERDE ACQUA/PELTRO BRONZATO
AQUA GREEN/BRONZE PEWTER

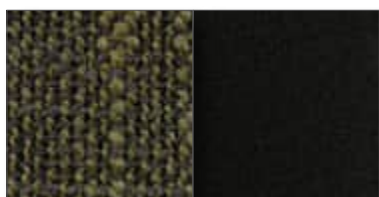

502
VERDE/PELTRO BRONZATO
GREEN/BRONZE PEWTER



444
BLU CHIARO/PELTRO BRONZATO
LIGHT BLUE/BRONZE PEWTER



471
GRIGIO SCURO/PELTRO BRONZATO
DARK GREY/BRONZE PEWTER

Cocky

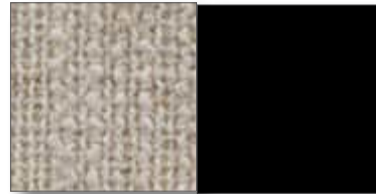

590
AVORIO/NERO
IVORY/BLACK

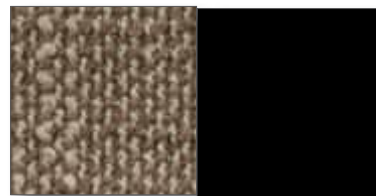

651
SABBIA/NERO
SAND/BLACK

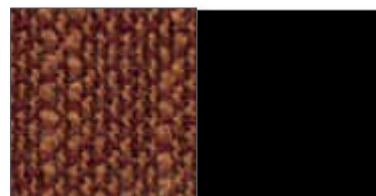

H53
ARANCIO/NERO
ORANGE/BLACK

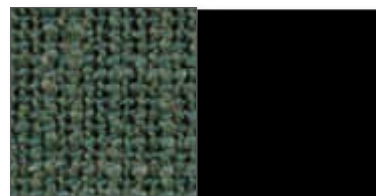

H22
VERDE ACQUA/NERO
AQUA GREEN/BLACK



656
VERDE/NERO
GREEN/BLACK

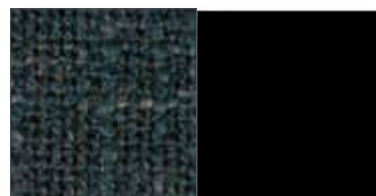

598
BLU CHIARO/NERO
LIGHT BLUE/BLACK



625
GRIGIO SCURO/NERO
DARK GREY/BLACK

CAT.B

759 MISTO POLIESTERE BERLINO/ALLUMINIO LUCIDATO - *POLYESTER MIX BERLINO/POLISHED ALUMINUM*

Lou Speak, Cocky

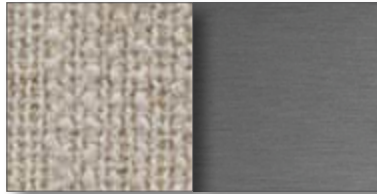

526
 AVORIO/ALLUMINIO
IVORY/ALUMINUM

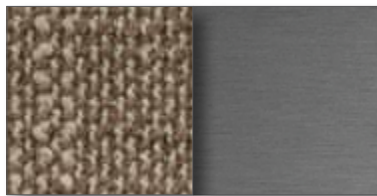

578
 SABBIA/ALLUMINIO
SAND/ALUMINUM

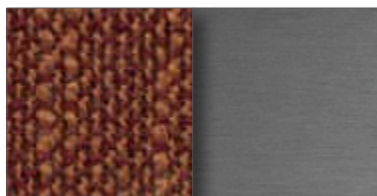

H54
 ARANCIO/ALLUMINIO
ORANGE/ALUMINUM

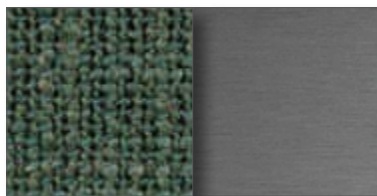

H23
 VERDE ACQUA/ALLUMINIO
AQUA GREEN/ALUMINUM

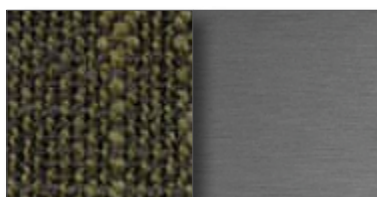

583
 VERDE/ALLUMINIO
GREEN/ALUMINUM

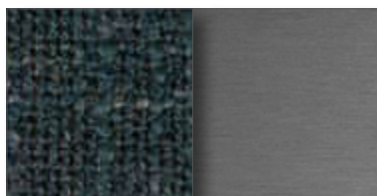

532
 BLU CHIARO/ALLUMINIO
LIGHT BLUE/ALUMINUM

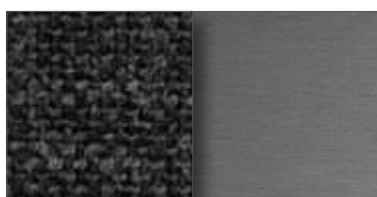

554
 GRIGIO SCURO/ALLUMINIO
DARK GREY/ALUMINUM

CAT.B

760 MISTO POLIESTERE BERLINO/ALLUMINIO VERNICIATO - POLYESTER MIX BERLINO/PAINTED ALUMINUM

Lirica, Lirico

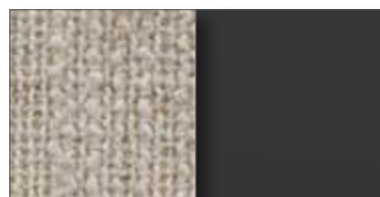

590
AVORIO/NERO
IVORY/BLACK



716
AVORIO/ARGENTO
IVORY/SILVER

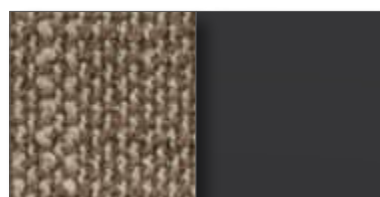

651
SABBIA/NERO
SAND/BLACK



778
SABBIA/ARGENTO
SAND/SILVER

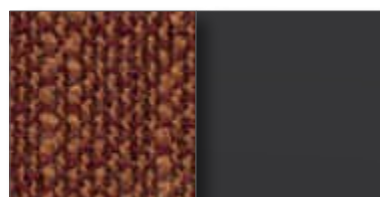

H53
ARANCIO/NERO
ORANGE/BLACK



H55
ARANCIO/ARGENTO
ORANGE/SILVER

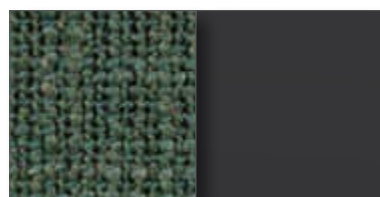

H22
VERDE ACQUA/NERO
AQUA GREEN/BLACK



H15
VERDE ACQUA/ARGENTO
AQUA GREEN/SILVER

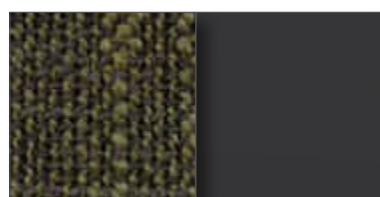

656
VERDE/NERO
GREEN/BLACK



783
VERDE/ARGENTO
GREEN/SILVER

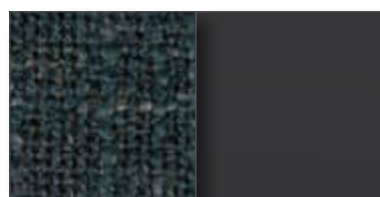

598
BLU CHIARO/NERO
LIGHT BLUE/BLACK



724
BLU CHIARO/ARGENTO
LIGHT BLUE/SILVER

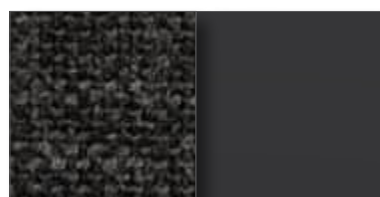

625
GRIGIO SCURO/NERO
DARK GREY/BLACK



751
GRIGIO SCURO/ARGENTO
DARK GREY/SILVER

CAT.B

763 MISTO POLIESTERE BERLINO/FAGGIO LACCATO - *POLYESTER MIX BERLINO/LACQUERED BEECH*

S.Marco, S.Marco Lounge



590
AVORIO/NERO
IVORY/BLACK



651
SABBIA/NERO
SAND/BLACK

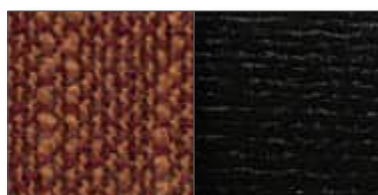

H53
ARANCIO/NERO
ORANGE/BLACK

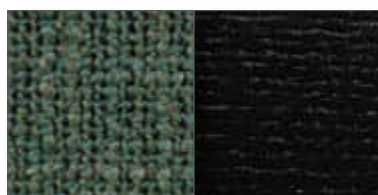

H22
VERDE ACQUA/NERO
AQUA GREEN/BLACK



656
VERDE/NERO
GREEN/BLACK



598
BLU CHIARO/NERO
LIGHT BLUE/BLACK



625
GRIGIO SCURO/NERO
DARK GREY/BLACK

CAT.B

764 PU RIGIDO VERNICIATO/MISTO POLIESTERE BERLINO/ACCIAIO CROMATO
 STIFF PAINTED PU/POLYESTER MIX BERLINO/CHROMED STEEL

Moon

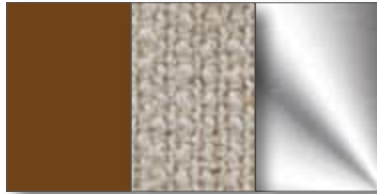

859
 MATTONE/AVORIO/CROMO
 BRICK RED/IVORY/CHROME

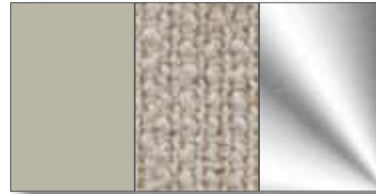

931
 ECRU'/AVORIO/CROMO
 ECRU/IVORY/CHROME

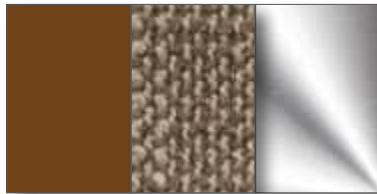

917
 MATTONE/SABBIA/CROMO
 BRICK RED/SAND/CHROME

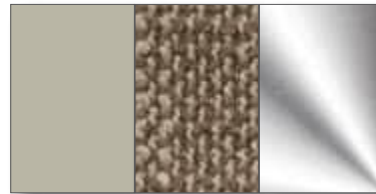

989
 ECRU'/SABBIA/CROMO
 ECRU/SAND/CHROME

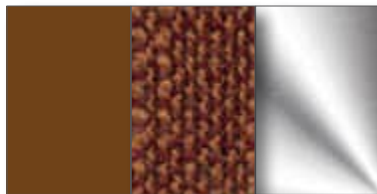

H56
 MATTONE/ARANCIO/CROMO
 BRICK RED/ORANGE/CHROME

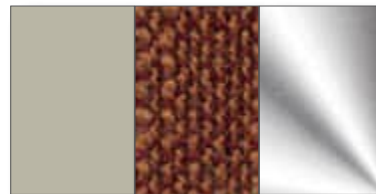

H57
 ECRU'/ARANCIO/CROMO
 ECRU/ORANGE/CHROME

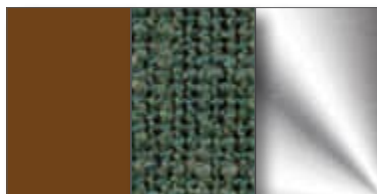

H24
 MATTONE/VERDE ACQUA/CROMO
 BRICK RED/AQUA GREEN/CHROME

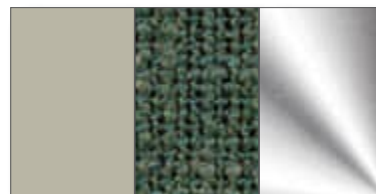

H14
 ECRU'/VERDE ACQUA/CROMO
 ECRU/AQUA GREEN/CHROME

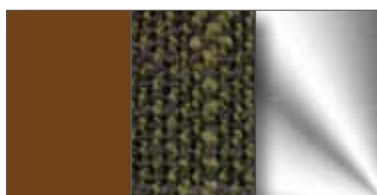

921
 MATTONE/VERDE/CROMO
 BRICK RED/GREEN/CHROME

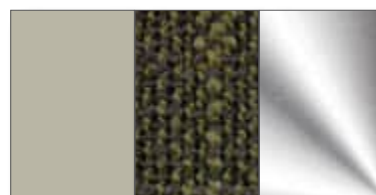

993
 ECRU'/VERDE/CROMO
 ECRU/GREEN/CHROME

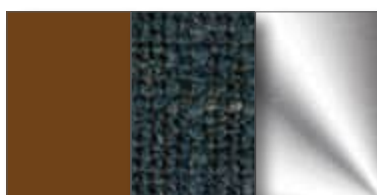

865
 MATTONE/BLU CHIARO/CROMO
 BRICK RED/LIGHT BLUE/CHROME

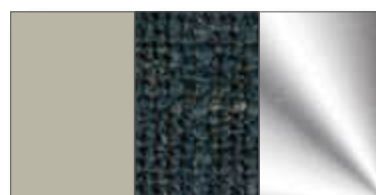

937
 ECRU'/BLU CHIARO/CROMO
 ECRU/LIGHT BLUE/CHROME

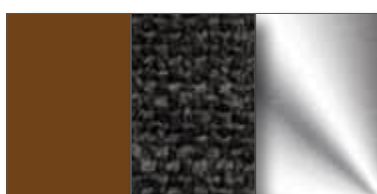

891
 MATTONE/GRIGIO SCURO/CROMO
 BRICK RED/DARK GREY/CHROME

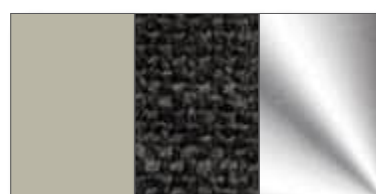

963
 ECRU'/GRIGIO SCURO/CROMO
 ECRU/DARK GREY/CHROME

CAT.B

764 PU RIGIDO VERNICIATO/MISTO POLIESTERE BERLINO/ACCIAIO CROMATO
STIFF PAINTED PU/POLYESTER MIX BERLINO/CHROMED STEEL

Moon



A03
NERO/AVORIO/CROMO
BLACK/IVORY/CHROME

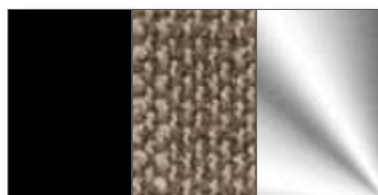

A61
NERO/SABBIA/CROMO
BLACK/SAND/CHROME

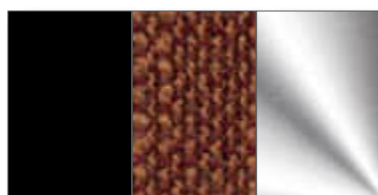

H58
NERO/ARANCIO/CROMO
BLACK/ORANGE/CHROME

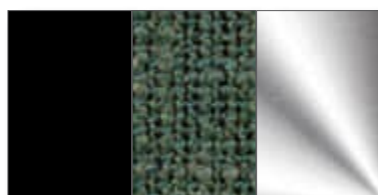

H17
NERO/VERDE ACQUA/CROMO
BLACK/AQUA GREEN/CHROME

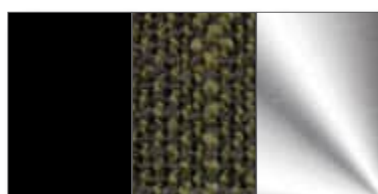

A65
NERO/VERDE/CROMO
BLACK/GREEN/CHROME

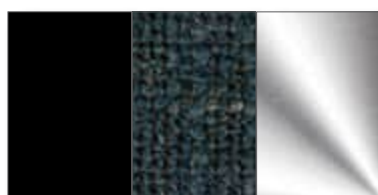

A09
NERO/BLU CHIARO/CROMO
BLACK/LIGHT BLUE/CHROME

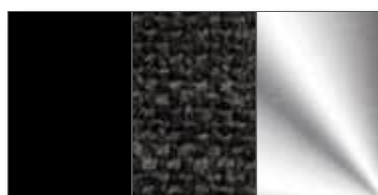

A35
NERO/GRIGIO SCURO/CROMO
BLACK/DARK GREY/CHROME

CAT.B

872 MISTO POLIESTERE BERLINO/ACCIAIO CROMATO
 POLYESTER MIX BERLINO/CHROMED STEEL

Cocky



C36
 AVORIO/CROMO
 IVORY/CHROME

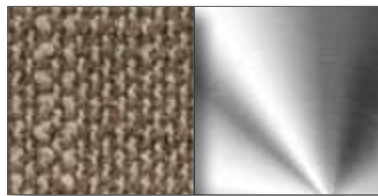

C59
 SABBIA/CROMO
 SAND/CHROME

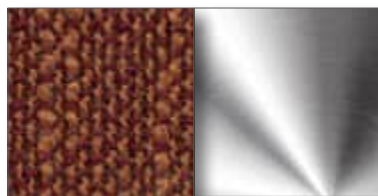

H60
 ARANCIO/CROMO
 ORANGE/CHROME

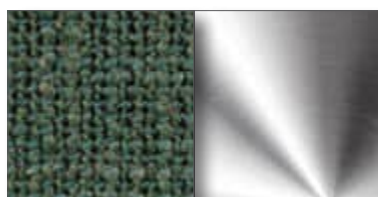

H30
 VERDE ACQUA/CROMO
 AQUA GREEN/CHROME



H26
 VERDE/CROMO
 GREEN/CHROME



H59
 BLU CHIARO/CROMO
 LIGHT BLUE/CHROME

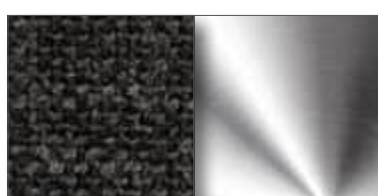

C47
 GRIGIO SCURO/CROMO
 DARK GREY/CHROME

CAT.B

705 POLIESTERE JAKARTA - POLYESTER JAKARTA

Composizione/Composition: 100% PL riciclato biodegradabile/PL recycled biodegradable. Altezza/Height: 140 cm. Peso/Weight: 800gr. Abrasione/Abrasion: 100.000 Martindale (uso pubblico, uso molto intensivo/public use, very intensive use).

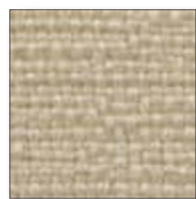

004
AVORIO
IVORY



016
TORTORA
TAUPE

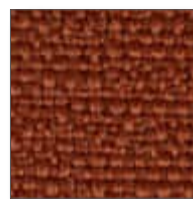

033
ARANCIO
ORANGE

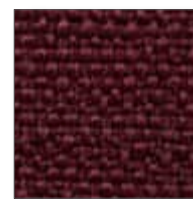

040
BORDEAUX
BURGUNDY



070
BLU CHIARO
LIGHT BLUE



066
VERDE SCURO
DARK GREEN



083
MARRONE SCURO
DARK BROWN



041
GRIGIO GHIACCIO
ICE GREY



050
GRIGIO SCURO
DARK GREY

I colori sono indicativi. Non è possibile garantire uniformità di tono nella tintura dei lotti di tessuto. Resta inteso che lievi differenze di colore verranno accettate al momento dell'ordine.

The colors are just indicative. Actually a steady tone of lots cannot be guaranteed. It remains understood that any slight colour difference will be accepted in case an order is placed.

CAT.B

765 POLIESTERE JAKARTA/FRASSINO - *POLYESTER JAKARTA/ASH*

La Francesa

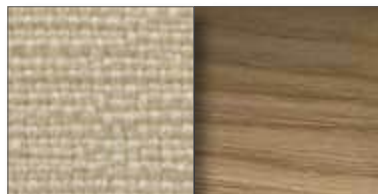

172
AVORIO/NATURALE
IVORY/NATURAL

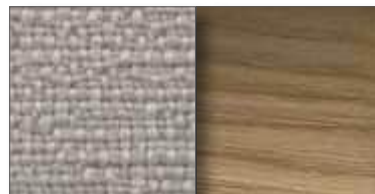

198
GRIGIO GHIACCIO/NATURALE
ICE GREY/NATURAL

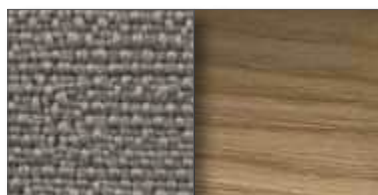

224
TORTORA/NATURALE
TAUPE/NATURAL

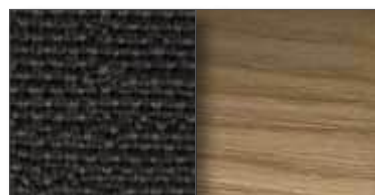

191
GRIGIO SCURO/NATURALE
DARK GREY/NATURAL

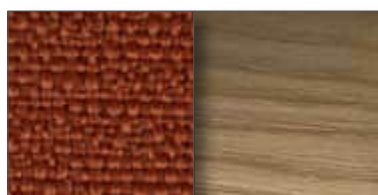

H47
ARANCIO/NATURALE
ORANGE/NATURAL

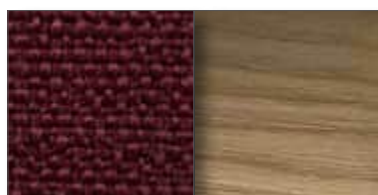

183
BORDEAUX/NATURALE
BURGUNDY/NATURAL



178
BLU CHIARO/NATURALE
LIGHT BLUE/NATURAL



227
VERDE SCURO/NATURALE
DARK GREEN/NATURAL

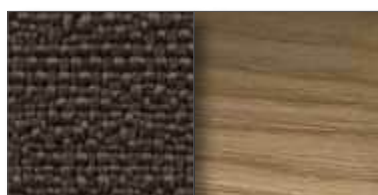

203
MARRONE SCURO/NATURALE
DARK BROWN/NATURAL

CAT.B

765 POLIESTERE JAKARTA/FRASSINO - *POLYESTER JAKARTA/ASH*

La Francesea

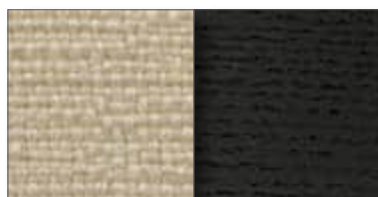

233
AVORIO/EBANIZZATO
IVORY/EBONIZED



257
GRIGIO GHIACCIO/EBANIZZATO
ICE GREY/EBONIZED



286
TORTORA/EBANIZZATO
TAUPE/EBONIZED



260
GRIGIO SCURO/EBANIZZATO
DARK GREY/EBONIZED

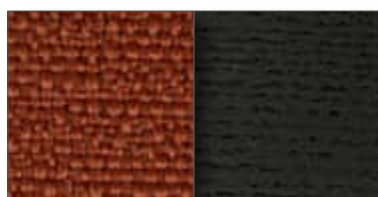

H48
ARANCIO/EBANIZZATO
ORANGE/EBONIZED

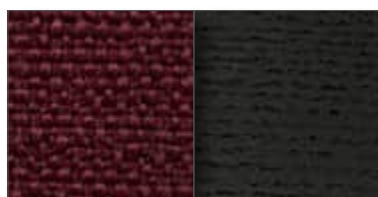

243
BORDEAUX/EBANIZZATO
BURGUNDY/EBONIZED



238
BLU CHIARO/EBANIZZATO
LIGHT BLUE/EBONIZED



289
VERDE SCURO/EBANIZZATO
DARK GREEN/EBONIZED

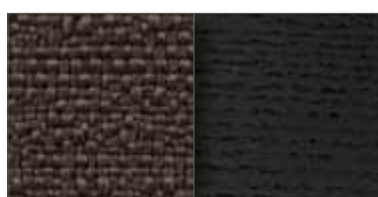

265
MARRONE SCURO/EBANIZZATO
DARK BROWN/EBONIZED

CAT.B

767 POLIESTERE JAKARTA/ACCIAIO VERNICIATO - *POLYESTER JAKARTA/PAINTED STEEL*

33 Cuscini

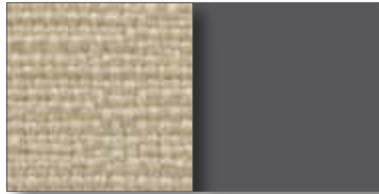

322
AVORIO/GRAFITE
IVORY/GRAPHITE

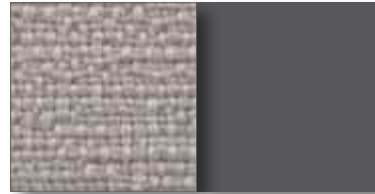

349
GRIGIO GHIACCIO/GRAFITE
ICE GREY/GRAPHITE

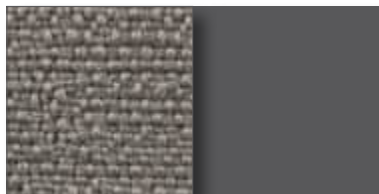

378
TORTORA/GRAFITE
TAUPE/GRAPHITE

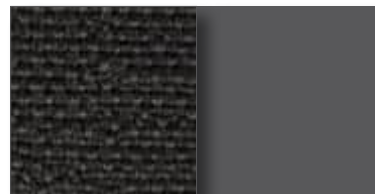

353
GRIGIO SCURO/GRAFITE
DARK GREY/GRAPHITE

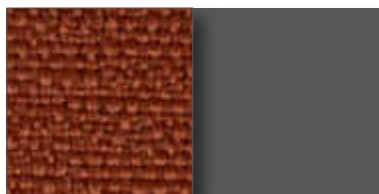

320
ARANCIO/GRAFITE
ORANGE/GRAPHITE

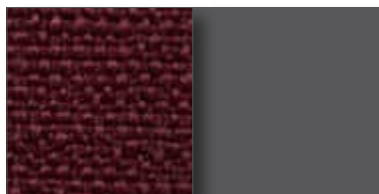

337
BORDEAUX/GRAFITE
BORDEAUX/GRAPHITE

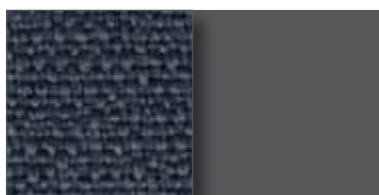

330
BLU CHIARO/GRAFITE
LIGHT BLUE/GRAPHITE



384
VERDE SCURO/GRAFITE
DARK GREEN/GRAPHITE

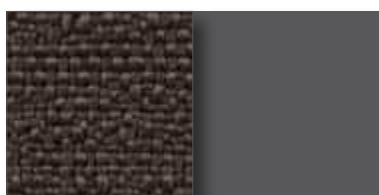

359
MARRONE SCURO/GRAFITE
DARK BROWN/GRAPHITE

CAT.B

767 POLIESTERE JAKARTA/ACCIAIO VERNICIATO - *POLYESTER JAKARTA/PAINTED STEEL*

Elisa

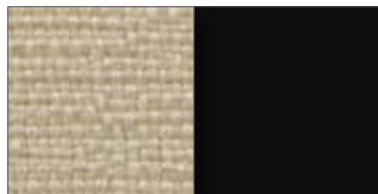

388
 AVORIO/NERO MARRONE
IVORY/BLACK BROWN

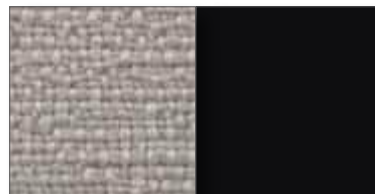

408
 GRIGIO GHIACCIO/NERO MARRONE
ICE GREY/BLACK BROWN

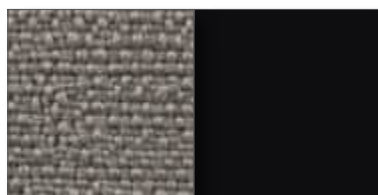

427
 TORTORA/NERO MARRONE
TAUPE/BLACK BROWN

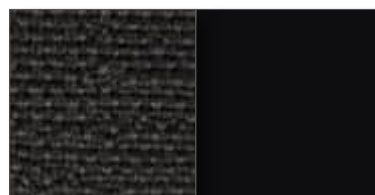

411
 GRIGIO SCURO/NERO MARRONE
DARK GREY/BLACK BROWN

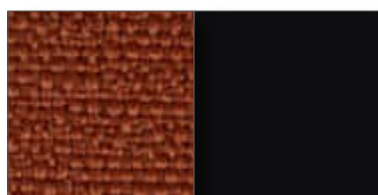

387
 ARANCIO/NERO MARRONE
ORANGE/BLACK BROWN

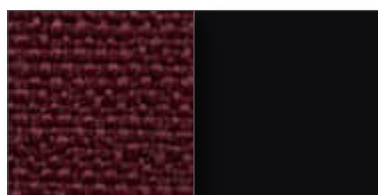

401
 BORDEAUX/NERO MARRONE
BORDEAUX/BLACK BROWN

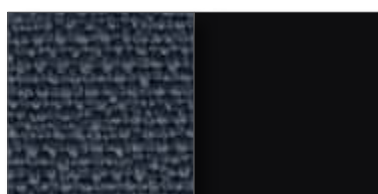

394
 BLU CHIARO/NERO MARRONE
LIGHT BLUE/BLACK BROWN

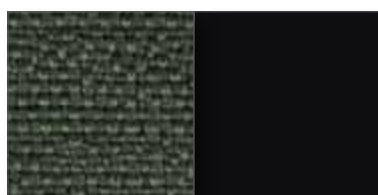

432
 VERDE SCURO/NERO MARRONE
DARK GREEN/BLACK BROWN

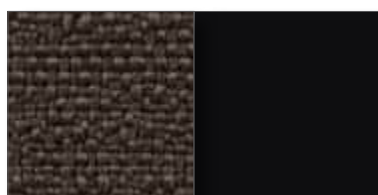

415
 MARRONE SCURO/NERO MARRONE
DARK BROWN/BLACK BROWN

CAT.B

767 POLIESTERE JAKARTA/ACCIAIO VERNICIATO - *POLYESTER JAKARTA/PAINTED STEEL*

Fenix



436
AVORIO/PELTRO BRONZATO
IVORY|BRONZE PEWTER



467
GRIGIO GHIACCIO/PELTRO BRONZATO
ICE GREY|BRONZE PEWTER



501
TORTORA/PELTRO BRONZATO
TAUPE|BRONZE PEWTER



471
GRIGIO SCURO/PELTRO BRONZATO
DARK GREY|BRONZE PEWTER



H51
ARANCIO/PELTRO BRONZATO
ORANGE|BRONZE PEWTER

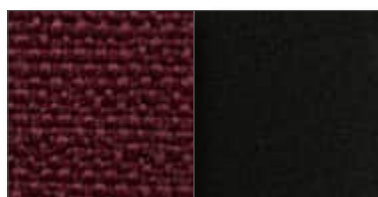

451
BORDEAUX/PELTRO BRONZATO
BURGUNDY|BRONZE PEWTER



444
BLU CHIARO/PELTRO BRONZATO
LIGHT BLUE|BRONZE PEWTER

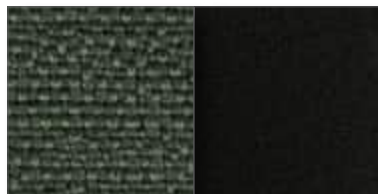

507
VERDE SCURO/PELTRO BRONZATO
DARK GREEN|BRONZE PEWTER



477
MARRONE SCURO/PELTRO BRONZATO
DARK BROWN|BRONZE PEWTER

CAT.B

767 POLIESTERE JAKARTA/ACCIAIO VERNICIATO - *POLYESTER JAKARTA/PAINTED STEEL*

Cocky



590
 AVORIO/NERO
IVORY/BLACK

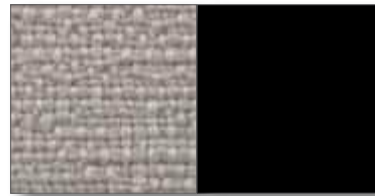

621
 GRIGIO GHIACCIO/NERO
ICE GREY/BLACK

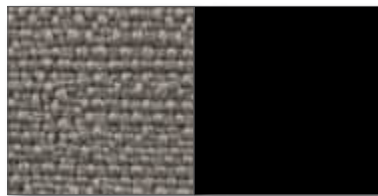

655
 TORTORA/NERO
TAUPE/BLACK

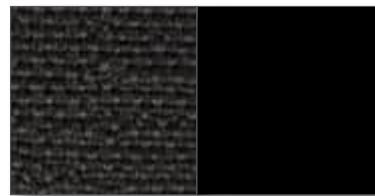

625
 GRIGIO SCURO/NERO
DARK GREY/BLACK

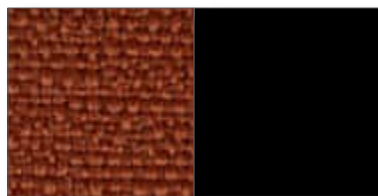

H53
 ARANCIO/NERO
ORANGE/BLACK

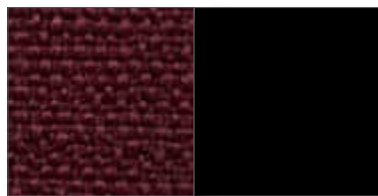

605
 BORDEAUX/NERO
BURGUNDY/BLACK



598
 BLU CHIARO/NERO
LIGHT BLUE/BLACK



661
 VERDE SCURO/NERO
DARK GREEN/BLACK

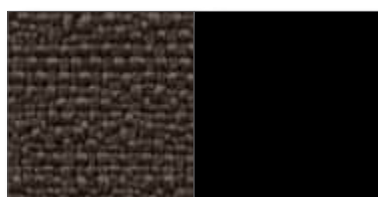

630
 MARRONE SCURO/NERO
DARK BROWN/BLACK

CAT.B

768 POLIESTERE JAKARTA/ALLUMINIO LUCIDATO - *POLYESTER JAKARTA/POLISHED ALUMINUM*

Cocky

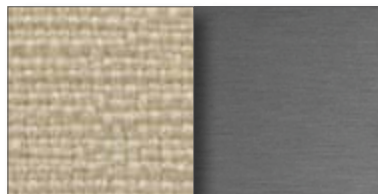

526
AVORIO/ALLUMINIO
IVORY/ALUMINUM

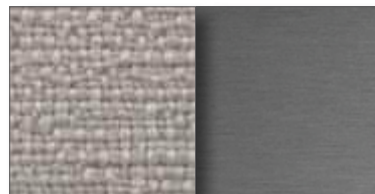

551
GRIGIO GHIACCIO/ALLUMINIO
ICE GREY/ALUMINUM

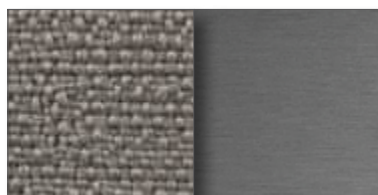

582
TORTORA/ALLUMINIO
TAUPE/ALUMINUM

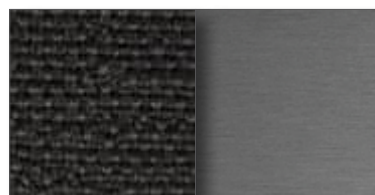

554
GRIGIO SCURO/ALLUMINIO
DARK GREY/ALUMINUM

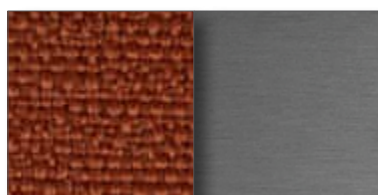

H54
ARANCIO/ALLUMINIO
ORANGE/ALUMINUM

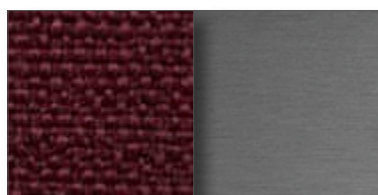

537
BORDEAUX/ALLUMINIO
BURGUNDY/ALUMINUM

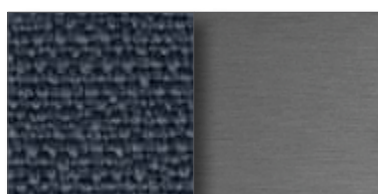

532
BLU CHIARO/ALLUMINIO
LIGHT BLUE/ALUMINUM

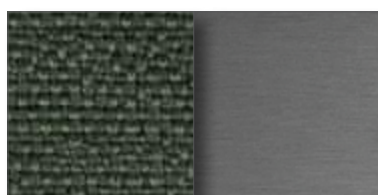

585
VERDE SCURO/ALLUMINIO
DARK GREEN/ALUMINUM

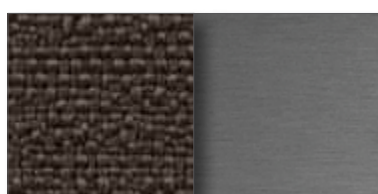

559
MARRONE SCURO/ALLUMINIO
DARK BROWN/ALUMINUM

CAT.B

769 POLIESTERE JAKARTA/ALLUMINIO VERNICIATO - *POLYESTER JAKARTA/PAINTED ALUMINUM*

Lirica, Lirico

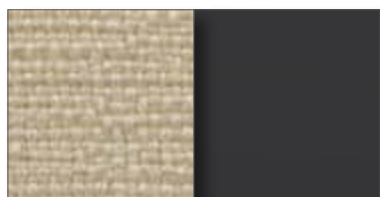

590
AVORIO/NERO
IVORY/BLACK

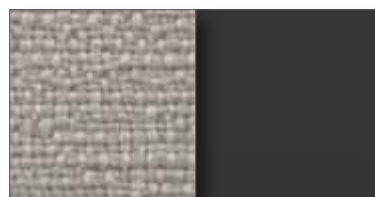

621
GRIGIO GHIACCIO/NERO
ICE GREY/BLACK

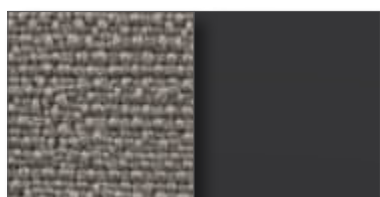

655
TORTORA/NERO
TAUPE/BLACK

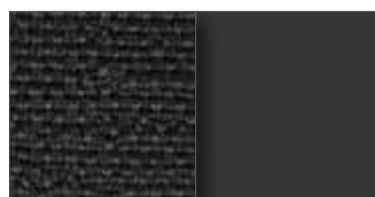

625
GRIGIO SCURO/NERO
DARK GREY/BLACK

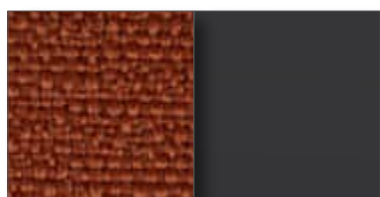

H53
ARANCIO/NERO
ORANGE/BLACK

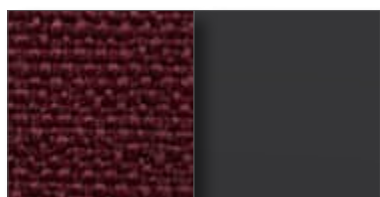

605
BORDEAUX/NERO
BURGUNDY/BLACK

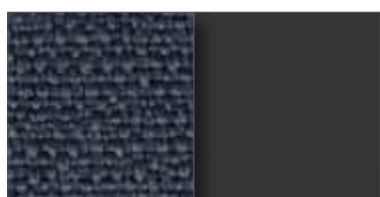

598
BLU CHIARO/NERO
LIGHT BLUE/BLACK

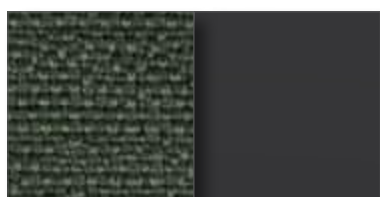

661
VERDE SCURO/NERO
DARK GREEN/BLACK

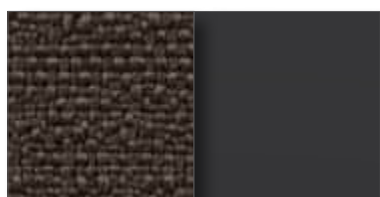

630
MARRONE SCURO/NERO
DARK BROWN/BLACK

CAT.B

769 POLIESTERE JAKARTA/ALLUMINIO VERNICIATO - *POLYESTER JAKARTA/PAINTED ALUMINUM*

Lirica, Lirico



716
AVORIO/ARGENTO
IVORY/SILVER



747
GRIGIO GHIACCIO/ARGENTO
ICE GREY/SILVER



782
TORTORA/ARGENTO
TAUPE/SILVER



751
GRIGIO SCURO/ARGENTO
DARK GREY/SILVER



H55
ARANCIO/ARGENTO
ORANGE/SILVER



731
BORDEAUX/ARGENTO
BURGUNDY/SILVER



724
BLU CHIARO/ARGENTO
LIGHT BLUE/SILVER



788
VERDE SCURO/ARGENTO
DARK GREEN/SILVER



757
MARRONE SCURO/ARGENTO
DARK BROWN/SILVER

CAT.B

772 POLIESTERE JAKARTA/FAGGIO LACCATO - POLYESTER JAKARTA/LACQUERED BEECH

S.Marco, S.Marco Lounge

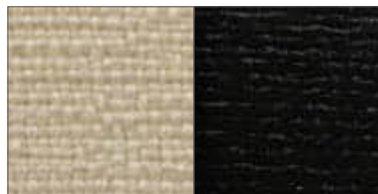

590
AVORIO/NERO
IVORY/BLACK

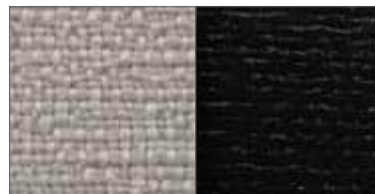

621
GRIGIO GHIACCIO/NERO
ICE GREY/BLACK



655
TORTORA/NERO
TAUPE/BLACK



625
GRIGIO SCURO/NERO
DARK GREY/BLACK



H53
ARANCIO/NERO
ORANGE/BLACK

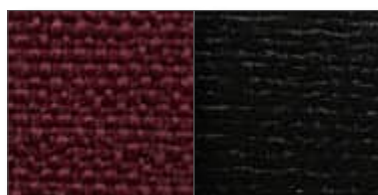

605
BORDEAUX/NERO
BURGUNDY/BLACK



598
BLU CHIARO/NERO
LIGHT BLUE/BLACK



661
VERDE SCURO/NERO
DARK GREEN/BLACK

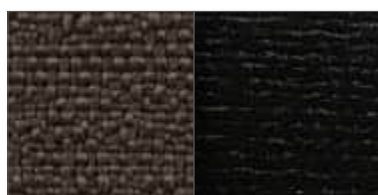

630
MARRONE SCURO/NERO
DARK BROWN/BLACK

CAT.B

773 PU RIGIDO VERNICIATO/POLIESTERE JAKARTA/ACCIAIO CROMATO
 STIFF PAINTED PU/POLYESTER JAKARTA/CHROMED STEEL

Moon

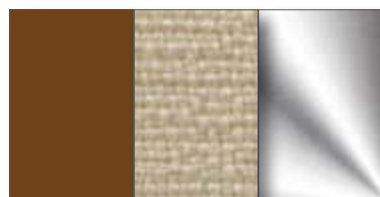

859
 MATTONE/AVORIO/CROMO
 BRICK RED/IVORY/CHROME

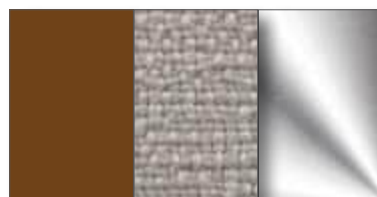

887
 MATTONE/GRIGIO GHIACCIO/CROMO
 BRICK RED/ICE GREY/CHROME

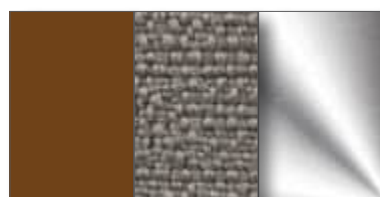

920
 MATTONE/TORTORA/CROMO
 BRICK RED/TAUPE/CHROME

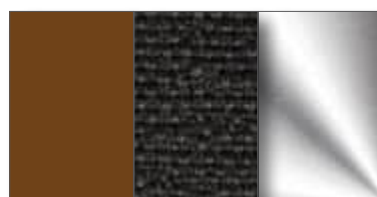

891
 MATTONE/GRIGIO SCURO/CROMO
 BRICK RED/DARK GREY/CHROME

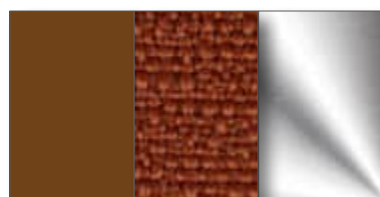

H56
 MATTONE/ARANCIO/CROMO
 BRICK RED/ARANCIO/CHROME

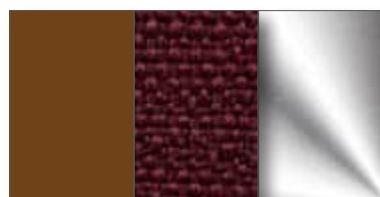

872
 MATTONE/BORDEAUX/CROMO
 BRICK RED/BURGUNDY/CHROME

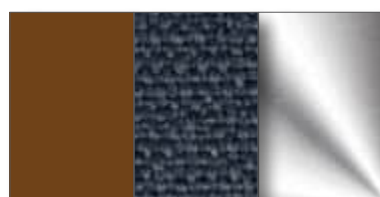

865
 MATTONE/BLU CHIARO/CROMO
 BRICK RED/LIGHT BLUE/CHROME

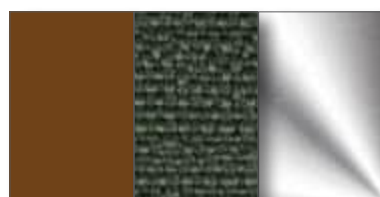

926
 MATTONE/VERDE SCURO/CROMO
 BRICK RED/DARK GREEN/CHROME

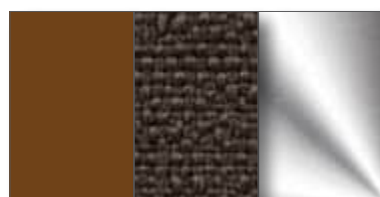

897
 MATTONE/MARRONE SCURO/CROMO
 BRICK RED/DARK BROWN/CHROME

CAT.B

773 PU RIGIDO VERNICIATO/POLIESTERE JAKARTA/ACCIAIO CROMATO
STIFF PAINTED PU/POLYESTER JAKARTA/CHROMED STEEL

Moon



931
ECRU/AVORIO/CROMO
ECRU/IVORY/CHROME

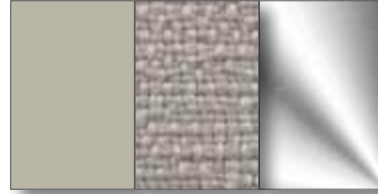

959
ECRU/GRIGIO GHIACCIO/CROMO
ECRU/ICE GREY/CHROME

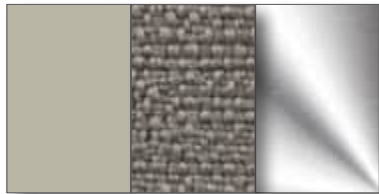

992
ECRU/TORTORA/CROMO
ECRU/TAUPE/CHROME

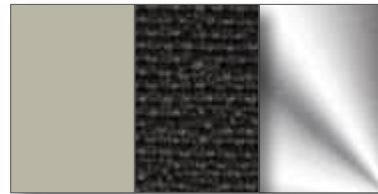

963
ECRU/GRIGIO SCURO/CROMO
ECRU/DARK GREY/CHROME

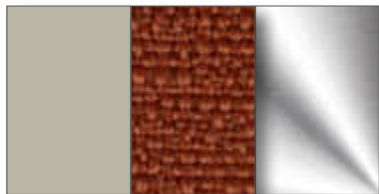

H57
ECRU/ARANCIO/CROMO
ECRU/ORANGE/CHROME

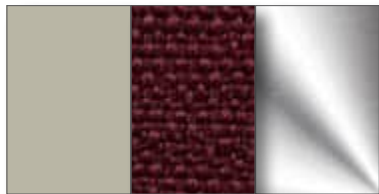

944
ECRU/BORDEAUX/CROMO
ECRU/BURGUNDY/CHROME

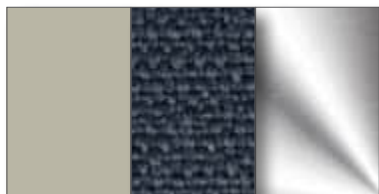

937
ECRU/BLU CHIARO/CROMO
ECRU/LIGHT BLUE/CHROME

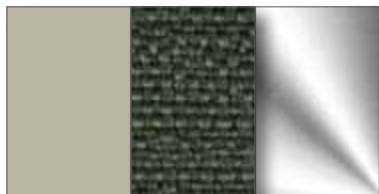

998
ECRU/VERDE SCURO/CROMO
ECRU/DARK GREEN/CHROME

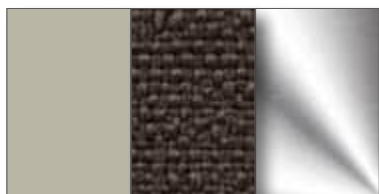

969
ECRU/MARRONE SCURO/CROMO
ECRU/DARK BROWN/CHROME

CAT.B

773 PU RIGIDO VERNICIATO/POLIESTERE JAKARTA/ACCIAIO CROMATO
 STIFF PAINTED PU/POLYESTER JAKARTA/CHROMED STEEL

Moon

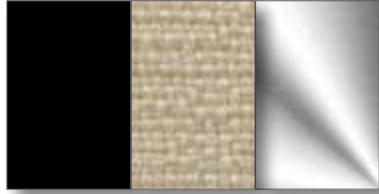

A03
 NERO/AVORIO/CROMO
 BLACK/IVORY/CHROME

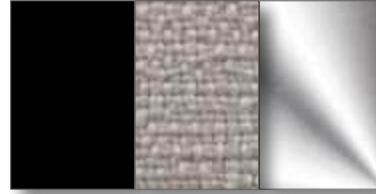

A31
 NERO/GRIGIO GHIACCIO/CROMO
 BLACK/ICE GREY/CHROME

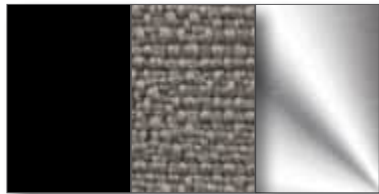

A64
 NERO/TORTORA/CROMO
 BLACK/TAUPE/CHROME

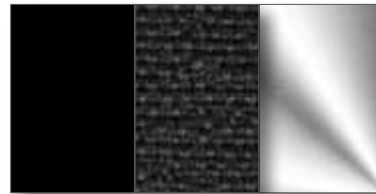

A35
 NERO/GRIGIO SCURO/CROMO
 BLACK/DARK GREY/CHROME

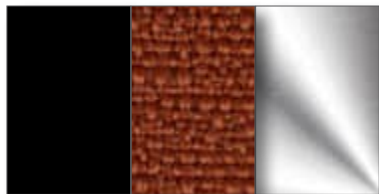

H58
 NERO/ARANCIO/CROMO
 BLACK/ORANGE/CHROME

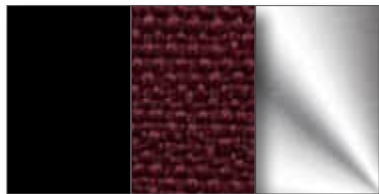

A16
 NERO/BORDEAUX/CROMO
 BLACK/BURGUNDY/CHROME

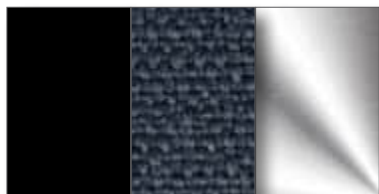

A09
 NERO/BLU CHIARO/CROMO
 BLACK/LIGHT BLUE/CHROME

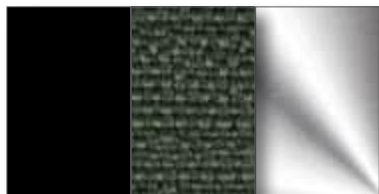

A70
 NERO/VERDE SCURO/CROMO
 BLACK/DARK GREEN/CHROME

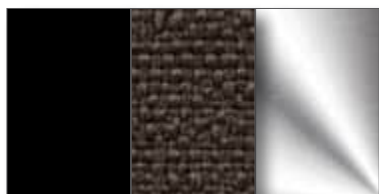

A41
 NERO/MARRONE SCURO/CROMO
 BLACK/DARK BROWN/CHROME

CAT.B

868 POLIESTERE JAKARTA/ACCIAIO CROMATO
 POLYESTER JAKARTA/CHROMED STEEL

Cocky



C36
 AVORIO/CROMO
 IVORY/CHROME

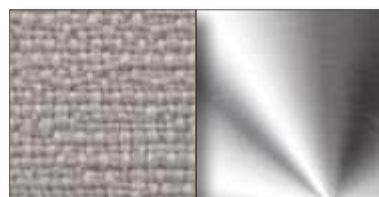

H61
 GRIGIO GHIACCIO/CROMO
 ICE GREY/CHROME

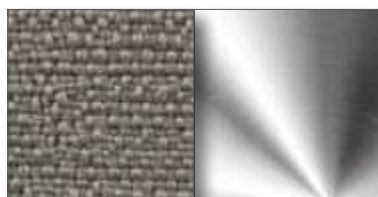

E86
 TORTORA/CROMO
 TAUPE/CHROME

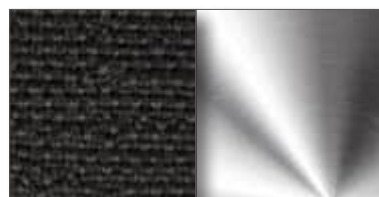

C47
 GRIGIO SCURO/CROMO
 DARK GREY/CHROME

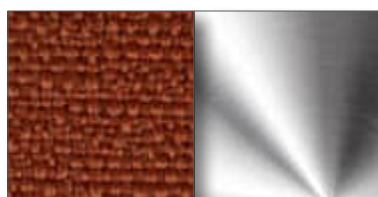

H60
 ARANCIO/CROMO
 ORANGE/CHROME

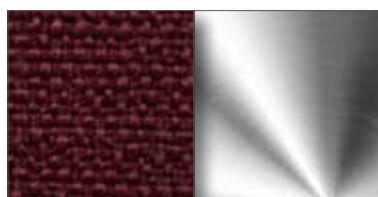

C41
 BORDEAUX/CROMO
 BURGUNDY/CHROME

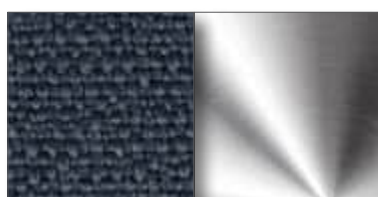

H59
 BLU CHIARO/CROMO
 LIGHT BLUE/CHROME

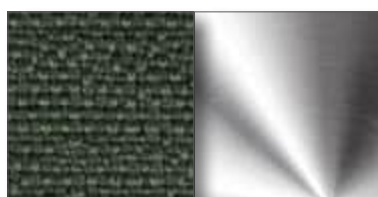

C63
 VERDE SCURO/CROMO
 DARK GREEN/CHROME

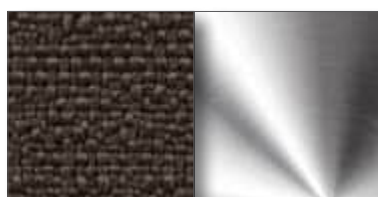

C53
 MARRONE SCURO/CROMO
 DARK BROWN/CHROME

CAT.B

706 POLIESTERE GINEVRA - *POLYESTER GINEVRA*

Composizione/Composition: 100% PL. Altezza/Height: 140 cm. Peso/Weight: 460gr. Abrasione/Abrasion: 25.000 Martindale (uso pubblico, uso regolare/public use, regular use).



004
AVORIO
IVORY



011
SABBIA
SAND



016
TORTORA
TAUPE



H19
ROSA CHIARO
LIGHT PINK

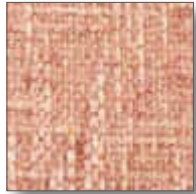

H20
ROSA SCURO
DARK PINK



040
BORDEAUX
BURGUNDY



060
AZZURRO
LIGHT BLUE



069
PETROLIO
PETROL GREEN



071
BLU MEDIO
MEDIUM BLUE



073
BLU SCURO
DARK BLUE

I colori sono indicativi. Non è possibile garantire uniformità di tono nella tintura dei lotti di tessuto. Resta inteso che lievi differenze di colore verranno accettate al momento dell'ordine.

The colors are just indicative. Actually a steady tone of lots cannot be guaranteed. It remains understood that any slight colour difference will be accepted in case an order is placed.

CAT.B

776 POLIESTERE GINEVRA/ACCIAIO VERNICIATO - *POLYESTER GINEVRA/PAINTED STEEL*

Sof Sof, 33 Cuscini



322
AVORIO/GRAFITE
IVORY/GRAPHITE

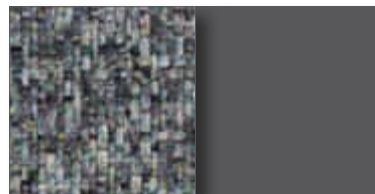

367
PETROLIO/GRAFITE
PETROL GREEN/GRAPHITE

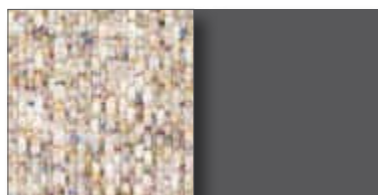

377
SABBIA/GRAFITE
SAND/GRAPHITE

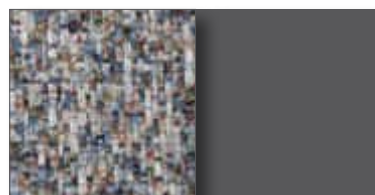

333
BLU MEDIO/GRAFITE
MEDIUM BLUE/GRAPHITE



378
TORTORA/GRAFITE
TAUPE/GRAPHITE



334
BLU SCURO/GRAFITE
DARK BLUE/GRAPHITE

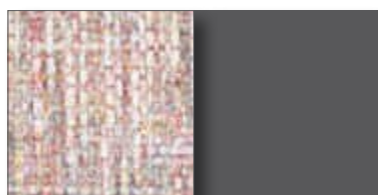

H62
ROSA CHIARO/GRAFITE
LIGHT PINK/GRAPHITE

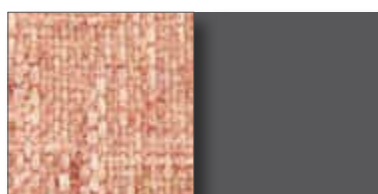

H63
ROSA SCURO/GRAFITE
DRK PINK/GRAPHITE

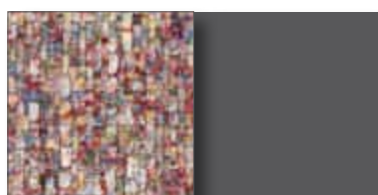

337
BORDEAUX/GRAFITE
BORDEAUX/GRAPHITE



326
AZZURRO/GRAFITE
LIGHT BLUE/GRAPHITE

CAT.B

776 POLIESTERE GINEVRA/ACCIAIO VERNICIATO - POLYESTER GINEVRA/PAINTED STEEL

Elisa

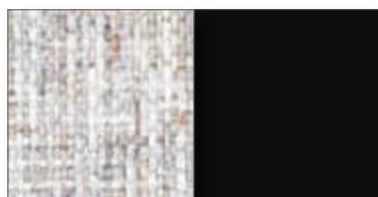

388
AVORIO/NERO MARRONE
IVORY/BLACK BROWN

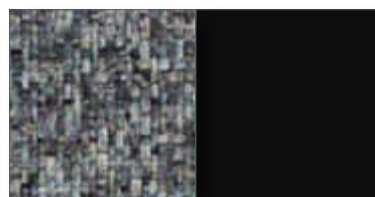

419
PETROLIO/NERO MARRONE
PETROL GREEN/BLACK BROWN

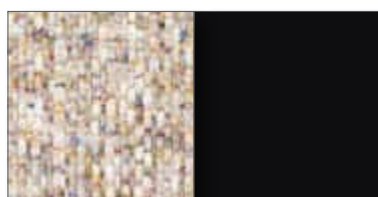

426
SABBIA/NERO MARRONE
SAND/BLACK BROWN

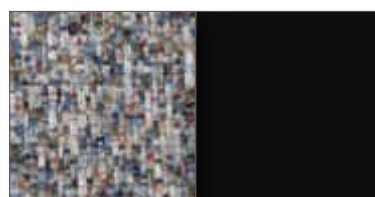

397
BLU MEDIO/NERO MARRONE
MEDIUM BLUE/BLACK BROWN



427
TORTORA/NERO MARRONE
TAUPE/BLACK BROWN



398
BLU SCURO/NERO MARRONE
DARK BLUE/BLACK BROWN

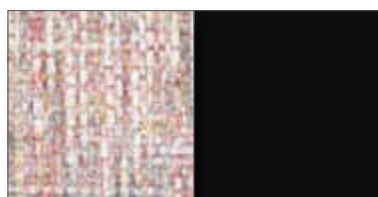

H64
ROSA CHIARO/NERO MARRONE
LIGHT PINK/BLACK BROWN

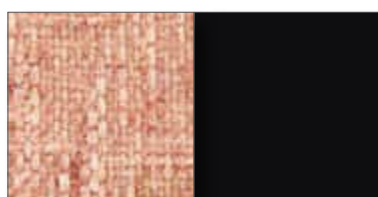

H65
ROSA SCURO/NERO MARRONE
DARK PINK/BLACK BROWN

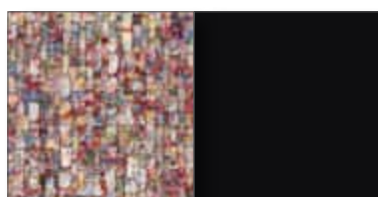

401
BORDEAUX/NERO MARRONE
BORDEAUX/BLACK BROWN

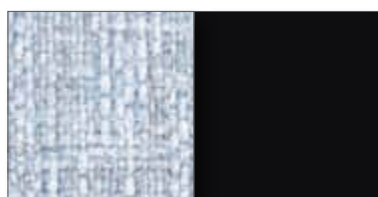

391
AZZURRO/NERO MARRONE
LIGHT BLUE/BLACK BROWN

CAT.B

776 POLIESTERE GINEVRA/ACCIAIO VERNICIATO - *POLYESTER GINEVRA/PAINTED STEEL*

Fenix



436
AVORIO/PELTRO BRONZATO
IVORY|BRONZE PEWTER

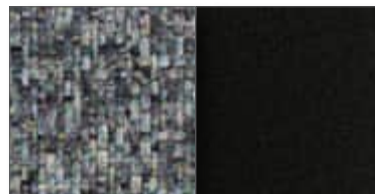

486
PETROLIO/PELTRO BRONZATO
PETROL GREEN|BRONZE PEWTER

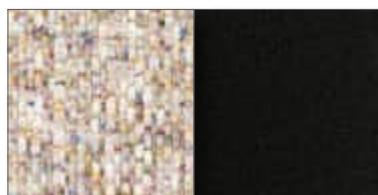

498
SABBIA/PELTRO BRONZATO
TAUPE|SAND PEWTER

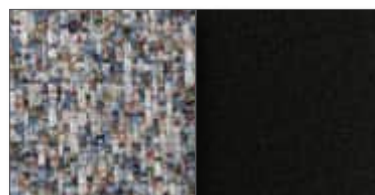

447
BLU MEDIO/PELTRO BRONZATO
MEDIUM BLUE|BRONZE PEWTER

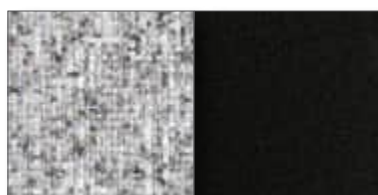

501
TORTORA/PELTRO BRONZATO
TAUPE|BRONZE PEWTER



448
BLU SCURO/PELTRO BRONZATO
DARK BLUE|BRONZE PEWTER



H66
ROSA CHIARO/PELTRO BRONZATO
LIGHT PINK|BRONZE PEWTER

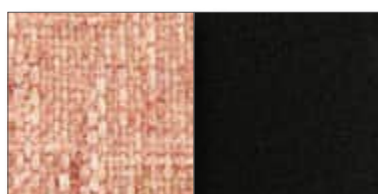

H67
ROSA SCURO/PELTRO BRONZATO
DARK PINK|BRONZE PEWTER

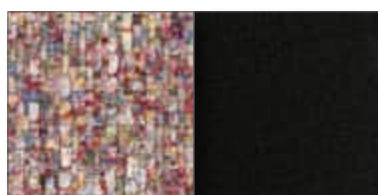

451
BORDEAUX/PELTRO BRONZATO
BURGUNDY|BRONZE PEWTER



440
AZZURRO/PELTRO BRONZATO
LIGHT BLUE|BRONZE PEWTER

CAT.B

776 POLIESTERE GINEVRA/ACCIAIO VERNICIATO - *POLYESTER GINEVRA/PAINTED STEEL*

Cocky



590
AVORIO/NERO
IVORY/BLACK

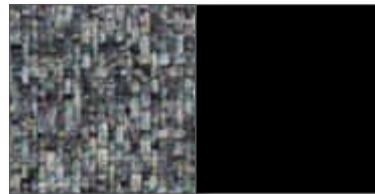

639
PETROLIO/NERO
PETROL GREEN/BLACK

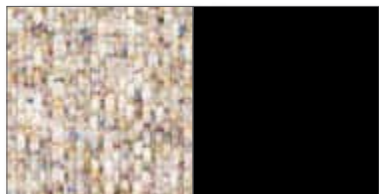

651
SABBIA/NERO
SAND/BLACK

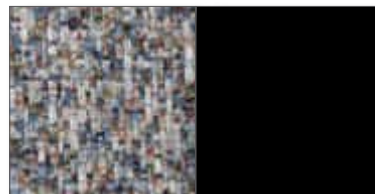

601
BLU MEDIO/NERO
MEDIUM BLUE/BLACK



655
TORTORA/NERO
TAUPE/BLACK



602
BLU SCURO/NERO
DARK BLUE/BLACK

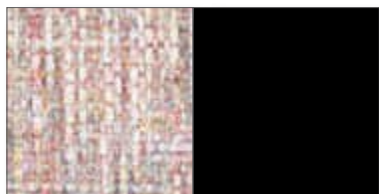

H70
ROSA CHIARO/NERO
LIGHT PINK/BLACK



H71
ROSA SCURO/NERO
DARK PINK/BLACK

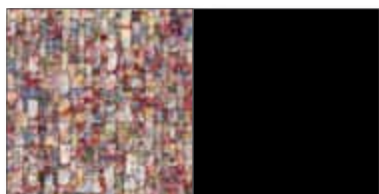

605
BORDEAUX/NERO
BURGUNDY/BLACK



594
AZZURRO/NERO
LIGHT BLUE/BLACK

CAT.B

777 POLIESTERE GINEVRA/ALLUMINIO LUCIDATO - POLYESTER GINEVRA/POLISHED ALUMINUM

Cocky

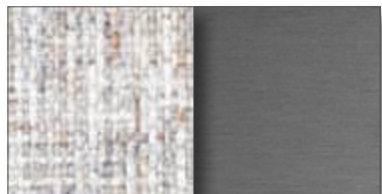

526
 AVORIO/ALLUMINIO
 IVORY/ALUMINUM

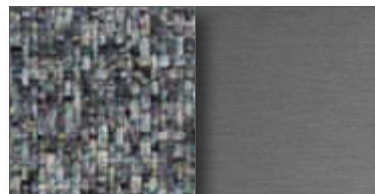

568
 PETROLIO/ALLUMINIO
 PETROL GREEN/ALUMINUM

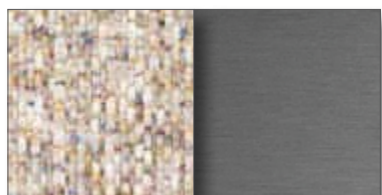

578
 SABBIA/ALLUMINIO
 SAND/ALUMINUM

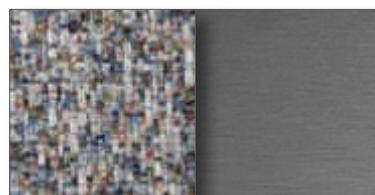

533
 BLU MEDIO/ALLUMINIO
 MEDIUM BLUE/ALUMINUM

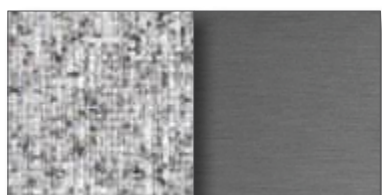

582
 TORTORA/ALLUMINIO
 TAUPE/ALUMINUM

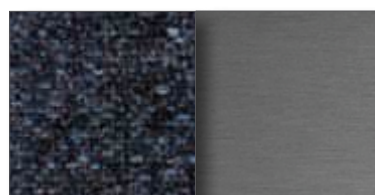

534
 BLU SCURO/ALLUMINIO
 DARK BLUE/ALUMINUM

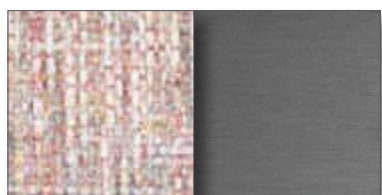

H72
 ROSA CHIARO/ALLUMINIO
 LIGHT PINK/ALUMINUM

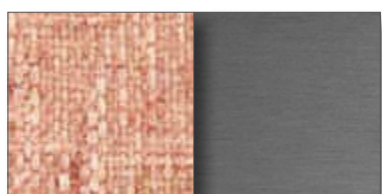

H73
 ROSA SCURO/ALLUMINIO
 DARK PINK/ALUMINUM

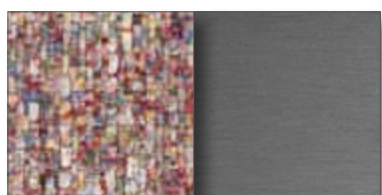

537
 BORDEAUX/ALLUMINIO
 BURGUNDY/ALUMINUM



529
 AZZURRO/ALLUMINIO
 LIGHT BLUE/ALUMINUM

CAT.B

778 POLIESTERE GINEVRA/ALLUMINIO VERNICIATO - *POLYESTER GINEVRA/PAINTED ALUMINUM*

Lirica, Lirico



590
AVORIO/NERO
IVORY/BLACK



639
PETROLIO/NERO
PETROL GREEN/BLACK

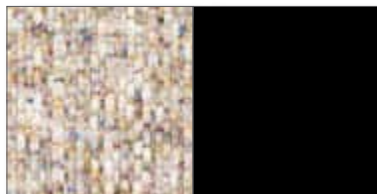

651
SABBIA/NERO
SAND/BLACK

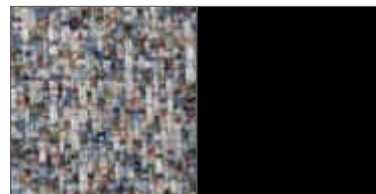

601
BLU MEDIO/NERO
MEDIUM BLUE/BLACK



655
TORTORA/NERO
TAUPE/BLACK



602
BLU SCURO/NERO
DARK BLUE/BLACK

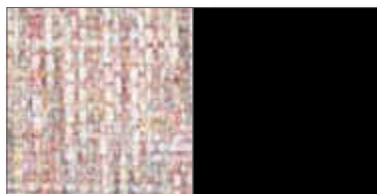

H70
ROSA CHIARO/NERO
LIGHT PINK/BLACK



H71
ROSA SCURO/NERO
DARK PINK/BLACK

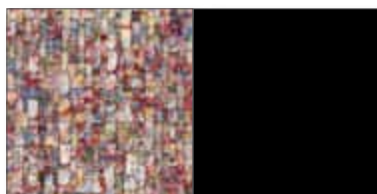

605
BORDEAUX/NERO
BURGUNDY/BLACK



594
AZZURRO/NERO
LIGHT BLUE/BLACK

CAT.B

778 POLIESTERE GINEVRA/ALLUMINIO VERNICIATO - *POLYESTER GINEVRA/PAINTED ALUMINUM*

Lirica, Lirico



716
AVORIO/ARGENTO
IVORY/SILVER



766
PETROLIO/ARGENTO
PETROL GREEN/SILVER



778
SABBIA/ARGENTO
SAND/SILVER

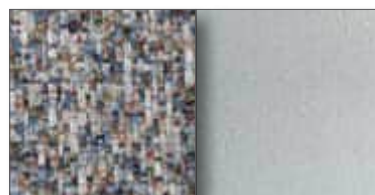

727
BLU MEDIO/ARGENTO
MEDIUM BLUE/SILVER



782
TORTORA/ARGENTO
TAUPE/SILVER



728
BLU SCURO/ARGENTO
DARK BLUE/SILVER



H74
ROSA CHIARO/ARGENTO
LIGHT PINK/SILVER



H75
ROSA SCURO/ARGENTO
DARK PINK/SILVER

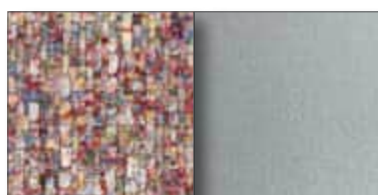

731
BORDEAUX/ARGENTO
BURGUNDY/SILVER



720
AZZURRO/ARGENTO
LIGHT BLUE/SILVER

CAT.B

781 POLIESTERE GINEVRA/FAGGIO LACCATO - *POLYESTER GINEVRA/LACQUERED BEECH*

S.Marco, S.Marco Lounge



590
AVORIO/NERO
IVORY/BLACK



639
PETROLIO/NERO
PETROL GREEN/BLACK

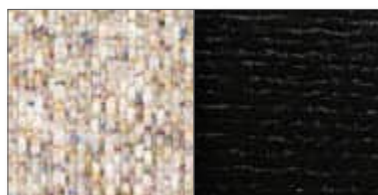

651
SABBIA/NERO
SAND/BLACK

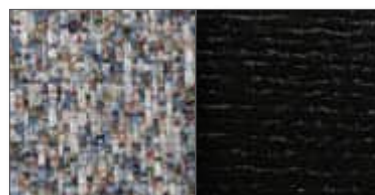

601
BLU MEDIO/NERO
MEDIUM BLUE/BLACK



655
TORTORA/NERO
TAUPE/BLACK



602
BLU SCURO/NERO
DARK BLUE/BLACK



H70
ROSA CHIARO/NERO
LIGHT PINK/BLACK

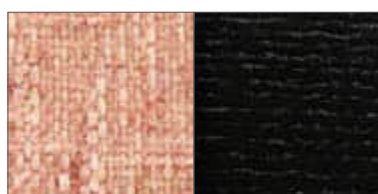

H71
ROSA SCURO/NERO
DARK PINK/BLACK

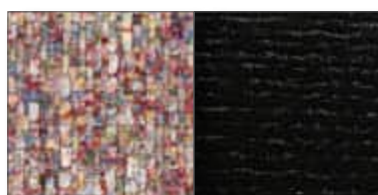

605
BORDEAUX/NERO
BURGUNDY/BLACK



594
AZZURRO/NERO
LIGHT BLUE/BLACK

CAT.B

782 PU RIGIDO VERNICIATO/POLIESTERE GINEVRA/ACCIAIO CROMATO
 STIFF PAINTED PU/POLYESTER GINEVRA/CHROMED STEEL

Moon

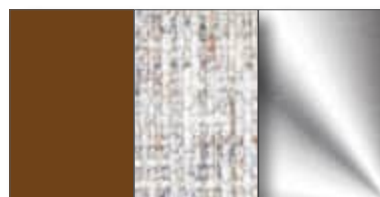

859
 MATTONE/AVORIO/CROMO
 BRICK RED/IVORY/CHROME

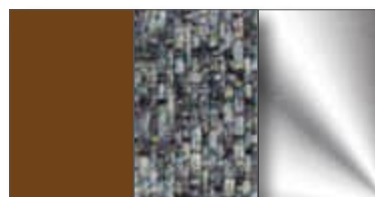

905
 MATTONE/PETROLIO/CROMO
 BRICK RED/PETROL GREEN/CHROME

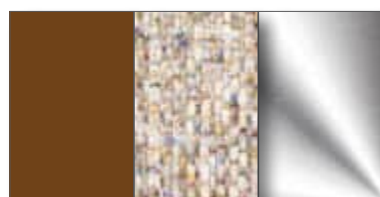

917
 MATTONE/SABBIA/CROMO
 BRICK RED/SAND/CHROME

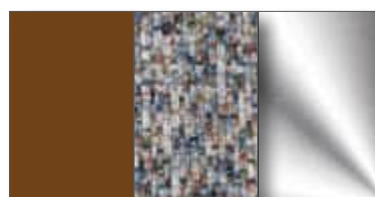

868
 MATTONE/BLU MEDIO/CROMO
 BRICK RED/MEDIUM BLUE/CHROME

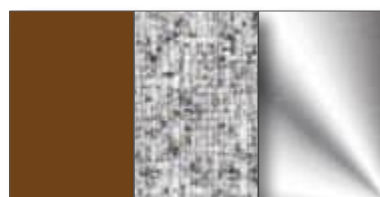

920
 MATTONE/TORTORA/CROMO
 BRICK RED/TAUPE/CHROME

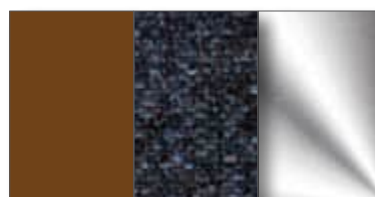

869
 MATTONE/BLU SCURO/CROMO
 BRICK RED/DARK BLUE/CHROME

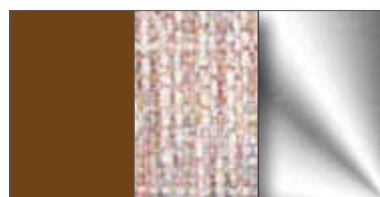

H83
 MATTONE/ROSA CHIARO/CROMO
 BRICK RED/LIGHT PINK/CHROME

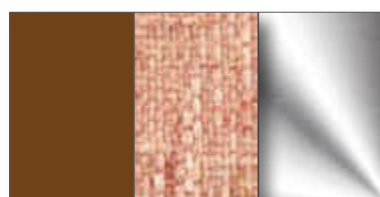

H84
 MATTONE/ROSA SCURO/CROMO
 BRICK RED/DARK PINK/CHROME

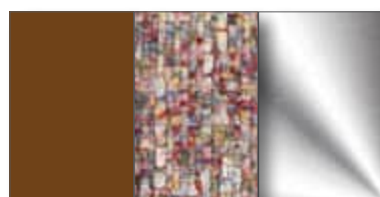

872
 MATTONE/BORDEAUX/CROMO
 BRICK RED/BURGUNDY/CHROME

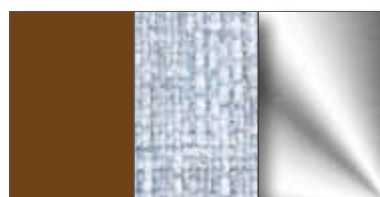

862
 MATTONE/AZZURRO/CROMO
 BRICK RED/LIGHT BLUE/CHROME

CAT.B

782 PU RIGIDO VERNICIATO/POLIESTERE GINEVRA/ACCIAIO CROMATO
STIFF PAINTED PU/POLYESTER GINEVRA/CHROMED STEEL

Moon

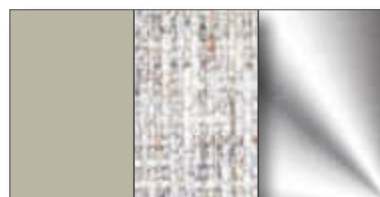

931
ECRU/AVORIO/CROMO
ECRU/IVORY/CHROME

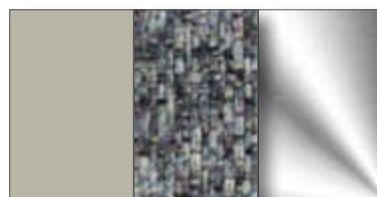

977
ECRU/PETROLIO/CROMO
ECRU/PETROL GREEN/CHROME

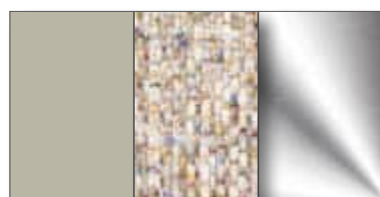

989
ECRU/SABBIA/CROMO
ECRU/SAND/CHROME

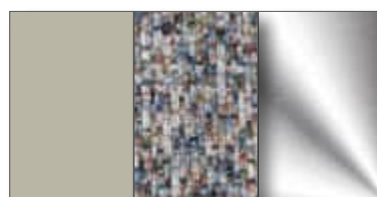

940
ECRU/BLU MEDIO/CROMO
ECRU/MEDIUM BLUE/CHROME



992
ECRU/TORTORA/CROMO
ECRU/TAUPE/CHROME

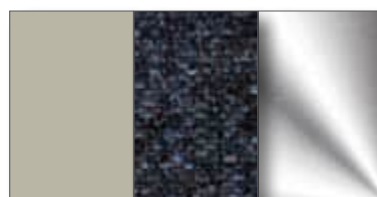

941
ECRU/BLU SCURO/CROMO
ECRU/DARK BLUE/CHROME

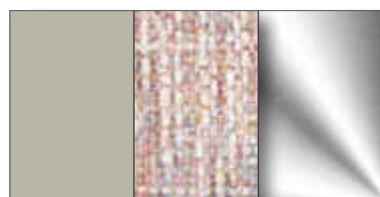

H85
ECRU/ROSA CHIARO/CROMO
ECRU/LIGHT PINK/CHROME



H86
ECRU/ROSA SCURO/CROMO
ECRU/DARK PINK/CHROME

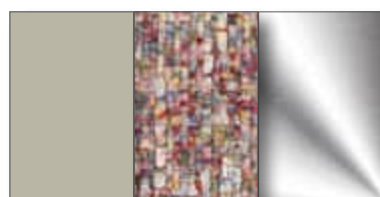

944
ECRU/BORDEAUX/CROMO
ECRU/BURGUNDY/CHROME



934
ECRU/AZZURRO/CROMO
ECRU/LIGHT BLUE/CHROME

CAT.B

782 PU RIGIDO VERNICIATO/POLIESTERE GINEVRA/ACCIAIO CROMATO
STIFF PAINTED PU/POLYESTER GINEVRA/CHROMED STEEL

Moon



A03
NERO/AVORIO/CROMO
BLACK/IVORY/CHROME

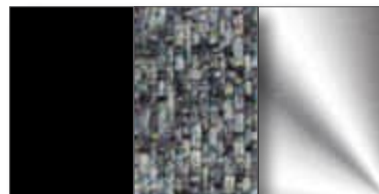

A49
NERO/PETROLIO/CROMO
BLACK/PETROL GREEN/CHROME

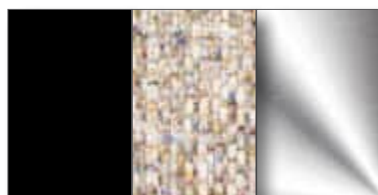

A61
NERO/SABBIA/CROMO
BLACK/SAND/CHROME

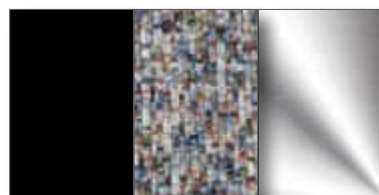

A12
NERO/BLU MEDIO/CROMO
BLACK/MEDIUM BLUE/CHROME



A64
NERO/TORTORA/CROMO
BLACK/TAUPE/CHROME

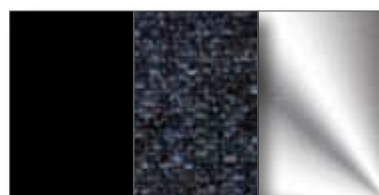

A13
NERO/BLU SCURO/CROMO
BLACK/DARK BLUE/CHROME



H87
NERO/ROSA CHIARO/CROMO
BLACK/LIGHT PINK/CHROME

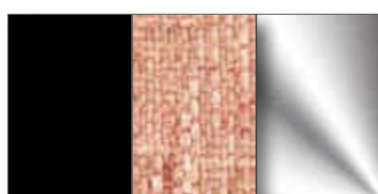

H88
NERO/ROSA SCURO/CROMO
BLACK/DARK PINK/CHROME

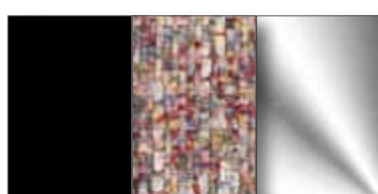

A16
NERO/BORDEAUX/CROMO
BLACK/BURGUNDY/CHROME



A06
NERO/AZZURRO/CROMO
BLACK/LIGHT BLUE/CHROME

CAT.B

874 POLIESTERE GINEVRA/ACCIAIO CROMATO
 POLYESTER GINEVRA/CHROMED STEEL

Cocky



C36
 AVORIO/CROMO
 IVORY/CHROME

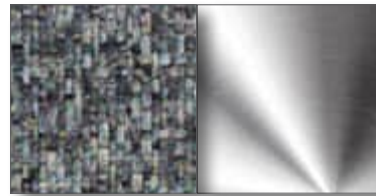

C56
 PETROLIO/CROMO
 PETROL GREEN/CHROME

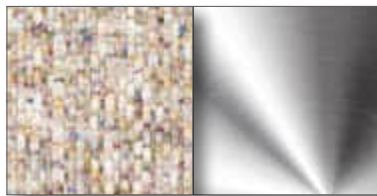

C59
 SABBIA/CROMO
 SAND/CHROME

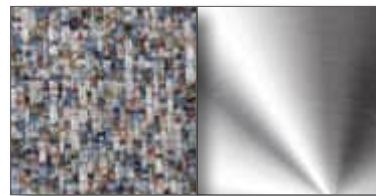

H89
 BLU MEDIO/CROMO
 MEDIUM BLUE/CHROME

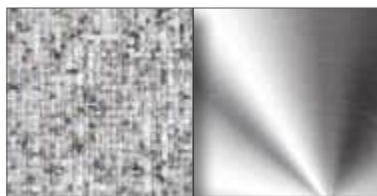

E86
 TORTORA/CROMO
 TAUPE/CHROME



F61
 BLU SCURO/CROMO
 DARK BLUE/CHROME



H91
 ROSA CHIARO/CROMO
 LIGHT PINK/CHROME



H92
 ROSA SCURO/CROMO
 DARK PINK/CHROME

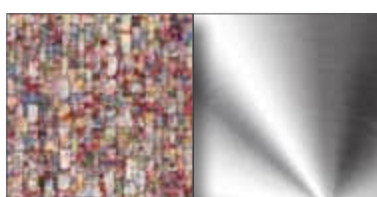

C41
 BORDEAUX/CROMO
 BURGUNDY/CHROME

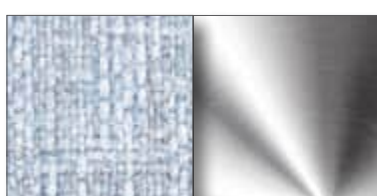

C37
 AZZURRO/CROMO
 LIGHT BLUE/CHROME

CAT.B

034 ACRILICO CIPRO - ACRYLIC CIPRO

Composizione/Composition: 100% PC. Altezza/Height: 140 cm. Peso/Weight: 270gr. Abrasione/Abrasion: 17.000 Martindale (uso personale, uso regolare/personal use, regular use).
 Antimacchia, idro e oleo repellente, con trattamento teflon antimuffa / Stain, hydro and oil repellent, with anti-mold teflon treatment.



002
BIANCO
WHITE



004
AVORIO
IVORY



011
SABBIA
SAND



024
ROSA
PINK



060
AZZURRO
LIGHT BLUE



H03
VERDE ACQUA
AQUA GREEN



062
VERDE CHIARO
LIGHT GREEN

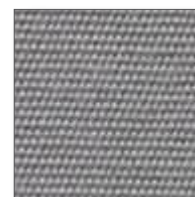

051
GRIGIO PERLA
PEARL GREY

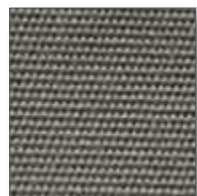

045
GRIGIO CHIARO
LIGHT GREY



050
GRIGIO SCURO
DARK GREY

I colori sono indicativi. Non è possibile garantire uniformità di tono nella tintura dei lotti di tessuto. Resta inteso che lievi differenze di colore verranno accettate al momento dell'ordine.

The colors are just indicative. Actually a steady tone of lots cannot be guaranteed. It remains understood that any slight colour difference will be accepted in case an order is placed.

CAT.B

381 ACRILICO OUTDOOR CIPRO/ACCIAIO VERNICIATO CATAFORESI-
ACRYLIC OUTDOOR CIPRO/PAINTED CATAPHORESIS STEEL

Sof Sof

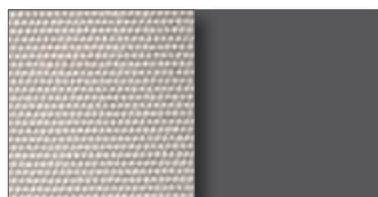

328
BIANCO/GRAFITE
WHITE/GRAPHITE

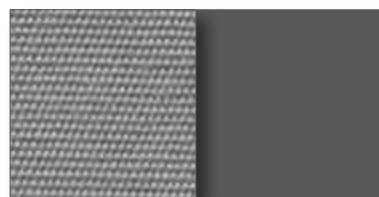

352
GRIGIO PERLA/GRAFITE
PEARL GREY/GRAPHITE

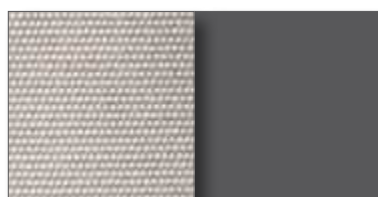

322
AVORIO/GRAFITE
IVORY/GRAPHITE

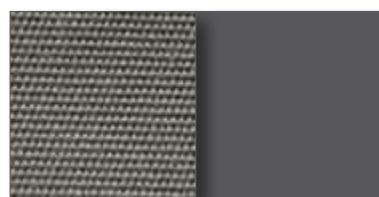

348
GRIGIO CHIARO/GRAFITE
LIGHT GREY/GRAPHITE

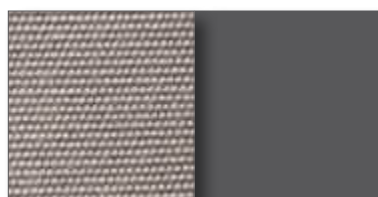

377
SABBIA/GRAFITE
SAND/GRAPHITE

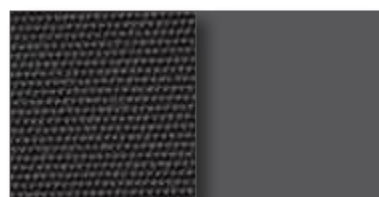

353
GRIGIO SCURO/GRAFITE
DARK GREY/GRAPHITE

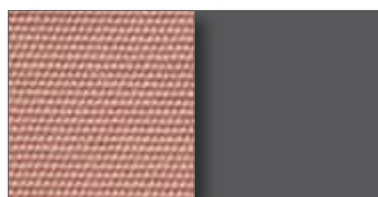

370
ROSA/GRAFITE
PINK/GRAPHITE

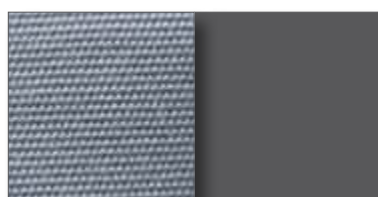

326
AZZURRO/GRAFITE
LIGHT BLUE/GRAPHITE



H07
VERDE ACQUA/GRAFITE
AQUA GREEN/GRAPHITE

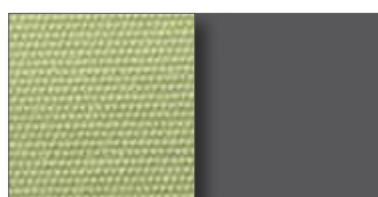

380
VERDE CHIARO/GRAFITE
LIGHT GREEN/GRAPHITE

CAT.B

381 ACRILICO OUTDOOR CIPRO/ACCIAIO VERNICIATO CATAFORESI-
ACRYLIC OUTDOOR CIPRO/PAINTED CATAPHORESIS STEEL

Elisa

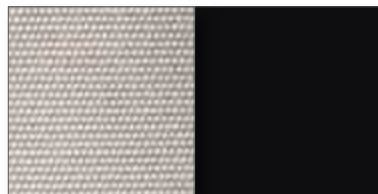

393
BIANCO/NERO MARRONE
WHITE/BLACK BROWN

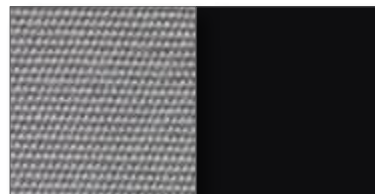

410
GRIGIO PERLA/NERO MARRONE
PEARL GREY/BLACK BROWN

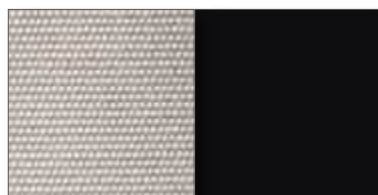

388
AVORIO/NERO MARRONE
IVORY/BLACK BROWN

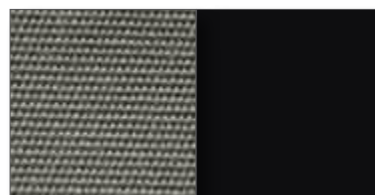

407
GRIGIO CHIARO/NERO MARRONE
LIGHT GREY/BLACK BROWN

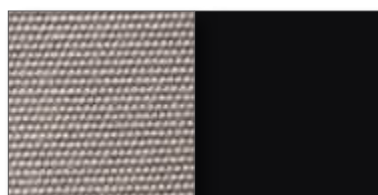

426
SABBIA/NERO MARRONE
SAND/BLACK BROWN

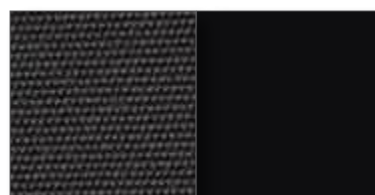

411
GRIGIO SCURO/NERO MARRONE
DARK GREY/BLACK BROWN

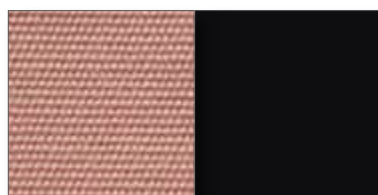

422
ROSA/NERO MARRONE
PINK/BLACK BROWN

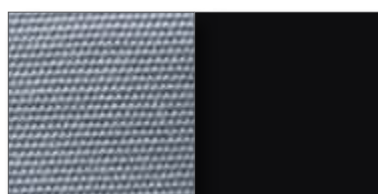

391
AZZURRO/NERO MARRONE
LIGHT BLUE/BLACK BROWN

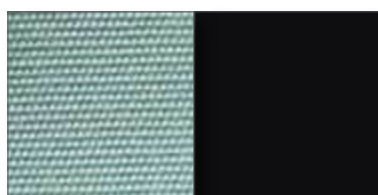

H08
VERDE ACQUA/NERO MARRONE
AQUA GREEN/BLACK BROWN

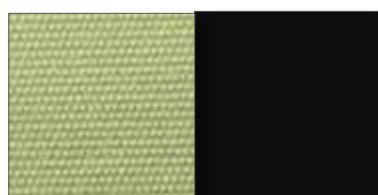

429
VERDE CHIARO/NERO MARRONE
LIGHT GREEN/BLACK BROWN

CAT.B

716 POLIPROPILENE PANTELLERIA - POLYPROPYLENE PANTELLERIA

Composizione/Composition: 100% RECPP. Altezza/Height: 138 cm. Peso/Weight: 460gr. Abrasione/Abrasion: 50.000 Martindale (uso pubblico, uso molto intensivo/public use, very intensive use). BS5852source 0,EN1021-1,CAL117/BS5852source 0,EN1021-1



002
BIANCO
WHITE



004
AVORIO
IVORY



011
SABBIA
SAND



024
ROSA
PINK



H03
VERDE ACQUA
AQUA GEEEN

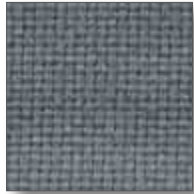

716
GRIGIO AZZURRO
GREY BLUE



072
BLU
BLU

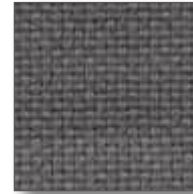

044
GRIGIO
GREY

I colori sono indicativi. Non è possibile garantire uniformità di tono nella tintura dei lotti di tessuto. Resta inteso che lievi differenze di colore verranno accettate al momento dell'ordine.

The colors are just indicative. Actually a steady tone of lots cannot be guaranteed. It remains understood that any slight colour difference will be accepted in case an order is placed.

CAT.B

837 POLIPROPILENE PANTELLERIA/ACCIAIO VERNICIATO CATAFORESI-
POLYPROPYLENE PANTELLERIA/PAINTED CATAPHORESIS STEEL

Sof Sof

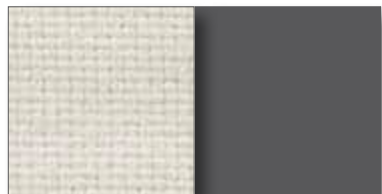

328
BIANCO/GRAFITE
WHITE/GRAPHITE

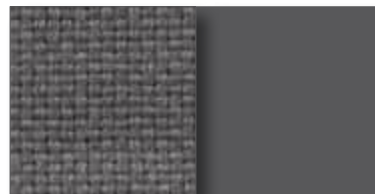

343
GRIGIO/GRAFITE
GREY/GRAPHITE



322
AVORIO/GRAFITE
IVORY/GRAPHITE

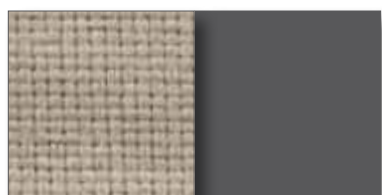

377
SABBIA/GRAFITE
SAND/GRAPHITE

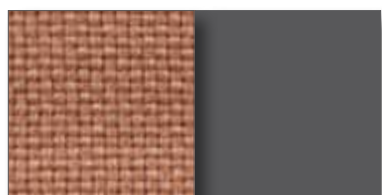

370
ROSA/GRAFITE
PINK/GRAPHITE

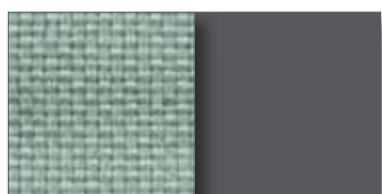

H07
VERDE ACQUA/GRAFITE
AQUA GREEN/GRAPHITE

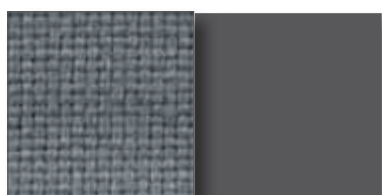

345
GRIGIO AZZURRO/GRAFITE
GREY BLUE/GRAPHITE

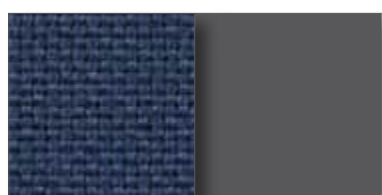

336
BLU/GRAFITE
BLUE/GRAPHITE

CAT.B

837 POLIPROPILENE PANTELLERIA/ACCIAIO VERNICIATO CATAFORESI-
POLYPROPYLENE PANTELLERIA/PAINTED CATAPHORESIS STEEL

Elisa

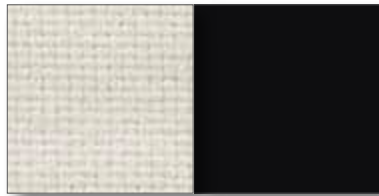

393
BIANCO/NERO MARRONE
WHITE/BLACK BROWN

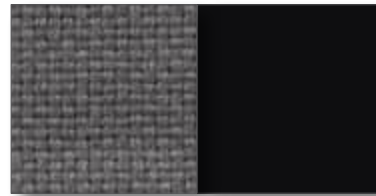

404
GRIGIO/NERO MARRONE
GREY/BLACK BROWN

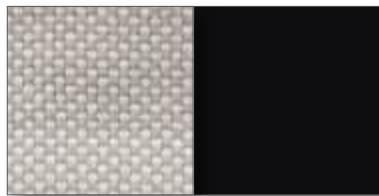

388
AVORIO/NERO MARRONE
IVORY/BLACK BROWN

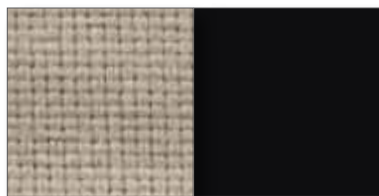

426
SABBIA/NERO MARRONE
SAND/BLACK BROWN

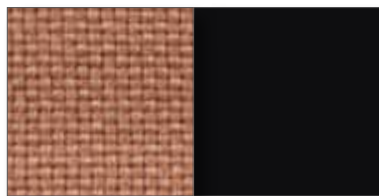

422
ROSA/NERO MARRONE
PINK/BLACK BROWN

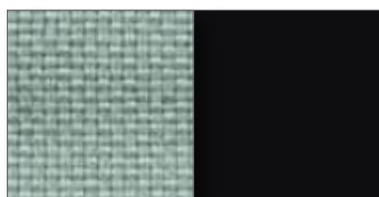

H08
VERDE ACQUA/NERO MARRONE
AQUA GREEN/BLACK BROWN

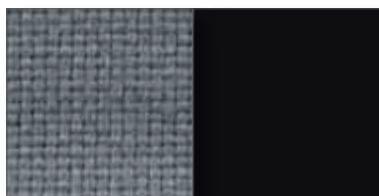

405
GRIGIO AZZURRO/NERO MARRONE
GREY BLUE/BLACK BROWN

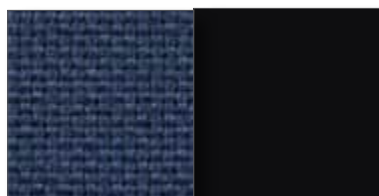





















400
BLU/NERO MARRONE
BLUE/BLACK BROWN

CAT.C

032 VELLUTO LOIRA - VELVET LOIRA

Composizione/Composition: 100% Velluto di cotone/Cotton velvet. Altezza/Height: 140 cm. Peso/Weight: 630gr. Abrasione/Abrasion: 100.000 Martindale (uso pubblico, uso molto intensivo/public use, very intensive use). CALTB117, BS5852 part 1 schedule 4 source 0



	004 AVORIO IVORY		011 SABBIA SAND		016 TORTORA TAUPE		024 ROSA PINK
	039 ROSSO RED		038 ROSSO SCURO DARK RED		040 BORDEAUX BURGUNDY		031 VIOLA SCURO DARK VIOLET
	063 VERDE GREEN		066 VERDE SCURO DARK GREEN		069 PETROLIO PETROL GREEN		071 BLU MEDIO MEDIUM BLUE
	E20 BLU NOTTE NIGHTBLUE		072 BLU BLUE		073 BLU SCURO DARK BLUE		044 GRIGIO GREY
	083 MARRONE SCURO DARK BROWN		041 GRIGIO GHIACCIO ICE GREY		050 GRIGIO SCURO DARK GREY		091 NERO BLACK

I colori sono indicativi. Non è possibile garantire uniformità di tono nella tintura dei lotti di tessuto. Resta inteso che lievi differenze di colore verranno accettate al momento dell'ordine.

The colors are just indicative. Actually a steady tone of lots cannot be guaranteed. It remains understood that any slight colour difference will be accepted in case an order is placed.

CAT.C

065 VELLUTO LOIRA/FRASSINO - LOIRA VELVET/ASH

La Francesea



172
AVORIO/NATURALE
IVORY/NATURAL



229
VIOLA SCURO/NATURALE
DARK VIOLET/NATURAL



221
SABBIA/NATURALE
SAND/NATURAL



225
VERDE/NATURALE
GREEN/NATURAL



224
TORTORA/NATURALE
TAUPE/NATURAL



227
VERDE SCURO/NATURALE
DARK GREEN/NATURAL



216
ROSA/NATURALE
PINK/NATURAL



212
PETROLIO/NATURALE
PETROL GREEN/NATURAL



219
ROSSO/NATURALE
RED/NATURAL



179
BLU MEDIO/NATURALE
MEDIUM BLUE/NATURAL

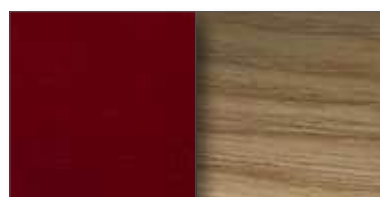

218
ROSSO SCURO/NATURALE
DARK RED/NATURAL



182
BLU NOTTE/NATURALE
NIGHT BLUE/NATURAL



183
BORDEAUX/NATURALE
BURGUNDY/NATURAL



182
BLU/NATURALE
BLUE/NATURAL

CAT.C

065 VELLUTO LOIRA/FRASSINO - LOIRA VELVET/ASH

La Francesa

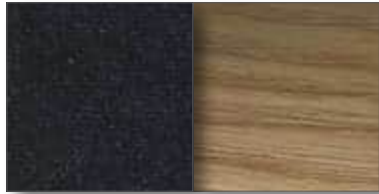

180
BLU SCURO/NATURALE
DARK BLUE/NATURAL



192
GRIGIO/NATURALE
GREY/NATURAL



203
MARRONE SCURO/NATURALE
DARK BROWN/NATURAL



198
GRIGIO GHIACCIO/NATURALE
ICE GREY/NATURAL

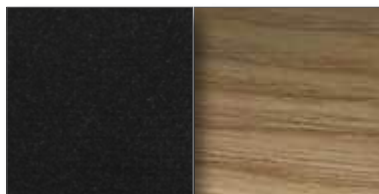

192
GRIGIO SCURO/NATURALE
DARK GREY/NATURAL

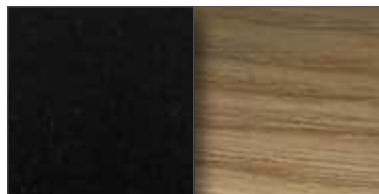

207
NERO/NATURALE
BLACK/NATURAL

CAT.C

065 VELLUTO LOIRA/FRASSINO - LOIRA VELVET/ASH

La Francese

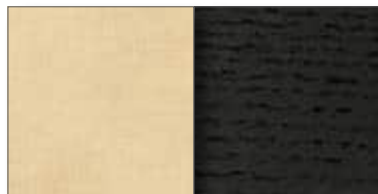

233
AVORIO/EBANIZZATO
IVORY/EBONIZED

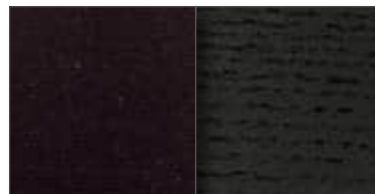

290
VIOLA SCURO/EBANIZZATO
DARK VIOLET/EBONIZED



282
SABBIA/EBANIZZATO
SAND/EBONIZED

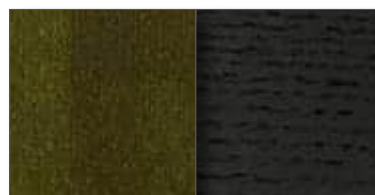

287
VERDE/EBANIZZATO
GREEN/EBONIZED



286
TORTORA/EBANIZZATO
TAUPE/EBONIZED



289
VERDE SCURO/EBANIZZATO
DARK GREEN/EBONIZED

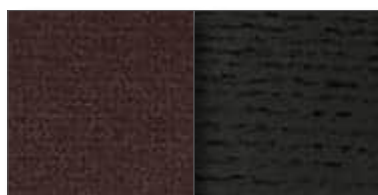

277
ROSA/EBANIZZATO
PINK/EBONIZED



273
PETROLIO/EBANIZZATO
PETROL GREEN/EBONIZED

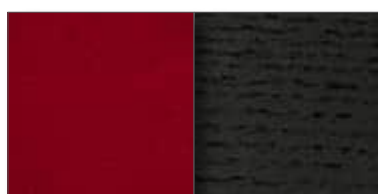

280
ROSSO/EBANIZZATO
RED/EBONIZED



239
BLU MEDIO/EBANIZZATO
MEDIUM BLUE/EBONIZED



279
ROSSO SCURO/EBANIZZATO
DARK RED/EBONIZED



E64
BLU NOTTE/EBANIZZATO
NIGHT BLUE/EBONIZED

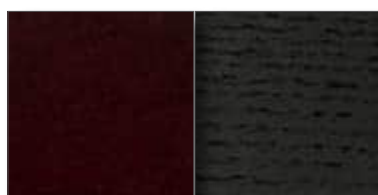

243
BORDEAUX/EBANIZZATO
BURGUNDY/EBONIZED

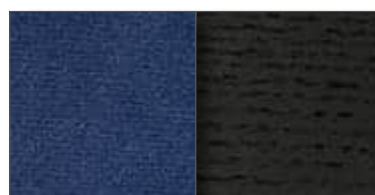

242
BLU/EBANIZZATO
BLUE/EBONIZED

CAT.C

065 VELLUTO LOIRA/FRASSINO - LOIRA VELVET/ASH

La Francesea



240
BLU SCURO/EBANIZZATO
DARK BLUE/EBONIZED

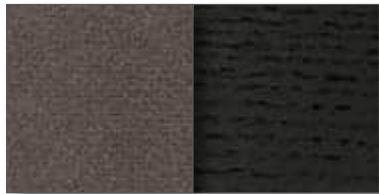

251
GRIGIO/EBANIZZATO
GREY/EBONIZED

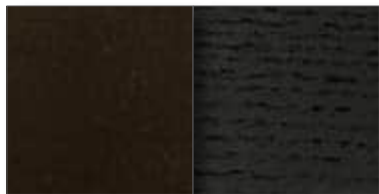

266
MARRONE/EBANIZZATO
BROWN/EBONIZED

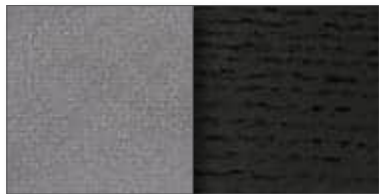

257
GRIGIO GHIACCIO/EBANIZZATO
ICE GREY/EBONIZED

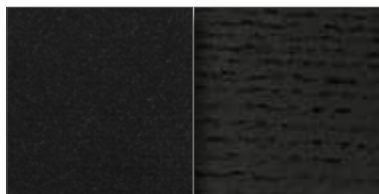

260
GRIGIO SCURO/EBANIZZATO
DARK GREY/EBONIZED



267
NERO/EBANIZZATO
BLACK/EBONIZED

CAT.C

134 VELLUTO LOIRA/ACCIAIO VERNICIATO - LOIRA VELVET/PAINTED STEEL

Sof Sof, 33 Cuscini

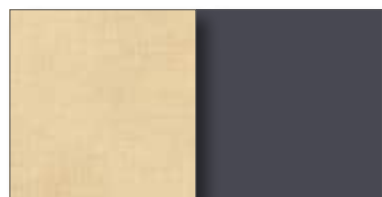

322
AVORIO/GRAFITE
IVORY/GRAPHITE

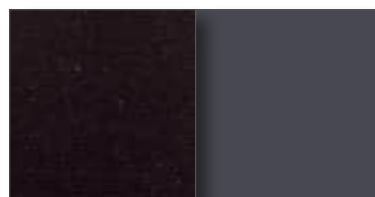

385
VIOLA SCURO/GRAFITE
DARK VIOLET/GRAPHITE

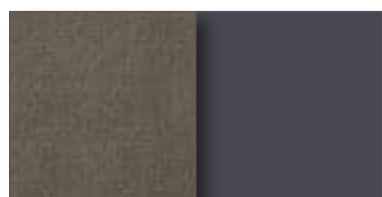

377
SABBIA/GRAFITE
SAND/GRAPHITE

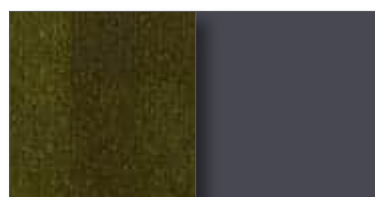

379
VERDE/GRAFITE
GREEN/GRAPHITE

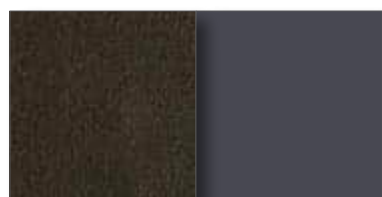

378
TORTORA/GRAFITE
TAUPE/GRAPHITE

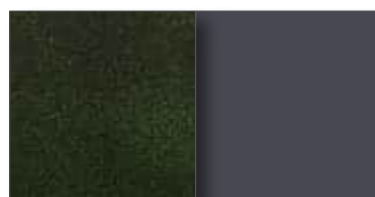

384
VERDE SCURO/GRAFITE
DARK GREEN/GRAPHITE

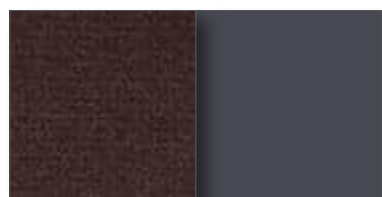

370
ROSA/GRAFITE
PINK/GRAPHITE

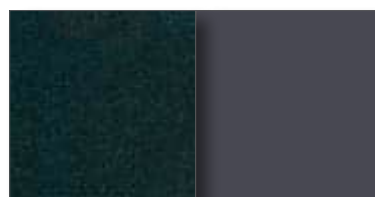

367
PETROLIO/GRAFITE
PETROL GREEN/GRAPHITE



374
ROSSO/GRAFITE
RED/GRAPHITE

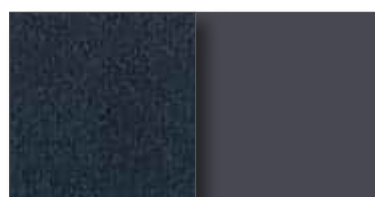

333
BLU MEDIO/GRAFITE
IVORY/GRAPHITE



373
ROSSO SCURO/GRAFITE
DARK RED/GRAPHITE

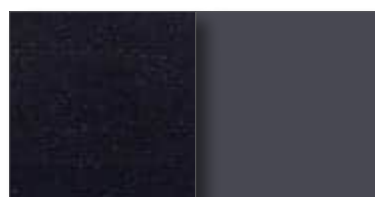

E65
BLU NOTTE/GRAFITE
NIGHT BLUE/GRAPHITE

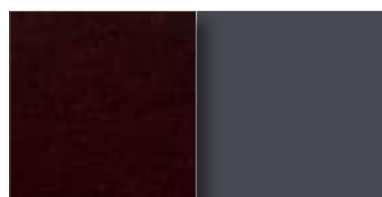

337
BORDEAUX/GRAFITE
BURGUNDY/GRAPHITE



336
BLU/GRAFITE
BLUE/GRAPHITE

CAT.C

134 VELLUTO LOIRA/ACCIAIO VERNICIATO - LOIRA VELVET/PAINTED STEEL

Sof Sof, 33 Cuscini

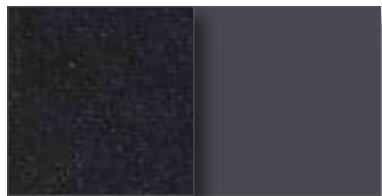

334
BLU SCURO/GRAFITE
DARK BLUE/GRAPHITE

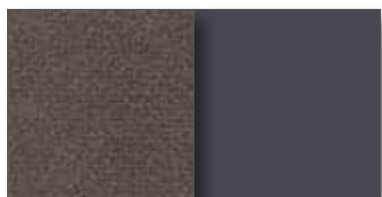

343
GRIGIO/GRAFITE
GREY/GRAPHITE

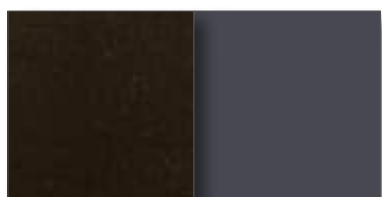

359
MARRONE SCURO/GRAFITE
DARK BROWN/GRAPHITE

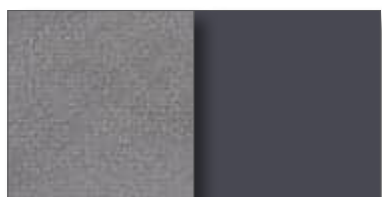

349
GRIGIO GHIACCIO/GRAFITE
ICE GREY/GRAPHITE

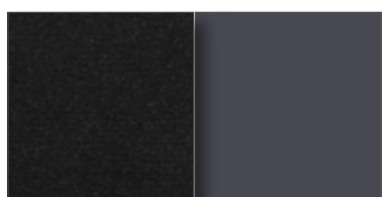

353
GRIGIO SCURO/GRAFITE
DARK GREY/GRAPHITE

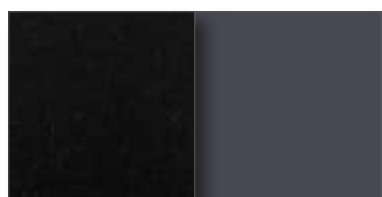

361
NERO/GRAFITE
BLACK/GRAPHITE

CAT.C

134 VELLUTO LOIRA/ACCIAIO VERNICIATO - LOIRA VELVET/PAINTED STEEL

Elisa

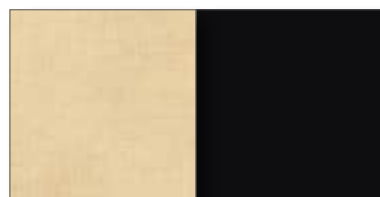

388
AVORIO/NERO MARRONE
IVORY/BLACK BROWN

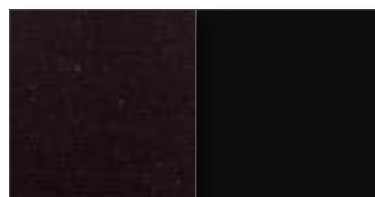

433
VIOLA SCURO/NERO MARRONE
DARK VIOLET/BLACK BROWN

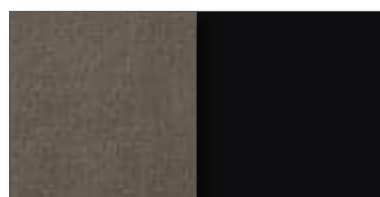

426
SABBIA/NERO MARRONE
SAND/BLACK BROWN



428
VERDE/NERO MARRONE
GREEN/BLACK BROWN

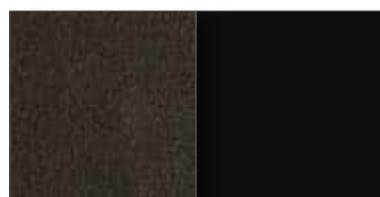

427
TORTORA/NERO MARRONE
TAUPE/BLACK BROWN

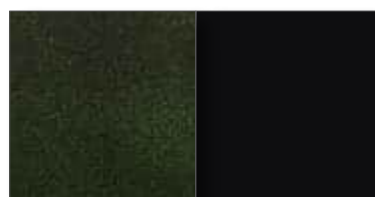

432
VERDE SCURO/NERO MARRONE
DARK GREEN/BLACK BROWN

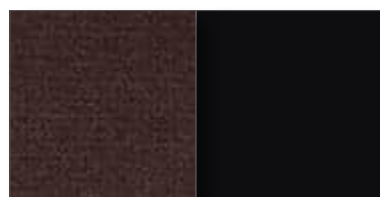

422
ROSA/NERO MARRONE
PINK/BLACK BROWN



419
PETROLIO/NERO MARRONE
PETROL GREEN/BLACK BROWN



424
ROSSO/NERO MARRONE
RED/BLACK BROWN

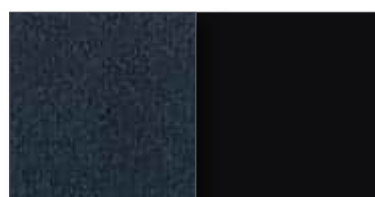

397
BLU MEDIO/NERO MARRONE
MEDIUM BLUE/BLACK BROWN



423
ROSSO SCURO/NERO MARRONE
DARK RED/BLACK BROWN

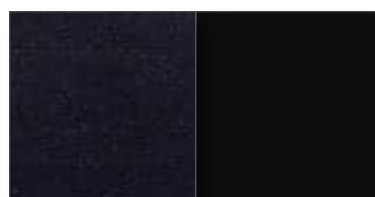

G56
BLU NOTTE/NERO MARRONE
NIGHT BLUE/BLACK BROWN

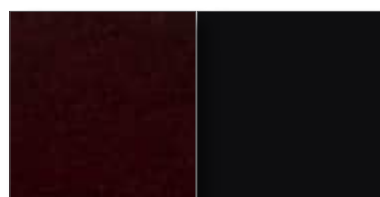

401
BORDEAUX/NERO MARRONE
BURGUNDY/BLACK BROWN

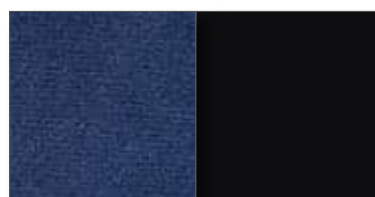

400
BLU/NERO MARRONE
BLUE/BLACK BROWN

CAT.C

134 VELLUTO LOIRA/ACCIAIO VERNICIATO - LOIRA VELVET/PAINTED STEEL

Elisa

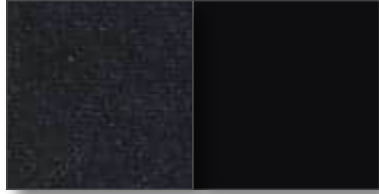

398

BLU SCURO/NERO MARRONE
DARK BLUE/BLACK BROWN

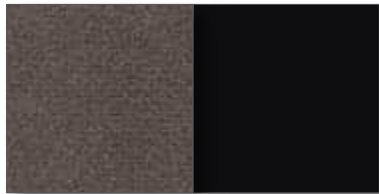

404

GRIGIO/NERO MARRONE
GREY/BLACK BROWN

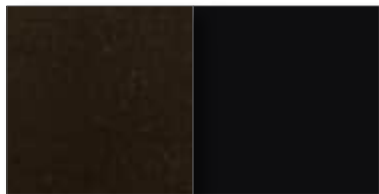

415

MARRONE SCURO/NERO MARRONE
DARK BROWN/BLACK BROWN

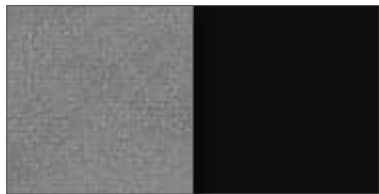

408

GRIGIO GHIACCIO/NERO MARRONE
ICE GREY/BLACK BROWN

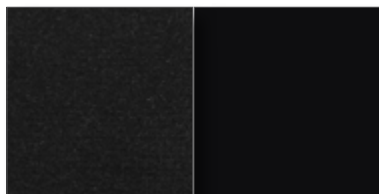

411

GRIGIO SCURO/NERO MARRONE
DARK GREY/BLACK BROWN

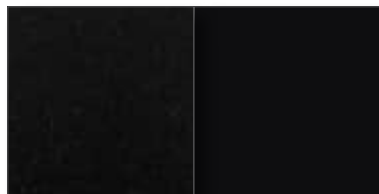

417

NERO/NERO MARRONE
BLACK/BLACK BROWN

CAT.C

134 VELLUTO LOIRA/ACCIAIO VERNICIATO - LOIRA VELVET/PAINTED STEEL

Fenix



436
AVORIO/PELTRO BRONZATO
IVORY/BRONZE PEWTER

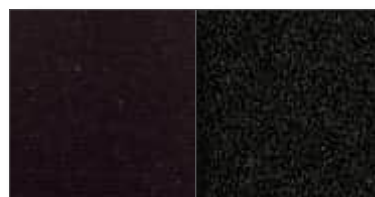

508
VIOLA SCURO/PELTRO BRONZATO
DARK VIOLET/BRONZE PEWTER



498
SABBIA/PELTRO BRONZATO
SAND/BRONZE PEWTER



502
VERDE/PELTRO BRONZATO
GREEN/BRONZE PEWTER

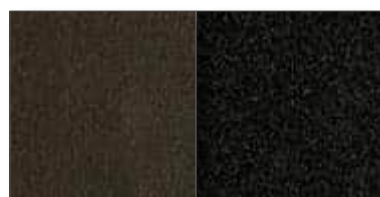

501
TORTORA/PELTRO BRONZATO
TAUPE/BRONZE PEWTER



507
VERDE SCURO/PELTRO BRONZATO
DARK GREEN/BRONZE PEWTER

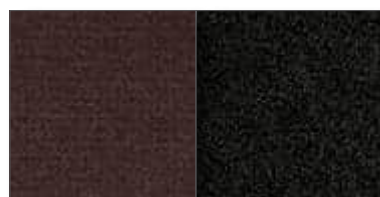

490
ROSA/PELTRO BRONZATO
PINK/BRONZE PEWTER



486
PETROLIO/PELTRO BRONZATO
PETROL GREEN/BRONZE PEWTER



494
ROSSO/PELTRO BRONZATO
RED/BRONZE PEWTER



447
BLU MEDIO/PELTRO BRONZATO
MEDIUM BLUE/BRONZE PEWTER



493
ROSSO SCURO/PELTRO BRONZATO
DARK RED/BRONZE PEWTER



450
BLU NOTTE/PELTRO BRONZATO
NIGHT BLUE/BRONZE PEWTER



451
BORDEAUX/PELTRO BRONZATO
BURGUNDY/BRONZE PEWTER



450
BLU/PELTRO BRONZATO
BLUE/BRONZE PEWTER

CAT.C

134 VELLUTO LOIRA/ACCIAIO VERNICIATO - LOIRA VELVET/PAINTED STEEL

Fenix



448

BLU SCURO/PELTRO BRONZATO
DARK BLUE/BRONZE PEWTER



461

GRIGIO/PELTRO BRONZATO
GREY/BRONZE PEWTER



477

MARRONE SCURO/PELTRO BRONZATO
DARK BROWN/BRONZE PEWTER



467

GRIGIO GHIACCIO/PELTRO BRONZATO
ICE GREY/BRONZE PEWTER

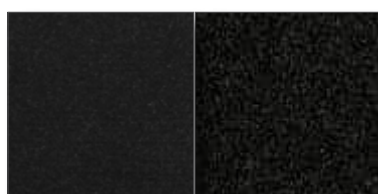

471

GRIGIO SCURO/PELTRO BRONZATO
DARK GREY/BRONZE PEWTER

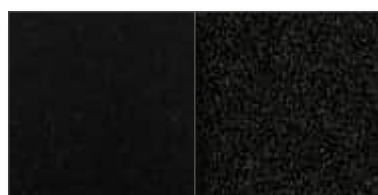

479

NERO/PELTRO BRONZATO
BLACK/BRONZE PEWTER

CAT.C

134 VELLUTO LOIRA/ACCIAIO VERNICIATO - LOIRA VELVET/PAINTED STEEL

Cocky



590
AVORIO/NERO
IVORY/BLACK

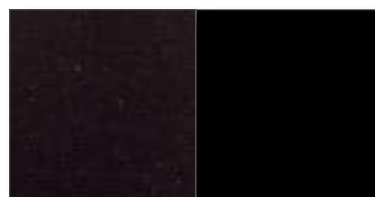

662
VIOLA SCURO/NERO
DARK VIOLET/BLACK



426
SABBIA/NERO
SAND/BLACK



656
VERDE/NERO
GREEN/BLACK

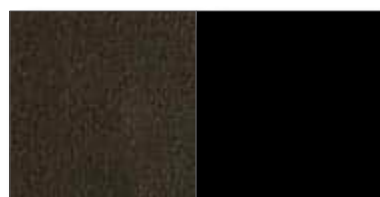

655
TORTORA/NERO
TAUPE/BLACK

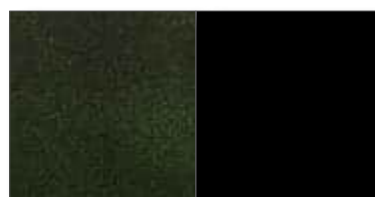

661
VERDE SCURO/NERO
DARK GREEN/BLACK

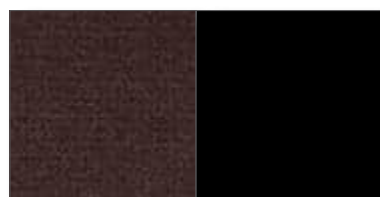

643
ROSA/NERO
PINK/BLACK

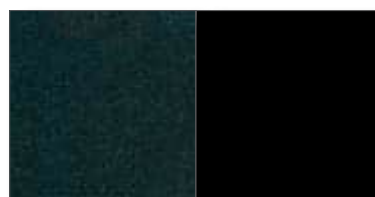

639
PETROLIO/NERO
PETROL GREEN/BLACK



647
ROSSO/NERO
RED/BLACK



601
BLU MEDIO/NERO
MEDIUM BLUE/BLACK



646
ROSSO SCURO/NERO
DARK RED/BLACK



E69
BLU NOTTE/NERO
NIGHT BLU/BLACK

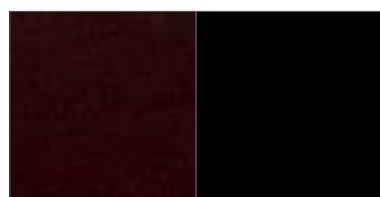

605
BORDEAUX/NERO
BURGUNDY/BLACK



604
BLU/NERO
BLU/BLACK

CAT.C

134 VELLUTO LOIRA/ACCIAIO VERNICIATO - LOIRA VELVET/PAINTED STEEL

Cocky

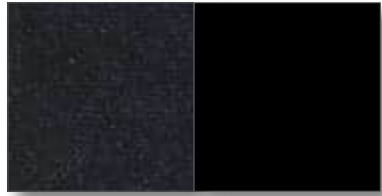

602
BLU SCURO/NERO
DARK BLUE/BLACK



615
GRIGIO/NERO
GREY/BLACK

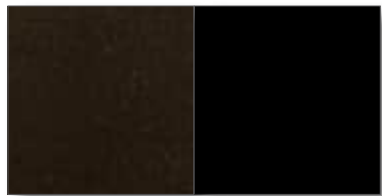

630
MARRONE SCURO/NERO
DARK BROWN/BLACK



621
GRIGIO GHIACCIO/NERO
ICE GREY/BLACK

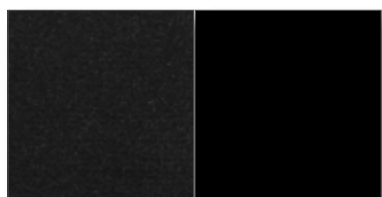

625
GRIGIO SCURONERO
DARK GREY/BLACK



632
NERONERO
BLACK/BLACK

CAT.C

199 VELLUTO LOIRA/ALLUMINIO LUCIDATO - LOIRA VELVET/POLISHED ALUMINUM

Lou Speak, Cocky

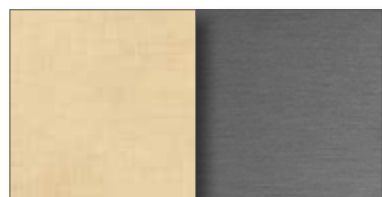

526
AVORIO/ALLUMINIO
IVORY/ALUMINUM



586
VIOLA SCURO/ALLUMINIO
DARK VIOLET/ALUMINUM

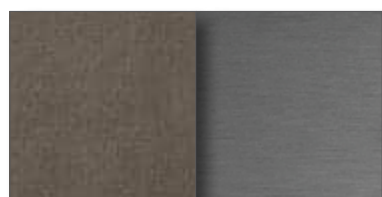

578
SABBIA/ALLUMINIO
SAND/ALUMINUM



544
VERDE/ALLUMINIO
GREEN/ALUMINUM

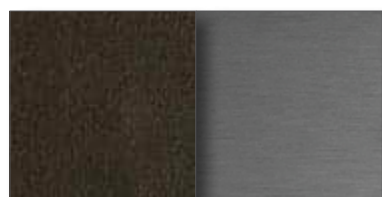

582
TORTORA/ALLUMINIO
TAUPE/ALUMINUM

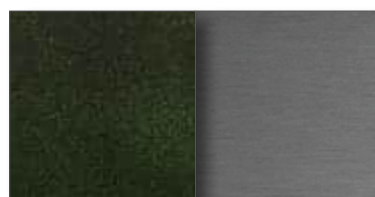

585
VERDE SCURO/ALLUMINIO
DARK GREEN/ALUMINUM

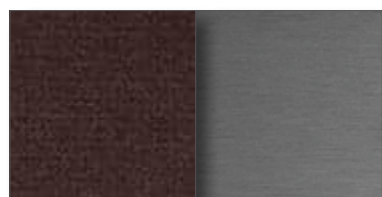

572
ROSA/ALLUMINIO
PINK/ALUMINUM

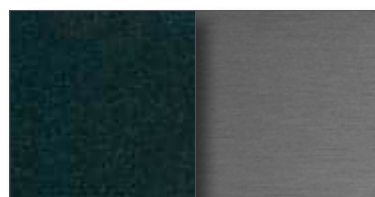

568
PETROLIO/ALLUMINIO
PETROL GREEN/ALUMINUM

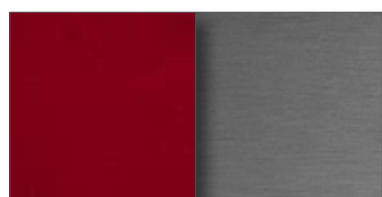

575
ROSSO/ALLUMINIO
RED/ALUMINUM

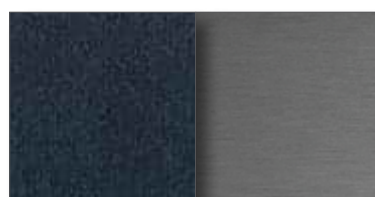

533
BLU MEDIO/ALLUMINIO
MEDIUM BLUE/ALUMINUM

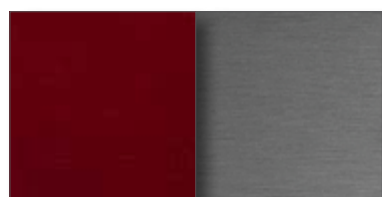

574
ROSSO SCURO/ALLUMINIO
DARK RED/ALUMINUM



E68
BLU NOTTE/ALLUMINIO
NIGHT BLUE/ALUMINUM

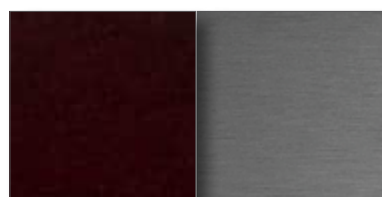

537
BORDEAUX/ALLUMINIO
BURGUNDY/ALUMINUM

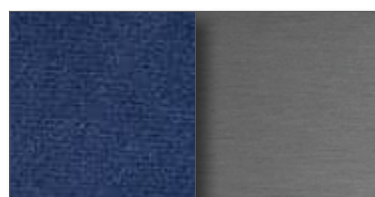

536
BLU/ALLUMINIO
BLUE/ALUMINUM

CAT.C

199 VELLUTO LOIRA/ALLUMINIO LUCIDATO - LOIRA VELVET/POLISHED ALUMINUM

Lou Speak, Cocky

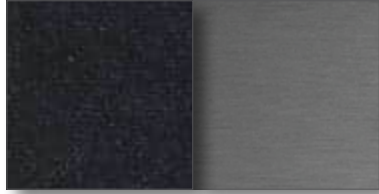

534
BLU SCURO/ALLUMINIO
DARK BLUE/ALUMINUM

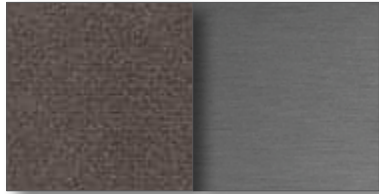

545
GRIGIO/ALLUMINIO
GREY/ALUMINUM

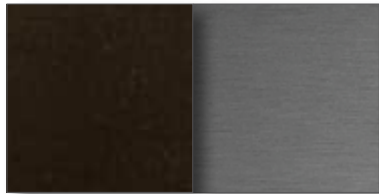

559
MARRONE SCURO/ALLUMINIO
DARK BROWN/ALUMINUM

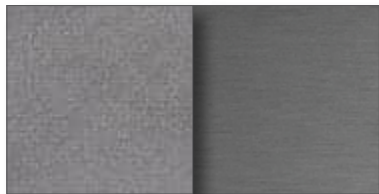

551
GRIGIO GHIACCIO/ALLUMINIO
ICE GREY/ALUMINUM

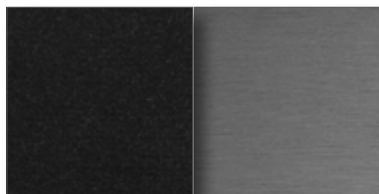

554
GRIGIO SCURO/ALLUMINIO
DARK GREY/ALUMINUM

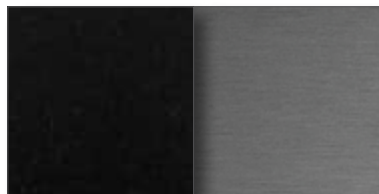

561
NERO/ALLUMINIO
BLACK/ALUMINUM

CAT.C

228 VELLUTO LOIRA/ALLUMINIO VERNICIATO - LOIRA VELVET/PAINTED ALUMINUM

Lirica, Lirico

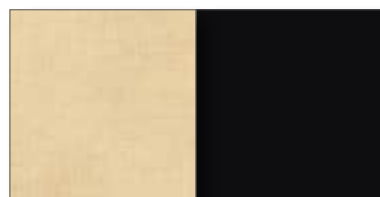

590
AVORIO/NERO
IVORY/BLACK

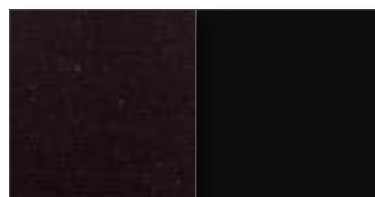

662
VIOLA SCURO/NERO
DARK VIOLET/BLACK

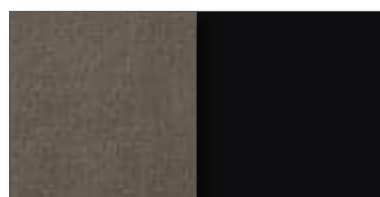

651
SABBIA/NERO
SAND/BLACK



656
VERDE/NERO
GREEN/BLACK

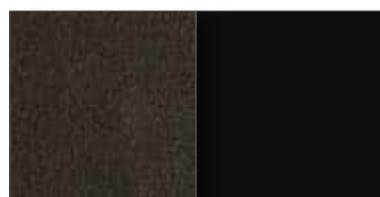

655
TORTORA/NERO
TAUPE/BLACK

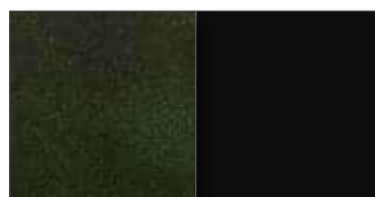

661
VERDE SCURO/NERO
DARK GREEN/BLACK

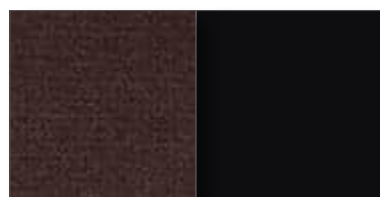

643
ROSA/NERO
PINK/BLACK



639
PETROLIO/NERO
PETROL GREEN/BLACK



647
ROSSO/NERO
RED/BLACK

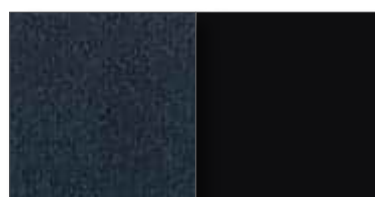

601
BLU MEDIO/NERO
MEDIUM BLUE/BLACK



646
ROSSO SCURO/NERO
DARK RED/BLACK

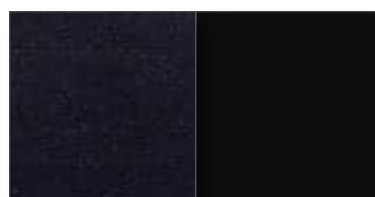

E69
BLU NOTTE/NERO
NIGHT BLUE/BLACK

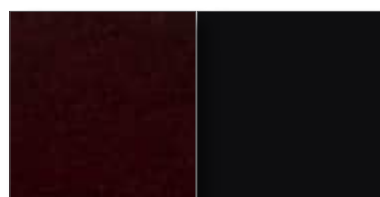

605
BORDEAUX/NERO
BURGUNDY/BLACK

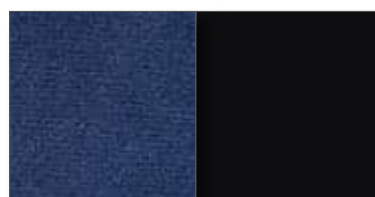

604
BLU/NERO
BLUE/BLACK

CAT.C

228 VELLUTO LOIRA/ALLUMINIO VERNICIATO - LOIRA VELVET/PAINTED ALUMINUM

Lirica, Lirico

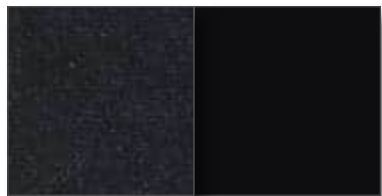

602
BLU SCURO/NERO
DARK BLUE/BLACK

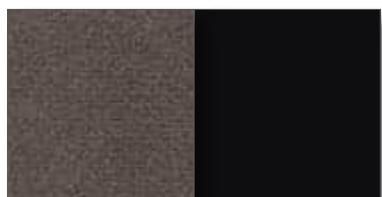

615
GRIGIO/NERO
GREY/BLACK

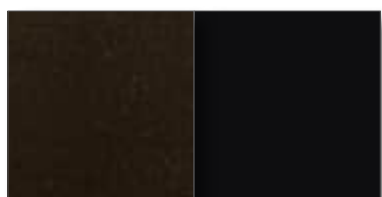

630
MARRONE SCURO/NERO
DARK BROWN/BLACK

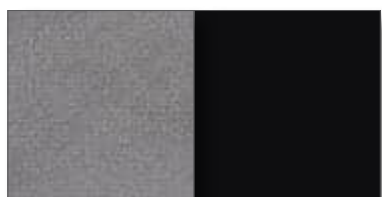

621
GRIGIO GHIACCIO/NERO
ICE GREY/BLACK

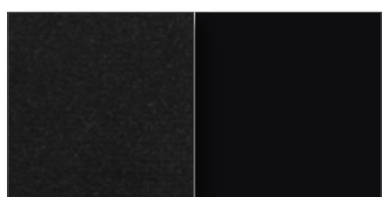

625
GRIGIO SCURO/NERO
DARK GREY/BLACK

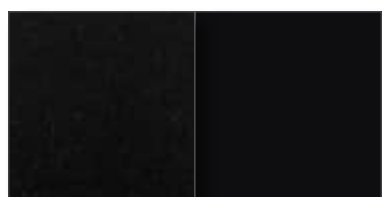

632
NERO/NERO
BLACK/BLACK

CAT.C

228 VELLUTO LOIRA/ALLUMINIO VERNICIATO - LOIRA VELVET/PAINTED ALUMINUM

Lirica, Lirico



716
AVORIO/ARGENTO
IVORY/SILVER



789
VIOLA SCURO/ARGENTO
DARK VIOLET/SILVER



778
SABBIA/ARGENTO
SAND/SILVER



783
VERDE/ARGENTO
GREEN/SILVER



782
TORTORA/ARGENTO
TAUPE/SILVER



788
VERDE SCURO/ARGENTO
DARK GREEN/SILVER



770
ROSA/ARGENTO
PINK/SILVER



766
PETROLIO/ARGENTO
PETROL GREEN/SILVER

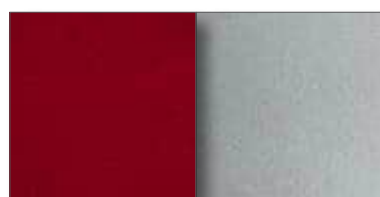

774
ROSSO/ARGENTO
RED/SILVER



727
BLU MEDIO/ARGENTO
MEDIUM BLUE/SILVER



773
ROSSO SCURO/ARGENTO
DARK RED/SILVER



E70
BLU NOTTE/ARGENTO
NIGHT BLUE/SILVER

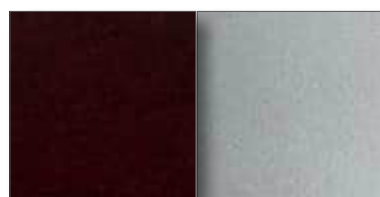

731
BORDEAUX/ARGENTO
BURGUNDY/SILVER



730
BLU/ARGENTO
BLUE/SILVER

CAT.C

228 VELLUTO LOIRA/ALLUMINIO VERNICIATO - LOIRA VELVET/PAINTED ALUMINUM

Lirica, Lirico



728
BLU SCURO/ARGENTO
DARK BLUE/SILVER



741
GRIGIO/ARGENTO
GREY/SILVER



757
MARRONE SCURO/ARGENTO
DARK BROWN/SILVER



746
GRIGIO GHIACCIO/ARGENTO
ICE GREY/SILVER



751
GRIGIO SCURO/ARGENTO
DARK GREY/SILVER



759
NERO/ARGENTO
BLACK/SILVER

CAT.C

321 VELLUTO LOIRA/FAGGIO LACCATO - LOIRA VELVET/LACQUERED BEECH

S.Marco, S.Marco Lounge

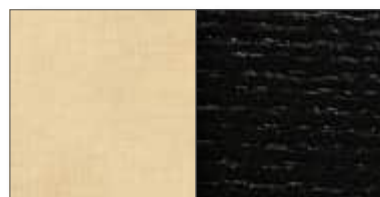

590
AVORIO/NERO
IVORY/BLACK



662
VIOLA SCURO/NERO
DARK VIOLET/BLACK



651
SABBIA/NERO
SAND/BLACK



656
VERDE/NERO
GREEN/BLACK



655
TORTORA/NERO
TAUPE/BLACK



661
VERDE SCURO/NERO
DARK GREEN/BLACK



643
ROSA/NERO
PINK/BLACK



639
PETROLIO/NERO
PETROL GREEN/BLACK



647
ROSSO/NERO
RED/BLACK



601
BLU MEDIO/NERO
MEDIUM BLUE/BLACK



646
ROSSO SCURO/NERO
DARK RED/BLACK



E69
BLU NOTTE/NERO
NIGHT BLUE/BLACK



605
BORDEAUX/NERO
BURGUNDY/BLACK



604
BLU/NERO
BLUE/BLACK

CAT.C

321 VELLUTO LOIRA/FAGGIO LACCATO - LOIRA VELVET/LACQUERED BEECH

S.Marco, S.Marco Lounge



602
BLU SCURO/NERO
DARK BLUE/BLACKL



615
GRIGIO/NERO
GREY/BLACK

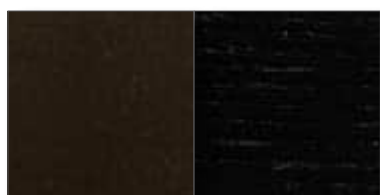

630
MARRONE SCURO/NERO
DARK BROWN/BLACK



621
GRIGIO GHIACCIO/NERO
ICE GREY/BLACK

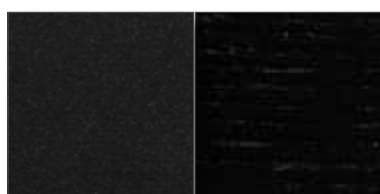

625
GRIGIO SCURO/NERO
DARK GREY/BLACK

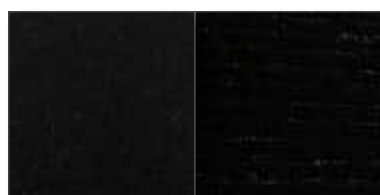

632
NERO/NERO
BLACK/BLACK

CAT.C

403 PU RIGIDO VERNICIATO/VELLUTO LOIRA/ACCIAIO CROMATO
STIFF PAINTED PU/LOIRA VELVET/CHROMED STEEL

Moon



859
MATTONE/AVORIO/CROMO
RED BRICK/IVORY/CHROME

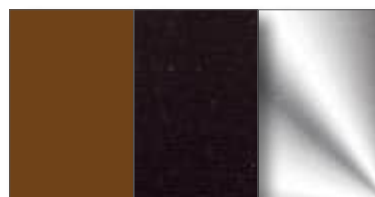

927
MATTONE/VIOLA SCURO/CROMO
RED BRICK/DARK VIOLET/CHROME

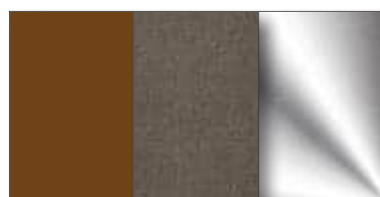

917
MATTONE/SABBIA/CROMO
RED BRICK/SAND/CHROME

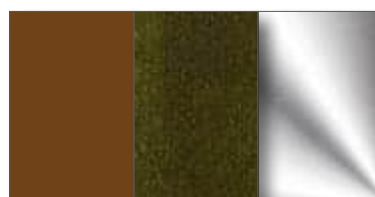

921
MATTONE/VERDE/CROMO
RED BRICK/GREEN/CHROME

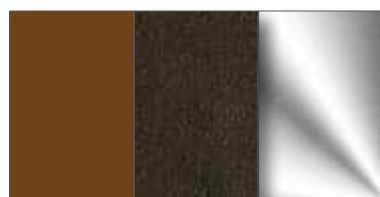

920
MATTONE/TORTORA/CROMO
RED BRICK/TAUPE/CHROME

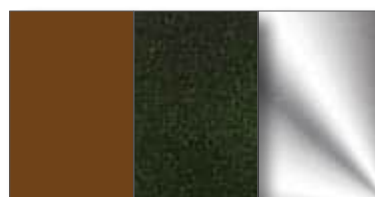

926
MATTONE/VERDE SCURO/CROMO
RED BRICK/DARK GREEN/CHROME

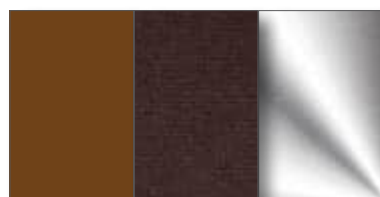

909
MATTONE/ROSA/CROMO
RED BRICK/PINK/CHROME



905
MATTONE/PETROLIO/CROMO
RED BRICK/PETROL GREEN/CHROME

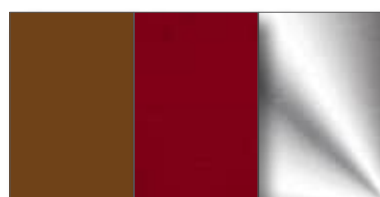

913
MATTONE/ROSSO/CROMO
RED BRICK/RED/CHROME



868
MATTONE/BLU MEDIO/CROMO
RED BRICK/MEDIUM BLUE/CHROME

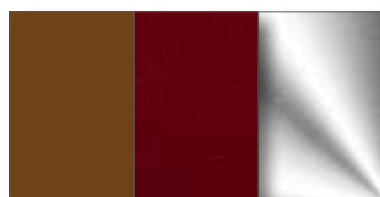

912
MATTONE/ROSSO SCURO/CROMO
RED BRICK/DARK RED/CHROME

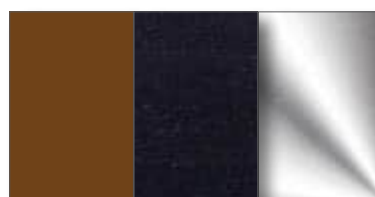

871
MATTONE/BLU NOTTE/CROMO
RED BRICK/NIGHT BLUE/CHROME

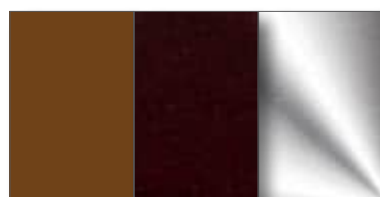

872
MATTONE/BORDEAUX/CROMO
RED BRICK/BURGUNDY/CHROME



871
MATTONE/BLU/CROMO
RED BRICK/BLU/CHROME

CAT.C

403 PU RIGIDO VERNICIATO/VELLUTO LOIRA/ACCIAIO CROMATO
 STIFF PAINTED PU/LOIRA VELVET/CHROMED STEEL

Moon

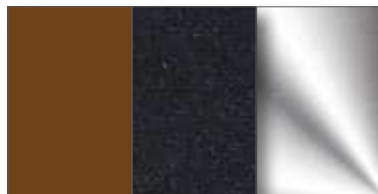

869
 MATTONE/BLU SCURO/CROMO
RED BRICK/DARK BLUE/CHROME

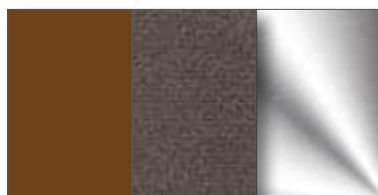

881
 MATTONE/GRIGIO/CROMO
RED BRICK/GREY/CHROME



897
 MATTONE/MARRONE SCURO/CROMO
RED BRICK/DARK GREY/CHROME

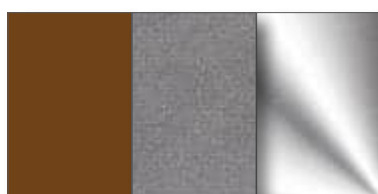

887
 MATTONE/GRIGIO GHIACCIO/CROMO
RED BRICK/ICE GREY/CHROME

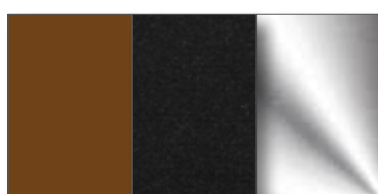

891
 MATTONE/GRIGIO SCURO/CROMO
RED BRICK/DARK GREY/CHROME



899
 MATTONE/NERO/CROMO
RED BRICK/BLACK/CHROME

CAT.C

403 PU RIGIDO VERNICIATO/VELLUTO LOIRA/ACCIAIO CROMATO
STIFF PAINTED PU/LOIRA VELVET/CHROMED STEEL

Moon



931
ECRU/AVORIO/CROMO
ECRU/IVORY/CHROME

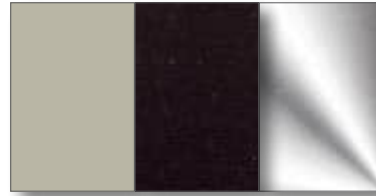

999
ECRU/VIOLA SCURO/CROMO
ECRU/DARK VIOLET/CHROME

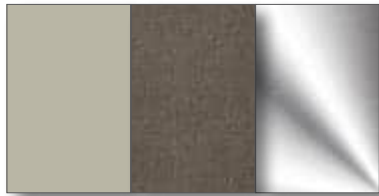

989
ECRU/SABBIA/CROMO
ECRU/SAND/CHROME



993
ECRU/VERDE/CROMO
ECRU/GREEN/CHROME



992
ECRU/TORTORA/CROMO
ECRU/TAUPE/CHROME



998
ECRU/VERDE SCURO/CROMO
ECRU/DARK GREEN/CHROME

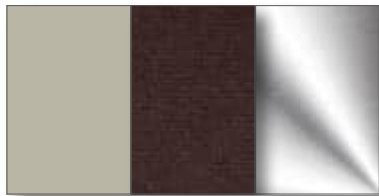

981
ECRU/ROSA/CROMO
ECRU/PINK/CHROME

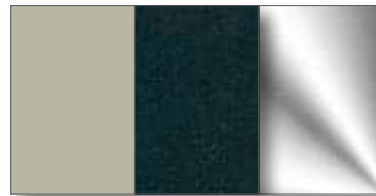

977
ECRU/PETROLIO/CROMO
ECRU/PETROL GREEN/CHROME

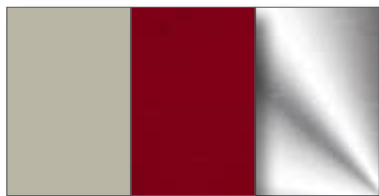

985
ECRU/ROSSO/CROMO
ECRU/RED/CHROME

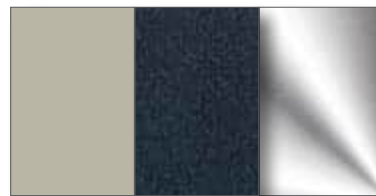

940
ECRU/BLU MEDIO/CROMO
ECRU/MEDIUM BLUE/CHROME

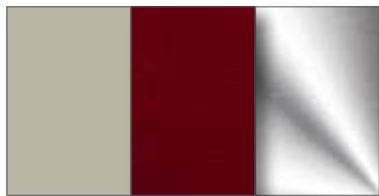

984
ECRU/ROSSO SCURO/CROMO
ECRU/DARK RED/CHROME

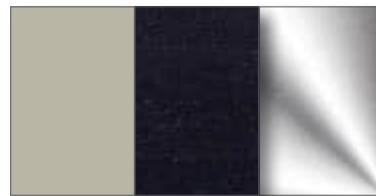

943
ECRU/BLU NOTTE/CROMO
ECRU/NIGHT BLUE/CHROME

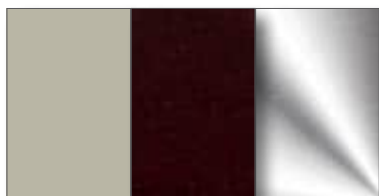

944
ECRU/BORDEAUX/CROMO
ECRU/BURGUNDY/CHROME

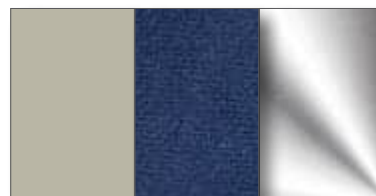

943
ECRU/BLU/CROMO
ECRU/BLUE/CHROME

CAT.C

403 PU RIGIDO VERNICIATO/VELLUTO LOIRA/ACCIAIO CROMATO
 STIFF PAINTED PU/LOIRA VELVET/CHROMED STEEL

Moon

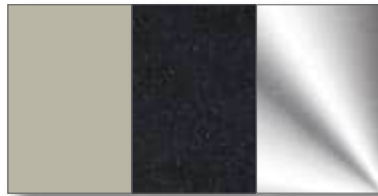

941
 ECRU/BLU SCURO/CROMO
 ECRU/DARK BLUE/CHROME

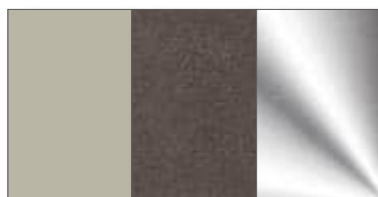

953
 ECRU/GRIGIO/CROMO
 ECRU/GREY/CHROME

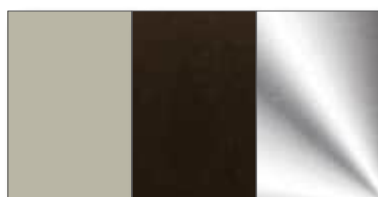

969
 ECRU/MARRONE SCURO/CROMO
 ECRU/DARK BROWN/CHROME



959
 ECRU/GRIGIO GHIACCIO/CROMO
 ECRU/ICE GREY/CHROME

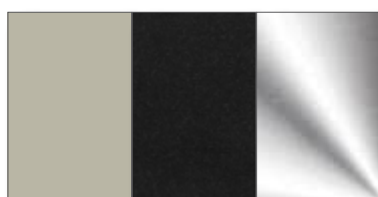

963
 ECRU/GRIGIO SCURO/CROMO
 ECRU/DARK GREY/CHROME

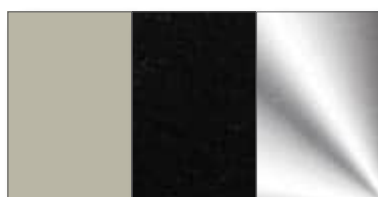

971
 ECRU/NERO/CROMO
 ECRU/BLACK/CHROME

CAT.C

403 PU RIGIDO VERNICIATO/VELLUTO LOIRA/ACCIAIO CROMATO
STIFF PAINTED PU/LOIRA VELVET/CHROMED STEEL

Moon

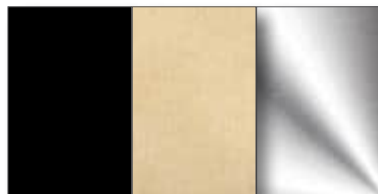

A03
NERO/AVORIO/CROMO
BLACK/IVORY/CHROME

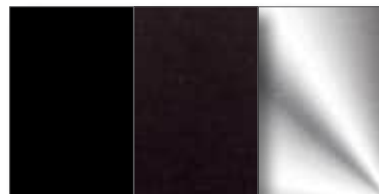

A71
NERO/VIOLA SCURO/CROMO
BLACK/DARK VIOLET/CHROME

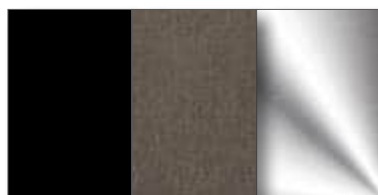

A61
NERO/SABBIA/CROMO
BLACK/SAND/CHROME

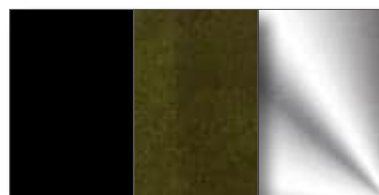

A65
NERO/VERDE/CROMO
BLACK/GREEN/CHROME

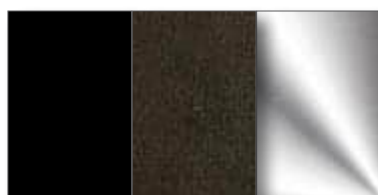

A64
NERO/TORTORA/CROMO
BLACK/TAUPE/CHROME

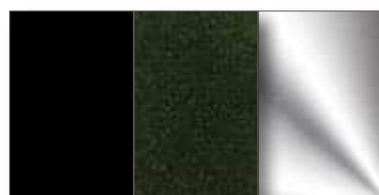

A70
NERO/VERDE SCURO/CROMO
BLACK/DARK GREEN/CHROME

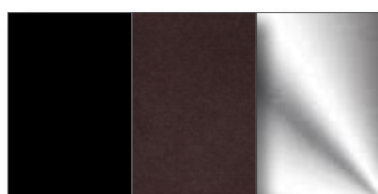

A53
NERO/ROSA/CROMO
BLACK/PINK/CHROME

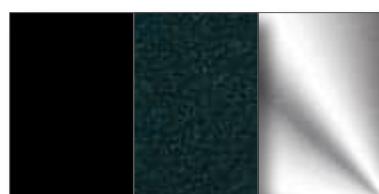

A49
NERO/PETROLIO/CROMO
BLACK/PETROL GREEN/CHROME



A57
NERO/ROSSO/CROMO
BLACK/RED/CHROME

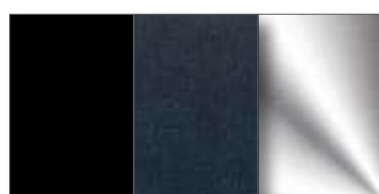

A12
NERO/BLU MEDIO/CROMO
BLACK/MEDIUM BLUE/CHROME



A56
NERO/ROSSO SCURO/CROMO
BLACK/DARK RED/CHROME

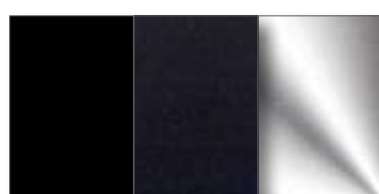

A15
NERO/BLU NOTTE/CROMO
BLACK/NIGHT BLUE/CHROME

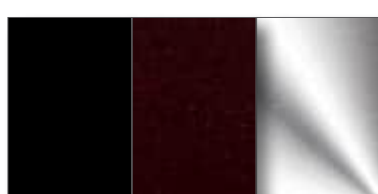

A16
NERO/BORDEAUX/CROMO
BLACK/BURGUNDY/CHROME

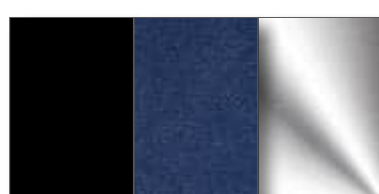

A15
NERO/BLU/CROMO
BLACK/BLUE/CHROME

CAT.C

403 PU RIGIDO VERNICIATO/VELLUTO LOIRA/ACCIAIO CROMATO
 STIFF PAINTED PU/LOIRA VELVET/CHROMED STEEL

Moon



A13
 NERO/BLU SCURO/CROMO
 BLACK/DARK BLUE/CHROME

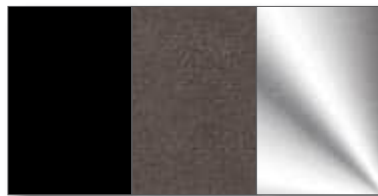

A25
 NERO/GRIGIO/CROMO
 BLACK/GREY/CHROME

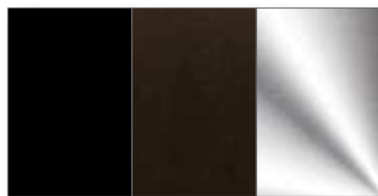

A41
 NERO/MARRONE SCURO/CROMO
 BLACK/DARK BROWN/CHROME



A31
 NERO/GRIGIO GHIACCIO/CROMO
 BLACK/ICE GREY/CHROME

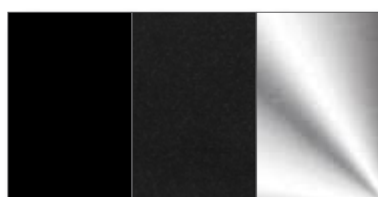

A35
 NERO/GRIGIO SCURO/CROMO
 BLACK/DARK GREY/CHROME



A43
 NERO/NERO/CROMO
 BLACK/BLACK/CHROME

CAT.C

867 VELLUTO LOIRA/ACCIAIO CROMATO
LOIRA VELVET/CHROMED STEEL

Cocky



C36
AVORIO/CROMO
IVORY/CHROME



H10
VIOLA SCURO/CROMO
DARK VIOLET/CHROME



C59
SABBIA/CROMO
SAND/CHROME



H26
VERDE/CROMO
GREEN/CHROME



E86
TORTORA/CROMO
TAUPE/CHROME



C63
VERDE SCURO/CROMO
DARK GREEN/CHROME



H27
ROSA/CROMO
PINK/CHROME



C56
PETROLIO/CROMO
PETROL GREEN/CHROME



C58
ROSSO/CROMO
RED/CHROME



H89
BLU MEDIO/CROMO
MEDIUM BLUE/CHROME



H90
ROSSO SCURO/CROMO
DARK RED/CHROME



E88
BLU NOTTE/CROMO
NIGHT BLUE/CHROME



C41
BORDEAUX/CROMO
BURGUNDY/CHROME



C40
BLU/CROMO
BLUE/CHROME

CAT.C

866 VELLUTO LOIRA/ACCIAIO CROMATO
 LOIRA VELVET/CHROMED STEEL

Cocky



F61
 BLU SCURO/CROMO
 DARK BLUE/CHROME

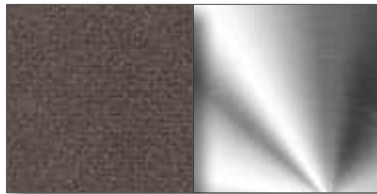

C48
 GRIGIO/CROMO
 GREY/CHROME



C53
 MARRONE SCURO/CROMO
 DARK BROWN/CHROME



H61
 GRIGIO GHIACCIO/CROMO
 ICE GREY/CHROME



C47
 GRIGIO SCURO/CROMO
 DARK GREY/CHROME



B01
 NERO/CROMO
 BLACK/CHROME

CAT.C

036 MISTO LINO LISBONA - LINEN MIX LISBONA

Composizione/Composition: 72% LI, 14% CO, 14% VI. Altezza/Height: 140 cm. Peso/Weight: 735gr. Abrasione/Abrasion: 25.000 Martindale (uso pubblico, uso regolare/public use, regular use).



002
BIANCO
WHITE



011
SABBIA
SAND

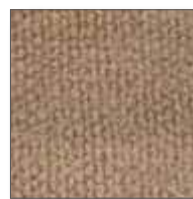

078
NOCCIOLA
HAZEL

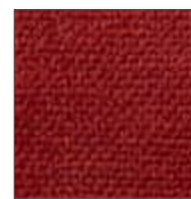

039
ROSSO
RED

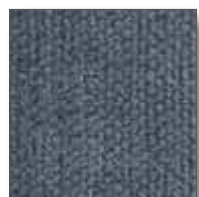

060
AZZURRO
LIGHT BLUE



062
VERDE CHIARO
LIGHT GREEN



066
VERDE SCURO
DARK GREEN



072
BLU
BLUE



069
PETROLIO
PETROL GREEN



045
GRIGIO CHIARO
LIGHT GREY



050
GRIGIO SCURO
DARK GREY



091
NERO
BLACK

I colori sono indicativi. Non è possibile garantire uniformità di tono nella tintura dei lotti di tessuto. Resta inteso che lievi differenze di colore verranno accettate al momento dell'ordine.

The colors are just indicative. Actually a steady tone of lots cannot be

CAT.C

065 MISTO LINO LISBONA/FRASSINO - *LINEN MIX LISBONA/ASH*

La Francesea



177
BIANCO/NATURALE
WHITE/NATURAL



182
BLU/NATURALE
BLUE/NATURAL



221
SABBIA/NATURALE
SAND/NATURAL



212
PETROLIO/NATURALE
PETROL GREEN/NATURAL



210
NOCCIOLA/NATURALE
HAZEL/NATURAL



197
GRIGIO CHIARO/NATURALE
LIGHT GREY/NATURAL



219
ROSSO/NATURALE
RED/NATURAL

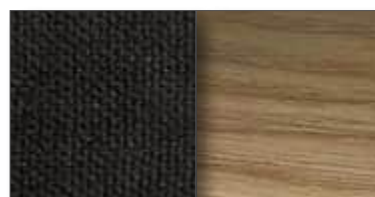

191
GRIGIO SCURO/NATURALE
DARK GREY/NATURAL



175
AZZURRO/NATURALE
LIGHT BLUE/NATURAL

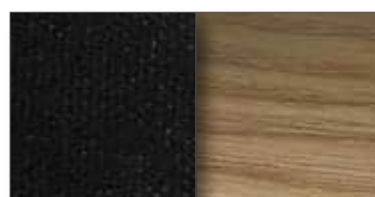

207
NERO/NATURALE
BLACK/NATURAL

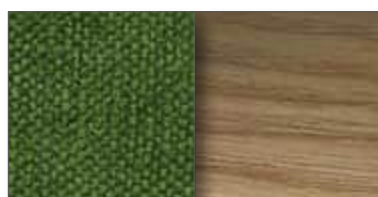

226
VERDE CHIARO/NATURALE
LIGHT GREEN/NATURAL



227
VERDE SCURO/NATURALE
DARK GREEN/NATURAL

CAT.C

065 MISTO LINO LISBONA/FRASSINO - LINEN MIX LISBONA/ASH

La Francese, Ten



230
BIANCO/EBANIZZATO
WHITE/EBONIZED



242
BLU/EBANIZZATO
BLUE/EBONIZED



282
SABBIA/EBANIZZATO
SAND/EBONIZED

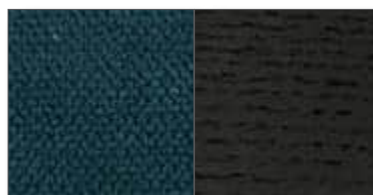

273
PETROLIO/EBANIZZATO
PETROL GREEN/EBONIZED



270
NOCCIOLA/EBANIZZATO
HAZEL/EBONIZED

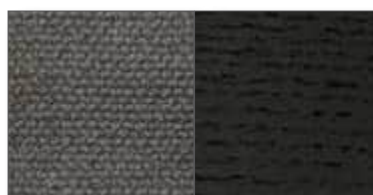

256
GRIGIO CHIARO/EBANIZZATO
LIGHT GREY/EBONIZED

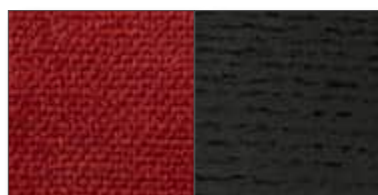

280
ROSSO/EBANIZZATO
RED/EBONIZED



260
GRIGIO SCURO/EBANIZZATO
DARK GREY/EBONIZED



236
AZZURRO/EBANIZZATO
LIGHT BLUE/EBONIZED



267
NERO/EBANIZZATO
BLACK/EBONIZED

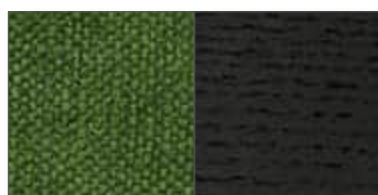

288
VERDE CHIARO/EBANIZZATO
LIGHT GREEN/EBONIZED

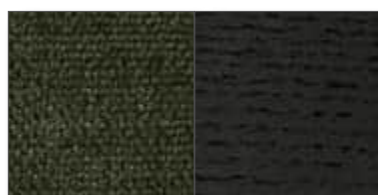

289
VERDE SCURO/EBANIZZATO
DARK GREEN/EBONIZED

CAT.C

134 MISTO LINO LISBONA/ACCIAIO VERNICIATO - LINEN MIX LISBONA/PAINTED STEEL

Sof Sof, 33 Cuscini

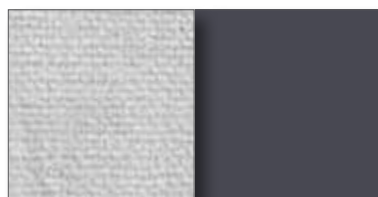

328
BIANCO/GRAFITE
WHITE/GRAPHITE



336
BLU/GRAFITE
BLUE/GRAPHITE

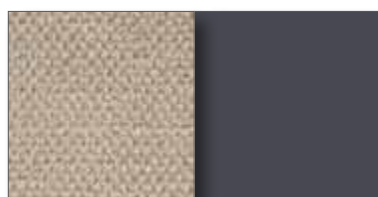

377
SABBIA/GRAFITE
SAND/GRAPHITE

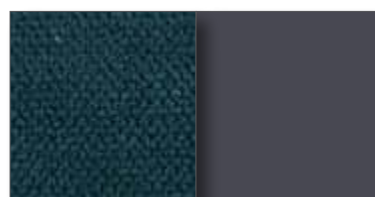

367
PETROLIO/GRAFITE
PETROL GREEN/GRAPHITE

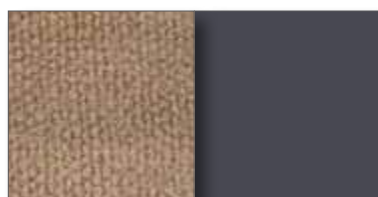

364
NOCCIOLA/GRAFITE
HAZEL/GRAPHITE

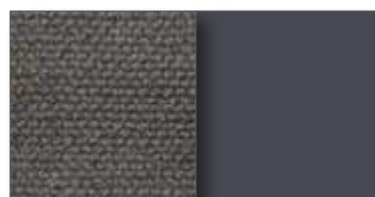

348
GRIGIO CHIARO/GRAFITE
LIGHT GREY/GRAPHITE

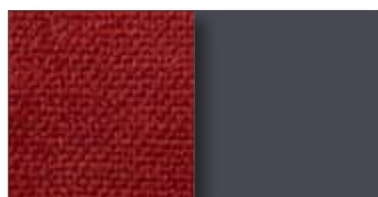

374
ROSSO/GRAFITE
RED/GRAPHITE

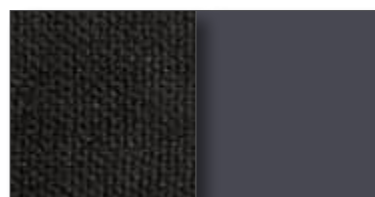

353
GRIGIO SCURO/GRAFITE
DARK GREY/GRAPHITE

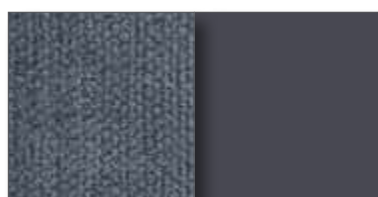

326
AZZURRO/GRAFITE
LIGHT BLUE/GRAPHITE



361
NERO/GRAFITE
BLACK/GRAPHITE

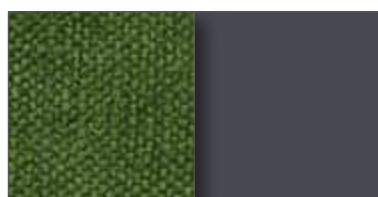

380
VERDE CHIARO/GRAFITE
LIGHT GREEN/GRAPHITE

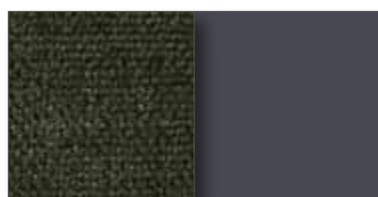

384
VERDE SCURO/GRAFITE
DARK GREEN/GRAPHITE

CAT.C

134 MISTO LINO LISBONA/ACCIAIO VERNICIATO - LINEN MIX LISBONA/PAINTED STEEL

Fenix



442
BIANCO/PELTRO BRONZATO
WHITE/BRONZE PEWTER



450
BLU/PELTRO BRONZATO
BLUE/BRONZE PEWTER



498
SABBIA/PELTRO BRONZATO
SAND/BRONZE PEWTER



486
PETROLIO/PELTRO BRONZATO
PETROL GREEN/BRONZE PEWTER



482
NOCCIOLA/PELTRO BRONZATO
HAZEL/BRONZE PEWTER

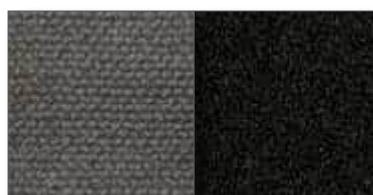

466
GRIGIO CHIARO/PELTRO BRONZATO
LIGHT GREY/BRONZE PEWTER

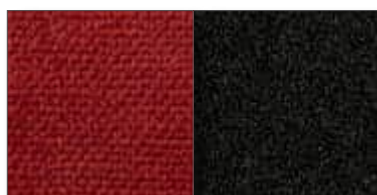

494
ROSSO/PELTRO BRONZATO
RED/BRONZE PEWTER



471
GRIGIO SCURO/PELTRO BRONZATO
DARK GREY/BRONZE PEWTER



440
AZZURRO/PELTRO BRONZATO
LIGHT BLUE/BRONZE PEWTER



479
NERO/PELTRO BRONZATO
BLACK/BRONZE PEWTER



104
VERDE CHIARO/PELTRO BRONZATO
LIGHT GREEN/BRONZE PEWTER



507
VERDE SCURO/PELTRO BRONZATO
DARK GREEN/BRONZE PEWTER

CAT.C

134 MISTO LINO LISBONA/ACCIAIO VERNICIATO - LINEN MIX LISBONA/PAINTED STEEL

Elisa



393
BIANCO/NERO MARRONE
WHITE/BLACK BROWN

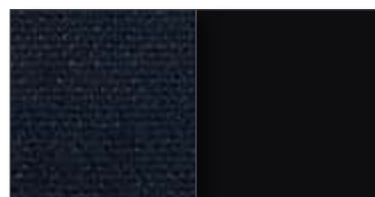

400
BLU/NERO MARRONE
BLUE/BLACK BROWN

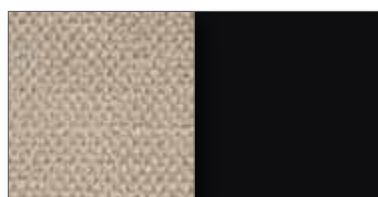

426
SABBIA/NERO MARRONE
SAND/BLACK BROWN

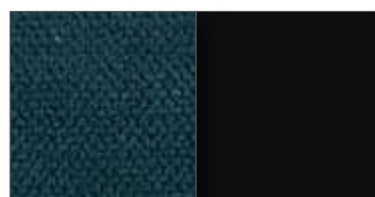

419
PETROLIO/NERO MARRONE
PETROL GREEN/BLACK BROWN

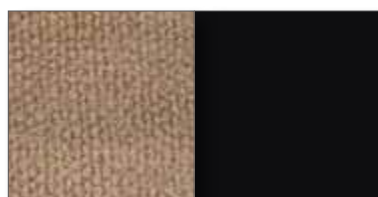

117
NOCCIOLA/NERO MARRONE
HAZEL/BLACK BROWN



407
GRIGIO CHIARO/NERO MARRONE
LIGHT GREY/BLACK BROWN

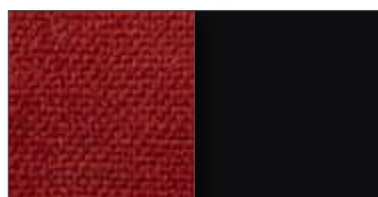

424
ROSSO/NERO MARRONE
RED/BLACK BROWN

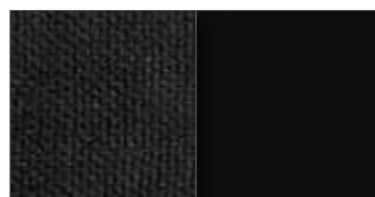

411
GRIGIO SCURO/NERO MARRONE
DARK GREY/BLACK BROWN

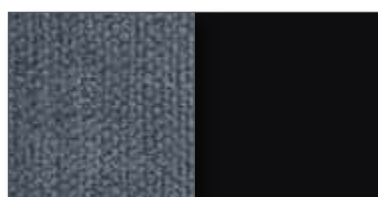

391
AZZURRO/NERO MARRONE
LIGHT BLUE/BLACK BROWN



417
NERO/NERO MARRONE
BLACK/BLACK BROWN

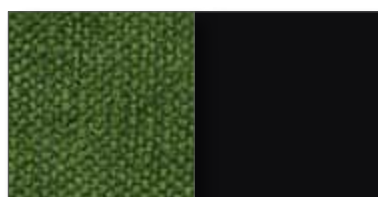

429
VERDE CHIARO/NERO MARRONE
LIGHT GREEN/BLACK BROWN

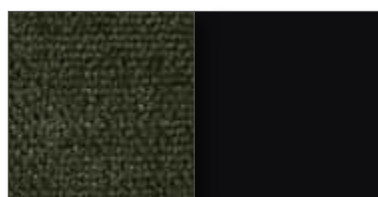

432
VERDE SCURO/NERO MARRONE
DARK GREEN/BLACK BROWN

CAT.C

134 MISTO LINO LISBONA/ACCIAIO VERNICIATO - LINEN MIX LISBONA/PAINTED STEEL

Cocky



596
BIANCO/NERO
WHITE/BLACK



604
BLU/NERO
BLUE/BLACK



651
SABBIA/NERO
SAND/BLACK



639
PETROLIO/NERO
PETROL GREEN/BLACK



635
NOCCIOLA/NERO
HAZEL/BLACK

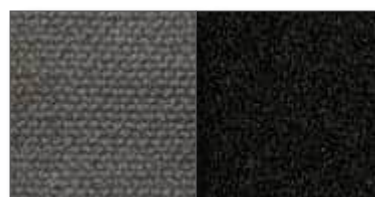

620
GRIGIO CHIARO/NERO
LIGHT GREY/BLACK



647
ROSSO/NERO
RED/BLACK



625
GRIGIO SCURO/NERO
DARK GREY/BLACK



594
AZZURRO/NERO
LIGHT BLUE/BLACK



632
NERO/NERO
BLACK/BLACK



657
VERDE CHIARO/NERO
LIGHT GREEN/BLACK



661
VERDE SCURO/NERO
DARK GREEN/BLACK

CAT.C

199 MISTO LINO LISBONA/ALLUMINIO LUCIDATO - LINEN MIX LISBONA/POLISHED ALUMINUM

Lou Speak, Cocky

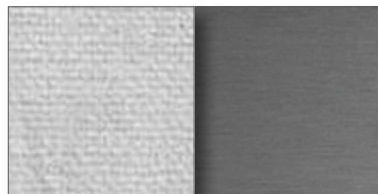

531
BIANCO/ALLUMINIO
WHITE/ALUMINUM

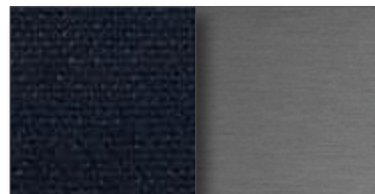

536
BLU/ALLUMINIO
BLUE/ALUMINUM

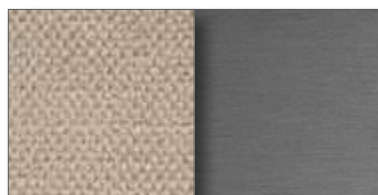

578
SABBIA/ALLUMINIO
SAND/ALUMINUM

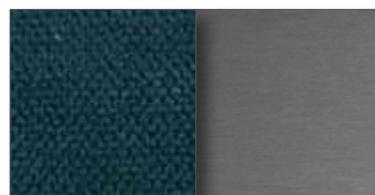

568
PETROLIO/ALLUMINIO
PETROL GREEN/ALUMINUM

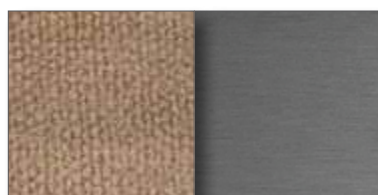

564
NOCCIOLA/ALLUMINIO
HAZEL/ALUMINUM

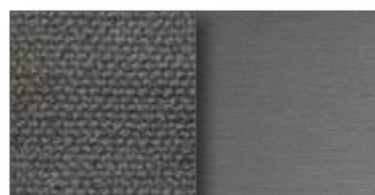

550
GRIGIO CHIARO/ALLUMINIO
LIGHT GREY/ALUMINUM

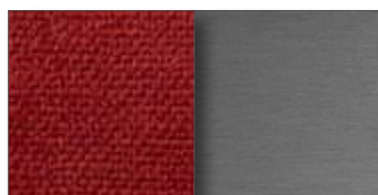

575
ROSSO/ALLUMINIO
RED/ALUMINUM

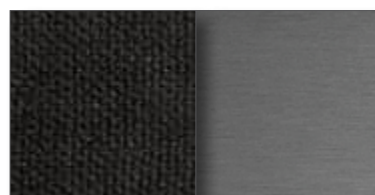

554
GRIGIO SCURO/ALLUMINIO
DARK GREY/ALUMINUM

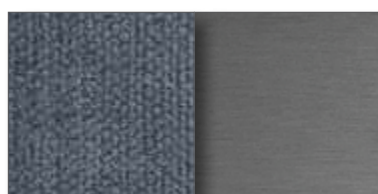

529
AZZURRO/ALLUMINIO
LIGHT BLUE/ALUMINUM



561
NERO/ALLUMINIO
BLACK/ALUMINUM

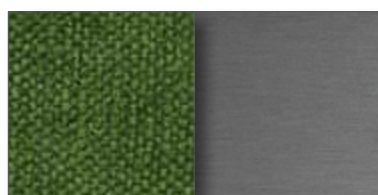

584
VERDE CHIARO/ALLUMINIO
LIGHT GREEN/ALUMINUM

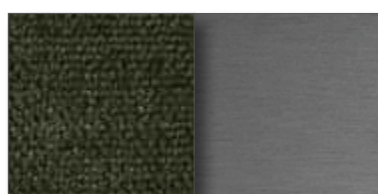

585
VERDE SCURO/ALLUMINIO
DARK GREEN/ALUMINUM

CAT.C

228 MISTO LINO LISBONA/ALLUMINIO VERNICIATO - LINEN MIX LISBONA/PAINTED ALUMINUM

Lirica, Lirico



596
BIANCO/NERO
WHITE/BLACK



604
BLU/NERO
BLUE/BLACK

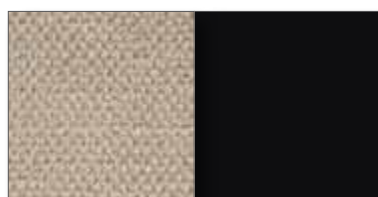

651
SABBIA/NERO
SAND/BLACK

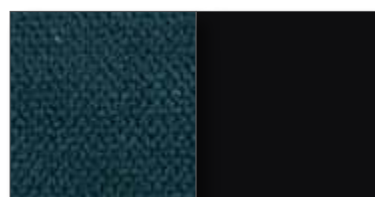

639
PETROLIO/NERO
PETROL GREEN/BLACK

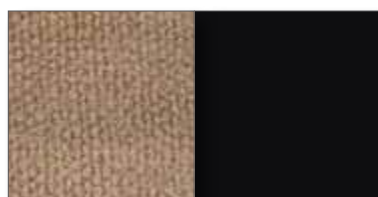

635
NOCCIOLA/NERO
HAZEL/BLACK



620
GRIGIO CHIARO/NERO
LIGHT GREY/BLACK

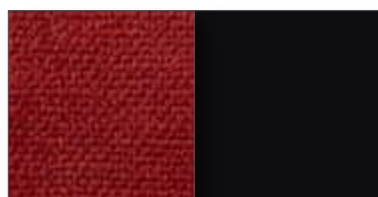

647
ROSSO/NERO
RED/BLACK

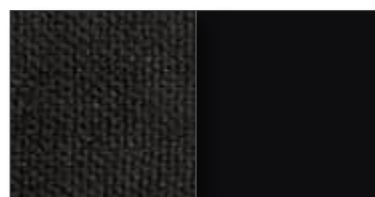

625
GRIGIO SCURO/NERO
DARK GREY/BLACK

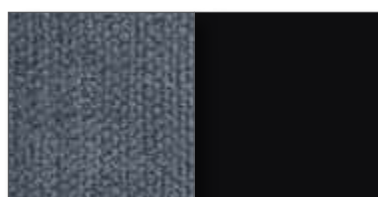

594
AZZURRO/NERO
LIGHT BLUE/BLACK



632
NERO/NERO
BLACK/BLACK

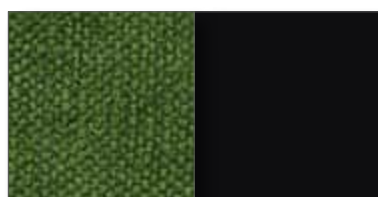

657
VERDE CHIARO/NERO
LIGHT GREEN/BLACK

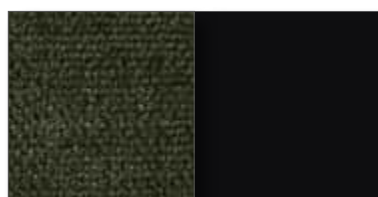

661
VERDE SCURO/NERO
DARK GREEN/BLACK

CAT.C

228 MISTO LINO LISBONA/ALLUMINIO VERNICIATO - LINEN MIX LISBONA/PAINTED ALUMINUM

Leeon Soft



442
BIANCO/PELTRO BRONZATO
WHITE/BRONZE PEWTER



450
BLU/PELTRO BRONZATO
BLUE/BRONZE PEWTER



498
SABBIA/PELTRO BRONZATO
SAND/BRONZE PEWTER

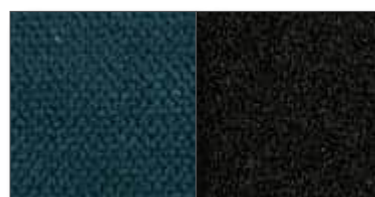

486
PETROLIO/PELTRO BRONZATO
PETROL GREEN/BRONZE PEWTER



482
NOCCIOLA/PELTRO BRONZATO
HAZEL/BRONZE PEWTER

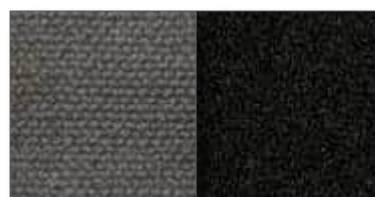

466
GRIGIO CHIARO/PELTRO BRONZATO
LIGHT GREY/BRONZE PEWTER



494
ROSSO/PELTRO BRONZATO
RED/BRONZE PEWTER



471
GRIGIO SCURO/PELTRO BRONZATO
DARK GREY/BRONZE PEWTER



440
AZZURRO/PELTRO BRONZATO
LIGHT BLUE/BRONZE PEWTER



479
NERO/PELTRO BRONZATO
BLACK/BRONZE PEWTER



104
VERDE CHIARO/PELTRO BRONZATO
LIGHT GREEN/BRONZE PEWTER



507
VERDE SCURO/PELTRO BRONZATO
DARK GREEN/BRONZE PEWTER

CAT.C

228 MISTO LINO LISBONA/ALLUMINIO VERNICIATO - LINEN MIX LISBONA/PAINTED ALUMINUM

Lirica, Lirico



722
BIANCO/ARGENTO
WHITE/SILVER



730
BLU/ARGENTO
BLUE/SILVER



778
SABBIA/ARGENTO
SAND/SILVER



766
PETROLIO/ARGENTO
PETROL GREEN/SILVER



762
NOCCIOLA/ARGENTO
HAZEL/SILVER



746
GRIGIO CHIARO/ARGENTO
LIGHT GREY/SILVER



774
ROSSO/ARGENTO
RED/SILVER



751
GRIGIO SCURO/ARGENTO
DARK GREY/SILVER



720
AZZURRO/ARGENTO
LIGHT BLUE/SILVER



759
NERO/ARGENTO
BLACK/SILVER



784
VERDE CHIARO/ARGENTO
LIGHT GREEN/SILVER



788
VERDE SCURO/ARGENTO
DARK GREEN/SILVER

CAT.C

321 MISTO LINO LISBONA/FAGGIO LACCATO - LINEN MIX LISBONA/LACQUERED BEECH

S.Marco, S.Marco Lounge



596
BIANCO/NERO
WHITE/BLACK



604
BLU/NERO
BLUE/BLACK

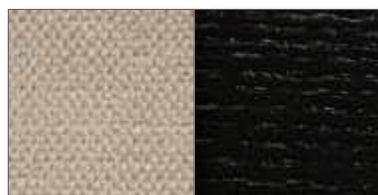

651
SABBIA/NERO
SAND/BLACK

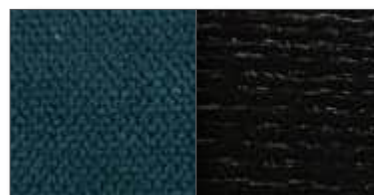

639
PETROLIO/NERO
PETROL GREEN/BLACK



635
NOCCIOLA/NERO
HAZEL/BLACK

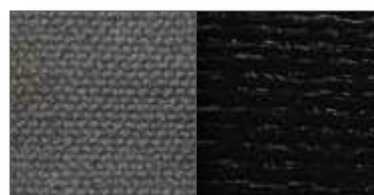

620
GRIGIO CHIARO/NERO
LIGHT GREY/BLACK

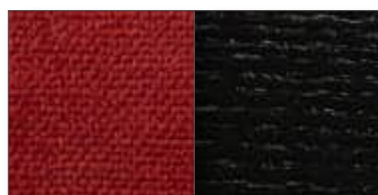

647
ROSSO/NERO
RED/BLACK



625
GRIGIO SCURO/NERO
DARK GREY/BLACK



594
AZZURRO/NERO
LIGHT BLUE/BLACK



632
NERO/NERO
BLACK/BLACK

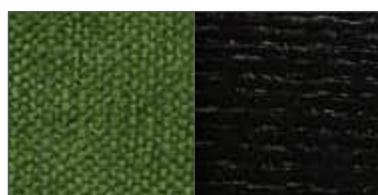

657
VERDE CHIARO/NERO
LIGHT GREEN/BLACK

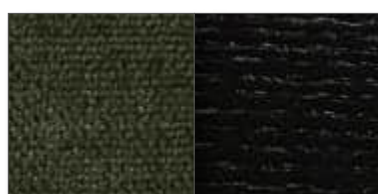

661
VERDE SCURO/NERO
DARK GREEN/BLACK

CAT.C

403 PU RIGIDO VERNICIATO/MISTO LINO LISBONA/ACCIAIO CROMATO
 STIFF PAINTED PU/LINEN MIX LISBONA/CHROMED STEEL

Moon



864
 MATTONE/BIANCO/CROMO
 RED BRICK/WHITE/CHROME

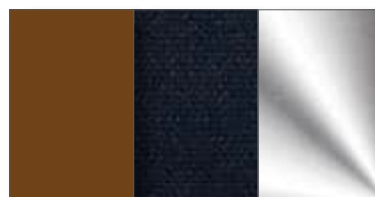

871
 MATTONE/BLU/CROMO
 RED BRICK/BLUE/CHROME



917
 MATTONE/SABBIA/CROMO
 RED BRICK/SAND/CHROME



905
 MATTONE/PETROLIO/CROMO
 RED BRICK/PETROL GREEN/CHROME



902
 MATTONE/NOCCIOLA/CROMO
 RED BRICK/HAZEL/CHROME

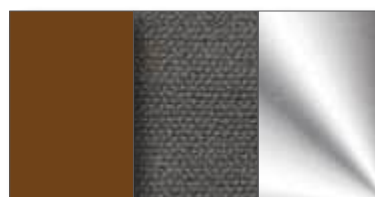

886
 MATTONE/GRIGIO CHIARO/CROMO
 RED BRICK/LGHT GREY/CHROME

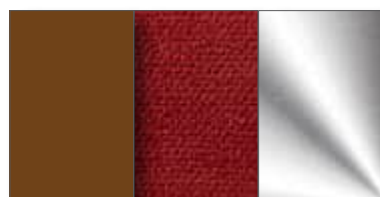

913
 MATTONE/ROSSO/CROMO
 RED BRICK/RED/CHROME

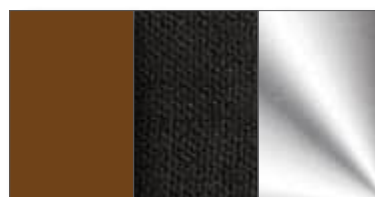

891
 MATTONE/GRIGIO SCURO/CROMO
 RED BRICK/DARK GREY/CHROME

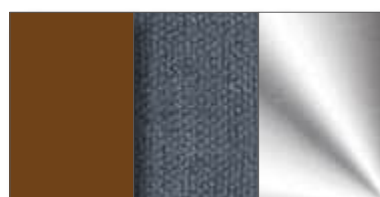

862
 MATTONE/AZZURRO/CROMO
 RED BRICK/LIGHT BLUE/CHROME

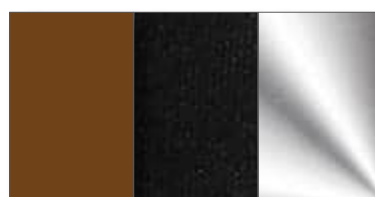

899
 MATTONE/NERO/CROMO
 RED BRICK/BLACK/CHROME



922
 MATTONE/VERDE CHIARO/CROMO
 RED BRICK/LIGHT GREEN/CHROME

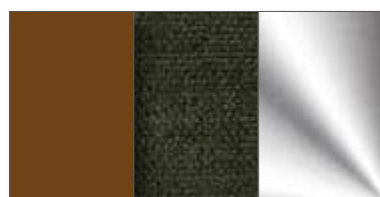

926
 MATTONE/VERDE SCURO/CROMO
 RED BRICK/DARK GREEN/CHROME

CAT.C

403 PU RIGIDO VERNICIATO/MISTO LINO LISBONA/ACCIAIO CROMATO
STIFF PAINTED PU/LINEN MIX LISBONA/CHROMED STEEL

Moon



936
ECRU/BIANCO/CROMO
ECRU/WHITE/CHROME

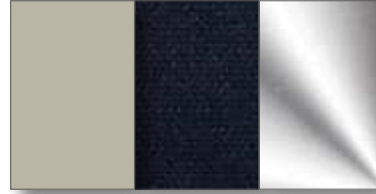

943
ECRU/BLU/CROMO
ECRU/BLUE/CHROME



989
ECRU/SABBIA/CROMO
ECRU/SAND/CHROME

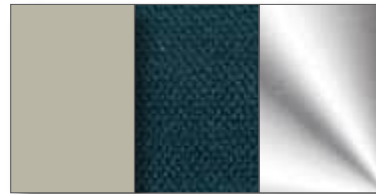

977
ECRU/PETROLIO/CROMO
ECRU/PETROL GREEN/CHROME

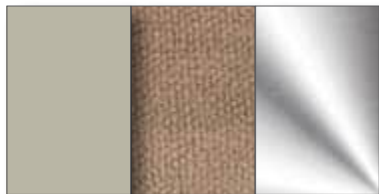

974
ECRU/NOCCIOLA/CROMO
ECRU/HAZEL/CHROME

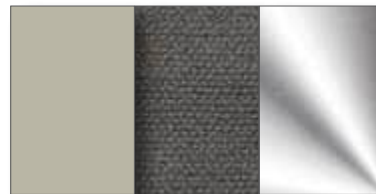

958
ECRU/GRIGIO CHIARO/CROMO
ECRU/LIGHT GREY/CHROME

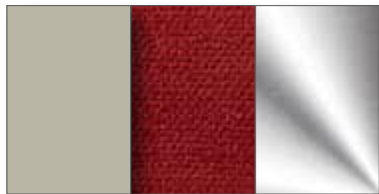

985
ECRU/ROSSO/CROMO
ECRU/RED/CHROME

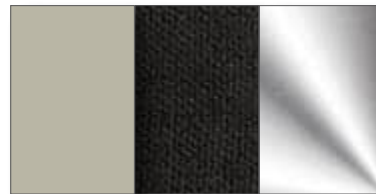

963
ECRU/GRIGIO SCURO/CROMO
ECRU/DARK GREY/CHROME

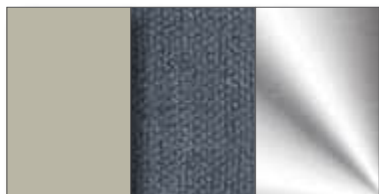

934
ECRU/AZZURRO/CROMO
ECRU/LIGHT BLUE/CHROME

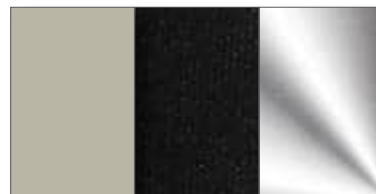

971
ECRU/NERO/CROMO
ECRU/BLACK/CHROME

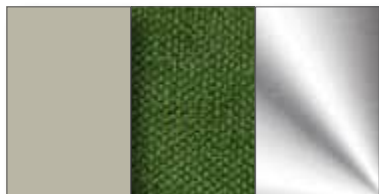

994
ECRU/VERDE CHIARO/CROMO
ECRU/LIGHT GREEN/CHROME



998
ECRU/VERDE SCURO/CROMO
ECRU/DARK GREEN/CHROME

CAT.C

403 PU RIGIDO VERNICIATO/MISTO LINO LISBONA/ACCIAIO CROMATO
 STIFF PAINTED PU/LINEN MIX LISBONA/CHROMED STEEL

Moon

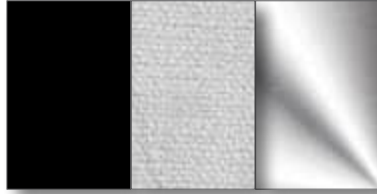

A08
 NERO/BIANCO/CROMO
 BLACK/WHITE/CHROME



A15
 NERO/BLU/CROMO
 BLACK/BLUE/CHROME

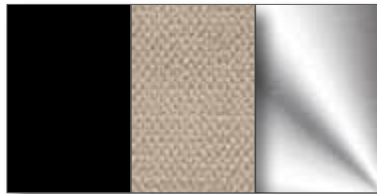

A61
 NERO/SABBIA/CROMO
 BLACK/SAND/CHROME

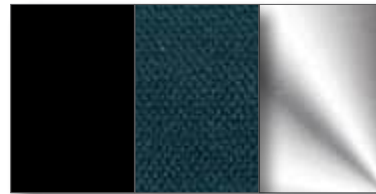

A4
 NERO/PETROLIO/CROMO
 BLACK/PETROL GREEN/CHROME

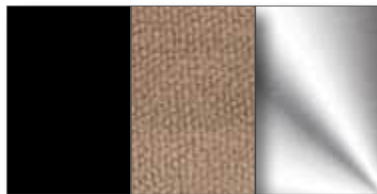

A46
 NERO/NOCCIOLA/CROMO
 BLACK/HAZEL/CHROME

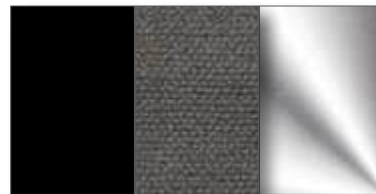

A30
 NERO/GRIGIO CHIARO/CROMO
 BLACK/LIGHT GREY/CHROME

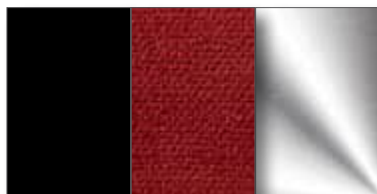

A57
 NERO/ROSSO/CROMO
 BLACK/RED/CHROME

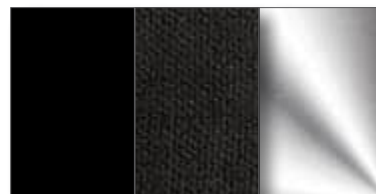

A35
 NERO/GRIGIO SCURO/CROMO
 BLACK/DARK GREY/CHROME

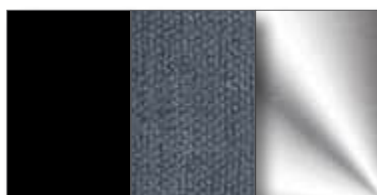

A06
 NERO/AZZURRO/CROMO
 BLACK/LIGHT BLUE/CHROME



A43
 NERO/NERO/CROMO
 BLACK/BLACK/CHROME

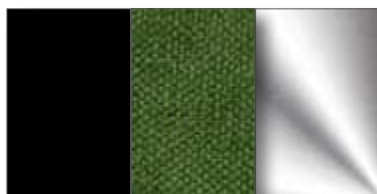

A66
 NERO/VERDE CHIARO/CROMO
 BLACK/LIGHT GREEN/CHROME

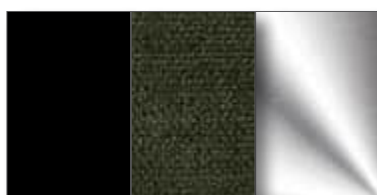

A70
 NERO/VERDE SCURO/CROMO
 BLACK/DARK GREEN/CHROME

CAT.C

866 MISTO LINO LISBONA/ACCIAIO CROMATO
LINEN MIX LISBONA/CHROMED STEEL

Cocky



B00
 BIANCO/CROMO
 WHITE/CHROME



C40
 BLU/CROMO
 BLUE/CHROME



C59
 SABBIA/CROMO
 SAND/CHROME



C56
 PETROLIO/CROMO
 PETROL GREEN/CHROME



H50
 NOCCIOLA/CROMO
 HAZEL/CHROME

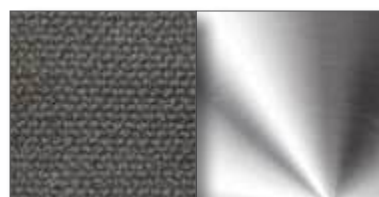

C51
 GRIGIO CHIARO/CROMO
 LIGHT GREY/CHROME



C58
 ROSSO/CROMO
 RED/CHROME



C47
 GRIGIO SCURO/CROMO
 DARK GREY/CHROME



C37
 AZZURRO/CROMO
 LIGHT BLUE/CHROME



B01
 NERO/CROMO
 BLACK/CHROME



H29
 VERDE CHIARO/CROMO
 LIGHT GREEN/CHROME

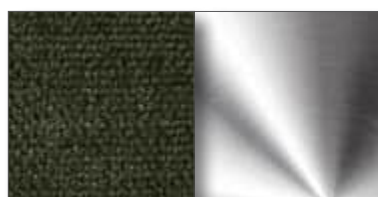

C63
 VERDE SCURO/CROMO
 DARK GREEN/CHROME

CAT.C

709 POLIPROPILENE AMBURGO - *POLYPROPYLENE AMBURGO*

Composizione/Composition: 100% PP. Altezza/Height: 140 cm. Peso/Weight: 1050 gr. Abrasione/Abrasion: 40.000 Martindale (uso pubblico, uso molto intensivo/public use, very intensive use). CAL117, BS5852 Cigaret test



002
BIANCO
WHITE



011
SABBIA
SAND

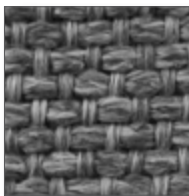

045
GRIGIO CHIARO
LIGHT GREY

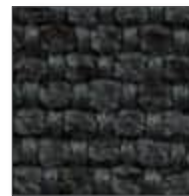

073
BLU SCURO
DARK BLUE



057
ANTRACITE
ANTHRACITE

I colori sono indicativi. Non è possibile garantire uniformità di tono nella tintura dei lotti di tessuto. Resta inteso che lievi differenze di colore verranno accettate al momento dell'ordine.

The colors are just indicative. Actually a steady tone of lots cannot be guaranteed. It remains understood that any slight colour difference will be accepted in case an order is placed.

CAT.C

785 POLIPROPILENE AMBURGO/ACCIAIO VERNICIATO - POLYPROPYLENE AMBURGO/PAINTED STEEL

Sof Sof, 33 Cuscini

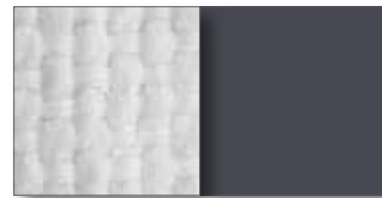

328
BIANCO/GRAFITE
WHITE/GRAPHITE

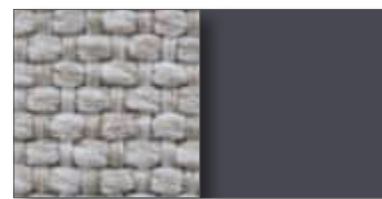

377
SABBIA/GRAFITE
SAND/GRAPHITE

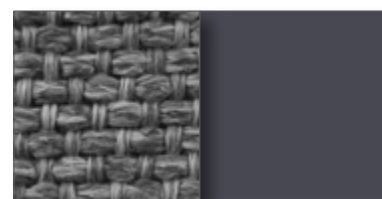

348
GRIGIO CHIARO/GRAFITE
LIGHT GREY/GRAPHITE

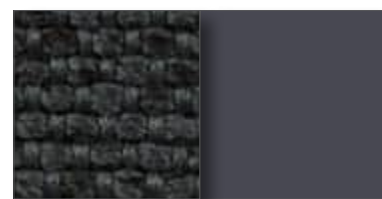

334
BLU SCURO/GRAFITE
DARK GREY/GRAPHITE

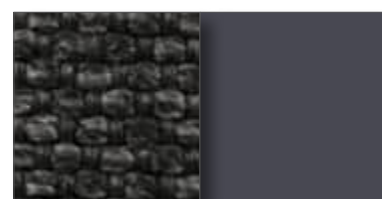

344
ANTRACITE/GRAFITE
ANTHRACITE/GRAPHITE

Elisa



393
BIANCO/NERO MARRONE
WHITE/BLACK BROWN

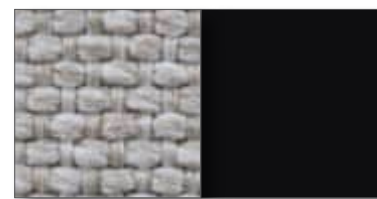

426
SABBIA/NERO MARRONE
SAND/BLACK BROWN

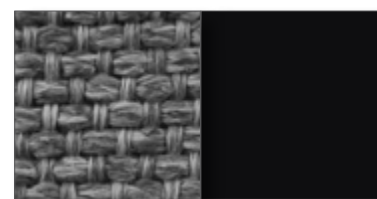

407
GRIGIO CHIARO/NERO MARRONE
LIGHT GREY/BLACK BROWN

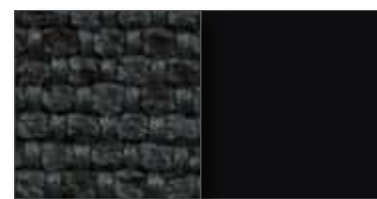

398
BLU SCURO/NERO MARRONE
DARK GREY/BLACK BROWN

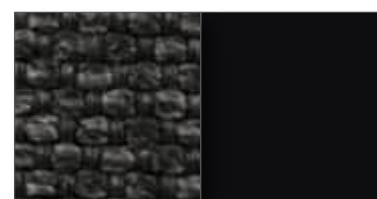

G59
ANTRACITE/NERO MARRONE
ANTHRACITE/BLACK BROWN

CAT.C

785 POLIPROPILENE AMBURGO/ACCIAIO VERNICIATO - POLYPROPYLENE AMBURGO/PAINTED STEEL

Fenix



442
BIANCO/PELTRO BRONZATO
WHITE/BRONZE PEWTER



498
SABBIA/PELTRO BRONZATO
SAND/BRONZE PEWTER



466
GRIGIO CHIARO/PELTRO BRONZATO
LIGHT GREY/BRONZE PEWTER

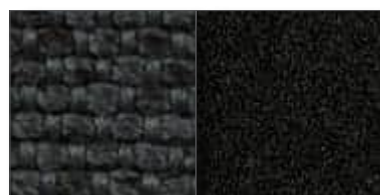

448
BLU SCURO/PELTRO BRONZATO
DARK BLUE/BRONZE PEWTER



462
ANTRACITE/PELTRO BRONZATO
ANTHRACITE/BRONZE PEWTER

Cocky



596
BIANCO/NERO
WHITE/BLACK



651
SABBIA/NERO
SAND/BLACK



620
GRIGIO CHIARO/NERO
LIGHT GREY/BLACK



602
BLU SCURO/NERO
DARK BLUE/BLACK



616
ANTRACITE/NERO
ANTHRACITE/BLACK

CAT.C

786 POLIPROPILENE AMBURGO/ALLUMINIO LUCIDATO - POLYPROPYLENE AMBURGO/POLISHED ALUMINUM

Cocky



531
BIANCO/ALLUMINIO
WHITE/ALUMINUM



578
SABBIA/ALLUMINIO
SAND/ALUMINUM

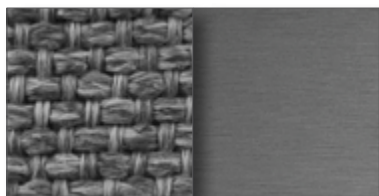

550
GRIGIO CHIARO/ALLUMINIO
LIGHT GREY/ALUMINUM

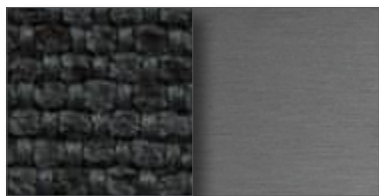

534
BLU SCURO/ALLUMINIO
DARK BLUE/ALUMINUM

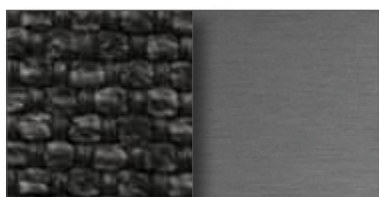

546
ANTRACITE/ALLUMINIO
ANTHRACITE/ALUMINUM

CAT.C

787 POLIPROPILENE AMBURGO/ALLUMINIO VERNICIATO - POLYPROPYLENE AMBURGO/PAINTED ALUMINUM

Lirica, Lirico

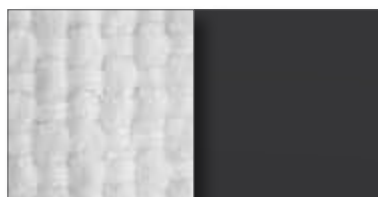

596
BIANCO/NERO
WHITE/BLACK



722
BIANCO/ARGENTO
WHITE/SILVER

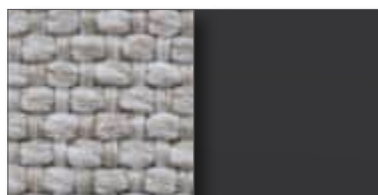

651
SABBIA/NERO
SAND/BLACK



778
SABBIA/ARGENTO
SAND/SILVER

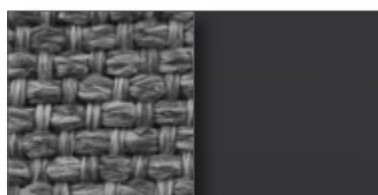

620
GRIGIO CHIARO/NERO
LIGHT GREY/BLACK

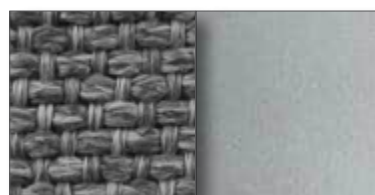

746
GRIGIO CHIARO/ARGENTO
LIGHT GREY/SILVER

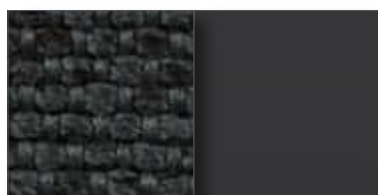

602
BLU SCURO/NERO
DARK BLUE/BLACK



728
BLU SCURO/ARGENTO
DARK BLUE/SILVER

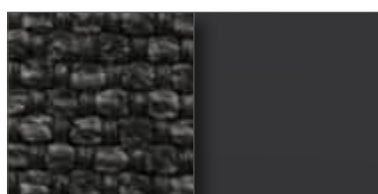

616
ANTRACITE/NERO
ANTHRACITE/BLACK



742
ANTRACITE/ARGENTO
ANTHRACITE/SILVER

CAT.C

790 POLIPROPILENE AMBURGO/FAGGIO LACCATO - POLYPROPYLENE AMBURGO/LACQUERED BEECH

S.Marco, S.Marco Lounge



596
BIANCO/NERO
WHITE|BLACK



651
SABBIA/NERO
SAND|BLACK



620
GRIGIO CHIARO/NERO
LIGHT GREY|BLACK



602
BLU SCURO/NERO
DARK GREY|BLACK



616
ANTRACITE/NERO
ANTHRACITE|BLACK

CAT.C

791 PU RIGIDO VERNICIATO/POLIPROPILENE AMBURGO/ACCIAIO CROMATO
STIFF PAINTED PU/POLYPROPYLENE AMBURGO/CHROMED STEEL

Moon

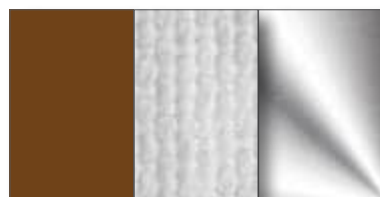

864
MATTONE/BIANCO/CROMO
BRICK RED/WHITE/CHROME



936
ECRU'/BIANCO/CROMO
BRICK RED/BIANCO/CHROME

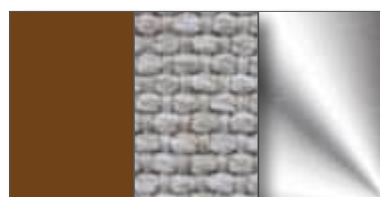

917
MATTONE/SABBIA/CROMO
BRICK RED/SAND/CHROME

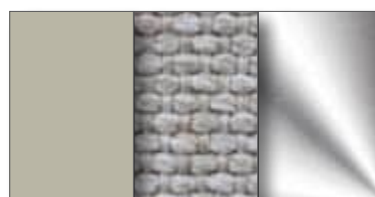

989
ECRU'/SABBIA/CROMO
BRICK RED/SAND/CHROME

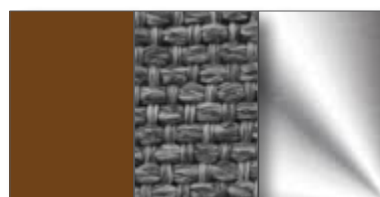

886
MATTONE/GRIGIO CHIARO/CROMO
BRICK RED/LIGHT GREY/CHROME

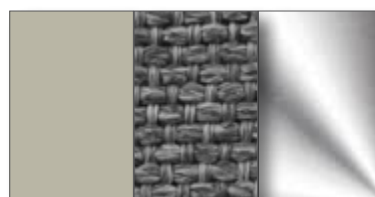

958
ECRU'/GRIGIO CHIARO/CROMO
BRICK RED/LIGHT GREY/CHROME

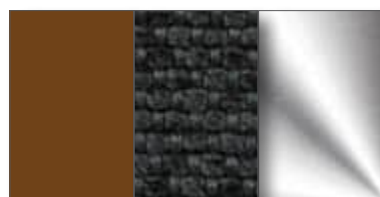

869
MATTONE/BLU SCURO/CROMO
BRICK RED/DARK BLUE/CHROME

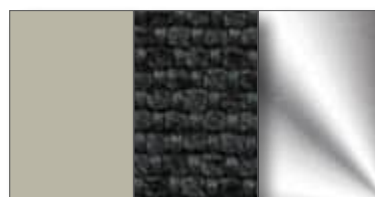

941
ECRU'/BLU SCURO/CROMO
BRICK RED/DARK BLUE/CHROME

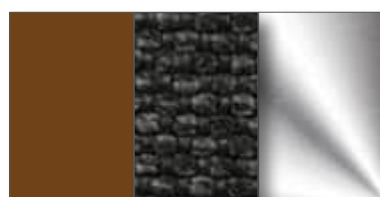

882
MATTONE/ANTRACITE/CROMO
BRICK RED/ANTHRACITE/CHROME

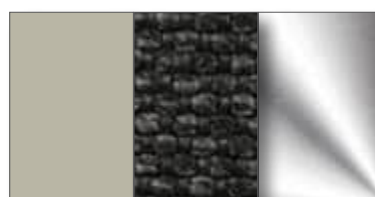

H99
ECRU'/ANTRACITE/CROMO
BRICK RED/ANTHRACITE/CHROME

CAT.C

791 PU RIGIDO VERNICIATO/POLIPROPILENE AMBURGO/ACCIAIO CROMATO
STIFF PAINTED PU/POLYPROPYLENE AMBURGO/CHROMED STEEL

Moon

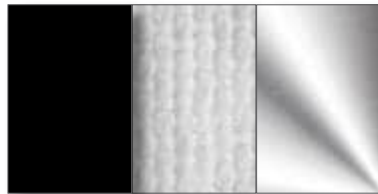

A08
NERO/BIANCO/CROMO
BLACK/WHITE/CHROME

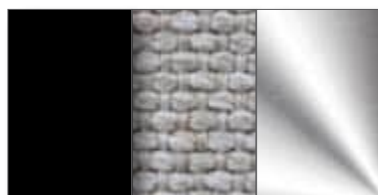

954
NERO/SABBIA/CROMO
BLACK/SAND/CHROME

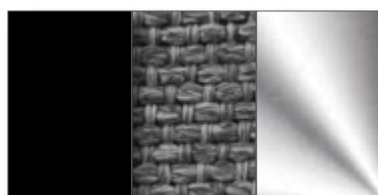

A30
NERO/GRIGIO CHIARO/CROMO
BLACK/LIGHT GREY/CHROME

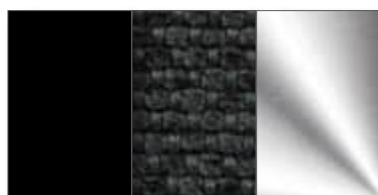

A13
NERO/BLU SCURO/CROMO
BLACK/DARK BLUE/CHROME

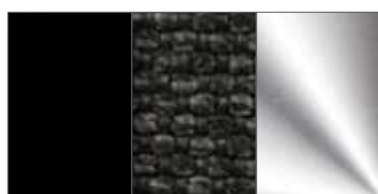

A26
NERO/ANTRACITE/CROMO
BLACK/ANTHRACITE/CHROME

CAT.C

875 POLIPROPILENE AMBURGO/ACCIAIO CROMATO
POLYPROPYLENE AMBURGO/CHROMED STEEL

Cocky

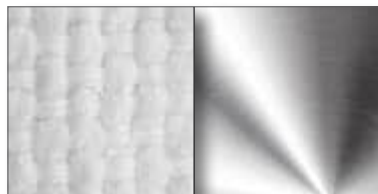

B00
BIANCO/CROMO
WHITE/CHROME



C59
SABBIA/CROMO
SAND/CHROME

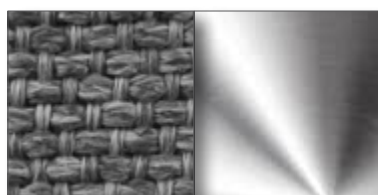

C51
GRIGIO CHIARO/CROMO
LIGHT GREY/CHROME

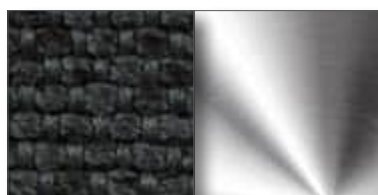

F61
BLU SCURO/CROMO
DARK BLUE/CHROME



I14
ANTRACITE/CROMO
ANTHRACITE/CHROME

CAT.C

710 MISTO POLIESTERE BERNA - *MIXED POLYESTER BERNA*

Composizione/Composition: 29% PL, 29% PC, 21% CO, 15% WO, 6% VI. Altezza/Height: 140 cm. Peso/Weight: 820gr. Abrasione/Abrasion: 40.000 Martindale (uso pubblico, uso molto intensivo/public use, very intensive use). CAL117, BS5852 Cigaret test

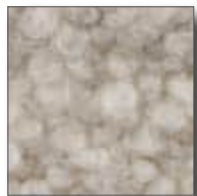

002
BIANCO
WHITE



011
SABBIA
SAND

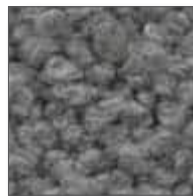

045
GRIGIO CHIARO
LIGHT GREY



091
NERO
BLACK

I colori sono indicativi. Non è possibile garantire uniformità di tono nella tintura dei lotti di tessuto. Resta inteso che lievi differenze di colore verranno accettate al momento dell'ordine.

The colors are just indicative. Actually a steady tone of lots cannot be guaranteed. It remains understood that any slight colour difference will be accepted in case an order is placed.

CAT.C

794 MISTO POLIESTERE BERNA/ACCIAIO VERNICIATO - MIXED POLYESTER BERNA/PAINTED STEEL

Sof Sof, 33 Cuscini

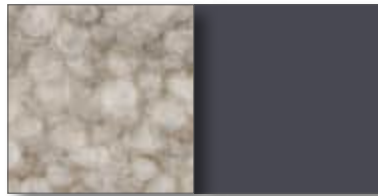

328
BIANCO/GRAFITE
WHITE/GRAPHITE

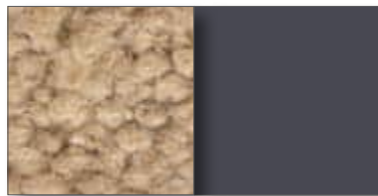

377
SABBIA/GRAFITE
SAND/GRAPHITE

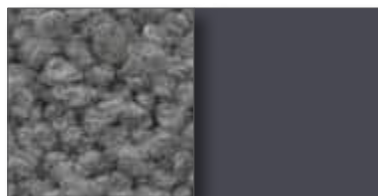

348
GRIGIO CHIARO/GRAFITE
LIGHT GREY/GRAPHITE

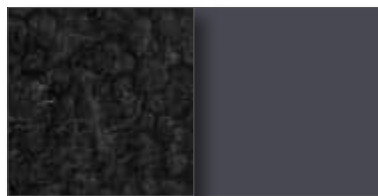

361
NERO/GRAFITE
BLACK/GRAPHITE

Elisa

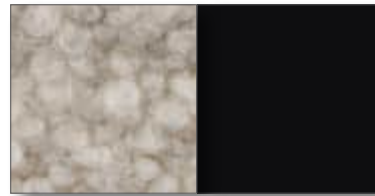

393
BIANCO/NERO MARRONE
WHITE/BLACK BROWN

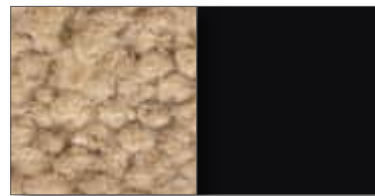

426
SABBIA/NERO MARRONE
SAND/BLACK BROWN

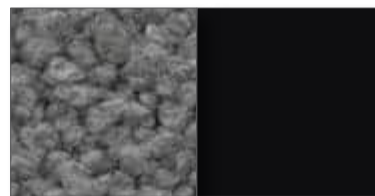

407
GRIGIO CHIARO/NERO MARRONE
LIGHT GREY/BLACK BROWN

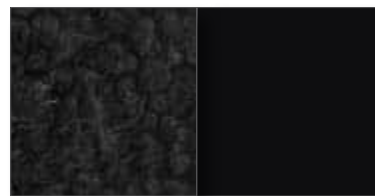

417
NERO/NERO MARRONE
BLACK/BLACK BROWN

CAT.C

794 MISTO POLIESTERE BERNA/ACCIAIO VERNICIATO - MIXED POLYESTER BERNA/PAINTED STEEL

Fenix

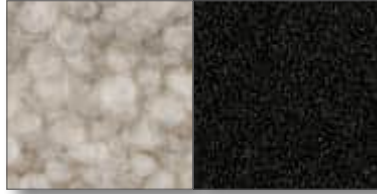

442
BIANCO/PELTRO BRONZATO
WHITE/BRONZE PEWTER



498
SABBIA/PELTRO BRONZATO
SAND/BRONZE PEWTER

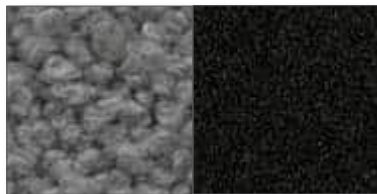

466
GRIGIO CHIARO/PELTRO BRONZATO
LIGHT GREY/BRONZE PEWTER



479
NERO/PELTRO BRONZATO
BLACK/BRONZE PEWTER

Cocky

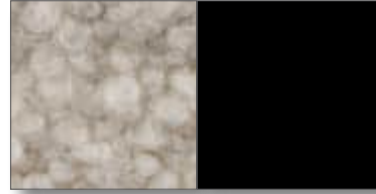

596
BIANCO/NERO
WHITE/BLACK

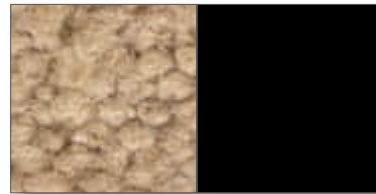

651
SABBIA/NERO
SAND/BLACK

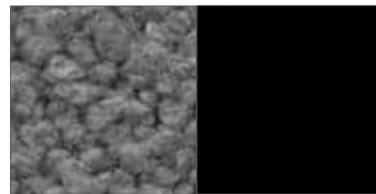

620
GRIGIO CHIARO/NERO
LIGHT GREY/BLACK

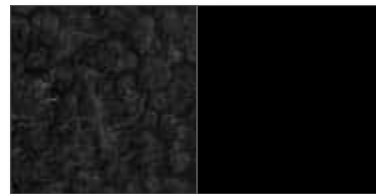

632
NERO/NERO
BLACK/BLACK

CAT.C

795 MISTO POLIESTERE BERNA/ALLUMINIO LUCIDATO -
MIXED POLYESTER BERNA/POLISHED ALUMINUM

Lou Speak, Cocky

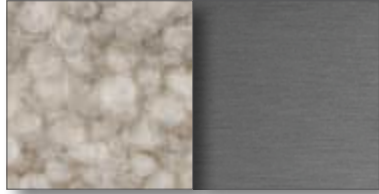

531
BIANCO/ALLUMINIO
WHITE/ALUMINUM

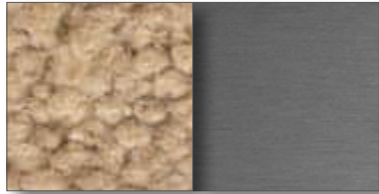

578
SABBIA/ALLUMINIO
SAND/ALUMINUM

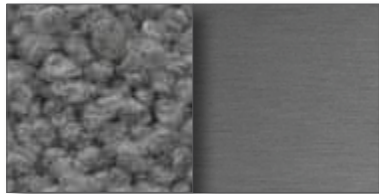

550
GRIGIO CHIARO/ALLUMINIO
LIGHT GREY/ALUMINUM

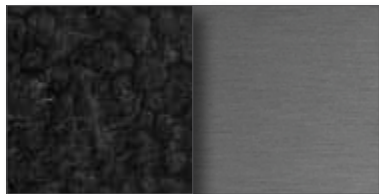

561
NERO/ALLUMINIO
BLACK/ALUMINUM

CAT.C

830 MISTO POLIESTERE BERNA/ALLUMINIO VERNICIATO -
MIXED POLYESTER BERNA/PAINTED ALUMINUM

Lirica, Lirico



596
BIANCO/NERO
WHITE/BLACK



722
BIANCO/ARGENTO
WHITE/SILVER

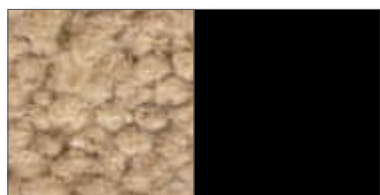

651
SABBIA/NERO
SAND/BLACK



778
SABBIA/ARGENTO
SAND/SILVER



620
GRIGIO CHIARO/NERO
LIGHT GREY/BLACK



746
GRIGIO CHIARO/ARGENTO
LIGHT GREY/SILVER



632
NERO/NERO
BLACK/BLACK



759
NERO/ARGENTO
BLACK/SILVER

CAT.C

800 PU RIGIDO VERNICIATO/MISTO POLIESTERE BERNA/ACCIAIO CROMATO
 STIFF PAINTED PU/MIXED POLYESTER BERNA/CHROMED STEEL

Moon

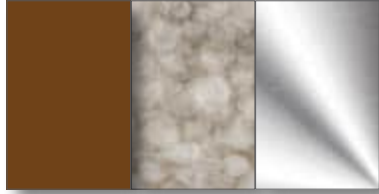

864
 MATTONE/BIANCO/CROMO
 RED BRICK/WHITE/CHROME

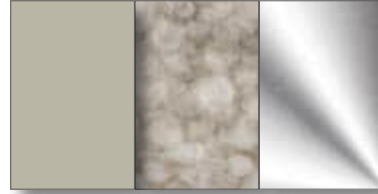

936
 ECRU'/BIANCO/CROMO
 ECRU'/WHITE/CHROME

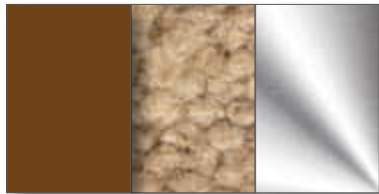

917
 MATTONE/SABBIA/CROMO
 RED BRICK/SAND/CHROME

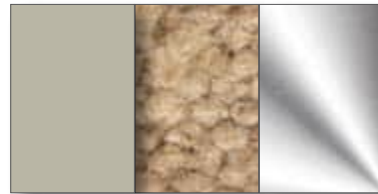

989
 ECRU'/SABBIA/CROMO
 ECRU'/SAND/CHROME

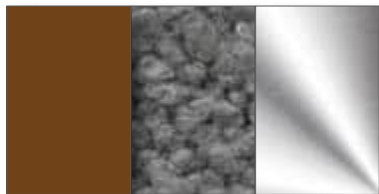

886
 MATTONE/GRIGIO CHIARO/CROMO
 RED BRICK/LIGHT GREY/CHROME



958
 ECRU'/GRIGIO CHIARO/CROMO
 ECRU'/LIGHT GREY/CHROME

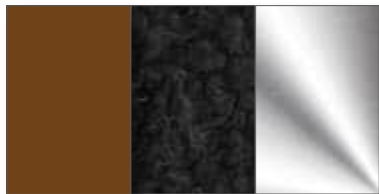

899
 MATTONE/NERO/CROMO
 RED BRICK/BLACK/CHROME

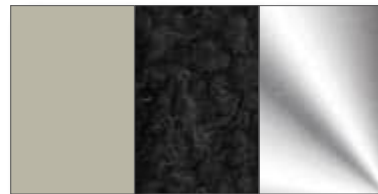

971
 ECRU'/NERO/CROMO
 ECRU'/BLACK/CHROME

CAT.C

800 PU RIGIDO VERNICIATO/MISTO POLIESTERE BERNA/ACCIAIO CROMATO
STIFF PAINTED PU/MIXED POLYESTER BERNA/CHROMED STEEL

Moon

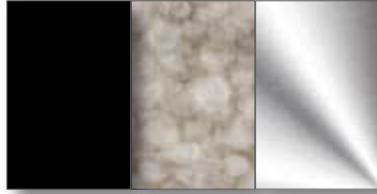

A08
NERO/BIANCO/CROMO
BLACK/WHITE/CHROME

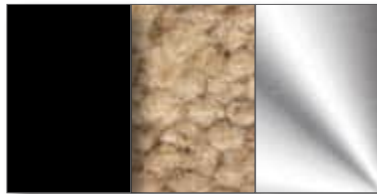

954
NERO/SABBIA/CROMO
BLACK/SAND/CHROME

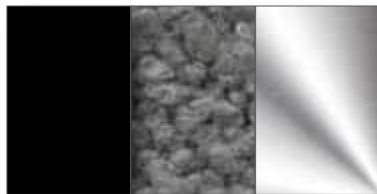

A30
NERO/GRIGIO CHIARO/CROMO
BLACK/LIGHT GREY/CHROME

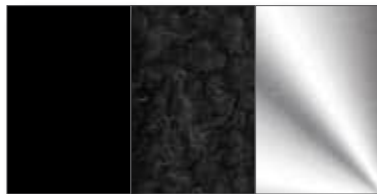

A43
NERO/NERO/CROMO
BLACK/NERO/CHROME

CAT.C

876 PMISTO POLIESTERE BERNA/ACCIAIO CROMATO
MIXED POLYESTER BERNA/CHROMED STEEL

Cocky



B00
BIANCO/CROMO
WHITE/CHROME

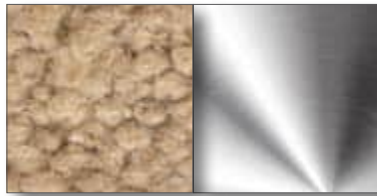

C59
SABBIA/CROMO
SAND/CHROME

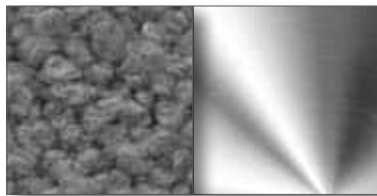

C51
GRIGIO CHIARO/CROMO
LIGHT GREY/CHROME

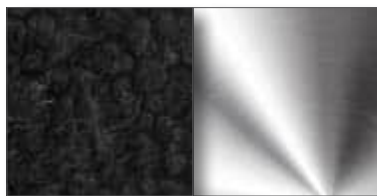

B01
NERO/CROMO
BLACK/CHROME

CAT.C

040 LINO BARCELLONA - LINEN BARCELLONA

Composizione/Composition: 100% L. Altezza/Height: 138/140 cm. Peso/Weight: 680gr. Abrasione/Abrasion: 30.000 Martindale (uso pubblico, uso intensivo/public use, intensive use).
BS5852:0 1979 ign cigarette test pass



004
AVORIO
IVORY



011
SABBIA
SAND

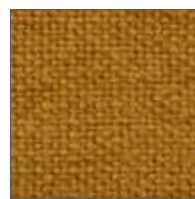

020
GIALLO SENAPE
MUSTARD YELLOW



024
ROSA
PINK

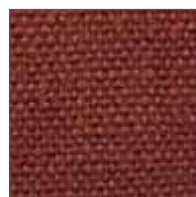

036
ROSSO ANTICO
ANTIQUE RED

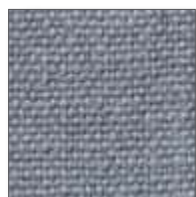

060
AZZURRO
LIGHT BLUE



072
BLU
BLUE



066
VERDE SCURO
DARK GREEN



080
MARRONE CHIARO
LIGHT BROWN



083
MARRONE SCURO
DARK BROWN



045
GRIGIO CHIARO
LIGHT GREY



050
GRIGIO SCURO
DARK GREY

I colori sono indicativi. Non è possibile garantire uniformità di tono nella tintura dei lotti di tessuto. Resta inteso che lievi differenze di colore verranno accettate al momento dell'ordine.

The colors are just indicative. Actually a steady tone of lots cannot be guaranteed. It remains understood that any slight colour difference will be accepted in case an order is placed.

CAT.C

138 LINO BARCELLONA/ACCIAIO VERNICIATO - LINEN BARCELLONA/PAINTED STEEL

Sof Sof, 33 Cuscini

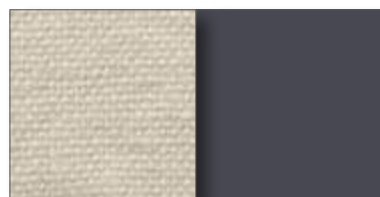

322
AVORIO/GRAFITE
IVORY/GRAPHITE

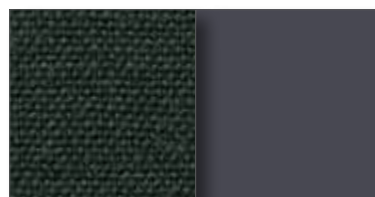

384
VERDE SCURO/GRAFITE
DARK GREEN/GRAPHITE

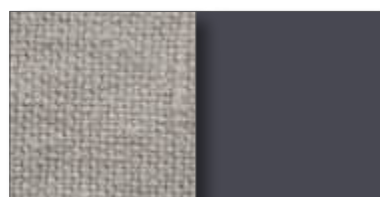

377
SABBIA/GRAFITE
SAND/GRAPHITE

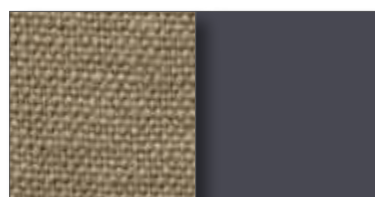

357
MARRONE CHIARO/GRAFITE
LIGHT BROWN/GRAPHITE

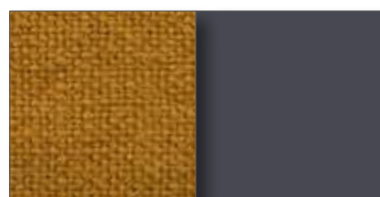

341
GIALLO SENAPE/GRAFITE
MUSTARD YELLOW/GRAPHITE

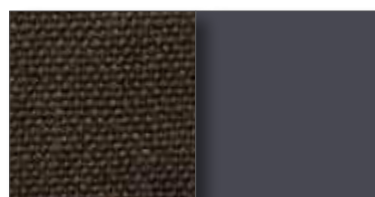

359
MARRONE SCURO/GRAFITE
DARK BROWN/GRAPHITE

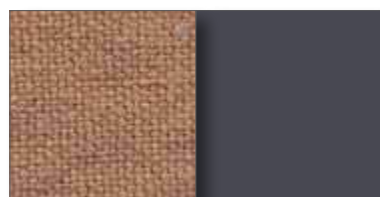

370
ROSA/GRAFITE
PINK/GRAPHITE

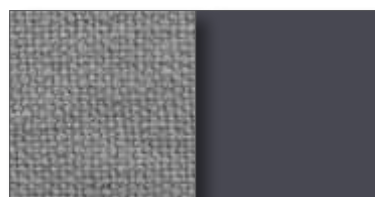

348
GRIGIO CHIARO/GRAFITE
LIGHT GREY/GRAPHITE

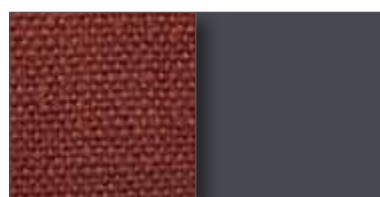

371
ROSSO ANTICO/GRAFITE
ANTIQUE RED/GRAPHITE

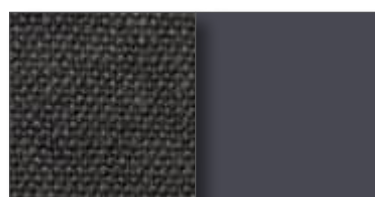

353
GRIGIO SCURO/GRAFITE
DARK GREY/GRAPHITE

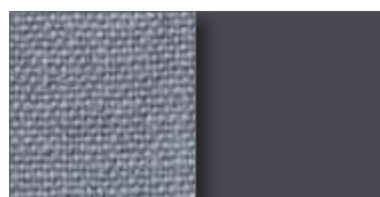

326
AZZURRO/GRAFITE
LIGHT BLUE/GRAPHITE

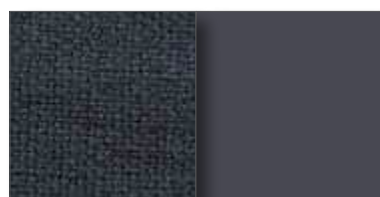

336
BLU/GRAFITE
BLUE/GRAPHITE

CAT.C

138 LINO BARCELLONA/ACCIAIO VERNICIATO - LINEN BARCELLONA/PAINTED STEEL

Elisa

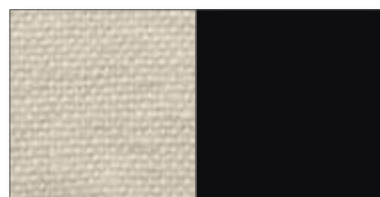

388
AVORIO/NERO MARRONE
IVORY/BLACK BROWN

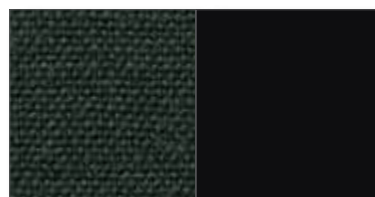

432
VERDE SCURO/NERO MARRONE
DARK GREEN/BLACK BROWN

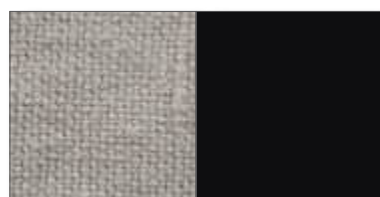

426
SABBIA/NERO MARRONE
SAND/BLACK BROWN

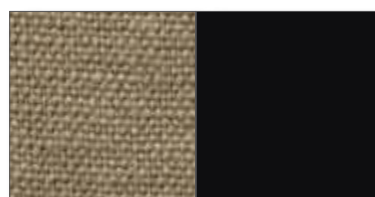

414
MARRONE CHIARO/NERO MARRONE
LIGHT BROWN/BLACK BROWN

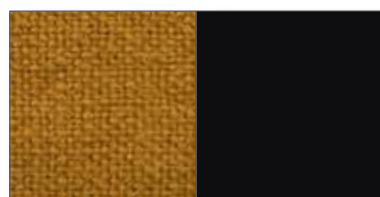

110
GIALLO SENAPE/NERO MARRONE
MUSTARD YELLOW/BLACK BROWN

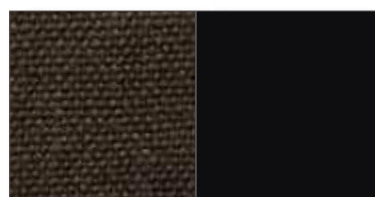

415
MARRONE SCURO/NERO MARRONE
DARK BROWN/BLACK BROWN

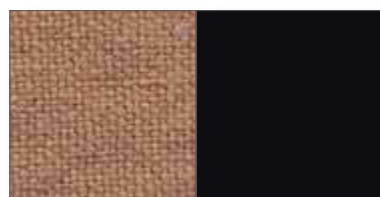

422
ROSA/NERO MARRONE
PINK/BLACK BROWN



407
GRIGIO CHIARO/NERO MARRONE
LIGHT GREY/BLACK BROWN

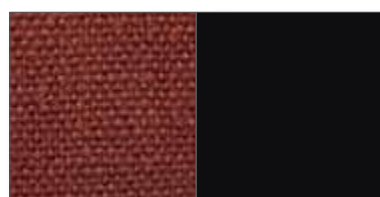

109
ROSSO ANTICO/NERO MARRONE
ANTIQUE RED/BLACK BROWN

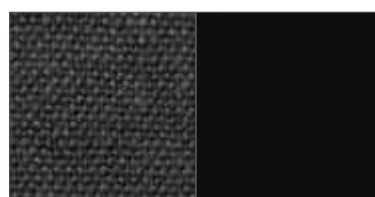

411
GRIGIO SCURO/NERO MARRONE
DARK GREY/BLACK BROWN

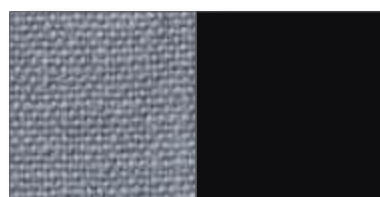

391
AZZURRO/NERO MARRONE
LIGHT BLUE/BLACK BROWN



400
BLU/NERO MARRONE
BLUE/BLACK BROWN

CAT.C

138 LINO BARCELLONA/ACCIAIO VERNICIATO - LINEN BARCELONA/PAINTED STEEL

Fenix



436
AVORIO/PELTRO BRONZATO
IVORY/BRONZE PEWTER



507
VERDE SCURO/PELTRO BRONZATO
DARK GREEN/BRONZE PEWTER



498
SABBIA/PELTRO BRONZATO
SAND/BRONZE PEWTER



475
MARRONE CHIARO/PELTRO BRONZATO
LIGHT BROWN/BRONZE PEWTER



459
GIALLO SENAPE/PELTRO BRONZATO
MUSTARD YELLOW/BRONZE PEWTER

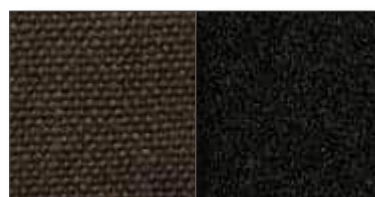

477
MARRONE SCURO/PELTRO BRONZATO
DARK BROWN/BRONZE PEWTER



490
ROSA/PELTRO BRONZATO
PINK/BRONZE PEWTER

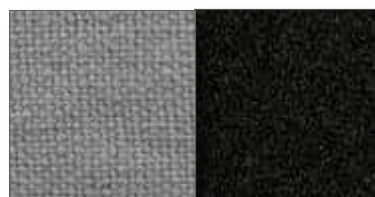

466
GRIGIO CHIARO/PELTRO BRONZATO
LIGHT GREY/BRONZE PEWTER



491
ROSSO ANTICO/PELTRO BRONZATO
ANTIQUERED/BRONZE PEWTER

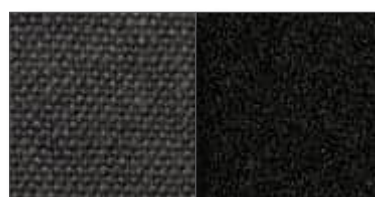

471
GRIGIO SCURO/PELTRO BRONZATO
DARK GREY/BRONZE PEWTER



440
AZZURRO/PELTRO BRONZATO
LIGHT BLUE/BRONZE PEWTER



450
BLU/PELTRO BRONZATO
BLUE/BRONZE PEWTER

CAT.C

138 LINO BARCELLONA/ACCIAIO VERNICIATO - LINEN BARCELONA/PAINTED STEEL

Cocky



590
AVORIO/NERO
IVORY/BLACK

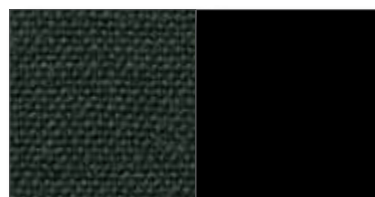

661
VERDE SCURO/NERO
DARK GREEN/BLACK



651
SABBIA/NERO
SAND/BLACK



628
MARRONE CHIARO/NERO
LIGHT BROWN/BLACK



613
GIALLO SENAPE/NERO
MUSTARD YELLOW/BLACK

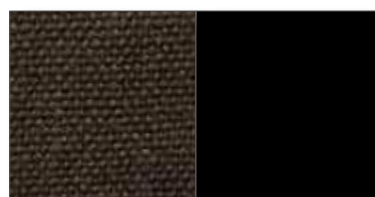

630
MARRONE SCURO/NERO
DARK BROWN/BLACK

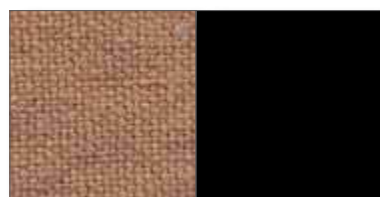

643
ROSA/NERO
PINK/BLACK

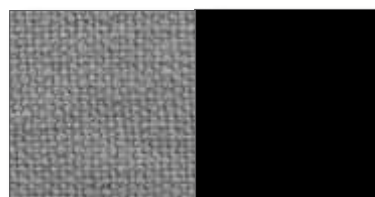

620
GRIGIO CHIARO/NERO
LIGHT GREY/BLACK

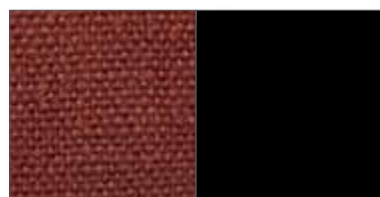

644
ROSSO ANTICO/NERO
ANTIQUE RED/BLACK

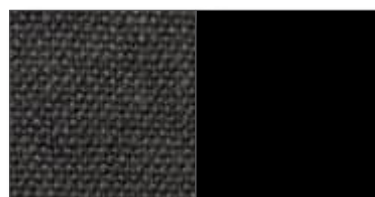

625
GRIGIO SCURO/NERO
DARK GREY/BLACK



594
AZZURRO/NERO
LIGHT BLUE/BLACK



604
BLU/NERO
BLUE/BLACK

CAT.C

883 LINO BARCELLONA/ACCIAIO CROMATO - LINEN BARCELLONA/CHROMED STEEL

Cocky

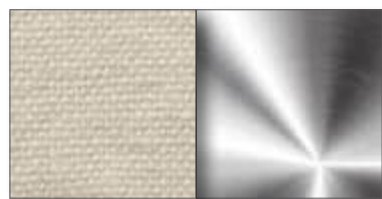

C36
AVORIO/CROMO
IVORY/CHROME

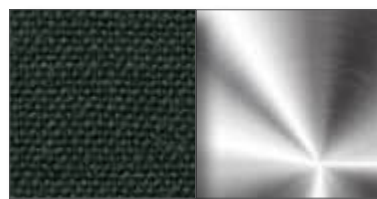

C63
VERDE SCURO/CROMO
DARK GREEN/CHROME

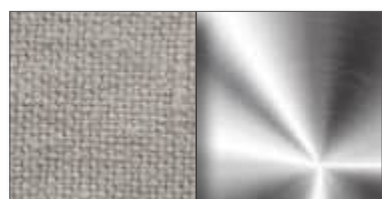

C59
SABBIA/CROMO
SAND/CHROME

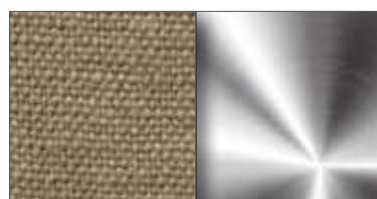

C52
MARRONE CHIARO/CROMO
LIGHT BROWN/CHROME



I12
GIALLO SENAPE/CROMO
MUSTARD YELLOW/CHROME



C53
MARRONE SCURO/CROMO
DARK BROWN/CHROME



H27
ROSA/CROMO
PINK/CHROME

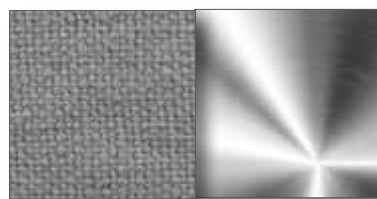

C51
GRIGIO CHIARO/CROMO
LIGHT GREY/CHROME

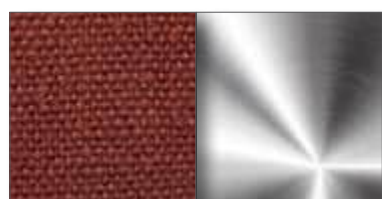

I11
ROSSO ANTICO/CROMO
ANTIQUE RED/CHROME

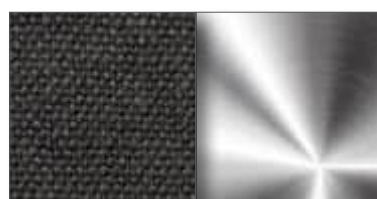

C47
GRIGIO SCURO/CROMO
DARK GREY/CHROME

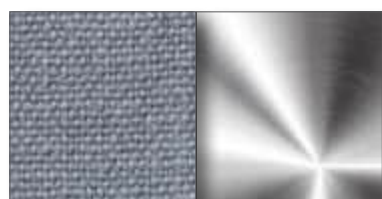

C37
AZZURRO/CROMO
LIGHT BLUE/CHROME



C40
BLU/CROMO
BLUE/CHROME

CAT.C

865 LINO BARCELLONA/ALLUMINIO LUCIDATO - LINEN BARCELONA/POLISHED ALUMINUM

Cocky

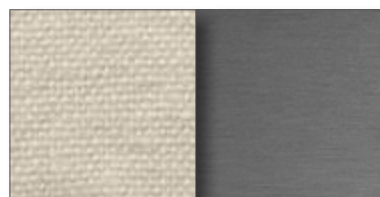

526
AVORIO/ALLUMINIO
IVORY/ALUMINUM

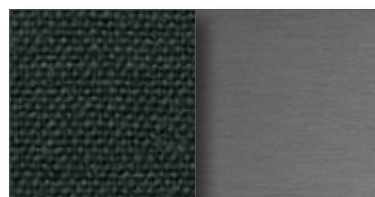

585
VERDE SCURO/ALLUMINIO
DARK GREEN/ALUMINUM

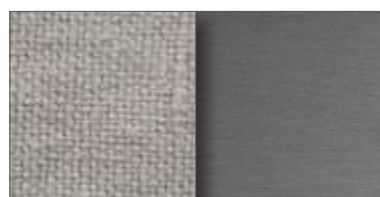

578
SABBIA/ALLUMINIO
SAND/ALUMINUM

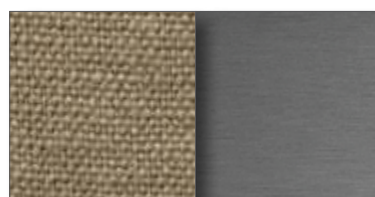

557
MARRONE CHIARO/ALLUMINIO
LIGHT BROWN/ALUMINUM

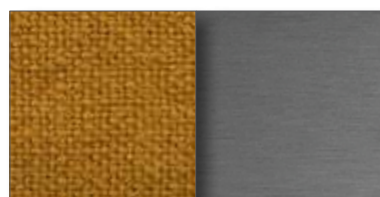

116
GIALLO SENAPE/ALLUMINIO
MUSTARD YELLOW/ALUMINUM

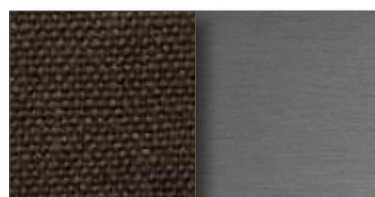

559
MARRONE SCURO/ALLUMINIO
DARK BROWN/ALUMINUM

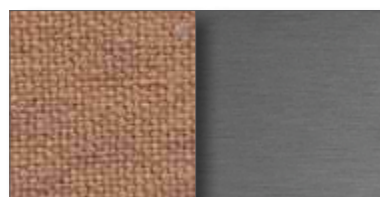

572
ROSA/ALLUMINIO
PINK/ALUMINUM

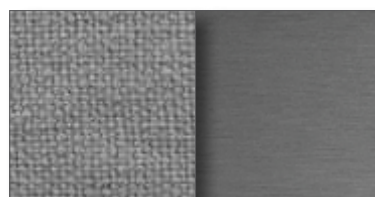

550
GRIGIO CHIARO/ALLUMINIO
LIGHT GREY/ALUMINUM

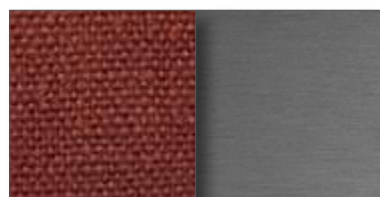

115
ROSSO ANTICO/ALLUMINIO
ANTIQUE RED/ALUMINUM

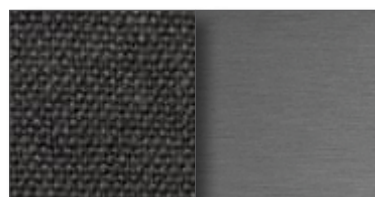

554
GRIGIO SCURO/ALLUMINIO
DARK GREY/ALUMINUM

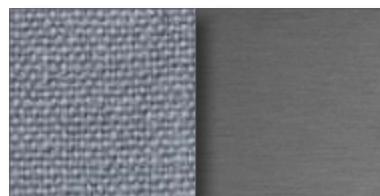

529
AZZURRO/ALLUMINIO
LIGHT BLUE/ALUMINUM



536
BLU/ALLUMINIO
BLUE/ALUMINUM

CAT.C

232 LINO BARCELLONA/ALLUMINIO VERNICIATO - *LINEN BARCELONA/PAINTED ALUMINUM*

Lirica, Lirico

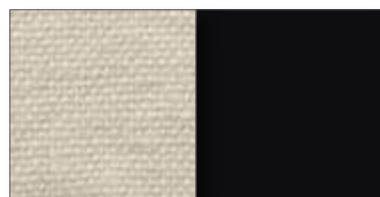

590
AVORIO/NERO
IVORY/BLACK

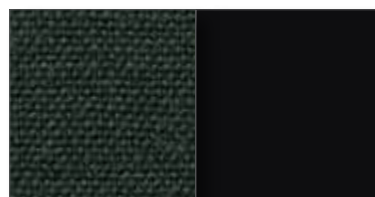

661
VERDE SCURO/NERO
DARK GREEN/BLACK

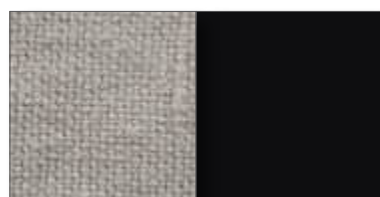

651
SABBIA/NERO
SAND/BLACK

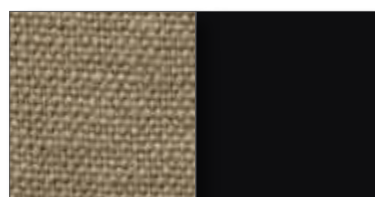

628
MARRONE CHIARO/NERO
LIGHT BROWN/BLACK

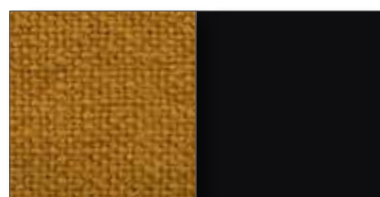

613
GIALLO SENAPE/NERO
MUSTARD YELLOW/BLACK

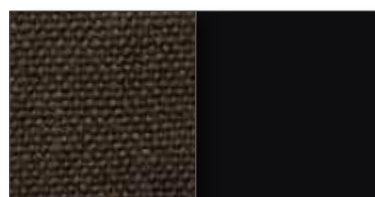

630
MARRONE SCURO/NERO
DARK BROWN/BLACK

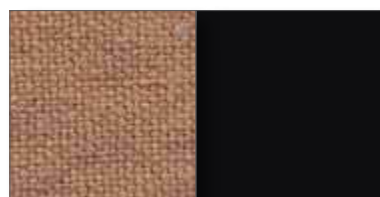

643
ROSA/NERO
PINK/BLACK



620
GRIGIO CHIARO/NERO
LIGHT GREY/BLACK

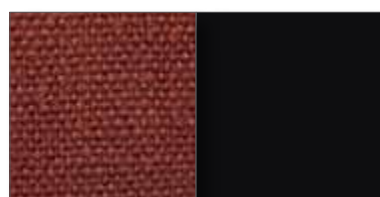

644
ROSSO ANTICO/NERO
ANTIQUÉ RED/BLACK



625
GRIGIO SCURO/NERO
DARK GREY/BLACK

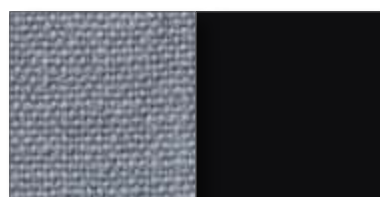

594
AZZURRO/NERO
LIGHT BLUE/BLACK

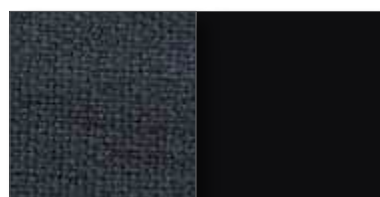

604
BLU/NERO
BLUE/BLACK

CAT.C

232 LINO BARCELLONA/ALLUMINIO VERNICIATO - *LINEN BARCELONA/PAINTED ALUMINUM*

Lirica, Lirico



716
AVORIO/ARGENTO
IVORY/SILVER



788
VERDE SCURO/ARGENTO
DARK GREEN/SILVER



778
SABBIA/ARGENTO
SAND/SILVER



755
MARRONE CHIARO/ARGENTO
LIGHT BROWN/SILVER



739
GIALLO SENAPE/ARGENTO
MUSTARD YELLOW/SILVER



757
MARRONE SCURO/ARGENTO
DARK BROWN/SILVER



770
ROSA/ARGENTO
PINK/SILVER



746
GRIGIO CHIARO/ARGENTO
LIGHT GREY/SILVER



771
ROSSO ANTICO/ARGENTO
ANTIQUE RED/SILVER



751
GRIGIO SCURO/ARGENTO
DARK GREY/SILVER



720
AZZURRO/ARGENTO
LIGHT BLUE/SILVER



730
BLU/ARGENTO
BLUE/SILVER

CAT.C

407 PU RIGIDO VERNICIATO/LINO BARCELLONA/ACCIAIO CROMATO
 STIFF PAINTED PU/*BARCELLONA LINEN*/CHROMED STEEL

Moon

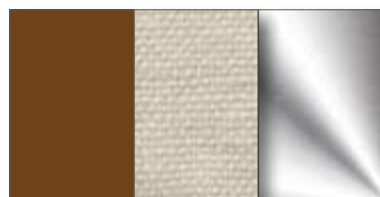

859
 MATTONE/AVORIO/CROMO
 RED BRICK/IVORY/CHROME

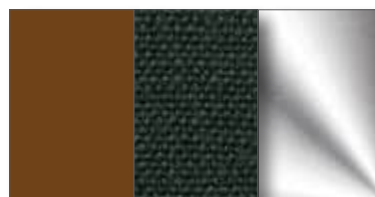

926
 MATTONE/VERDE SCURO/CROMO
 RED BRICK/DARK GREEN/CHROME

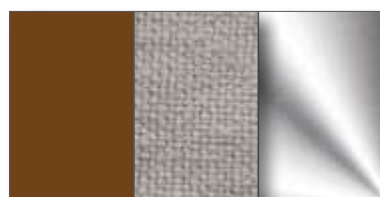

917
 MATTONE/SABBIA/CROMO
 RED BRICK/SAND/CHROME

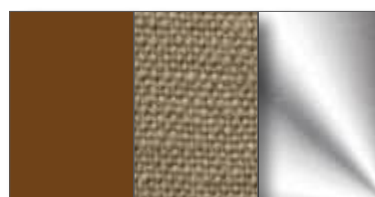

895
 MATTONE/MARRONE CHIARO/CROMO
 RED BRICK/LIGHT BROWN/CHROME

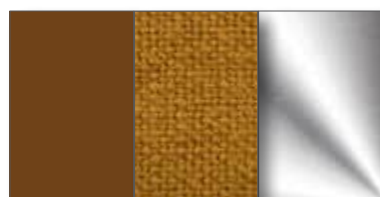

879
 MATTONE/GIALLO SENAPE/CROMO
 RED BRICK/MUSTARD YELLOW/CHROME

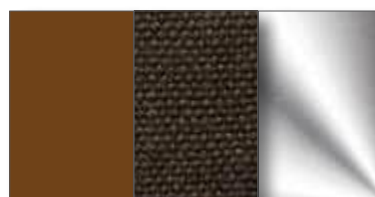

897
 MATTONE/MARRONE SCURO/CROMO
 RED BRICK/DARK BROWN/CHROME

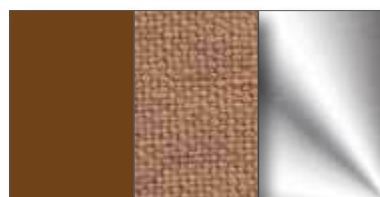

909
 MATTONE/ROSA/CROMO
 RED BRICK/PINK/CHROME

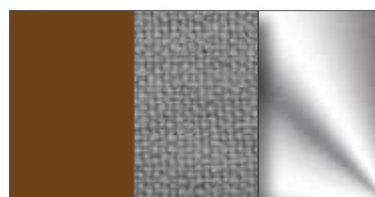

886
 MATTONE/GRIGIO CHIARO/CROMO
 RED BRICK/LIGHT GREY/CHROME

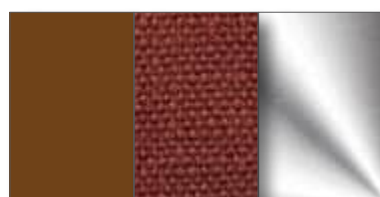

910
 MATTONE/ROSSO ANTICO/CROMO
 RED BRICK/ANTIQUE RED/CHROME

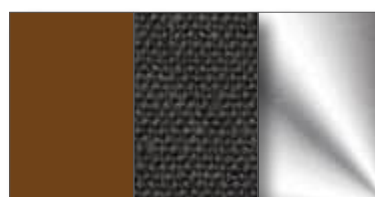

891
 MATTONE/GRIGIO SCURO/CROMO
 RED BRICK/DARK GREY/CHROME

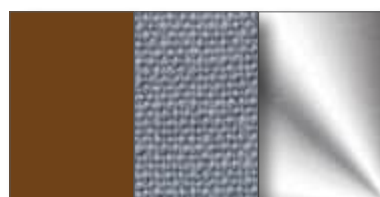

862
 MATTONE/AZZURRO/CROMO
 RED BRICK/LIGHT BLUE/CHROME

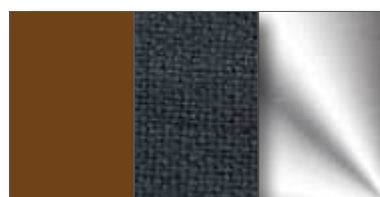

871
 MATTONE/BLU/CROMO
 RED BRICK/BLUE/CHROME

CAT.C

407 PU RIGIDO VERNICIATO/LINO BARCELLONA/ACCIAIO CROMATO
 STIFF PAINTED PU/*BARCELLONA LINEN*/CHROMED STEEL

Moon

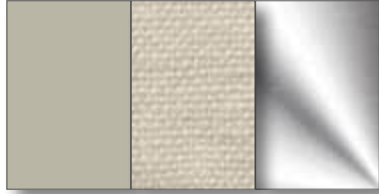

931
 ECRU/AVORIO/CROMO
 ECRU/IVORY/CHROME

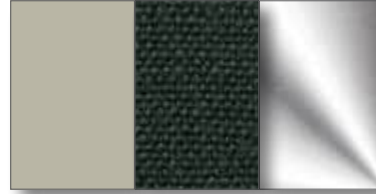

998
 ECRU/VERDE SCURO/CROMO
 ECRU/DARK GREEN/CHROME

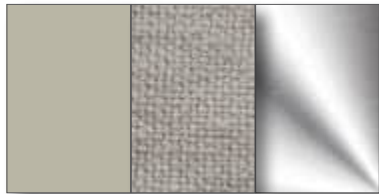

989
 ECRU/SABBIA/CROMO
 ECRU/SAND/CHROME

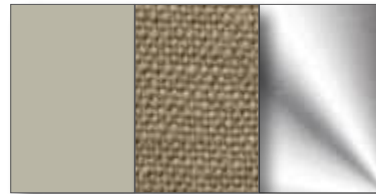

967
 ECRU/MARRONE CHIARO/CROMO
 ECRU/LIGHT BROWN/CHROME

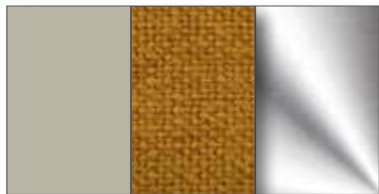

951
 ECRU/GIALLO SENAPE/CROMO
 ECRU/MUSTARD YELLOW/CHROME

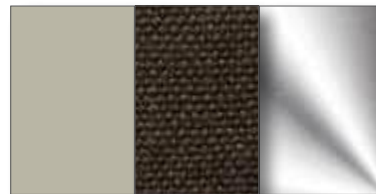

969
 ECRU/MARRONE SCURO/CROMO
 ECRU/DARK BROWN/CHROME

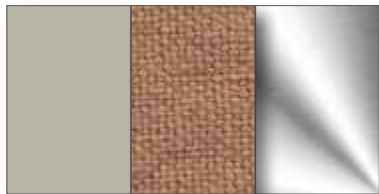

981
 ECRU/ROSA/CROMO
 ECRU/PINK/CHROME

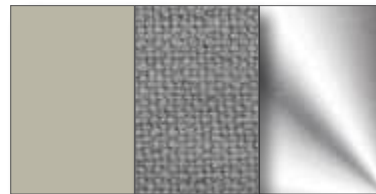

958
 ECRU/GRIGIO CHIARO/CROMO
 ECRU/LIGHT GREY/CHROME

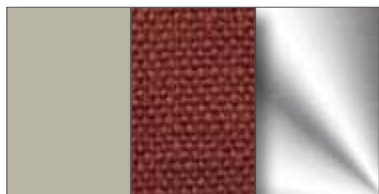

982
 ECRU/ROSSO ANTICO/CROMO
 ECRU/ANTIQUE RED/CHROME

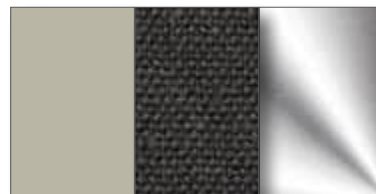

963
 ECRU/GRIGIO SCURO/CROMO
 ECRU/DARK GREY/CHROME

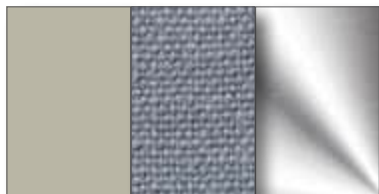

934
 ECRU/AZZURRO/CROMO
 ECRU/LIGHT BLUE/CHROME

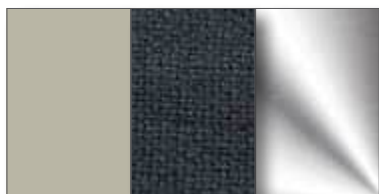

943
 ECRU/BLU/CROMO
 ECRU/BLUE/CHROME

CAT.C

407 PU RIGIDO VERNICIATO/LINO BARCELLONA/ACCIAIO CROMATO
 STIFF PAINTED PU/*BARCELLONA LINEN*/CHROMED STEEL

Moon

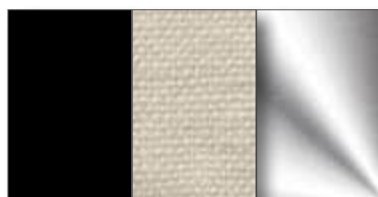

A03
 NERO/AVORIO/CROMO
 BLACK/IVORY/CHROME

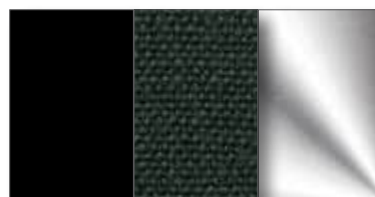

A70
 NERO/VERDE SCURO/CROMO
 BLACK/DARK GREEN/CHROME

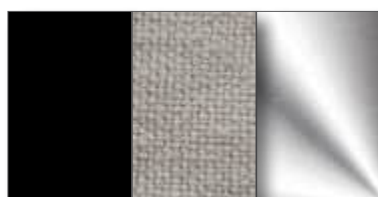

A61
 NERO/SABBIA/CROMO
 BLACK/SAND/CHROME

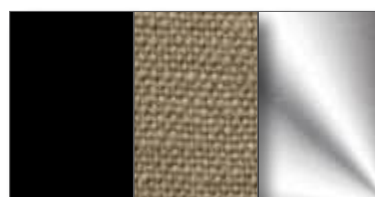

A39
 NERO/MARRONE CHIARO/CROMO
 BLACK/LIGHT BROWN/CHROME

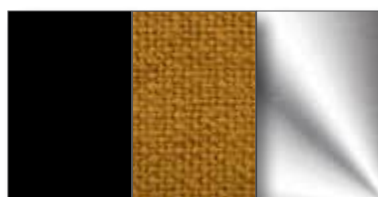

A23
 NERO/GIALLO SENAPE/CROMO
 BLACK/MUSTARD YELLOW/CHROME

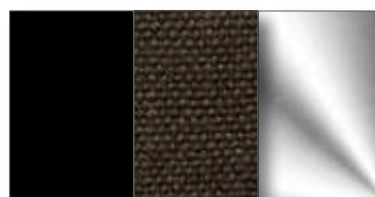

A41
 NERO/MARRONE SCURO/CROMO
 BLACK/DARK BROWN/CHROME

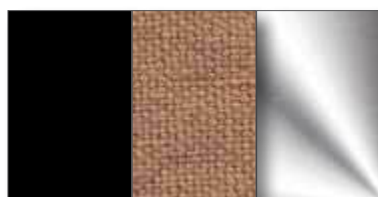

A53
 NERO/ROSA/CROMO
 BLACK/PINK/CHROME

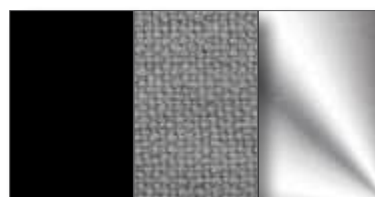

A30
 NERO/GRIGIO CHIARO/CROMO
 BLACK/LIGHT GREY/CHROME

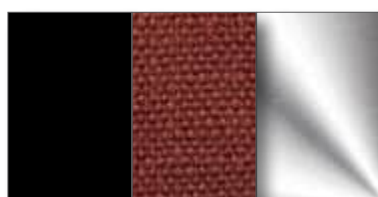

A54
 NERO/ROSSO ANTICO/CROMO
 BLACK/ANTIQUE RED/CHROME

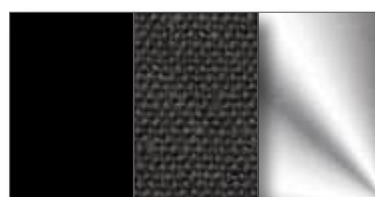

A35
 NERO/GRIGIO SCURO/CROMO
 BLACK/DARK GREY/CHROME

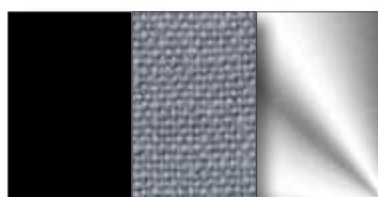

A06
 NERO/AZZURRO/CROMO
 BLACK/LIGHT BLUE/CHROME

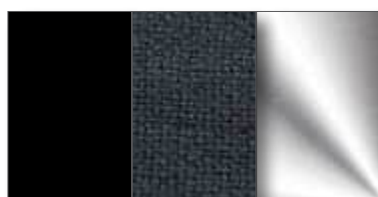

A15
 NERO/BLU/CROMO
 BLACK/BLUE/CHROME

CAT.C

719 POLIESTERE MOSCA - *POLYESTER MOSCA*

Composizione/Composition: 100% PL Altezza/Height: 145 cm. Peso/Weight: 950gr.



008
PANNA
CREAM

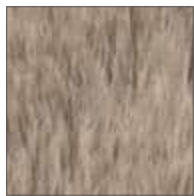

016
TORTORA
TAUPE

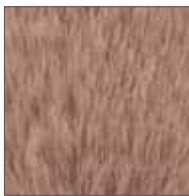

024
ROSA
PINK



072
BLU
BLUE

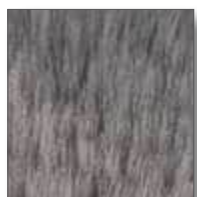

045
GRIGIO CHIARO
LIGHT GREY

I colori sono indicativi. Non è possibile garantire uniformità di tono nella tintura dei lotti di tessuto. Resta inteso che lievi differenze di colore verranno accettate al momento dell'ordine.

The colors are just indicative. Actually a steady tone of lots cannot be guaranteed. It remains understood that any slight colour difference will be accepted in case an order is placed.

CAT.C

858 POLIESTERE MOSCA/ACCIAIO VERNICIATO - *POLYESTER MOSCA/PAINTED STEEL*

Cocky



637
PANNA/NERO
CREAM/BLACK

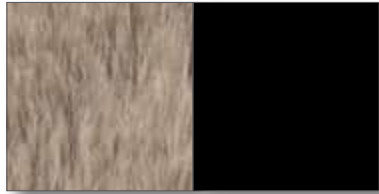

655
TORTORA/NERO
TAUPE/BLACK

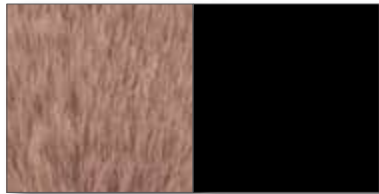

643
ROSA/NERO
PINK/BLACK

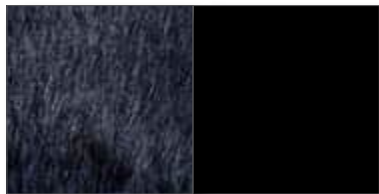

604
BLU/NERO
BLUE/BLACK



620
GRIGIO CHIARO/NERO
LIGHT GREY/BLACK

CAT.C

859 POLIESTERE MOSCA/ALLUMINIO LUCIDATO - POLYESTER MOSCA/POLISHED ALUMINUM

Cocky

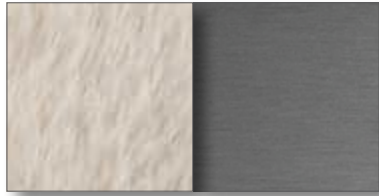

566
PANNA/ALLUMINIO
CREAM/ALUMINUM



582
TORTORA/ALLUMINIO
TAUPE/ALUMINUM

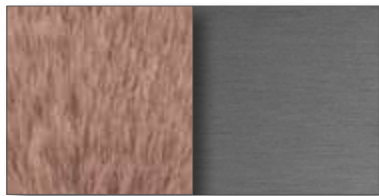

572
ROSA/ALLUMINIO
PINK/ALUMINUM

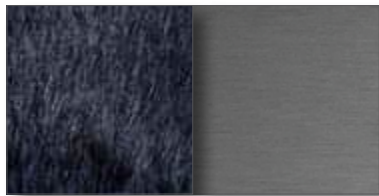

536
BLU/ALLUMINIO
BLUE/ALUMINUM

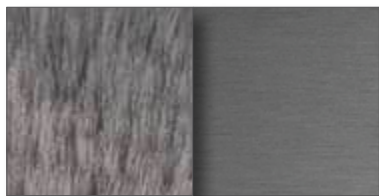

550
GRIGIO CHIARO/ALLUMINIO
LIGHT GREY/ALUMINUM

CAT.C

864 PU RIGIDO VERNICIATO/POLIESTERE MOSCA/ACCIAIO CROMATO
 STIFF PAINTED PU/POLYESTER MOSCA/CHROMED STEEL

Moon

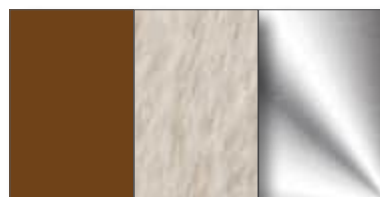

G13
 MATTONE/PANNA/CROMO
 RED BRICK/CREAM/CHROME

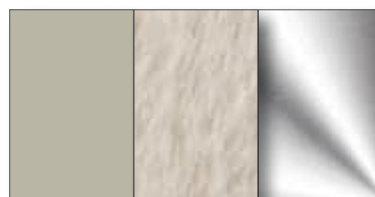

105
 ECRU/PANNA/CROMO
 ECRU/CREAM/CHROME

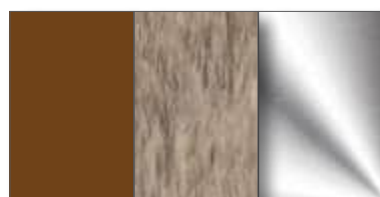

920
 MATTONE/TORTORA/CROMO
 RED BRICK/TAUPE/CHROME

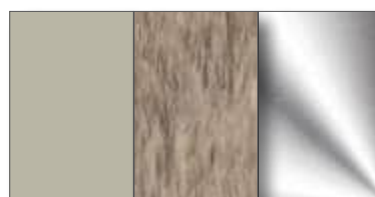

992
 ECRU/TORTORA/CROMO
 ECRU/TAUPE/CHROME

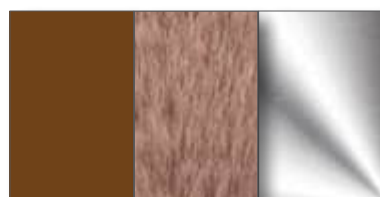

909
 MATTONE/ROSA/CROMO
 RED BRICK/PINK/CHROME

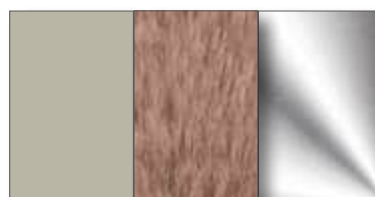

981
 ECRU/ROSA/CROMO
 ECRU/PINK/CHROME

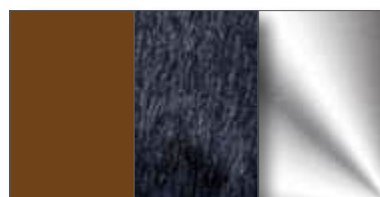

871
 MATTONE/BLU/CROMO
 RED BRICK/BLUE/CHROME

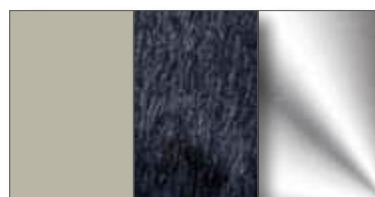

943
 ECRU/BLU/CROMO
 ECRU/BLUE/CHROME

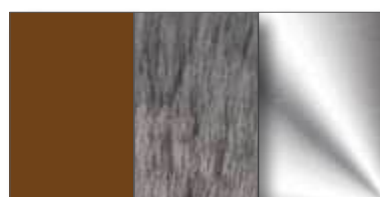

886
 MATTONE/GRIGIO CHIARO/CROMO
 RED BRICK/LIGHT GREY/CHROME

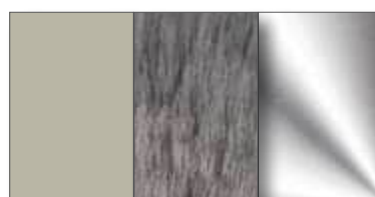

958
 ECRU/GRIGIO CHIARO/CROMO
 ECRU/LIGHT GREY/CHROME

CAT.C

864 PU RIGIDO VERNICIATO/POLIESTERE MOSCA/ACCIAIO CROMATO
 STIFF PAINTED PU/POLYESTER MOSCA/CHROMED STEEL

Moon

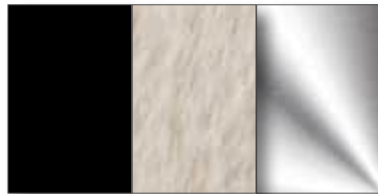

G11
 NERO/PANNA/CROMO
 BLACK/CREAM/CHROME

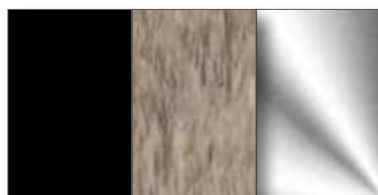

A64
 NERO/TORTORA/CROMO
 BLACK/TAUPE/CHROME

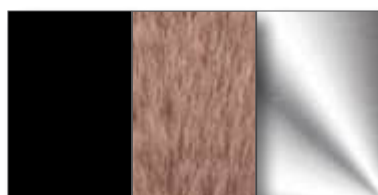

A53
 NERO/ROSA/CROMO
 BLACK/PINK/CHROME

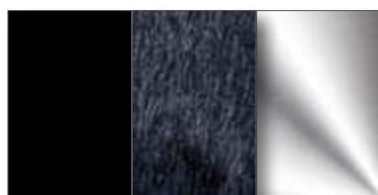

A15
 NERO/BLU/CROMO
 BLACK/BLUE/CHROME

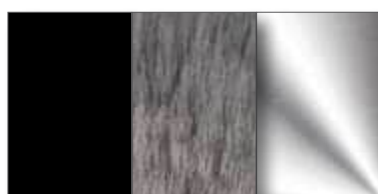

A30
 NERO/GRIGIO CHIARO/CROMO
 BLACK/LIGHT GREY/CHROME

CAT.C

868 POLIESTERE MOSCA/ACCIAIO CROMATO
 POLYESTER MOSCA/CHROMED STEEL

Cocky



I06
 PANNA/CROMO
 CREAM/CHROME



E86
 TORTORA/CROMO
 TAUPE/CHROME

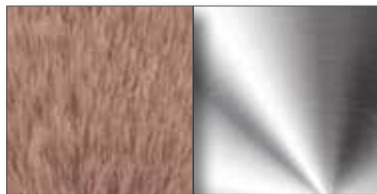

H27
 ROSA/CROMO
 PINK/CHROME



C40
 BLU/CROMO
 BLUE/CHROME



C51
 GRIGIO CHIARO/CROMO
 LIGHT GREY/CHROME

CAT.D

712 MISTO LANA MALMÖ - WOOL MIX MALMÖ

Composizione/Composition: 32% CO, 61% VW, 7% PA. Altezza/Height: 140 cm. Peso/Weight: 1200gr. Abrasione/Abrasion: 25.000 Martindale (uso pubblico, uso regolare/public use, regular use).



002
BIANCO
WHITE



011
SABBIA
SAND



069
PETROLIO
PETROL GREEN

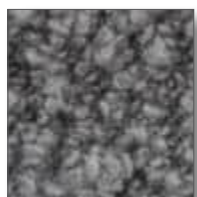
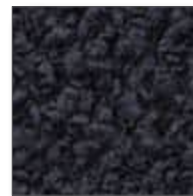

045
GRIGIO CHIARO
LIGHT GREY



050
GRIGIO SCURO
DARK GREY

I colori sono indicativi. Non è possibile garantire uniformità di tono nella tintura dei lotti di tessuto. Resta inteso che lievi differenze di colore verranno accettate al momento dell'ordine.

The colors are just indicative. Actually a steady tone of lots cannot be guaranteed. It remains understood that any slight colour difference will be accepted in case an order is placed.

CAT.D

803 MISTO LANA MALMÖ/ACCIAIO VERNICIATO - WOOL MIX MALMÖ/PAINTED STEEL

Sof Sof, 33 Cuscini

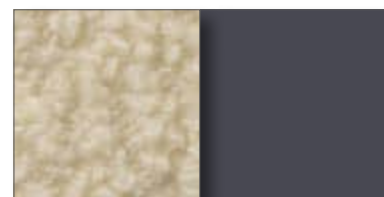

328
BIANCO/GRAFITE
WHITE/GRAPHITE

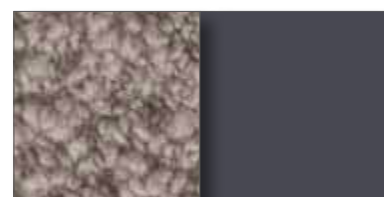

377
SABBIA/GRAFITE
SAND/GRAPHITE

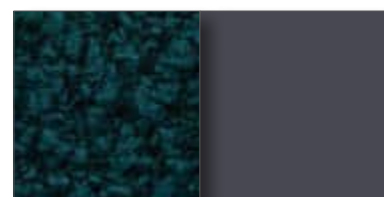

367
PETROLIO/GRAFITE
PETROL GREEN/GRAPHITE

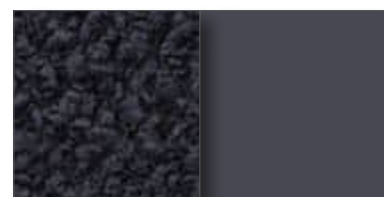

336
BLU/GRAFITE
BLUE/GRAPHITE

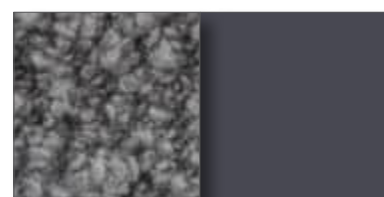

348
GRIGIO CHIARO/GRAFITE
LIGHT GREY/GRAPHITE

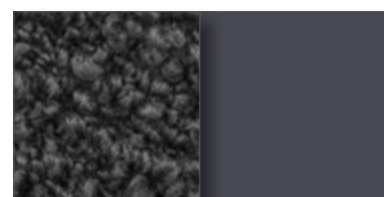

353
GRIGIO SCURO/GRAFITE
DARK GREY/GRAPHITE

Elisa

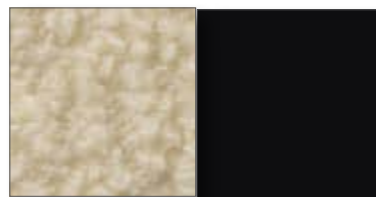

393
BIANCO/NERO MARRONE
WHITE/BLACK BROWN

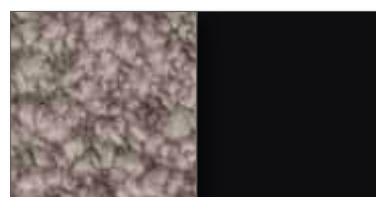

426
SABBIA/NERO MARRONE
SAND/BLACK BROWN

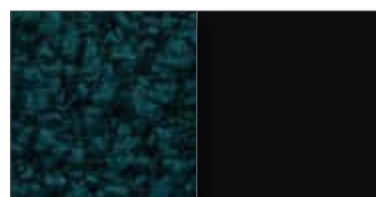

419
PETROLIO/NERO MARRONE
PETROL GREEN/BLACK BROWN

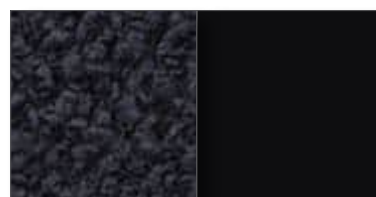

400
BLU/NERO MARRONE
BLUE/BLACK BROWN

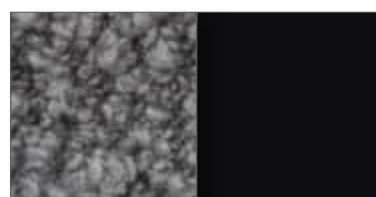

407
GRIGIO CHIARO/NERO MARRONE
LIGHT GREY/BLACK BROWN

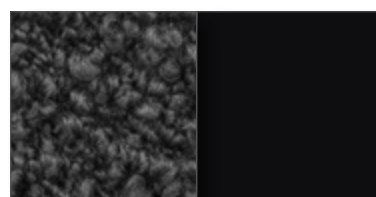

411
GRIGIO SCURO/NERO MARRONE
DARK GREY/BLACK BROWN

CAT.D

803 MISTO LANA MALMÖ/ACCIAIO VERNICIATO - WOOL MIX MALMÖ/PAINTED STEEL

Fenix



442
BIANCO/PELTRO BRONZATO
WHITE/BRONZE PEWTER



498
SABBIA/PELTRO BRONZATO
SAND/BRONZE PEWTER



486
PETROLIO/PELTRO BRONZATO
PETROL GREEN/BRONZE PEWTER

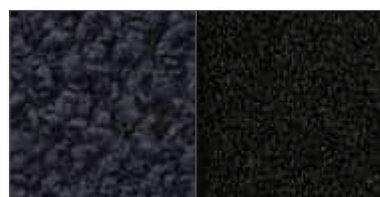

450
BLU/PELTRO BRONZATO
BLUE/BRONZE PEWTER

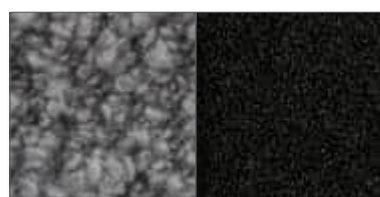

466
GRIGIO CHIARO/PELTRO BRONZATO
LIGHT GREY/BRONZE PEWTER

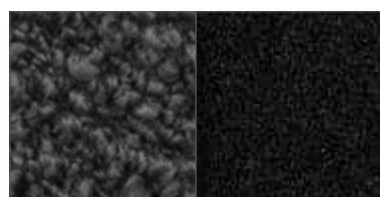

471
GRIGIO SCURO/PELTRO BRONZATO
DARK GREY/BRONZE PEWTER

Cocky



596
BIANCO/NERO
WHITE/BLACK

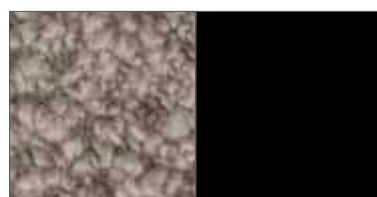

651
SABBIA/NERO
SAND/BLACK



639
PETROLIO/NERO
PETROL GREEN/BLACK

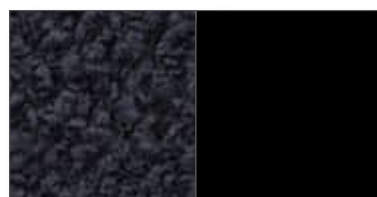

604
BLU/NERO
BLUE/BLACK



620
GRIGIO CHIARO/NERO
LIGHT GREY/BLACK

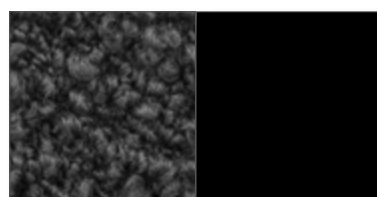

625
GRIGIO SCURO/NERO
DARK GREY/BLACK

CAT.D

805 MISTO LANA MALMÖ/ALLUMINIO VERNICIATO - *WOOL MIX MALMÖ/PAINTED ALUMINUM*

Lirica, Lirico

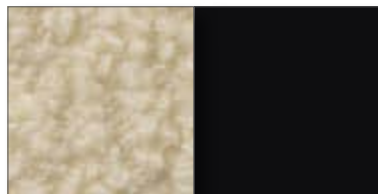

596
BIANCO/NERO
WHITE/BLACK



722
BIANCO/ARGENTO
WHITE/SILVER

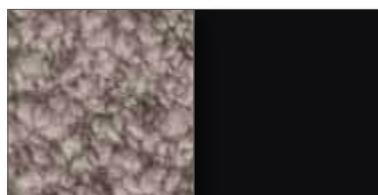

651
SABBIA/NERO
SAND/BLACK



778
SABBIA/ARGENTO
SAND/SILVER



639
PETROLIO/NERO
PETROL GREEN/BLACK



766
PETROLIO/ARGENTO
PETROL GREEN/SILVER

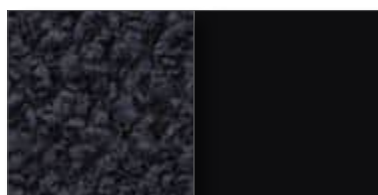

604
BLU/NERO
BLUE/BLACK

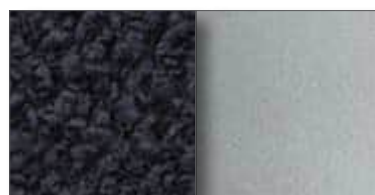

730
BLU/ARGENTO
BLUE/SILVER

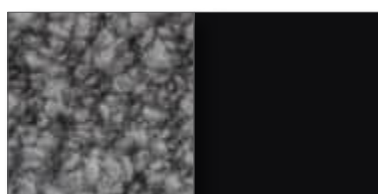

620
GRIGIO CHIARO/NERO
LIGHT GREY/BLACK



746
GRIGIO CHIARO/ARGENTO
LIGHT GREY/SILVER

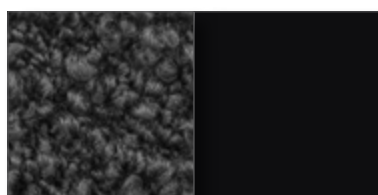

625
GRIGIO SCURO/NERO
DARK GREY/BLACK



751
GRIGIO SCURO/ARGENTO
DARK GREY/SILVER

CAT.D

808 MISTO LANA MALMÖ/FAGGIO LACCATO - WOOL MIX MALMÖ/LACQUERED BEECH

S.Marco, S,Marco Lounge



596
BIANCO/NERO
WHITE/BLACK

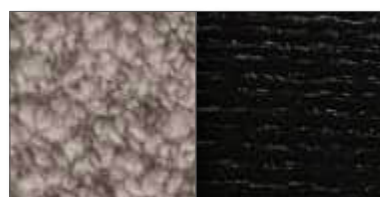

651
SABBIA/NERO
SAND/BLACK



639
PETROLIO/NERO
PETROL GREEN/BLACK

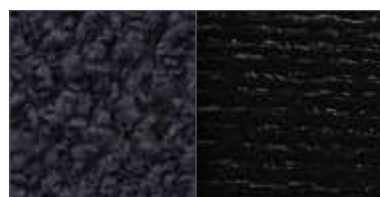

604
BLU/NERO
BLUE/BLACK

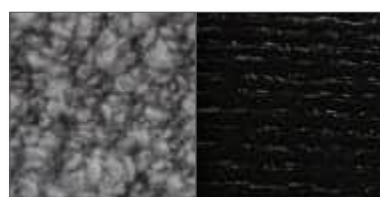

620
GRIGIO CHIARO/NERO
LIGHT GREY/BLACK

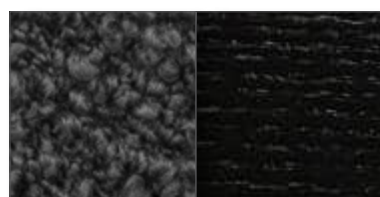

625
GRIGIO SCURO/NERO
DARK GREY/BLACK

Cocky

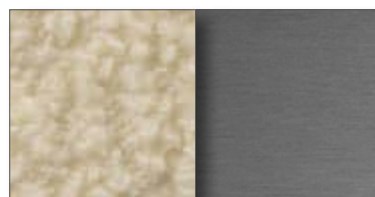

531
BIANCO/ALLUMINIO
WHITE/ALUMINUM

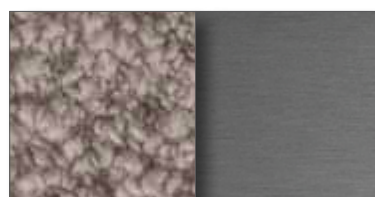

578
SABBIA/ALLUMINIO
SAND/ALUMINUM

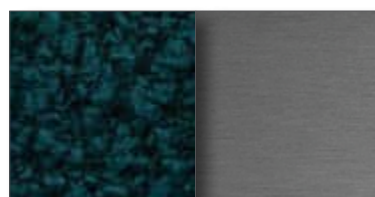

568
PETROLIO/ALLUMINIO
PETROL GREEN/ALUMINUM

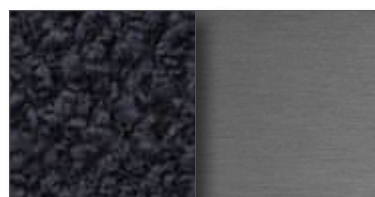

536
BLU/ALLUMINIO
BLUE/ALUMINUM

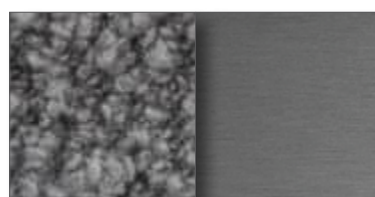

550
GRIGIO CHIARO/ALLUMINIO
LIGHT GREY/ALUMINUM

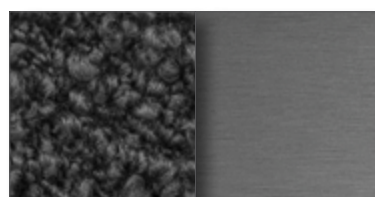

554
GRIGIO SCURO/ALLUMINIO
DARK GREY/ALUMINUM

CAT.D

809 PU RIGIDO VERNICIATO/MISTO LANA MALMÖ/ACCIAIO CROMATO
 STIFF PAINTED PU/WOOL MIX MALMÖ/CHROMED STEEL

Moon

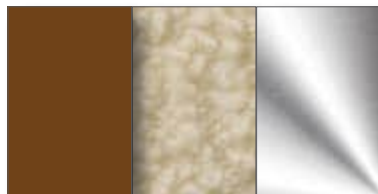

864
 MATTONE/BIANCO/CROMO
 RED BRICK/WHITE/CHROME



936
 ECRU'/BIANCO/CROMO
 ECRU'/WHITE/CHROME

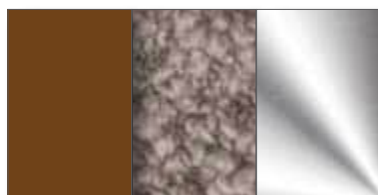

917
 MATTONE/SABBIA/CROMO
 RED BRICK/SAND/CHROME

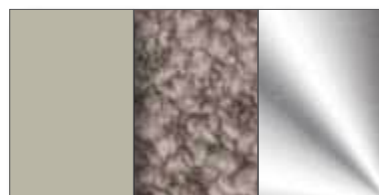

989
 ECRU'/SABBIA/CROMO
 ECRU'/SAND/CHROME

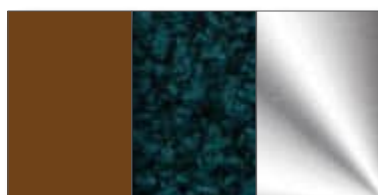

905
 MATTONE/PETROLIO/CROMO
 RED BRICK/PETROL GREEN/CHROME

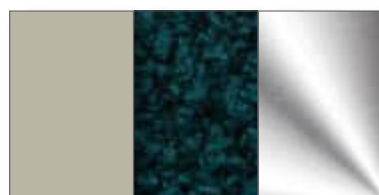

977
 ECRU'/PETROLIO/CROMO
 ECRU'/PETROL GREEN/CHROME

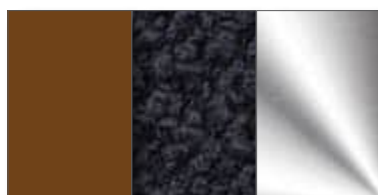

871
 MATTONE/BLU/CROMO
 RED BRICK/BLUE/CHROME

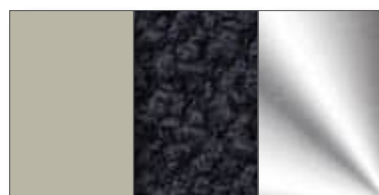

943
 ECRU'/BLU/CROMO
 ECRU'/BLUE/CHROME

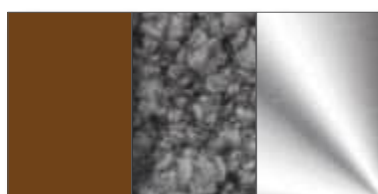

886
 MATTONE/GRIGIO CHIARO/CROMO
 RED BRICK/LIGHT GREY/CHROME

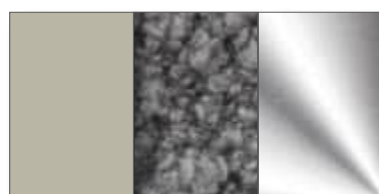

958
 ECRU'/GRIGIO CHIARO/CROMO
 ECRU'/LIGHT GREY/CHROME

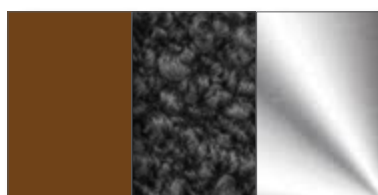

891
 MATTONE/GRIGIO SCURO/CROMO
 RED BRICK/DARK GREY/CHROME

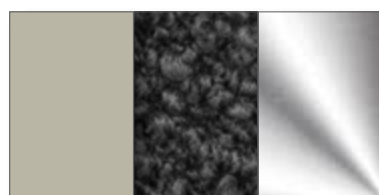

963
 ECRU'/GRIGIO SCURO/CROMO
 ECRU'/DARK GREY/CHROME

CAT.D

809 PU RIGIDO VERNICIATO/MISTO LANA MALMÖ/ACCIAIO CROMATO
 STIFF PAINTED PU/WOOL MIX MALMÖ/CHROMED STEEL

Moon

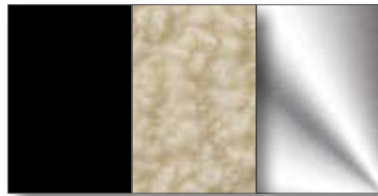

A08
 NERO/BIANCO/CROMO
 BLACK/WHITE/CHROME



954
 NERO/SABBIA/CROMO
 BLACK/SAND/CHROME

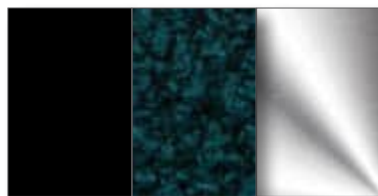

A49
 NERO/PETROLIO/CROMO
 BLACK/PETROL GREEN/CHROME

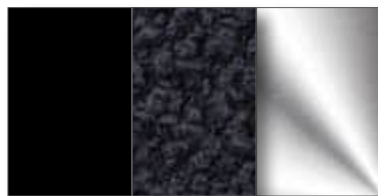

A15
 NERO/BLU/CROMO
 BLACK/BLUE/CHROME

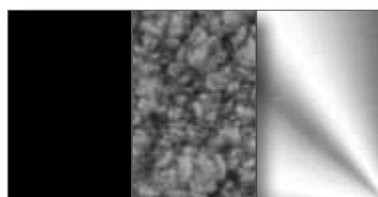

A30
 NERO/GRIGIO CHIARO/CROMO
 BLACK/LIGHT GREY/CHROME

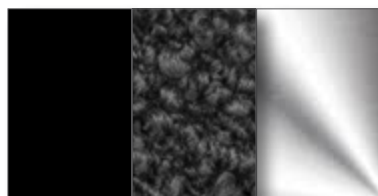

A35
 NERO/GRIGIO SCURO/CROMO
 BLACK/DARK GREY/CHROME

CAT.D

877 MISTO LANA MALMÖ/ACCIAIO CROMATO
 WOOL MIX MALMÖ/CHROMED STEEL

Cocky



B00
 BIANCO/CROMO
 WHITE/CHROME

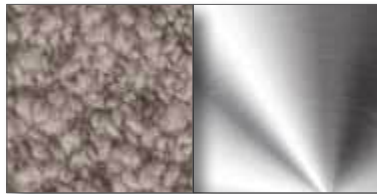

C59
 SABBIA/CROMO
 SAND/CHROME

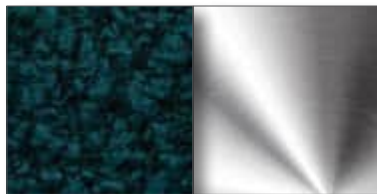

C56
 PETROLIO/CROMO
 PETROL GREEN/CHROME

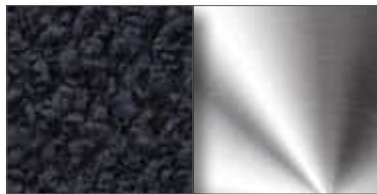

C40
 BLU/CROMO
 BLUE/CHROME

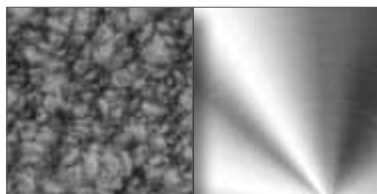

C51
 GRIGIO CHIARO/CROMO
 LIGHT GREY/CHROME

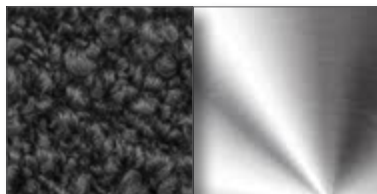

C47
 GRIGIO SCURO/CROMO
 DARK GREY/CHROME

CATE

713 LANA DIVINA (KVADRAT) - WOOL DIVINA (KVADRAT)

Composizione/Composition: 100% VW. Altezza/Height: 150 cm. Peso/Weight: 840gr. Abrasione/Abrasion: 45.000 Martindale (uso pubblico, uso molto intensivo/public use, very intensive use), CAL117, crib51MOFTP,UNI9175 11M



011
SABBIA
SAND



021
GIALLO
YELLOW



024
ROSA
PINK



039
ROSSO
RED



060
AZZURRO
LIGHT BLUE

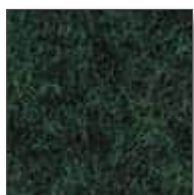

066
VERDE SCURO
DARK GREEN



081
MARRONE
BROWN



073
BLU SCURO
DARK BLUE



045
GRIGIO CHIARO
LIGHT GREY



091
NERO
BLACK

I colori sono indicativi. Non è possibile garantire uniformità di tono nella tintura dei lotti di tessuto. Resta inteso che lievi differenze di colore verranno accettate al momento dell'ordine.

The colors are just indicative. Actually a steady tone of lots cannot be guaranteed. It remains understood that any slight colour difference will be accepted in case an order is placed.

CATE

810 LANA DIVINA (KVADRAT)/FRASSINO - WOOL DIVINA (KVADRAT)/ASH

La Francesa



221
SABBIA/NATURALE
SAND/NATURAL

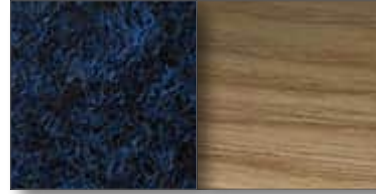

180
BLU SCURO/NATURALE
DARK BLUE/NATURAL



190
GIALLO/NATURALE
YELLOW/NATURAL



197
GRIGIO CHIARO/NATURALE
LIGHT GREY/NATURAL



216
ROSA/NATURALE
PINK/NATURAL



207
NERO/NATURALE
BLACK/NATURAL



219
ROSSO/NATURALE
RED/NATURAL



175
AZZURRO/NATURALE
LIGHT BLUE/NATURAL



227
VERDE SCURO/NATURALE
DARK GREEN/NATURAL



206
MARRONE/NATURALE
BROWN/NATURAL

CATE

810 LANA DIVINA (KVADRAT)/FRASSINO - WOOL DIVINA (KVADRAT)/ASH

La Francesea



282
SABBIA/EBANIZZATO
SAND/EBONIZED



240
BLU SCURO/EBANIZZATO
DARK BLUE/EBONIZED



250
GIALLO/EBANIZZATO
YELLOW/EBONIZED



256
GRIGIO CHIARO/EBANIZZATO
LIGHT GREY/EBONIZED

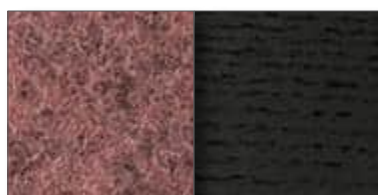

277
ROSA/EBANIZZATO
PINK/EBONIZED



267
NERO/EBANIZZATO
BLACK/EBONIZED

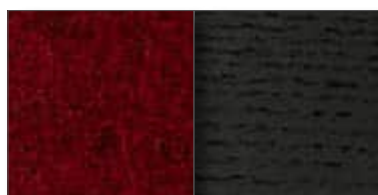

280
ROSSO/EBANIZZATO
RED/EBONIZED



236
AZZURRO/EBANIZZATO
LIGHT BLUE/EBONIZED

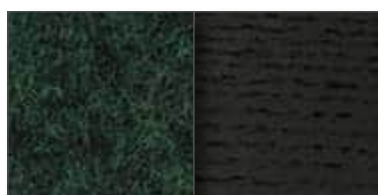

289
VERDE SCURO/EBANIZZATO
DARK GREEN/EBONIZED



266
MARRONE/EBANIZZATO
BROWN/EBONIZED

CATE

812 LANA DIVINA (KVADRAT)/ACCIAIO VERNICIATO - *WOOL DIVINA (KVADRAT)/PAINTED STEEL*

Sof Sof, 33 Cuscini



377
SABBIA/GRAFITE
SAND/GRAPHITE



334
BLU SCURO/GRAFITE
DARK BLUE/GRAPHITE

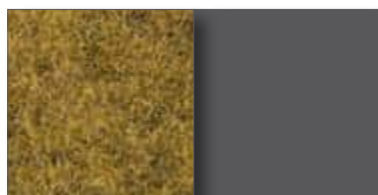

342
GIALLO/GRAFITE
YELLOW/GRAPHITE



348
GRIGIO CHIARO/GRAFITE
LIGHT GREY/GRAPHITE

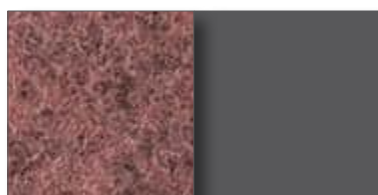

370
ROSA/GRAFITE
PINK/GRAPHITE



361
NERO/GRAFITE
BLACK/GRAPHITE

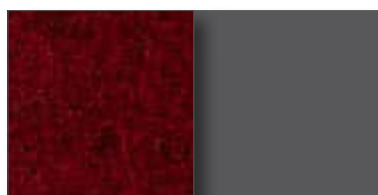

374
ROSSO/GRAFITE
RED/GRAPHITE

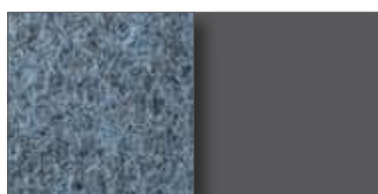

326
AZZURRO/GRAFITE
LIGHT BLUE/GRAPHITE



384
VERDE SCURO/GRAFITE
DARK GREEN/GRAPHITE

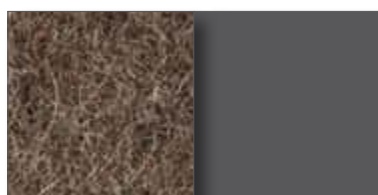

360
MARRONE/GRAFITE
BROWN/GRAPHITE

CATE

812 LANA DIVINA (KVADRAT)/ACCIAIO VERNICIATO - *WOOL DIVINA (KVADRAT)/PAINTED STEEL*

Elisa

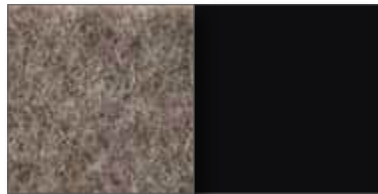

426
SABBIA/NERO MARRONE
SAND/BLACK BROWN



398
BLU SCURO/NERO MARRONE
DARK BLUE/BLACK BROWN

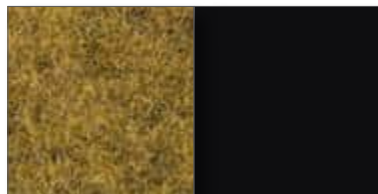

E29
GIALLO/NERO MARRONE
YELLOW/BLACK BROWN

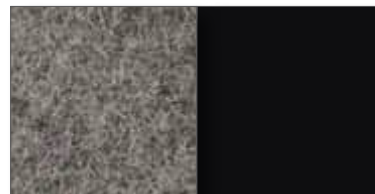

407
GRIGIO CHIARO/NERO MARRONE
LIGHT GREY/BLACK BROWN

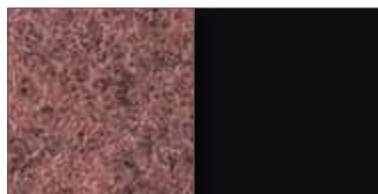

422
ROSA/NERO MARRONE
PINK/BLACK BROWN

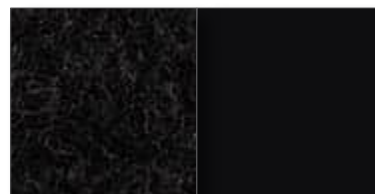

417
NERO/NERO MARRONE
BLACK/BLACK BROWN

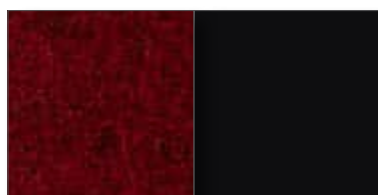

424
ROSSO/NERO MARRONE
RED/BLACK BROWN

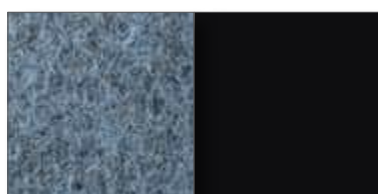

391
AZZURRO/NERO MARRONE
LIGHT BLUE/BLACK BROWN

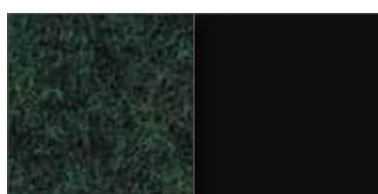

432
VERDE SCURO/NERO MARRONE
DARK GREEN/BLACK BROWN

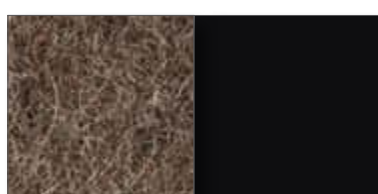

416
MARRONE/NERO MARRONE
BROWN/BLACK BROWN

CATE

812 LANA DIVINA (KVADRAT)/ACCIAIO VERNICIATO - *WOOL DIVINA (KVADRAT)/PAINTED STEEL*

Cocky

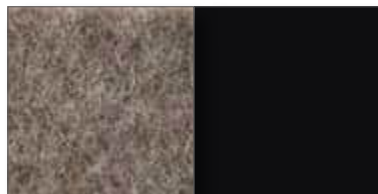

651
SABBIA/NERO
SAND/BLACK

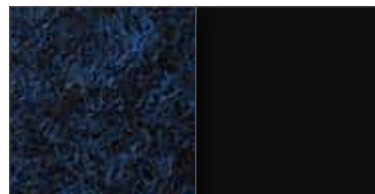

602
BLU SCURO/NERO
DARK BLUE/BLACK

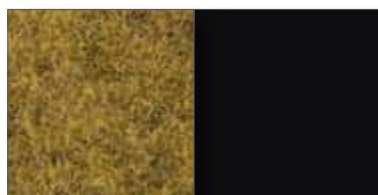

614
GIALLO/NERO
YELLOW/BLACK

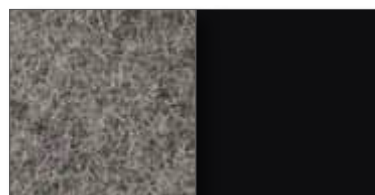

620
GRIGIO CHIARO/NERO
LIGHT GREY/BLACK

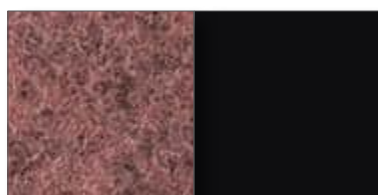

643
ROSA/NERO
PINK/BLACK



632
NERO/NERO
BLACK/BLACK

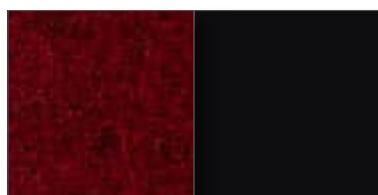

647
ROSSO/NERO
RED/BLACK

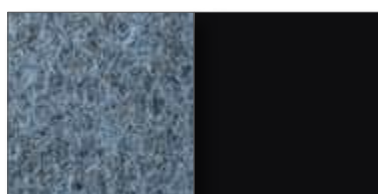

594
AZZURRO/NERO
LIGHT BLUE/BLACK

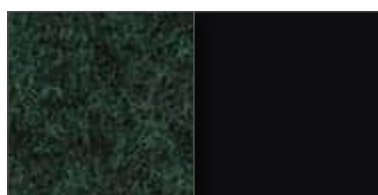

661
VERDE SCURO/NERO
DARK GREEN/BLACK

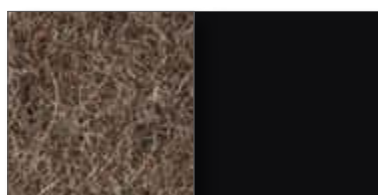







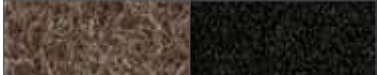
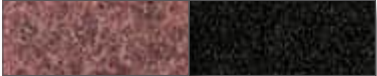

631
MARRONE/NERO
BROWN/BLACK

CATE

812 LANA DIVINA (KVADRAT)/ACCIAIO VERNICIATO - *WOOL DIVINA (KVADRAT)/PAINTED STEEL*

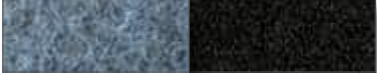
Fenix

	498 SABBIA/PELTRO BR.-SAND/BRONZE PEWTER		507 VERDE SC./PELTRO BR.-DARK GREEN/BR. PEWTER
	C95 GIALLO/PELTRO BR.-YELLOW/BRONZE PEWTER		478 MARRONE/PELTRO BR.-BROWN/BRONZE
	490 ROSA/PELTRO BR.-PINK/BRONZE PEWTER		448 BLUSC./PELTRO BR.-DARK BLUE/BRONZE PEWTER
	494 ROSSO/PELTRO BR.-RED/BRONZE PEWTER		466 GR. CH./PELTRO BR.-LIGHT GREY/BR. PEWTER
	440 AZZURRO/PELTRO BR.-LIGHT BLUE/BR. PEWTER		479 NERO/PELTRO BR.-BLACK/BRONZE PEWTER

CATE

814 LANA DIVINA (KVADRAT)/ALLUMINIO VERNICIATO - *WOOL DIVINA (KVADRAT)/PAINTED ALUMINUM*

Lirica, Lirico

	651 SABBIA/NERO-SAND/BLACK		778 SABBIA/ARGENTO-SAND/SILVER
	614 GIALLO/NERO-YELLOW/BLACK		740 GIALLO/ARGENTO-YELLOW/SILVER
	643 ROSA/NERO-PINK/BLACK		477090 ROSA/ARGENTO-PINK/SILVER
	647 ROSSO/NERO-RED/BLACK		774 ROSSO/ARGENTO-RED/SILVER
	594 AZZURRO/NERO-LIGHT BLUE/BLACK		720 AZZURRO/ARGENTO-LIGHT BLUE/SILVER
	661 VERDE SC./NERO-DARK GREEN/BLACK		788 VERDE SC./ARGENTO-DARK GREEN/SILVER
	631 MARRONE/NERO-BROWN/BLACKK		758 MARRONE/ARGENTO-BROWN/SILVER
	602 BLU SCURO/NERO-DARK BLUE/BLACK		728 BLU SCURO/ARGENTO-DARK BLUE/SILVER
	620 GR. CHIARO/NERO-LIGHT GREY/BLACK		746 GR. CHIARO/ARGENTO-LIGHT GREY/SILVER
	632 NERO/NERO-BLACK/BLACK		759 NERO/ARGENTO-BLACK/SILVER

CATE

817 LANA DIVINA (KVADRAT)/FAGGIO LACCATO - WOOL DIVINA (KVADRAT)/LACQUERED BEECH

S.Marco, S.Marco Lounge



651
SABBIA/NERO
SAND/BLACK

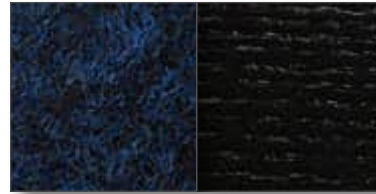

602
BLU SCURO/NERO
DARK BLUE/BLACK



614
GIALLO/NERO
YELLOW/BLACK



620
GRIGIO CHIARO/NERO
LIGHT GREY/BLACK

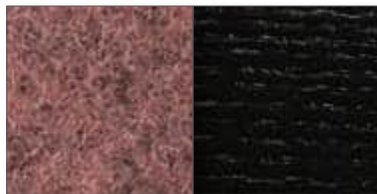

643
ROSA/NERO
PINK/BLACK



632
NERO/NERO
BLACK/BLACK



647
ROSSO/NERO
RED/BLACK



594
AZZURRO/NERO
LIGHT BLUE/BLACK



661
VERDE SCURO/NERO
DARK GREEN/BLACK



631
MARRONE/NERO
BROWN/BLACK

CATE

818 PU RIGIDO VERNICIATO/LANA DIVINA (KVADRAT)/ACCIAIO CROMATO
STIFF PAINTED PU/WOOL DIVINA (KVADRAT)/CHROMED STEEL

Moon

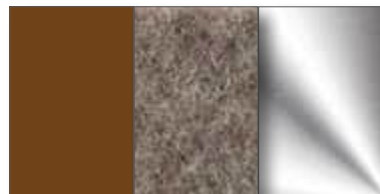

917
MATTONE/SABBIA/CROMO
RED BRICK/SAND/CHROME

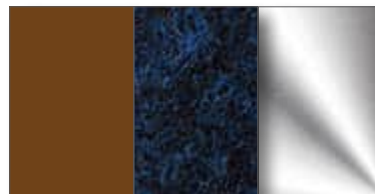

869
MATTONE/BLU SCURO/CROMO
RED BRICK/DARK BLUE/CHROME

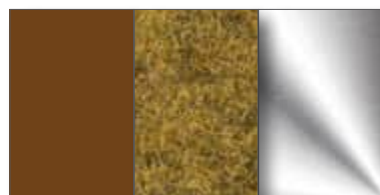

880
MATTONE/GIALLO/CROMO
RED BRICK/YELLOW/CHROME

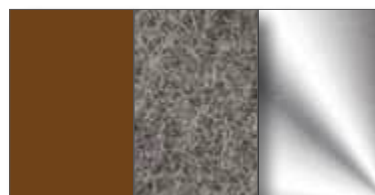

886
MATTONE/GRIGIO CHIARO/CROMO
RED BRICK/LIGHT GREY/CHROME

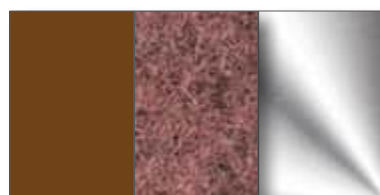

909
MATTONE/ROSA/CROMO
RED BRICK/PINK/CHROME

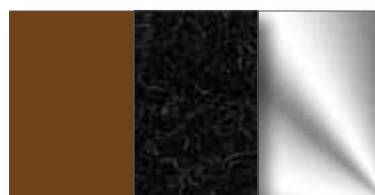

899
MATTONE/NERO/CROMO
RED BRICK/BLACK/CHROME

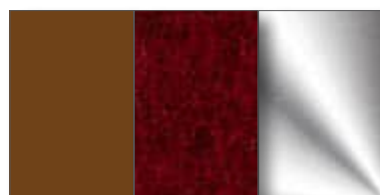

913
MATTONE/ROSSO/CROMO
RED BRICK/RED/CHROME

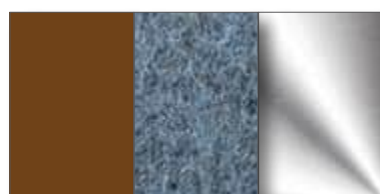

862
MATTONE/AZZURRO/CROMO
RED BRICK/LIGHT BLUE/CHROME

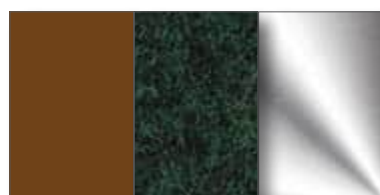

926
MATTONE/VERDE SCURO/CROMO
RED BRICK/DARK GREEN/CHROME

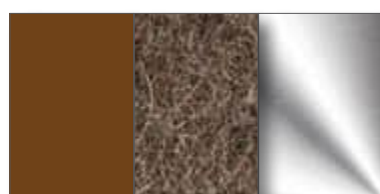

898
MATTONE/MARRONE/CROMO
RED BRICK/BROWN/CHROME

CATE

818 PU RIGIDO VERNICIATO/LANA DIVINA (KVADRAT)/ACCIAIO CROMATO
 STIFF PAINTED PU/WOOL DIVINA (KVADRAT)/CHROMED STEEL

Moon

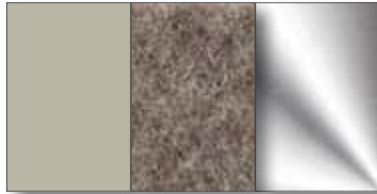

989
 ECRU/SABBIA/CROMO
 ECRU/SAND/CHROME

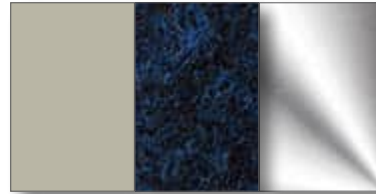

941
 ECRU/BLU SCURO/CROMO
 ECRU/DARK BLUE/CHROME

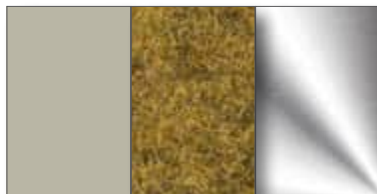

952
 ECRU/GIALLO/CROMO
 ECRU/YELLOW/CHROME

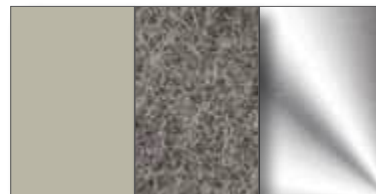

958
 ECRU/GRIGIO CHIARO/CROMO
 ECRU/LIGHT GREY/CHROME

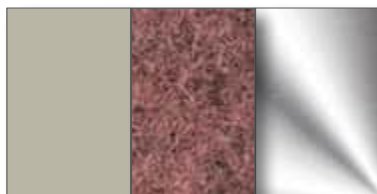

981
 ECRU/ROSA/CROMO
 ECRU/PINK/CHROME

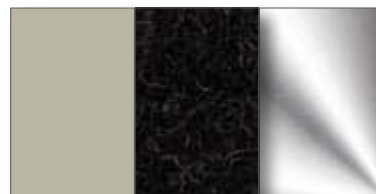

971
 ECRU/NERO/CROMO
 ECRU/BLACK/CHROME

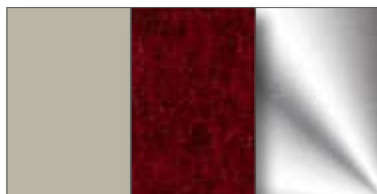

985
 ECRU/ROSSO/CROMO
 ECRU/RED/CHROME

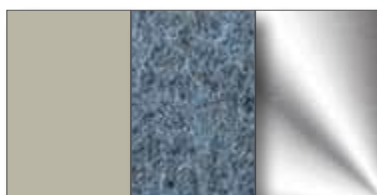

934
 ECRU/AZZURRO/CROMO
 ECRU/LIGHT BLUE/CHROME

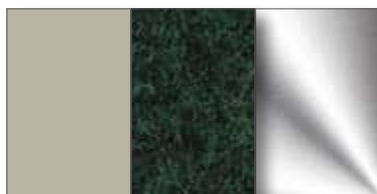

998
 ECRU/VERDE SCURO/CROMO
 ECRU/DARK GREEN/CHROME

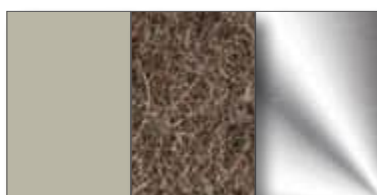

970
 ECRU/MARRONE/CROMO
 ECRU/BROWN/CHROME

CATE

818 PU RIGIDO VERNICIATO/LANA DIVINA (KVADRAT)/ACCIAIO CROMATO
 STIFF PAINTED PU/WOOL DIVINA (KVADRAT)/CHROMED STEEL

Moon

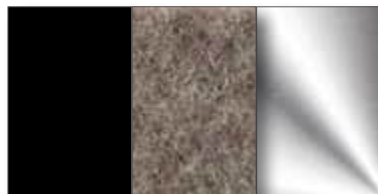

954
 NERO/SABBIA/CROMO
 BLACK/SAND/CHROME

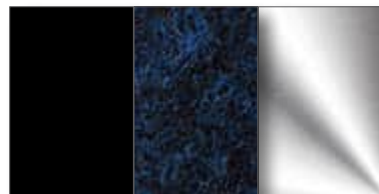

A13
 NERO/BLU SCURO/CROMO
 BLACK/DARK BLUE/CHROME

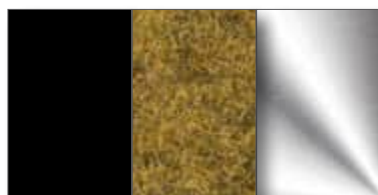

A24
 NERO/GIALLO/CROMO
 BLACK/YELLOW/CHROME

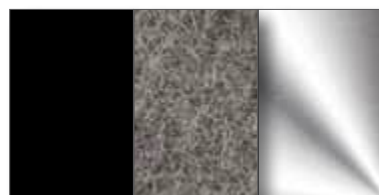

A30
 NERO/GRIGIO CHIARO/CROMO
 BLACK/LIGHT GREY/CHROME

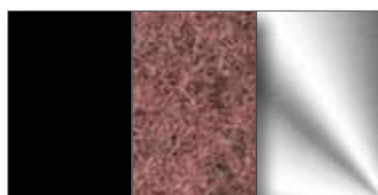

A53
 NERO/ROSA/CROMO
 BLACK/PINK/CHROME

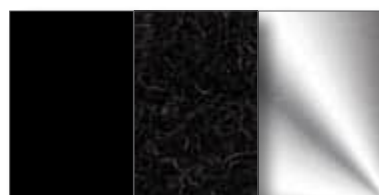

A43
 NERO/NERO/CROMO
 BLACK/BLACK/CHROME



A57
 NERO/ROSSO/CROMO
 BLACK/RED/CHROME



A06
 NERO/AZZURRO/CROMO
 BLACK/LIGHT BLUE/CHROME

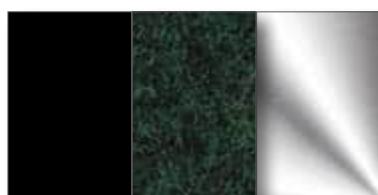

A70
 NERO/VERDE SCURO/CROMO
 BLACK/DARK GREEN/CHROME

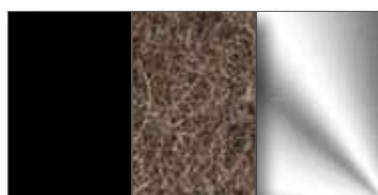

A42
 NERO/MARRONE/CROMO
 BLACK/BROWN/CHROME

CATE

878 LANA DIVINA (KVADRAT)/ACCIAIO CROMATO - WOOL DIVINA (KVADRAT)/CROMED STEEL

Cocky



C59
SABBIA/CROMO
SAND/CHROME

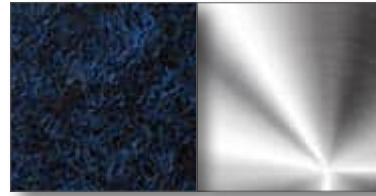

F61
BLU SCURO/CROMO
DARK BLUE/CHROME

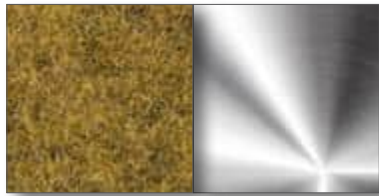

C46
GIALLO/CROMO
YELLOW/CHROME

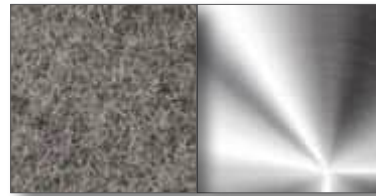

C51
GRIGIO CHIARO/CROMO
LIGHT GREY/CHROME

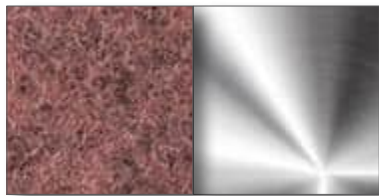

H27
ROSA/CROMO
PINK/CHROME

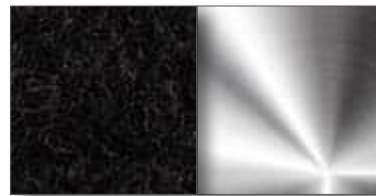

B01
NERO/CROMO
BLACK/CHROME

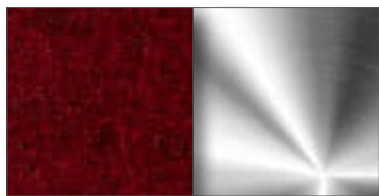

C58
ROSSO/CROMO
RED/CHROME



C37
AZZURRO/CROMO
LIGHT BLUE/CHROME



C63
VERDE SCURO/CROMO
DARK BLUE/CHROME

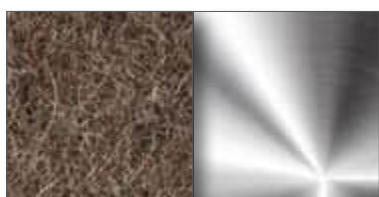

C54
MARRONE/CROMO
BROWN/CHROME

CATE

714 COTONE VENEZIA - COTTON VENEZIA

Composizione/Composition: 100% CO. Altezza/Height: 140 cm. Peso/Weight: 1200gr. Abrasione/Abrasion: 50.000 Martindale, CAL TB117 (uso pubblico, uso molto intensivo/public use, very intensive use).



002
BIANCO
WHITE



040
BORDEAUX
BURGUNDY

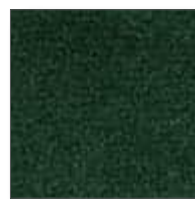

062
VERDE CHIARO
LIGHT GREEN



066
VERDE SCURO
DARK GREEN



073
BLU SCURO
DARK BLUE



050
GRIGIO SCURO
DARK GREY

I colori sono indicativi. Non è possibile garantire uniformità di tono nella tintura dei lotti di tessuto. Resta inteso che lievi differenze di colore verranno accettate al momento dell'ordine.

The colors are just indicative. Actually a steady tone of lots cannot be guaranteed. It remains understood that any slight colour difference will be accepted in case an order is placed.

CATE

821 COTONE VENEZIA/ACCIAIO VERNICIATO - COTTON VENEZIA/PAINTED STEEL

Sof Sof, 33 Cuscini



328
BIANCO/GRAFITE
WHITE/GRAPHITE

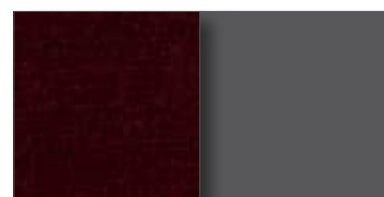

337
BORDEAUX/GRAFITE
BURGUNDY/GRAPHITE

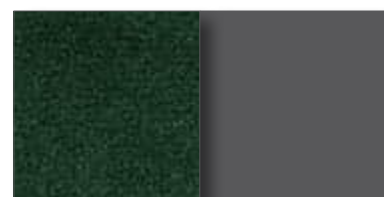

380
VERDE CHIARO/GRAFITE
LIGHT GREEN/GRAPHITE



384
VERDE SCURO/GRAFITE
DARK GREEN/GRAPHITE



334
BLU SCURO/GRAFITE
DARK BLUE/GRAPHITE

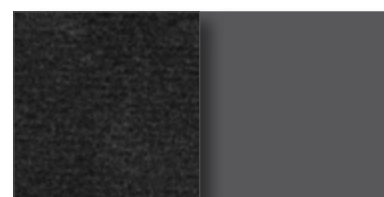

353
GRIGIO SCURO/GRAFITE
DARK GREY/GRAPHITE

Elisa



393
BIANCO/NERO MARRONE
WHITE/BLACK BROWN

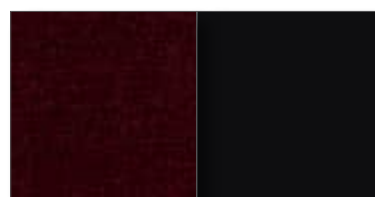

401
BORDEAUX/NERO MARRONE
BURGUNDY/BLACK BROWN

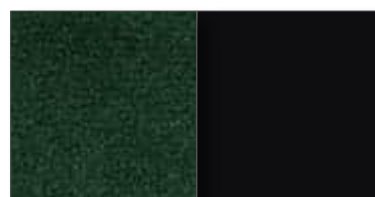

429
VERDE CHIARO/NERO MARRONE
LIGHT GREEN/BLACK BROWN



432
VERDE SCURO/NERO MARRONE
DARK GREEN/BLACK BROWN



398
BLU SCURO/NERO MARRONE
DARK BLUE/BLACK BROWN

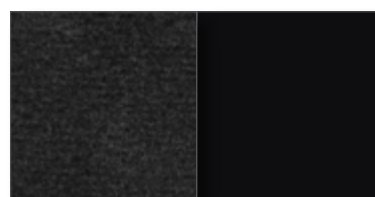

411
GRIGIO SCURO/NERO MARRONE
DARK GREY/BLACK BROWN

CATE

821 COTONE VENEZIA/ACCIAIO VERNICIATO - COTTON VENEZIA/PAINTED STEEL

Cocky



596
BIANCO/NERO
WHITE/BLACK

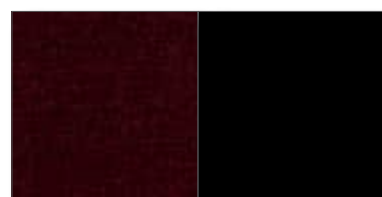

605
BORDEAUX/NERO
BURGUNDY/BLACK



657
VERDE CHIARO/NERO
LIGHT GREEN/BLACK



661
VERDE SCURO/NERO
DARK GREEN/BLACK



602
BLU SCURO/NERO
DARK BLUE/BLACK

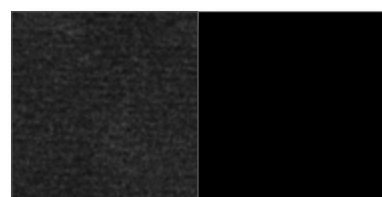

625
GRIGIO SCURO/NERO
DARK GREY/BLACK

Fenix

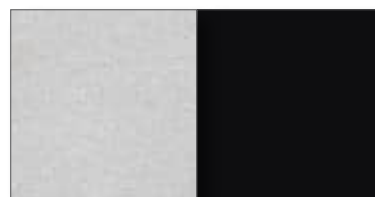

442
BIANCO/PELTRO BRONZATO
WHITE/BRONZE PEWTER

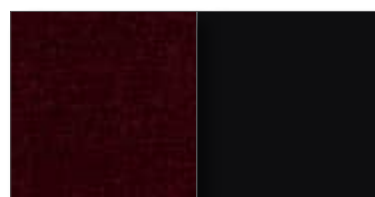

451
BORDEAUX/PELTRO BRONZATO
BURGUNDY/BRONZE PEWTER

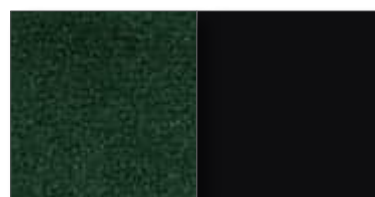

104
VERDE CHIARO/PELTRO BRONZATO
LIGHT GREEN/BRONZE PEWTER



507
VERDE SCURO/PELTRO BRONZATO
DARK GREEN/BRONZE PEWTER



448
BLU SCURO/PELTRO BRONZATO
DARK BLUE/BRONZE PEWTER

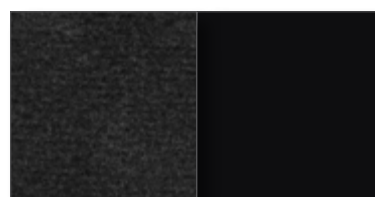

471
GRIGIO SCURO/PELTRO BRONZATO
DARK GREY/BRONZE PEWTER

CATE

822 COTONE VENEZIA/ALLUMINIO LUCIDATO - COTTON VENEZIA/POLISHED ALUMINUM

Lou Speak, Cocky



531
BIANCO/ALLUMINIO
WHITE/ALUMINUM

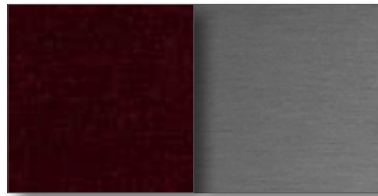

537
BORDEAUX/ALLUMINIO
BURGUNDY/ALUMINUM

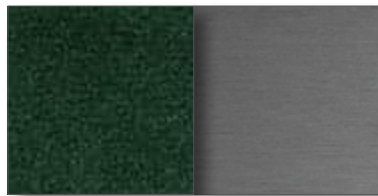

584
VERDE CHIARO/ALLUMINIO
LIGHT GREEN/ALUMINUM



585
VERDE SCURO/ALLUMINIO
DARK GREEN/ALUMINUM

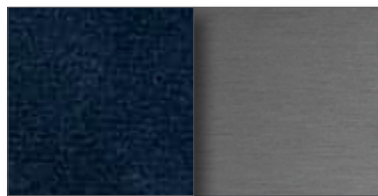

534
BLU SCURO/ALLUMINIO
DARK BLUE/ALUMINUM

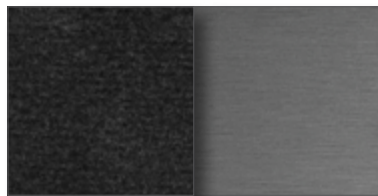

554
GRIGIO SCURO/ALLUMINIO
DARK GREY/ALUMINUM

CATE

823 COTONE VENEZIA/ALLUMINIO VERNICIATO - COTTON VENEZIA/PAINTED ALUMINUM

Lirica, Lirico



596
BIANCO/NERO
WHITE/BLACK



722
BIANCO/ARGENTO
WHITE/SILVER

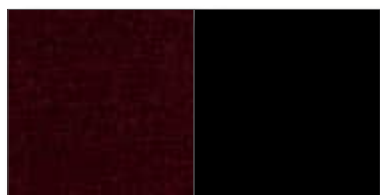

605
BORDEAUX/NERO
BURGUNDY/BLACK



731
BORDEAUX/ARGENTO
BURGUNDY/SILVER



657
VERDE CHIARO/NERO
LIGHT GREEN/BLACK



784
VERDE CHIARO/ARGENTO
LIGHT GREEN/SILVER



661
VERDE SCURO/NERO
DARK GREEN/BLACK



788
VERDE SCURO/ARGENTO
DARK GREEN/SILVER



602
BLU SCURO/NERO
DARK BLUE/BLACK

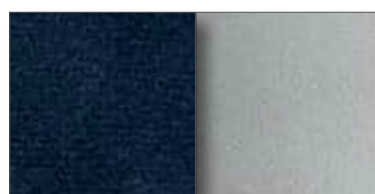

728
BLU SCURO/ARGENTO
DARK BLUE/SILVER

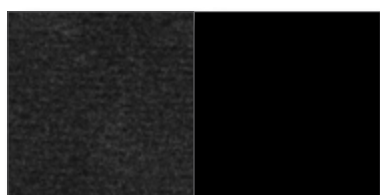

625
GRIGIO SCURO/NERO
DARK GREY/BLACK



751
GRIGIO SCURO/ARGENTO
DARK GREY/SILVER

CATE

826 COTONE VENEZIA/FAGGIO LACCATO - COTTON VENEZIA/LACQUERED BEECH

S.Marco, S.Marco Lounge



596
BIANCO/NERO
WHITE/BLACK



605
BORDEAUX/NERO
BURGUNDY/BLACK



657
VERDE CHIARO/NERO
LIGHT GREEN/BLACK



661
VERDE SCURO/NERO
DARK GREEN/BLACK



602
BLU SCURO/NERO
DARK BLUE/BLACK

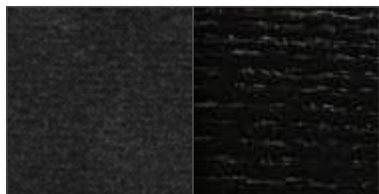

625
VERDE SCURO/NERO
DARK GREEN/BLACK

CATE

827 PU RIGIDO VERNICIATO/COTONE VENEZIA/ACCIAIO CROMATO
STIFF PAINTED PU/COTTON VENEZIA/CHROMED STEEL

Moon

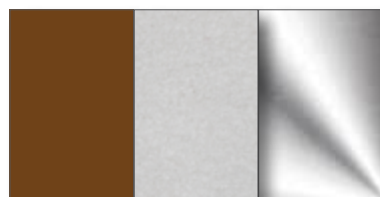

864
MATTONE/BIANCO/CROMO
RED BRICK/WHITE/CHROME



936
ECRU'/BIANCO/CROMO
ECRU'/WHITE/CHROME

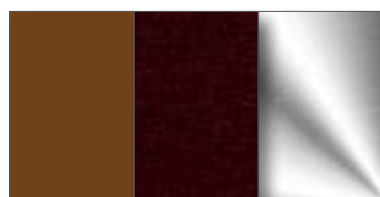

872
MATTONE/BORDEAUX/CROMO
RED BRICK/BURGUNDY/CHROME

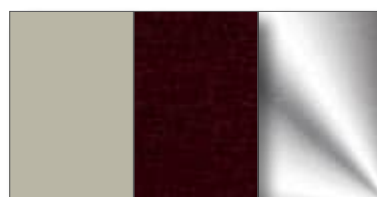

944
ECRU'/BORDEAUX/CROMO
ECRU'/BURGUNDY/CHROME

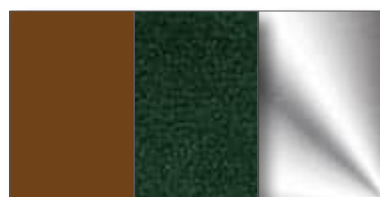

922
MATTONE/VERDE CHIARO/CROMO
RED BRICK/LIGHT GREEN/CHROME

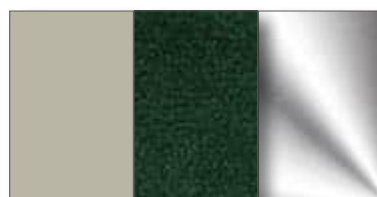

994
ECRU'/VERDE CHIARO/CROMO
ECRU'/LIGHT GREEN/CHROME



926
MATTONE/VERDE SCURO/CROMO
RED BRICK/DARK GREEN/CHROME

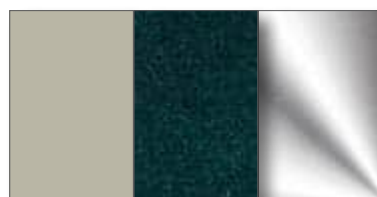

998
ECRU'/VERDE SCURO/CROMO
ECRU'/DARK GREEN/CHROME



869
MATTONE/BLU SCURO/CROMO
RED BRICK/DARK BLUE/CHROME

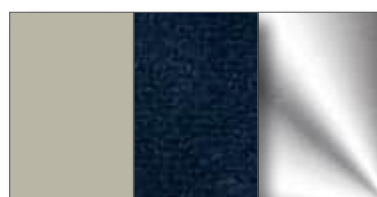

941
ECRU'/BLU SCURO/CROMO
ECRU'/DARK BLUE/CHROME

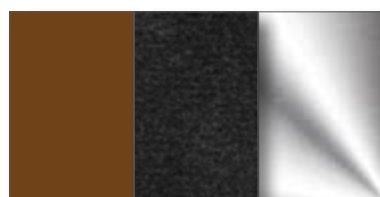

891
MATTONE/GRIGIO SCURO/CROMO
RED BRICK/DARK GREY/CHROME

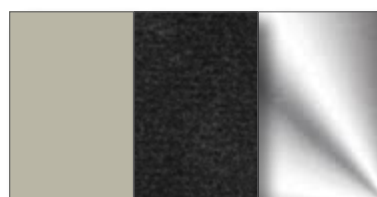

963
ECRU'/GRIGIO SCURO/CROMO
ECRU'/DARK GREY/CHROME

CATE

827 PU RIGIDO VERNICIATO/COTONE VENEZIA/ACCIAIO CROMATO
 STIFF PAINTED PU/COTTON VENEZIA/CHROMED STEEL

Moon

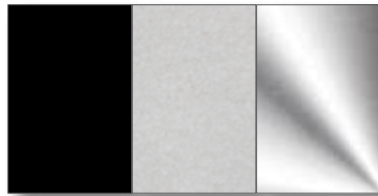

A08
 NERO/BIANCO/CROMO
 BLACK/WHITE/CHROME

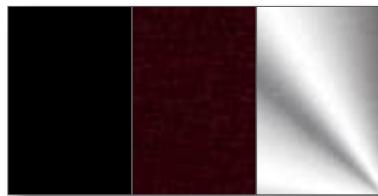

A16
 NERO/BORDEAUX/CROMO
 BLACK/BURGUNDY/CHROME



A66
 NERO/VERDE CHIARO/CROMO
 BLACK/LIGHT GREEN/CHROME



A70
 NERO/VERDE SCURO/CROMO
 BLACK/DARK GREEN/CHROME

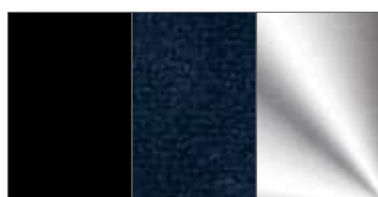

A13
 NERO/BLU SCURO/CROMO
 BLACK/DARK BLUE/CHROME

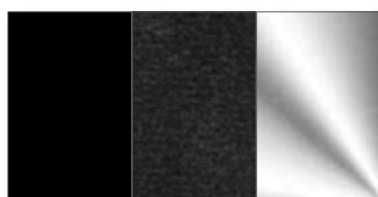

A35
 NERO/GRIGIO SCURO/CROMO
 BLACK/DARK GREY/CHROME

CATE

879 COTONE VENEZIA/ACCIAIO CROMATO - COTTON VENEZIA/CROMED STEEL

Cocky

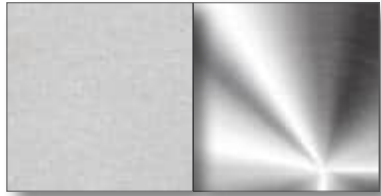

B00
BIANCO/CROMO
WHITE/CHROME

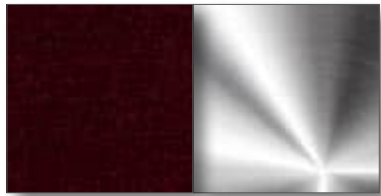

C41
BORDEAUX/CROMO
BURGUNDY/CHROME

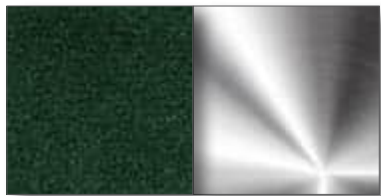

H29
VERDE CHIARO/CROMO
LIGHT GREEN/CHROME

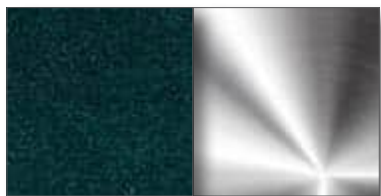

C63
VERDE SCURO/CROMO
DARK GREEN/CHROME



F61
BLU SCURO/CROMO
DARK BLUE/CHROME

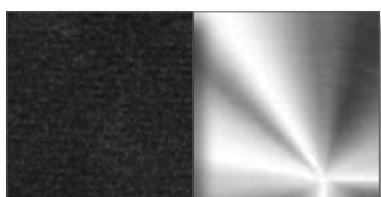

C47
GRIGIO SCURO/CROMO
DARK GREY/CHROME

CATE

717 MODACRILICA POLIESTERE PECHINO - MODACRYLIC POLYESTER PECHINO

Composizione/Composition: 85% MA, 15% PL. Altezza/Height: 145 cm. Peso/Weight: 1000gr.



002
BIANCO
WHITE



091
NERO
BLACK

I colori sono indicativi. Non è possibile garantire uniformità di tono nella tintura dei lotti di tessuto. Resta inteso che lievi differenze di colore verranno accettate al momento dell'ordine.

The colors are just indicative. Actually a steady tone of lots cannot be guaranteed. It remains understood that any slight colour difference will be accepted in case an order is placed.

CATE

840 MODACRILICA POLIESTERE PECHINO/ACCIAIO VERNICIATO -
MODACRYLIC POLYESTER PECHINO/PAINTED STEEL

Cocky

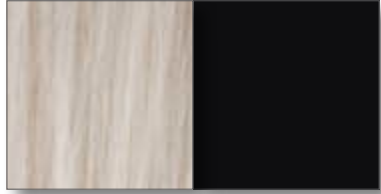

596
BIANCO/NERO
WHITE/BLACK

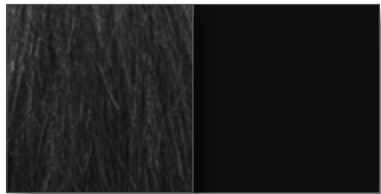

632
NERO/NERO
BLACK/BLACK

CATE

841 MODACRILICA POLIESTERE PECHINO/ALLUMINIO LUCIDATO -
MODACRYLIC POLYESTER PECHINO/POLISHED ALUMINUM

Cocky

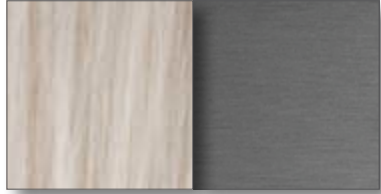

531

BIANCO/ALLUMINIO
WHITE/ALUMINUM



561

NERO/ALLUMINIO
BLACK/ALUMINUM

CATE

846 PU RIGIDO VERNICIATO/MODACRILICA POLIESTERE PECHINO/ACCIAIO CROMATO
STIFF PAINTED PU/MODACRYLIC POLYESTER PECHINO/CHROMED STEEL

Moon



864
MATTONE/BIANCO/CROMO
RED BRICK/WHITE/CHROME

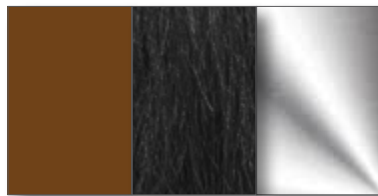

899
MATTONE/NERO/CROMO
RED BRICK/BLACK/CHROME

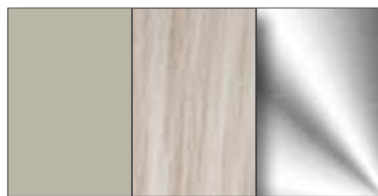

936
ECRU/BIANCO/CROMO
ECRU/WHITE/CHROME

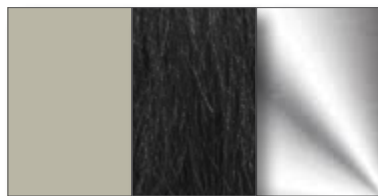

971
ECRU/NERO/CROMO
ECRU/BLACK/CHROME



A08
NERO/BIANCO/CROMO
BLACK/WHITE/CHROME

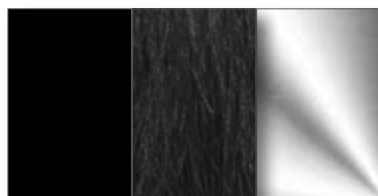

A43
NERO/NERO/CROMO
BLACK/BLACK/CHROME

CATE

880 MODACRILICA POLIESTERE PECHINO/ACCIAIO CROMATO -
MODACRYLIC POLYESTER PECHINO/CROMED STEEL

Cocky



B00
BIANCO/CROMO
WHITE/CHROME

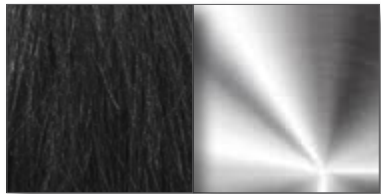

B01
NERO/CROMO
BLACK/CHROME

CATE

718 MODACRILICA POLIESTERE MONGOLIA - MODACRYLIC POLYESTER MONGOLIA

Composizione/Composition: 82% MA, 18% PL. Altezza/Height: 145 cm. Peso/Weight: 950gr.



002
BIANCO
WHITE



091
NERO
BLACK

I colori sono indicativi. Non è possibile garantire uniformità di tono nella tintura dei lotti di tessuto. Resta inteso che lievi differenze di colore verranno accettate al momento dell'ordine.

The colors are just indicative. Actually a steady tone of lots cannot be guaranteed. It remains understood that any slight colour difference will be accepted in case an order is placed.

CATE

849 MODACRILICA POLIESTERE MONGOLIA/ACCIAIO VERNICIATO -
MODACRYLIC POLYESTER MONGOLIA/PAINTED STEEL

Cocky

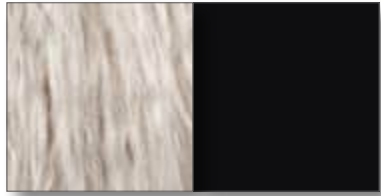

596
BIANCO/NERO
WHITE/BLACK

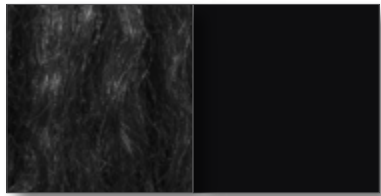

632
NERO/NERO
BLACK/BLACK

CATE

850 MODACRILICA POLIESTERE MONGOLIA/ALLUMINIO LUCIDATO -
MODACRYLIC POLYESTER MONGOLIA/POLISHED ALUMINUM

Cocky

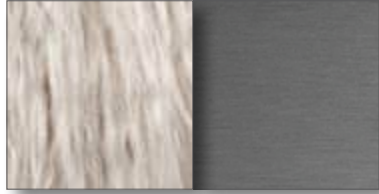

531

BIANCO/ALLUMINIO
WHITE/ALUMINUM



561

NERO/ALLUMINIO
BLACK/ALUMINUM

CATE

881 MODACRILICA POLIESTERE MONGOLIA/ACCIAIO CROMATO -
MODACRYLIC POLYESTER MONGOLIA/CROMED STEEL

Cocky

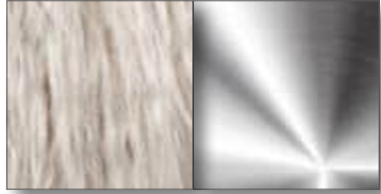

B00
BIANCO/CROMO
WHITE/CHROME



B01
NERO/CROMO
BLACK/CHROME

CAT.P

050 PELLE NIAGARA - LEATHER NIAGARA

Chrome tanning bovine raw hides, pigmented, corrected grain, aniline through dyed. Thickness: 1.4/1.6 mm; BS5852 Source 0 and Source 1

PULIRE SOLO CON PANNINO UMIDO E DETERGENTE NEUTRO/CLEAN ONLY WITH A DAMP CLOTH AND A NEUTRAL DETERGENT



002
BIANCO
WHITE



015
BEIGE
BEIGE



003
POLVERE
DUSTY



011
SABBIA
SAND



021
GIALLO
YELLOW



033
ARANCIO
ORANGE

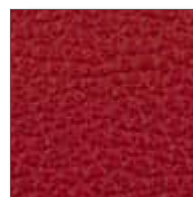

039
ROSSO
RED

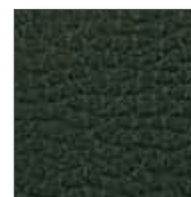

E21
COCCO
COCONUT



090
AVANA
HAVANA



081
MARRONE
BROWN



044
GRIGIO
GREY

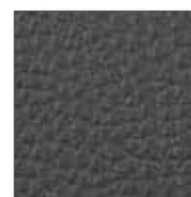

050
GRIGIO SCURO
DARK GREY



091
NERO
BLACK

I colori sono indicativi. Non è possibile garantire uniformità di tono nella tintura dei lotti di tessuto. Resta inteso che lievi differenze di colore verranno accettate al momento dell'ordine.

The colors are just indicative. Actually a steady tone of lots cannot be guaranteed. It remains understood that any slight colour difference will be accepted in case an order is placed.

CAT.P

079 PELLE NIAGARA/FRASSINO - LEATHER NIAGARA/ASH

La Francesca, Meridiana



177
BIANCO/NATURALE
WHITE/NATURAL



F13
COCCO/NATURALE
COCONUT/NATURAL



176
BEIGE/NATURALE
BEIGE/NATURAL

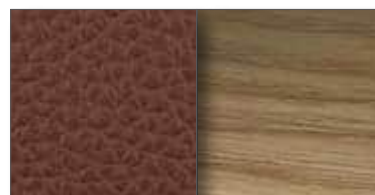

171
AVANA/NATURALE
HAVANA/NATURAL



213
POLVERE/NATURALE
DUSTY/NATURAL



206
MARRONE/NATURALE
BROWN/NATURAL



221
SABBIA/NATURALE
SAND/NATURAL



192
GRIGIO/NATURALE
GREY/NATURAL



190
GIALLO/NATURALE
YELLOW/NATURAL

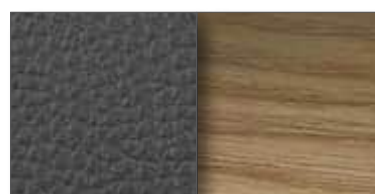

191
GRIGIO SCURO/NATURALE
DARK GREY/NATURAL



170
ARANCIO/NATURALE
ORANGE/NATURAL

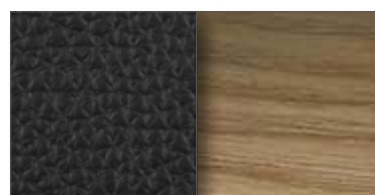

207
NERO/NATURALE
BLACK/NATURAL

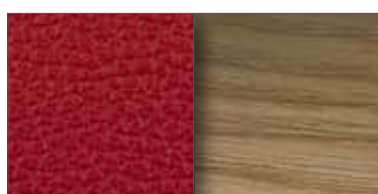

219
ROSSO/NATURALE
RED/NATURAL

CAT.P

079 PELLE NIAGARA/FRASSINO - LEATHER NIAGARA/ASH

La Francesea

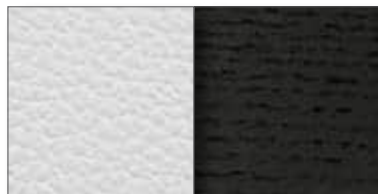

230
BIANCO/EBANIZZATO
WHITE/EBONIZED

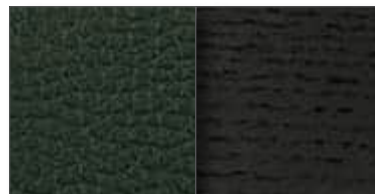

F14
COCO/EBANIZZATO
COCONUT/EBONIZED



237
BEIGE/EBANIZZATO
BEIGE/EBONIZED

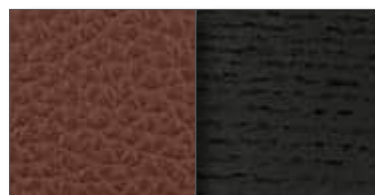

232
AVANA/EBANIZZATO
HAVANA/EBONIZED

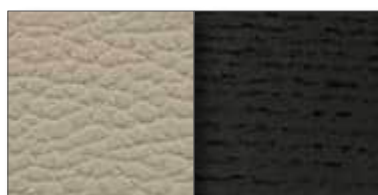

274
POLVERE/EBANIZZATO
DUSTY/EBONIZED

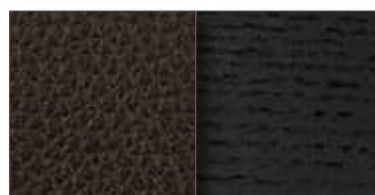

266
MARRONE/EBANIZZATO
BROWN/EBONIZED

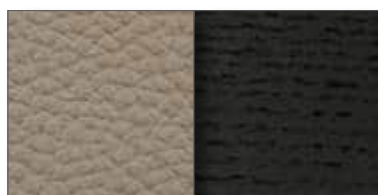

282
SABBIA/EBANIZZATO
SAND/EBONIZED



251
GRIGIO/EBANIZZATO
GREY/EBONIZED



250
GIALLO/EBANIZZATO
YELLOW/EBONIZED



260
GRIGIO SCURO/EBANIZZATO
DARK GREY/EBONIZED

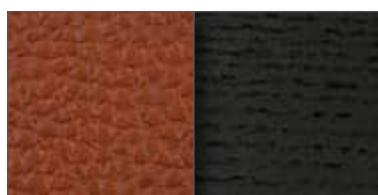

231
ARANCIO/EBANIZZATO
ORANGE/EBONIZED

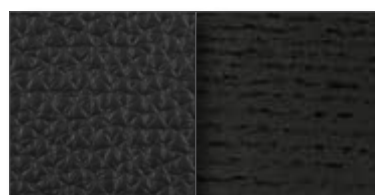

267
NERO/EBANIZZATO
BLACK/EBONIZED

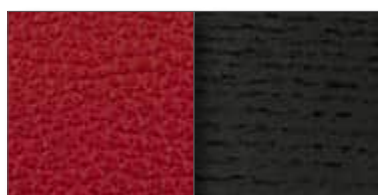

280
ROSSO/EBANIZZATO
RED/EBONIZED

CAT.P

148 PELLE NIAGARA/ACCIAIO VERNICIATO - LEATHER NIAGARA/PAINTED STEEL

Costes

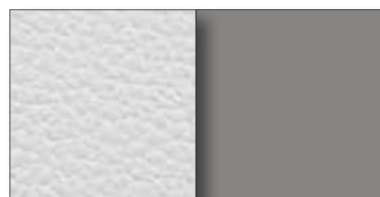

297
BIANCO/TITANIO
WHITE/TITANIUM

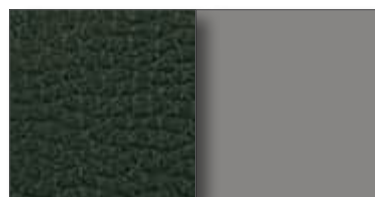

F15
COCCO/TITANIO
COCONUT/TITANIUM

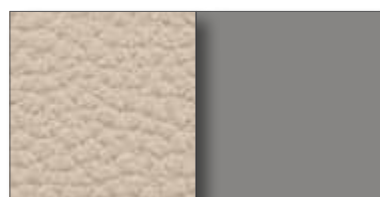

296
BEIGE/TITANIO
BEIGE/TITANIUM

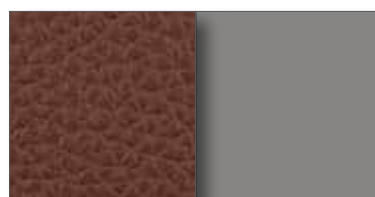

293
AVANA/TITANIO
HAVANA/TITANIUM

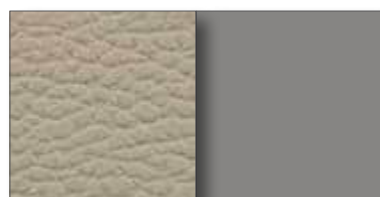

313
POLVERE/TITANIO
DUSTY/TITANIUM



310
MARRONE/TITANIO
BROWN/TITANIUM

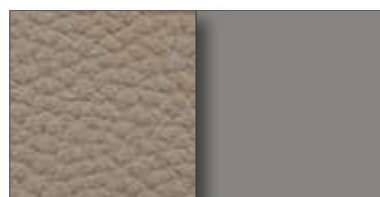

315
SABBIA/TITANIO
SAND/TITANIUM

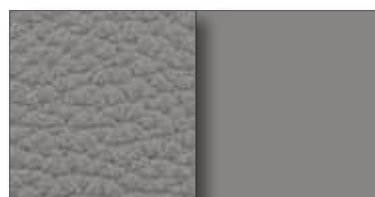

305
GRIGIO/TITANIO
GREY/TITANIUM

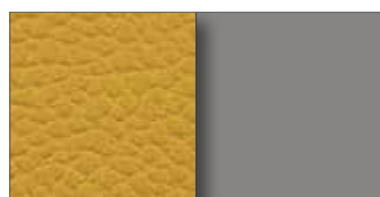

303
GIALLO/TITANIO
YELLOW/TITANIUM

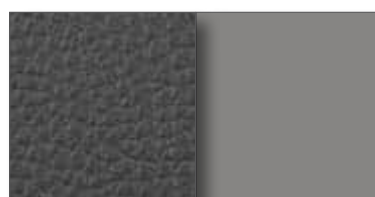

304
GRIGIO SCURO/TITANIO
DARK GREY/TITANIUM

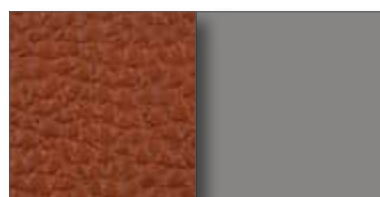

292
ARANCIO/TITANIO
ORANGE/TITANIUM

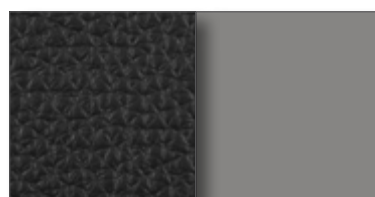

311
NERO/TITANIO
BLACK/TITANIUM

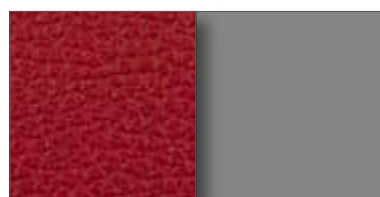

314
ROSSO/TITANIO
RED/TITANIUM

CAT.P

153 PELLE NIAGARA MICROFORATA/ACCIAIO VERNICIATO -
LEATHER NIAGARA MICROPERFORATED/PAINTED STEEL

Sof Sof

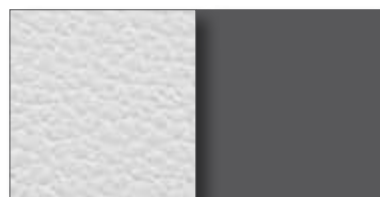

328
BIANCO/GRAFITE
WHITE/GRAPHITE

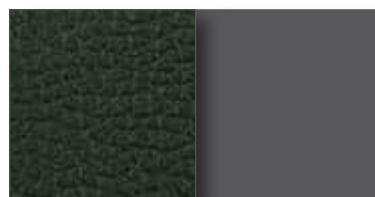

F16
COCCO/GRAFITE
COCONUT/GRAPHITE

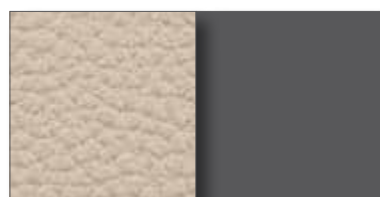

327
BEIGE/GRAFITE
BEIGE/GRAPHITE

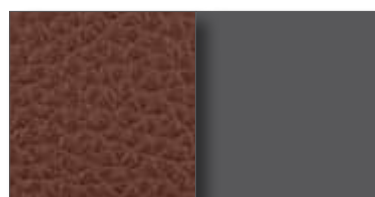

321
AVANA/GRAFITE
HAVANA/GRAPHITE

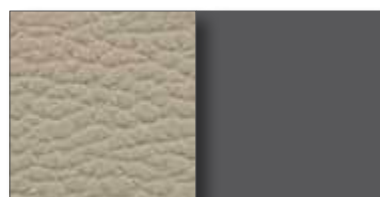

F12
POLVERE/GRAFITE
DUSTY/GRAPHITE



360
MARRONE/GRAFITE
BROWN/GRAPHITE

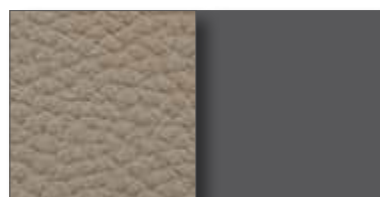

377
SABBIA/GRAFITE
SAND/GRAPHITE

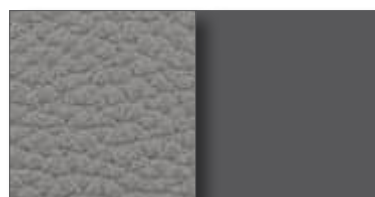

343
GRIGIO/GRAFITE
GREY/GRAPHITE

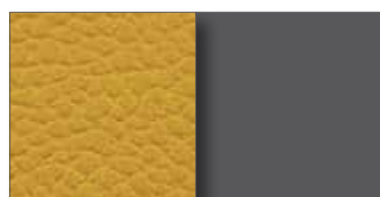

342
GIALLO/GRAFITE
YELLOW/GRAPHITE

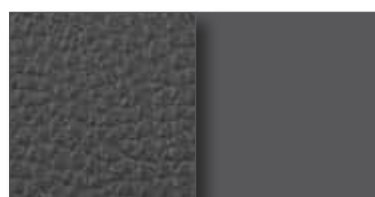

353
GRIGIO SCURO/GRAFITE
DARK GREY/GRAPHITE

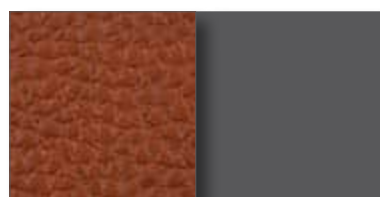

320
ARANCIO/GRAFITE
ORANGE/GRAPHITE

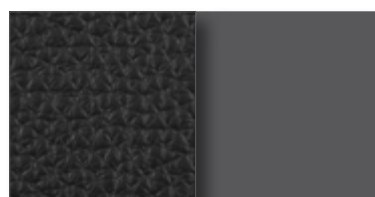

361
NERO/GRAFITE
BLACK/GRAPHITE

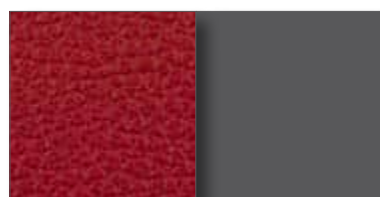

374
ROSSO/GRAFITE
RED/GRAPHITE

CAT.P

148 PELLE NIAGARA/ACCIAIO VERNICIATO -
LEATHER NIAGARA/PAINTED STEEL

Elisa

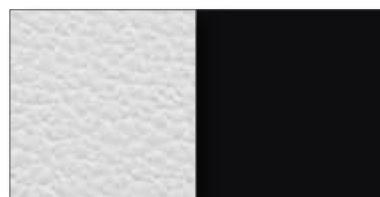

393
BIANCO/NERO MARRONE
WHITE/BLACK BROWN

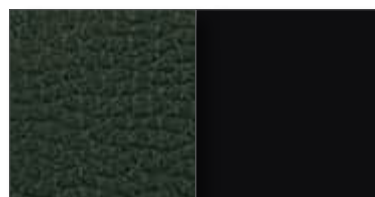

G51
COCCO/NERO MARRONE
COCONUT/BLACK BROWN

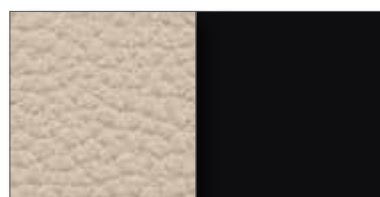

392
BEIGE/NERO MARRONE
BEIGE/BLACK BROWN

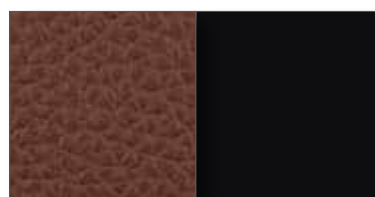

G53
AVANA/NERO MARRONE
HAVANA/BLACK BROWN

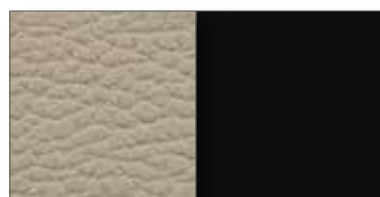

G50
POLVERE/NERO MARRONE
DUSTY/BLACK BROWN



416
MARRONE/NERO MARRONE
BROWN/BLACK BROWN

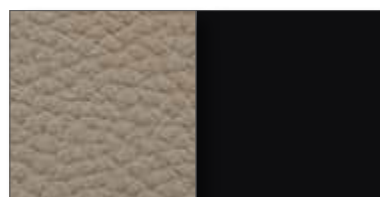

426
SABBIA/NERO MARRONE
SAND/BLACK BROWN

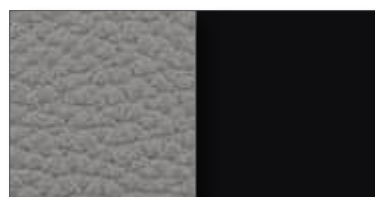

404
GRIGIO/NERO MARRONE
GREY/BLACK BROWN

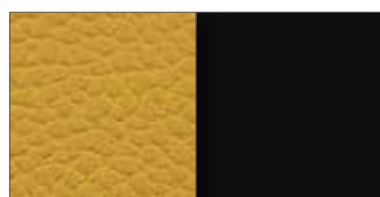

E29
GIALLO/NERO MARRONE
YELLOW/BLACK BROWN

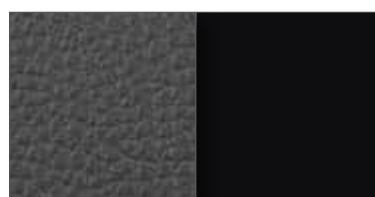

411
GRIGIO SCURO/NERO MARRONE
DARK GREY/BLACK BROWN

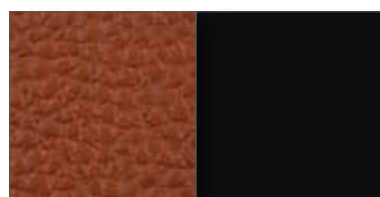

387
ARANCIO/NERO MARRONE
ORANGE/BLACK BROWN

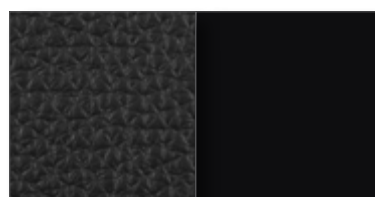

417
NERO/NERO MARRONE
BLACK/BLACK BROWN

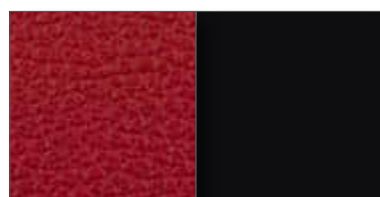

424
ROSSO/NERO MARRONE
RED/BLACK BROWN

CAT.P

148 PELLE NIAGARA/ACCIAIO VERNICIATO - LEATHER NIAGARA/PAINTED STEEL

Meridiana, Cocky

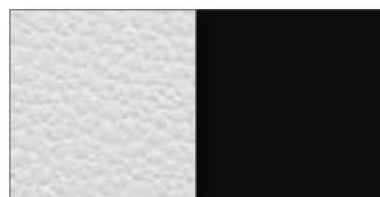

596
BIANCO/NERO
WHITE/BLACK

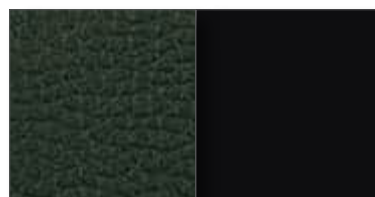

F17
COCCO/NERO
COCONUT/BLACK

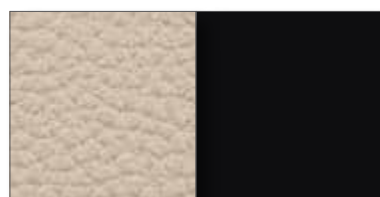

595
BEIGE/NERO
BEIGE/BLACK

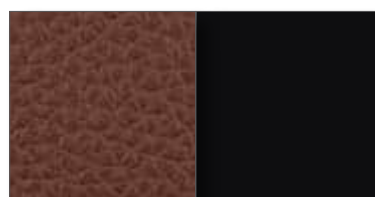

589
AVANA/NERO
HAVANA/BLACK

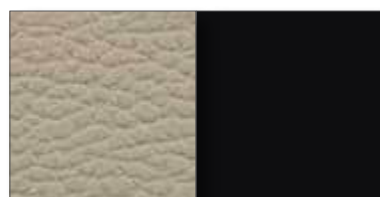

640
POLVERE/NERO
DUSTY/BLACK



631
MARRONE/NERO
BROWN/BLACK

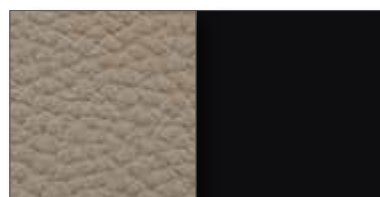

651
SABBIA/NERO
SAND/BLACK

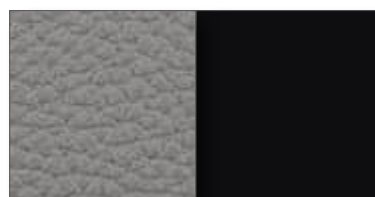

615
GRIGIO/NERO
GREY/BLACK

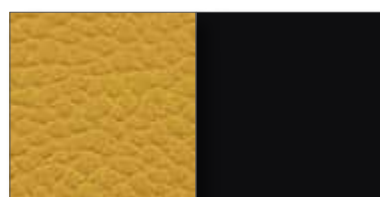

614
GIALLO/NERO
YELLOW/BLACK

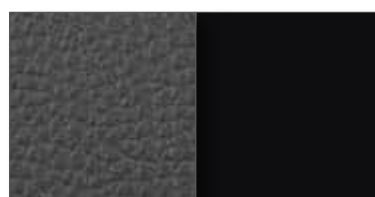

625
GRIGIO SCURO/NERO
DARK GREY/BLACK

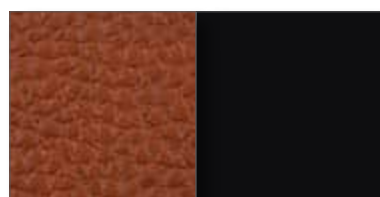

588
ARANCIO/NERO
ORANGE/BLACK

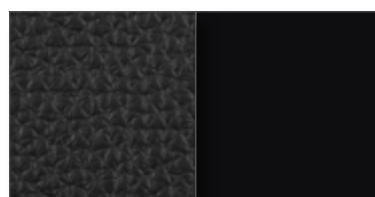

632
NERO/NERO
BLACK/BLACK

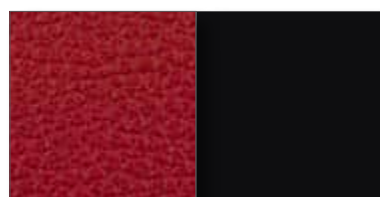

647
ROSSO/NERO
RED/BLACK

CAT.P

148 PELLE NIAGARA/ACCIAIO VERNICIATO - LEATHER NIAGARA/PAINTED STEEL

Fenix



442
BIANCO/PELTRO BRONZATO
WHITE/BRONZE PEWTER



F19
COCCO/PELTRO BRONZATO
COCONUT/BRONZE PEWTER



441
BEIGE/PELTRO BRONZATO
BEIGE/BRONZE PEWTER



435
AVANA/PELTRO BRONZATO
HAVANA/BRONZE PEWTER



487
POLVERE/PELTRO BRONZATO
DUSTY/BRONZE PEWTER



478
MARRONE/PELTRO BRONZATO
BROWN/BRONZE PEWTER

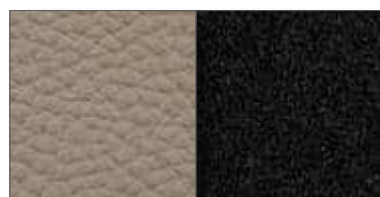

498
SABBIA/PELTRO BRONZATO
SAND/BRONZE PEWTER



461
GRIGIO/PELTRO BRONZATO
GREY/BRONZE PEWTER



460
GIALLO/PELTRO BRONZATO
YELLOW/BRONZE PEWTER



471
GRIGIO SCURO/PELTRO BRONZATO
DARK GREY/BRONZE PEWTER



434
ARANCIO/PELTRO BRONZATO
ORANGE/BRONZE PEWTER

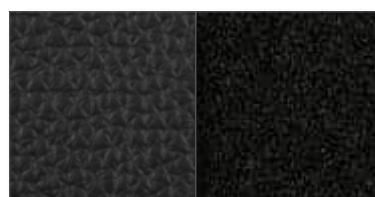

479
NERO/PELTRO BRONZATO
BLACK/BRONZE PEWTER

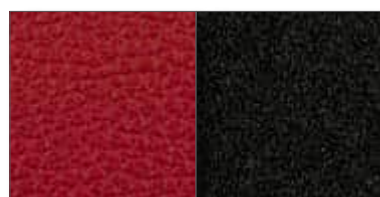

494
ROSSO/PELTRO BRONZATO
RED/BRONZE PEWTER

CAT.P

184 PELLE NIAGARA/ACCIAIO CROMATO - LEATHER NIAGARA/CROMED STEEL

Meridiana, Moon, Cocky

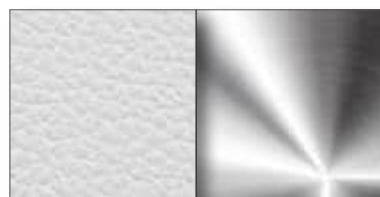

B00
BIANCO/CROMO
WHITE/CHROME



F20
COCCO/CROMO
COCONUT/CHROME



C38
BEIGE/CROMO
BEIGE/CHROME



C35
AVANA/CROMO
HAVANA/CHROME



C57
POLVERE/CROMO
DUSTY/CHROME



C54
MARRONE/CROMO
BROWN/CHROME



C59
SABBIA/CROMO
SAND/CHROME

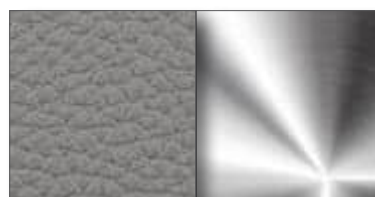

C48
GRIGIO/CROMO
GREY/CHROME



C46
GIALLO/CROMO
YELLOW/CHROME



C47
GRIGIO SCURO/CROMO
DARK GREY/CHROME



C34
ARANCIO/CROMO
ORANGE/CHROME

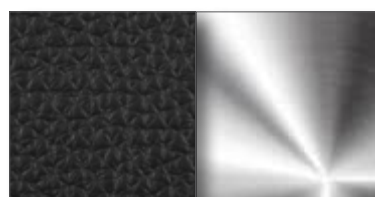

B01
NERO/CROMO
BLACK/CHROME



C58
ROSSO/CROMO
RED/CHROME

CAT.P

213 PELLE NIAGARA/ALLUMINIO LUCIDATO -
LEATHER NIAGARA/POLISHED ALUMINUM

Lou Speak, Cocky

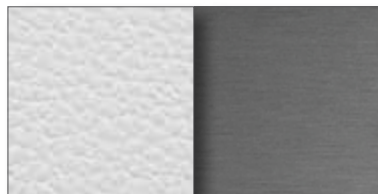

531
BIANCO/ALLUMINIO
WHITE/ALUMINUM

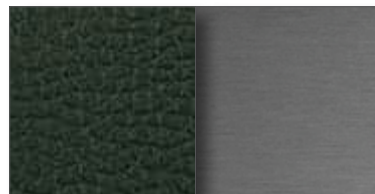

F21
COCCO/ALLUMINIO
COCONUT/ALUMINUM

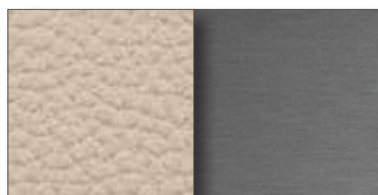

530
BEIGE/ALLUMINIO
BEIGE/ALUMINUM

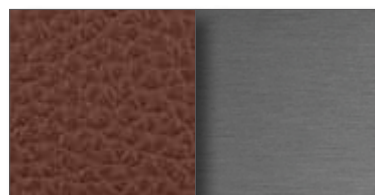

525
AVANA/ALLUMINIO
HAVANA/ALUMINUM

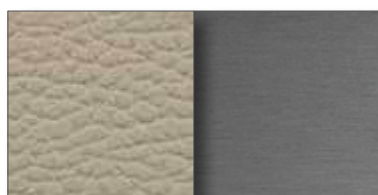

569
POLVERE/ALLUMINIO
DUSTY/ALUMINUM



560
MARRONE/ALLUMINIO
BROWN/ALUMINUM

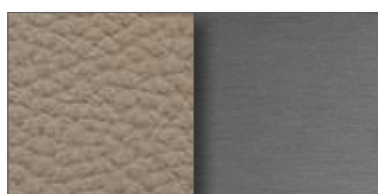

578
SABBIA/ALLUMINIO
SAND/ALUMINUM

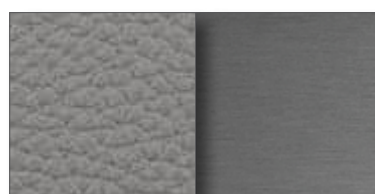

545
GRIGIO/ALLUMINIO
GREY/ALUMINUM

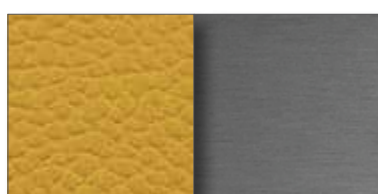

544
GIALLO/ALLUMINIO
YELLOW/ALUMINUM

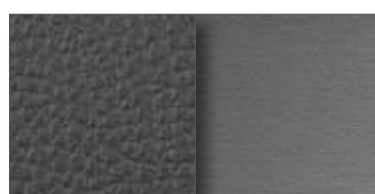

554
GRIGIO SCURO/ALLUMINIO
DARK GREY/ALUMINUM

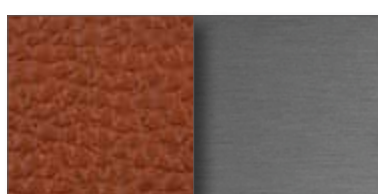

524
ARANCIO/ALLUMINIO
ORANGE/ALUMINUM

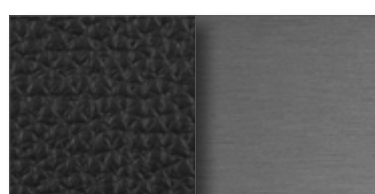

561
NERO/ALLUMINIO
BLACK/ALUMINUM

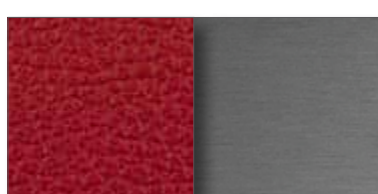

575
ROSSO/ALLUMINIO
RED/ALUMINUM

CAT.P

242 PELLE NIAGARA/ALLUMINIO VERNICIATO -
LEATHER NIAGARA/PAINTED ALUMINUM

Lirica, Lirico

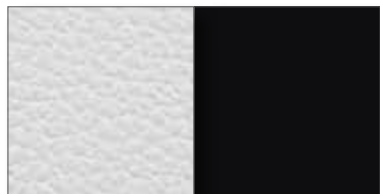

596
BIANCO/NERO
WHITE/BLACK

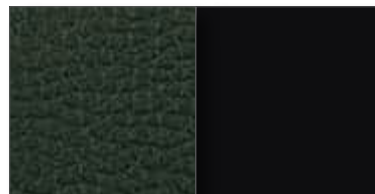

F17
COCCO/NERO
COCONUT/BLACK

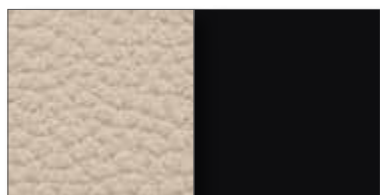

595
BEIGE/NERO
BEIGE/BLACK

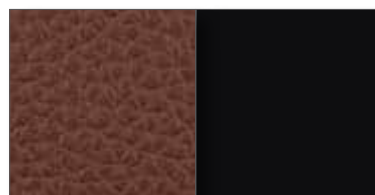

589
AVANA/NERO
HAVANA/BLACK

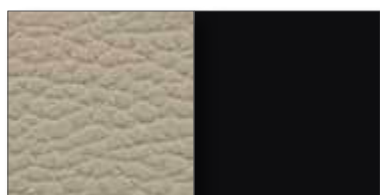

640
POLVERE/NERO
DUSTY/BLACK



631
MARRONE/NERO
BROWN/BLACK

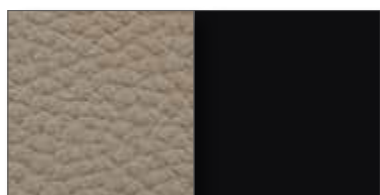

651
SABBIA/NERO
SAND/BLACK

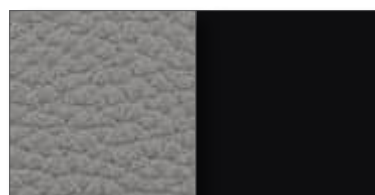

615
GRIGIO/NERO
GREY/BLACK

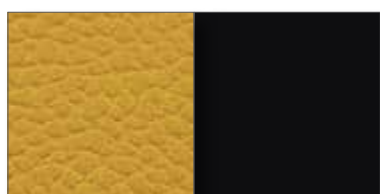

614
GIALLO/NERO
YELLOW/BLACK

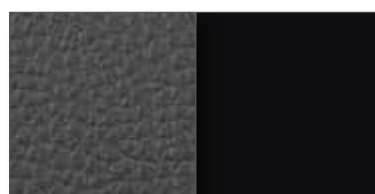

625
GRIGIO SCURO/NERO
DARK GREY/BLACK

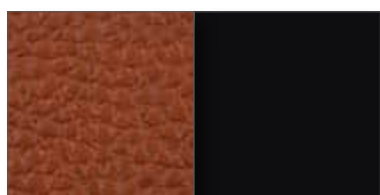

588
ARANCIO/NERO
ORANGE/BLACK

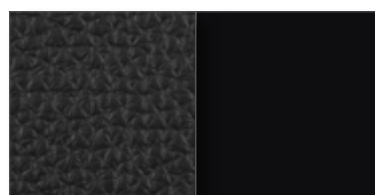

632
NERO/NERO
BLACK/BLACK

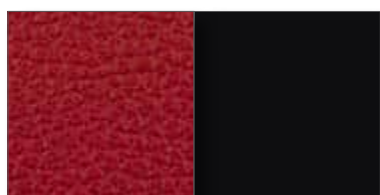

647
ROSSO/NERO
RED/BLACK

CAT.P

242 PELLE NIAGARA/ALLUMINIO VERNICIATO -
LEATHER NIAGARA/PAINTED ALUMINUM

Lirica, Lirico



722
BIANCO/ARGENTO
WHITE/SILVER



F22
COCCO/ARGENTO
COCONUT/SILVER

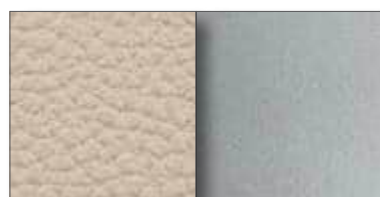

721
BEIGE/ARGENTO
BEIGE/SILVER

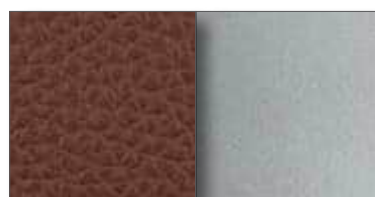

715
AVANA/ARGENTO
HAVANA/SILVER



767
POLVERE/ARGENTO
DUSTY/SILVER



758
MARRONE/ARGENTO
BROWN/SILVER



778
SABBIA/ARGENTO
SAND/SILVER



741
GRIGIO/ARGENTO
GREY/SILVER



740
GIALLO/ARGENTO
YELLOW/SILVER



751
GRIGIO SCURO/ARGENTO
DARK GREY/SILVER



714
ARANCIO/ARGENTO
ORANGE/SILVER

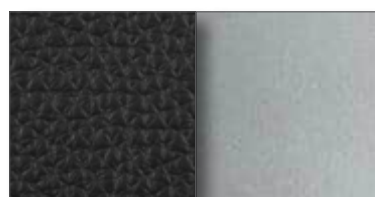

759
NERO/ARGENTO
BLACK/SILVER

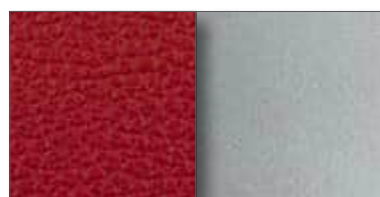

774
ROSSO/ARGENTO
RED/SILVER

CAT.P

335 PELLE NIAGARA/FAGGIO LACCATO - LEATHER NIAGARA/LACQUERED BEECH

S.Marco, S.Marco Lounge

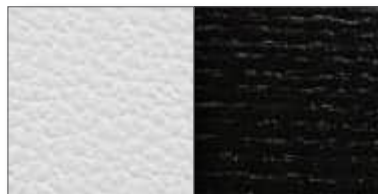

596
BIANCO/NERO
WHITE/BLACK

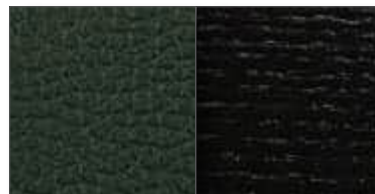

F17
COCCO/NERO
COCONUT/BLACK



595
BEIGE/NERO
BEIGE/BLACK



589
AVANA/NERO
HAVANA/BLACK



640
POLVERE/NERO
DUSTY/BLACK

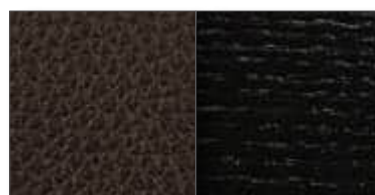

631
MARRONE/NERO
BROWN/BLACK



651
SABBIA/NERO
SAND/BLACK



615
GRIGIO/NERO
GREY/BLACK



614
GIALLO/NERO
YELLOW/BLACK



625
GRIGIO SCURO/NERO
DARK GREY/BLACK



588
ARANCIO/NERO
ORANGE/BLACK

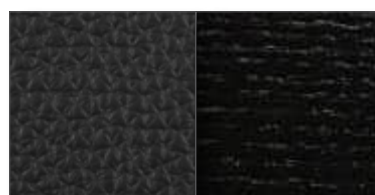

632
NERO/NERO
BLACK/BLACK

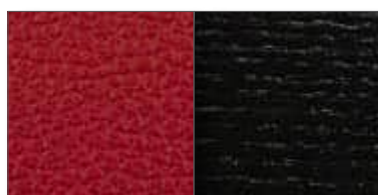

647
ROSSO/NERO
RED/BLACK

CAT.P

417 PU RIGIDO VERNICIATO/PELLE NIAGARA/ACCIAIO CROMATO
STIFF PAINTED PU/LEATHER NIAGARA/CHROMED STEEL

Moon

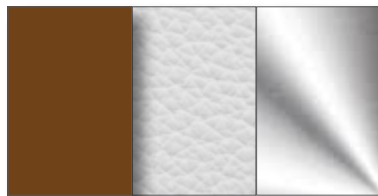

864
MATTONE/BIANCO/CROMO
RED BRICK/WHITE/CHROME

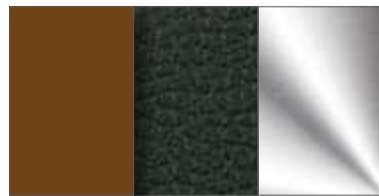

F24
MATTONE/COCCO/CROMO
RED BRICK/COCONUT/CHROME



863
MATTONE/BEIGE/CROMO
RED BRICK/BEIGE/CHROME

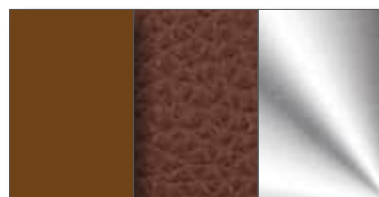

858
MATTONE/AVANA/CROMO
RED BRICK/HAVANA/CHROME



906
MATTONE/POLVERE/CROMO
RED BRICK/DUSTY/CHROME



898
MATTONE/MARRONE/CROMO
RED BRICK/BROWN/CHROME

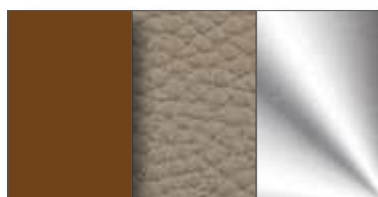

917
MATTONE/SABBIA/CROMO
RED BRICK/SAND/CHROME



881
MATTONE/GRIGIO/CROMO
RED BRICK/GREY/CHROME

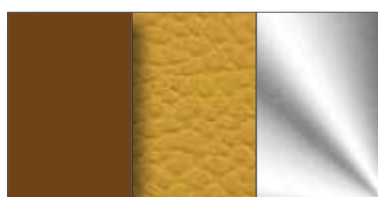

880
MATTONE/GIALLO/CROMO
RED BRICK/YELLOW/CHROME

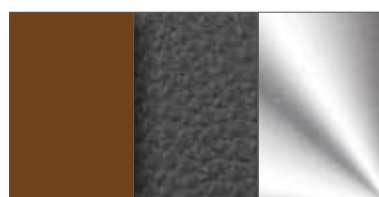

891
MATTONE/GRIGIO SCURO/CROMO
RED BRICK/DARK GREY/CHROME

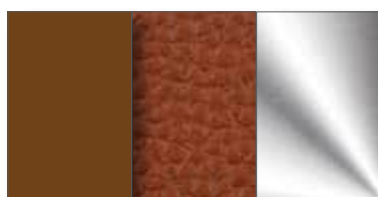

857
MATTONE/ARANCIO/CROMO
RED BRICK/ORANGE/CHROME

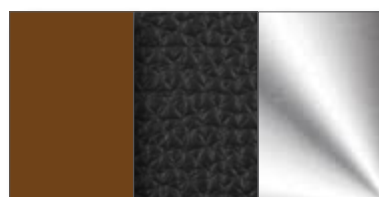

899
MATTONE/NERO/CROMO
RED BRICK/BLACK/CHROME

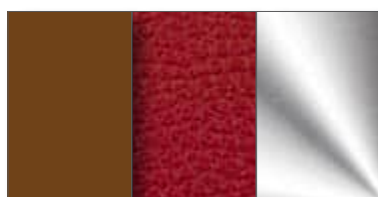

913
MATTONE/ROSSO/CROMO
RED BRICK/RED/CHROME

CAT.P

417 PU RIGIDO VERNICIATO/PELLE NIAGARA/ACCIAIO CROMATO
STIFF PAINTED PU/LEATHER NIAGARA/CHROMED STEEL

Moon

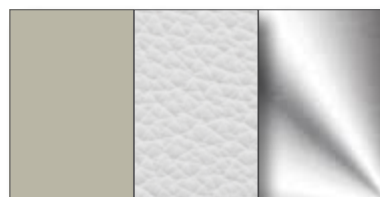

936
ECRU/BIANCO/CROMO
ECRU/WHITE/CHROME

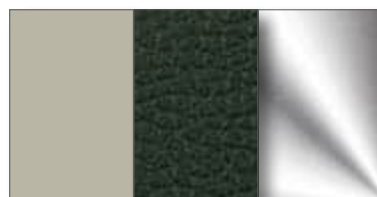

F25
ECRU/COCCO/CROMO
ECRU/COCONUT/CHROME



935
ECRU/BEIGE/CROMO
ECRU/BEIGE/CHROME

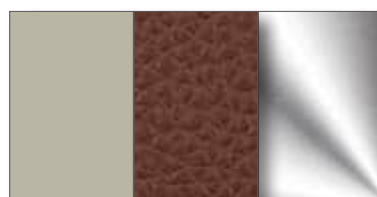

930
ECRU/AVANA/CROMO
ECRU/HAVANA/CHROME



978
ECRU/POLVERE/CROMO
ECRU/DUSTY/CHROME

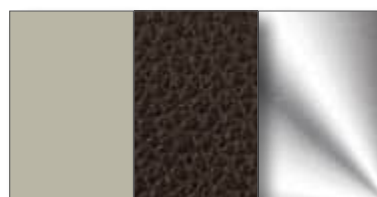

970
ECRU/MARRONE/CROMO
ECRU/BROWN/CHROME



989
ECRU/SABBIA/CROMO
ECRU/SAND/CHROME

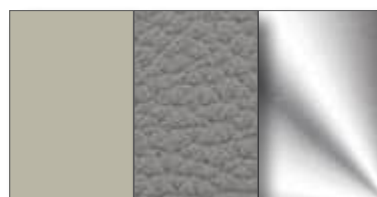

953
ECRU/GRIGIO/CROMO
ECRU/GREY/CHROME

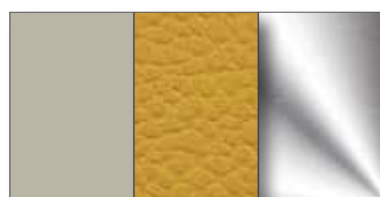

952
ECRU/GIALLO/CROMO
ECRU/YELLOW/CHROME

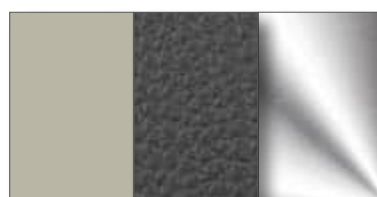

963
ECRU/GRIGIO SCURO/CROMO
ECRU/DARK GREY/CHROME

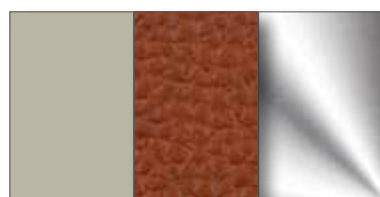

929
ECRU/ARANCIO/CROMO
ECRU/ORANGE/CHROME

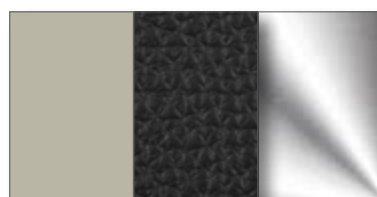

971
ECRU/NERO/CROMO
ECRU/BLACK/CHROME

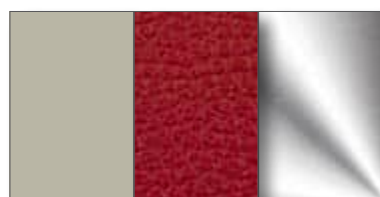

985
ECRU/ROSSO/CROMO
ECRU/RED/CHROME

CAT.P

417 PU RIGIDO VERNICIATO/PELLE NIAGARA/ACCIAIO CROMATO
STIFF PAINTED PU/LEATHER NIAGARA/CHROMED STEEL

Moon

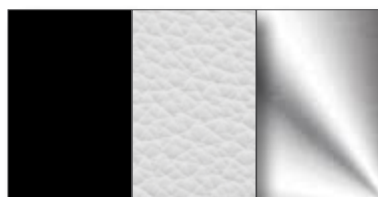

A08
NERO/BIANCO/CROMO
BLACK/WHITE/CHROME

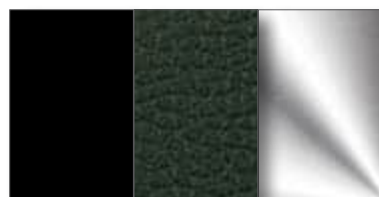

F26
NERO/COCCO/CROMO
BLACK/COCONUT/CHROME

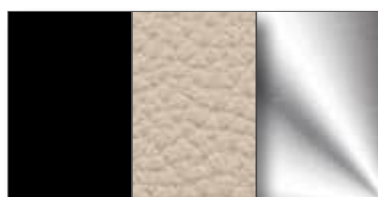

A07
NERO/BEIGE/CROMO
BLACK/BEIGE/CHROME

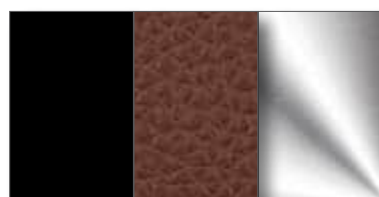

A02
NERO/AVANA/CROMO
BLACK/HAVANA/CHROME

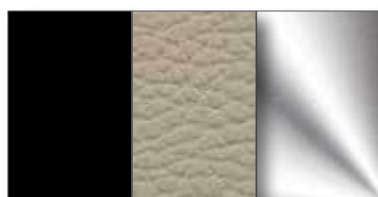

A50
NERO/POLVERE/CROMO
BLACK/DUSTY/CHROME

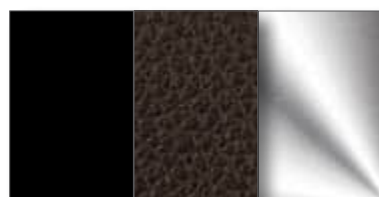

A42
NERO/MARRONE/CROMO
BLACK/BROWN/CHROME

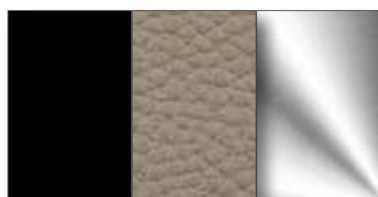

A61
NERO/SABBIA/CROMO
BLACK/SAND/CHROME

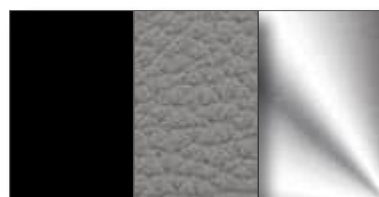

A25
NERO/GRIGIO/CROMO
BLACK/GREY/CHROME

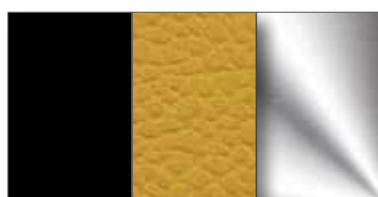

A24
NERO/GIALLO/CROMO
BLACK/YELLOW/CHROME

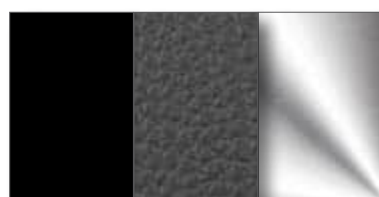

A35
NERO/GRIGIO SCURO/CROMO
BLACK/DARK GREY/CHROME

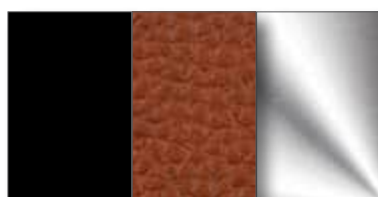

A01
NERO/ARANCIO/CROMO
BLACK/ORANGE/CHROME

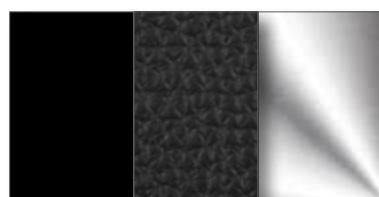

A43
NERO/NERO/CROMO
BLACK/BLACK/CHROME

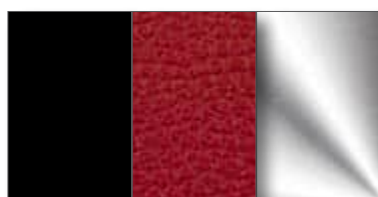

A57
NERO/ROSSO/CROMO
BLACK/RED/CHROME

CAT.O

049 PELLE RIO - *LEATHER RIO*

Chrome tanning, bovine of European origin, lightly buffed natural grain, pigmented and protective coat, with a soft, waxy feel and semi-matt appearance. Thickness: 0.9/1.1 mm; BS5852

PULIRE SOLO CON PANNINO UMIDO E DETERGENTE NEUTRO/CLEAN ONLY WITH A DAMP CLOTH AND A NEUTRAL DETERGENT



002
BIANCO
WHITE



E22
LATTE
MILK



004
AVORIO
IVORY

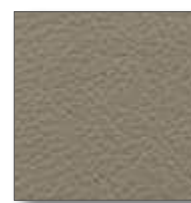

011
SABBIA
SAND



016
TORTORA
TAUPE



021
GIALLO
YELLOW



033
ARANCIO
ORANGE



039
ROSSO
RED



040
BORDEAUX
BURGUNDY



E23
PRUGNA
PLUM

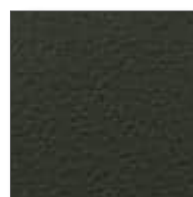

066
VERDE SCURO
DARK GREEN



060
AZZURRO
LIGHT BLUE



072
BLU
BLUE



E20
BLU NOTTE
DARK BLUE



080
MARRONE CHIARO
LIGHT BROWN



083
MARRONE SCURO
DARK BROWN



044
GRIGIO
GREY

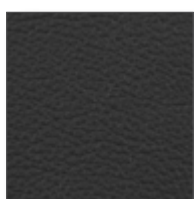

050
GRIGIO SCURO
DARK GREY

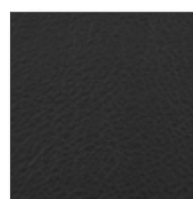

091
NERO
BLACK

I colori sono indicativi. Non è possibile garantire uniformità di tono nella tintura dei lotti di tessuto. Resta inteso che lievi differenze di colore verranno accettate al momento dell'ordine.

The colors are just indicative. Actually a steady tone of lots cannot be guaranteed. It remains understood that any slight colour difference will be accepted in case an order is placed.

CAT.O

078 PELLE RIO/FRASSINO - LEATHER RIO/ASH

La Francesea

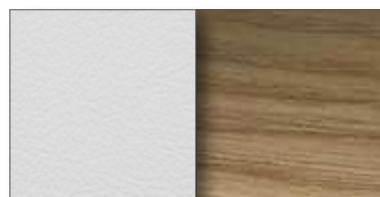

177
BIANCO/NATURALE
WHITE/NATURAL



219
ROSSO/NATURALE
RED/NATURAL

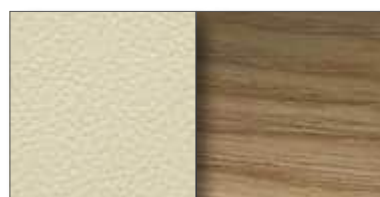

E74
LATTE/NATURALE
MILK/NATURAL

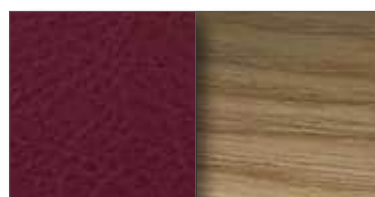

183
BORDEAUX/NATURALE
BURGUNDY/NATURAL



172
AVORIO/NATURALE
IVORY/NATURAL

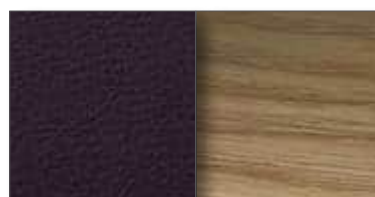

E75
PRUGNA/NATURALE
PLUM/NATURAL



221
SABBIA/NATURALE
SAND/NATURAL

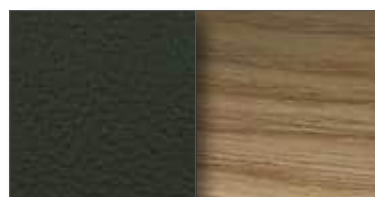

227
VERDE SCURO/NATURALE
DARK GREEN/NATURAL

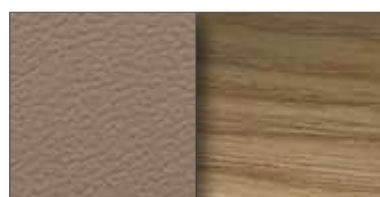

224
TORTORA/NATURALE
TAUPE/NATURAL

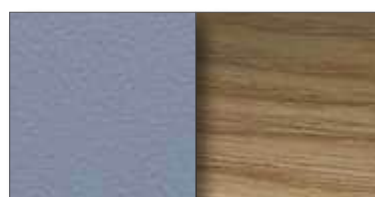

175
AZZURRO/NATURALE
LIGHT BLUE/NATURAL



190
GIALLO/NATURALE
YELLOW/NATURAL



182
BLU/NATURALE
BLUE/NATURAL

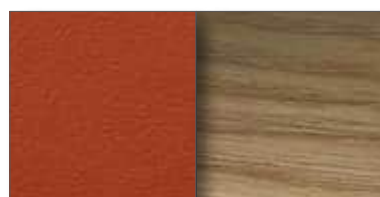

170
ARANCIO/NATURALE
ORANGE/NATURAL

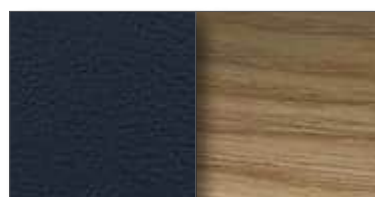

E72
BLU NOTTE/NATURALE
DARK BLUE/NATURAL

CAT.O

078 PELLE RIO/FRASSINO - LEATHER RIO/ASH

La Francesca

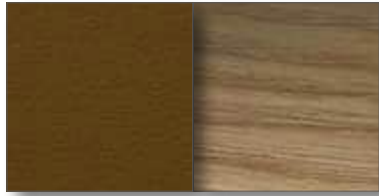

204
MARRONE CHIARO/NATURALE
LIGHT BROWN/NATURAL

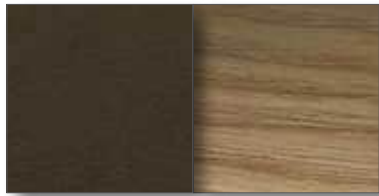

203
MARRONE SCURO/NATURALE
BROWN/NATURAL

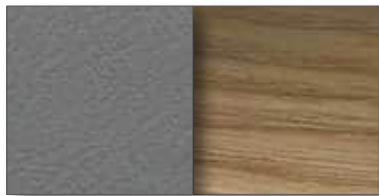

192
GRIGIO/NATURALE
GREY/NATURAL

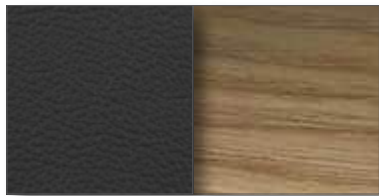

191
GRIGIO SCURO/NATURALE
DARK GREY/NATURAL

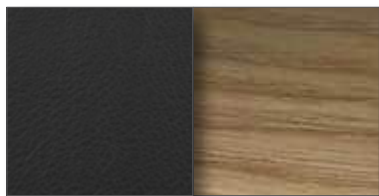

207
NERO/NATURALE
BLACK/NATURAL

CAT.O

078 PELLE RIO/FRASSINO - LEATHER RIO/ASH

La Francesea

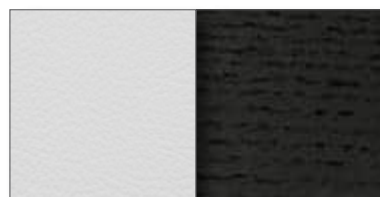

230
BIANCO/EBANIZZATO
WHITE/EBONIZED



280
ROSSO/EBANIZZATO
RED/EBONIZED



E76
LATTE/EBANIZZATO
MILK/EBONIZED

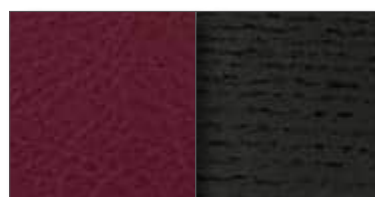

243
BORDEAUX/EBANIZZATO
BURGUNDY/EBONIZED



233
AVORIO/EBANIZZATO
IVORY/EBONIZED



E77
PRUGNA/EBANIZZATO
PLUM/EBONIZED



282
SABBIA/EBANIZZATO
SAND/EBONIZED

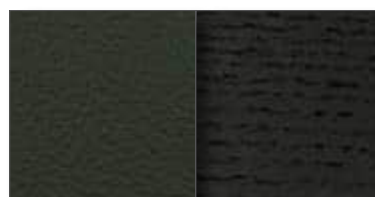

289
VERDE SCURO/EBANIZZATO
DARK GREEN/EBONIZED

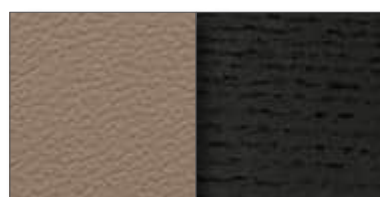

286
TORTORA/EBANIZZATO
TAUPE/EBONIZED



236
AZZURRO/EBANIZZATO
LIGHT BLUE/EBONIZED



250
GIALLO/EBANIZZATO
YELLOW/EBONIZED

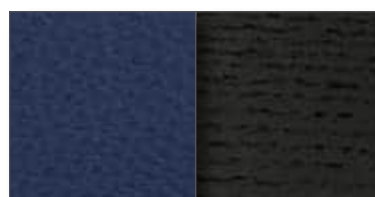

242
BLU/EBANIZZATO
BLUE/EBONIZED



231
ARANCIO/EBANIZZATO
ORANGE/EBONIZED



E64
BLU NOTTE/EBANIZZATO
DARK BLUE/EBONIZED

CAT.O

078 PELLE RIO/FRASSINO - LEATHER RIO/ASH

La Francesea

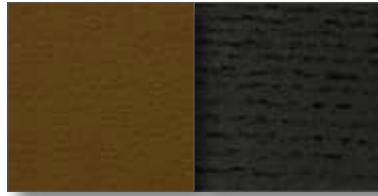

263
MARRONE CHIARO/EBANIZZATO
LIGHT BROWN/EBONIZED



265
MARRONE SCURO/EBANIZZATO
DARK BROWN/EBONIZED

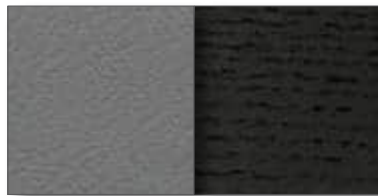

251
GRIGIO/EBANIZZATO
GREY/EBONIZED

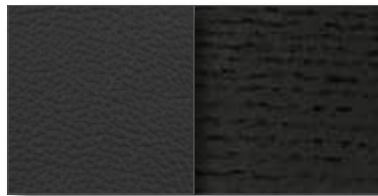

260
GRIGIO SCURO/EBANIZZATO
DARK GREY/EBONIZED

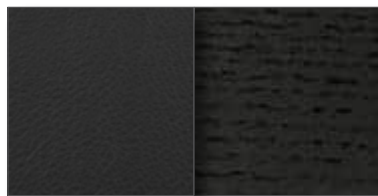

267
NERO/EBANIZZATO
BLACK/EBONIZED

CAT.O

147 PELLE RIO/ACCIAIO VERNICIATO - LEATHER RIO/PAINTED STEEL

Costes

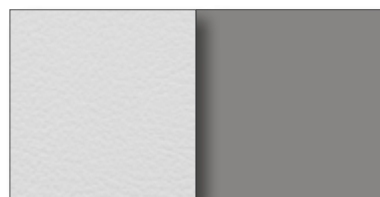

297
BIANCO/TITANIO
WHITE/TITANIUM



314
ROSSO/TITANIO
RED/TITANIUM



E78
LATTE/TITANIO
MILK/TITANIUM

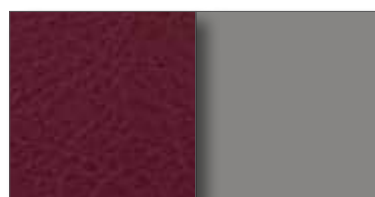

299
BORDEAUX/TITANIO
BURGUNDY/TITANIUM



294
AVORIO/TITANIO
IVORY/TITANIUM

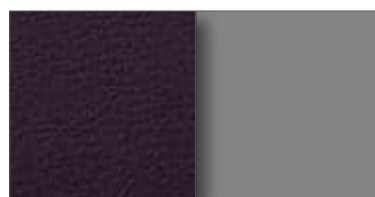

E80
PRUGNA/TITANIO
PLUM/TITANIUM

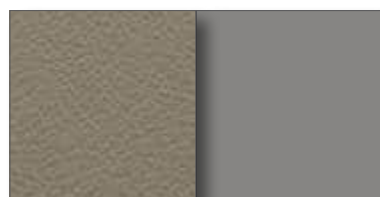

315
SABBIA/TITANIO
SAND/TITANIUM

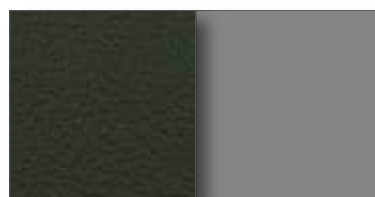

318
VERDE SCURO/TITANIO
DARK GREEN/TITANIUM

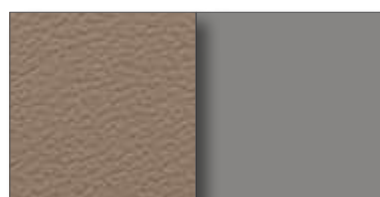

E79
TORTORA/TITANIO
TAUPE/TITANIUM

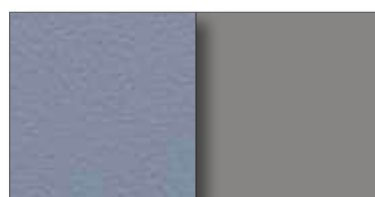

295
AZZURRO/TITANIO
LIGHT BLUE/TITANIUM

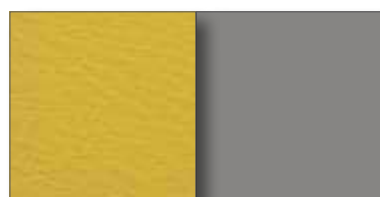

303
GIALLO/TITANIO
YELLOW/TITANIUM

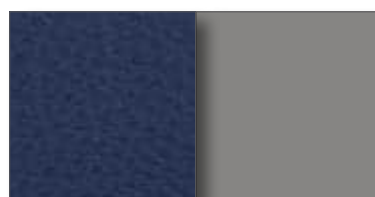

298
BLU/TITANIO
BLUE/TITANIUM

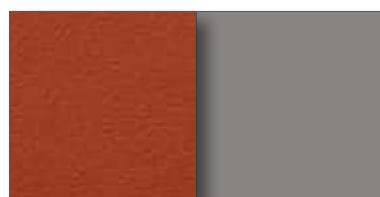

292
ARANCIO/TITANIO
ORANGE/TITANIUM

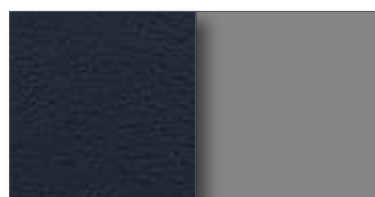

E81
BLU NOTTE/TITANIO
DARK BLUE/TITANIUM

CAT.O

147 PELLE RIO/ACCIAIO VERNICIATO - LEATHER RIO/PAINTED STEEL

Costes

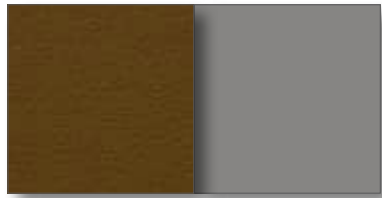

309
MARRONE CHIARO/TITANIO
LIGHT BROWN/TITANIUM

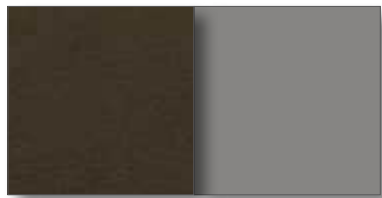

E82
MARRONE SCURO/TITANIO
DARK BROWN/TITANIUM



305
GRIGIO/TITANIO
GREY/TITANIUM

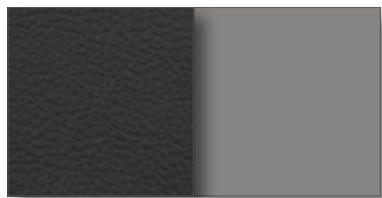

304
GRIGIO SCURO/TITANIO
DARK GREY/TITANIUM

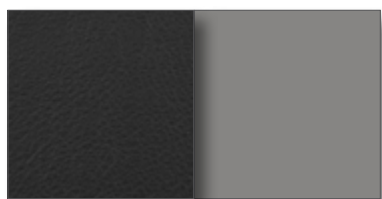

311
NERO/TITANIO
BLACK/TITANIUM

CAT.O

147 PELLE RIO/ACCIAIO VERNICIATO - LEATHER RIO/PAINTED STEEL

Elisa

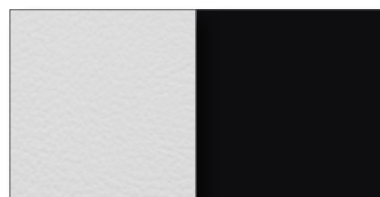

393
BIANCO/NERO MARRONE
WHITE/BLACK BROWN



424
ROSSO/NERO MARRONE
RED/BLACK BROWN

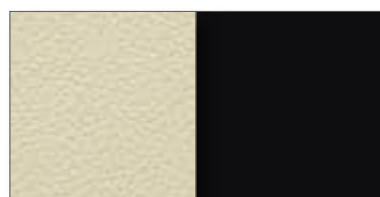

G54
LATTE/NERO MARRONE
MILK/BLACK BROWN

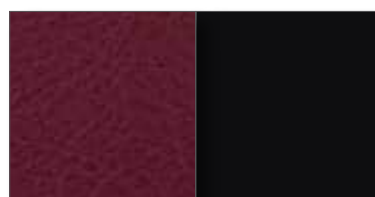

401
BORDEAUX/NERO MARRONE
BURGUNDY/BLACK BROWN



388
AVORIO/NERO MARRONE
IVORY/BLACK BROWN

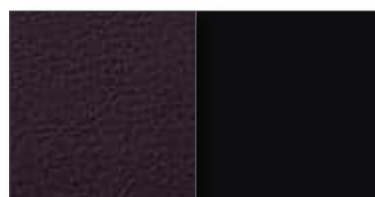

G55
PRUGNA/NERO MARRONE
PLUM/BLACK BROWN

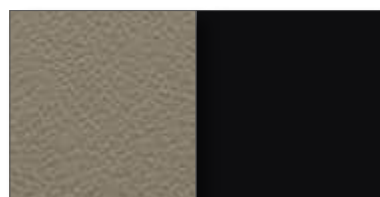

426
SABBIA/NERO MARRONE
SAND/BLACK BROWN

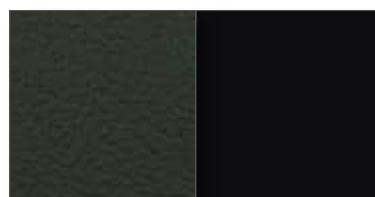

432
VERDE SCURO/NERO MARRONE
DARK GREEN/BLACK BROWN

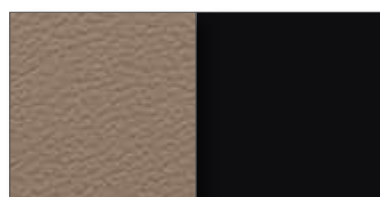

427
TORTORA/NERO MARRONE
TAUPE/BLACK BROWN

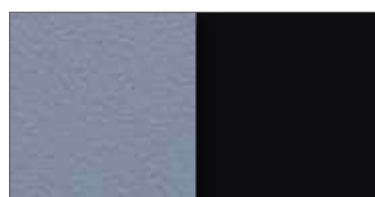

391
AZZURRO/NERO MARRONE
LIGHT BLUE/BLACK BROWN

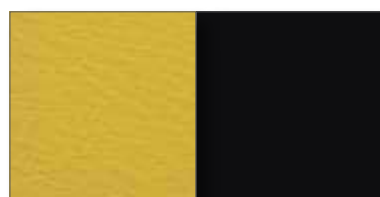

E29
GIALLO/NERO MARRONE
YELLOW/BLACK BROWN

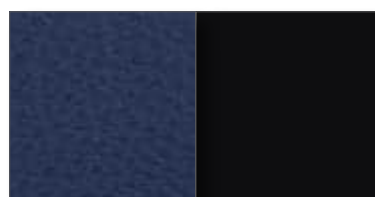

400
BLU/NERO MARRONE
BLUE/BLACK BROWN

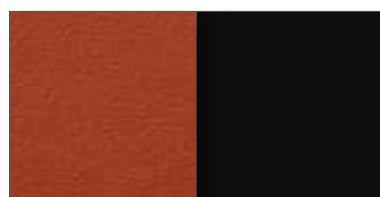

387
ARANCIO/NERO MARRONE
ORANGE/BLACK BROWN

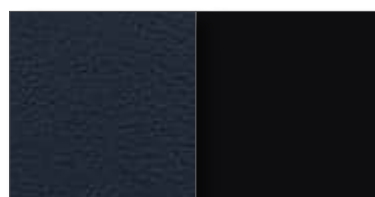

G56
BLU NOTTE/NERO MARRONE
NIGHT BLUE/BLACK BROWN

CAT.O

147 PELLE RIO/ACCIAIO VERNICIATO - LEATHER RIO/PAINTED STEEL

Elisa

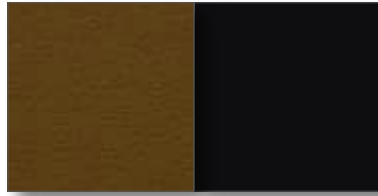

414

MARRONE CHIARO/NERO MARRONE
LIGHT BROWN/BLACK BROWN

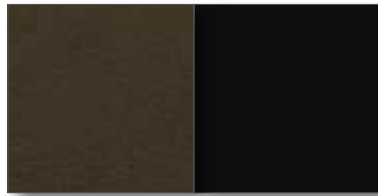

415

MARRONE SCURO/NERO MARRONE
DARK BROWN/BLACK BROWN

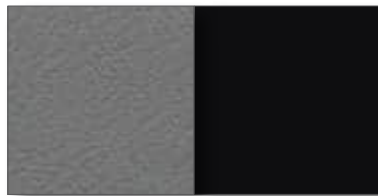

404

GRIGIO/NERO MARRONE
GREY/BLACK BROWN

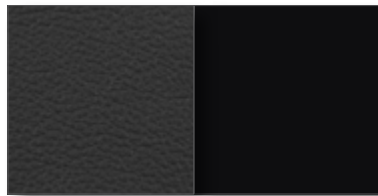

411

GRIGIO SCURO/NERO MARRONE
DARK GREY/BLACK BROWN

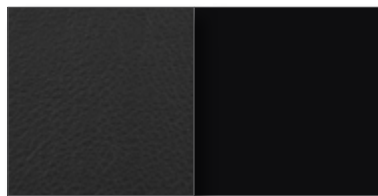

417

NERO/NERO MARRONE
BLACK/BLACK BROWN

CAT.O

147 PELLE RIO/ACCIAIO VERNICIATO - LEATHER RIO/PAINTED STEEL

Fenix

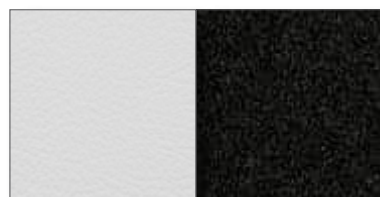

442
BIANCO/PELTRO BRONZATO
WHITE/BRONZE PEWTER



494
ROSSO/PELTRO BRONZATO
RED/BRONZE PEWTER



E83
LATTE/PELTRO BRONZATO
MILK/BRONZE PEWTER



451
BORDEAUX/PELTRO BRONZATO
BURGUNDY/BRONZE PEWTER



436
AVORIO/PELTRO BRONZATO
IVORY/BRONZE PEWTER



E84
PRUGNA/PELTRO BRONZATO
PLUM/BRONZE PEWTER



498
SABBIA/PELTRO BRONZATO
SAND/BRONZE PEWTER

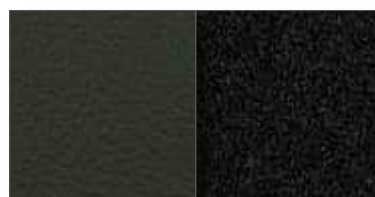

507
VERDE SCURO/PELTRO BRONZATO
DARK GREEN/BRONZE PEWTER

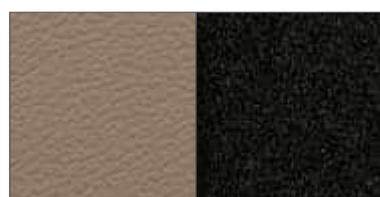

501
TORTORA/PELTRO BRONZATO
TAUPE/BRONZE PEWTER



440
AZZURRO/PELTRO BRONZATO
LIGHT BLUE/BRONZE PEWTER



460
GIALLO/PELTRO BRONZATO
YELLOW/BRONZE PEWTER



450
BLU/PELTRO BRONZATO
BLUE/BRONZE PEWTER



434
ARANCIO/PELTRO BRONZATO
ORANGE/BRONZE PEWTER



E66
BLU NOTTE/PELTRO BRONZATO
DARK BLUE/BRONZE PEWTER

CAT.O

147 PELLE RIO/ACCIAIO VERNICIATO - LEATHER RIO/PAINTED STEEL

Fenix



475

MARRONE CHIARO/PELTRO BRONZATO
LIGHT BROWN/BRONZE PEWTER



477

MARRONE SCURO/PELTRO BRONZATO
DARK BROWN/BRONZE PEWTER



461

GRIGIO/PELTRO BRONZATO
GREY/BRONZE PEWTER

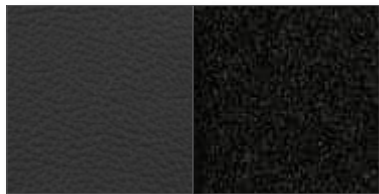

471

GRIGIO SCURO/PELTRO BRONZATO
DARK GREY/BRONZE PEWTER

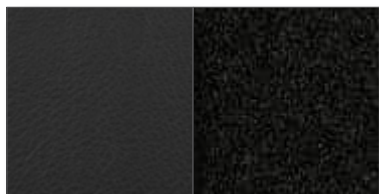

479

NERO/PELTRO BRONZATO
BLACK/BRONZE PEWTER

CAT.O

147 PELLE RIO/ACCIAIO VERNICIATO - LEATHER RIO/PAINTED STEEL

Cocky

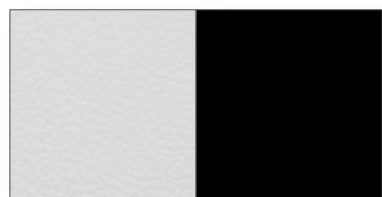

596
BIANCO/NERO
WHITE/BLACK



647
ROSSO/NERO
RED/BLACK



E91
LATTE/NERO
MILK/BLACK

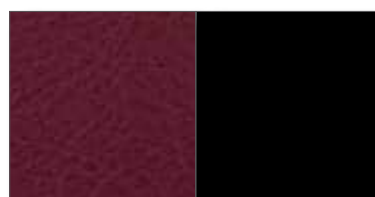

605
BORDEAUX/NERO
BURGUNDY/BLACK



590
AVORIO/NERO
IVORY/BLACK



E92
PRUGNA/NERO
PLUM/BLACK



651
SABBIA/NERO
SAND/BLACK

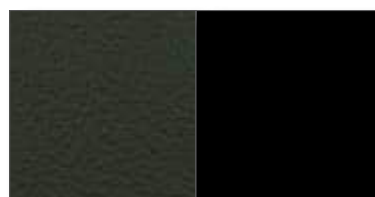

661
VERDE SCURO/NERO
DARK GREEN/BLACK

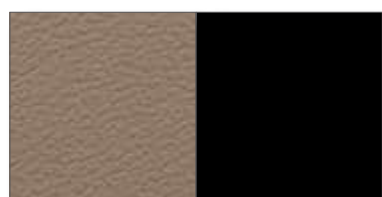

655
TORTORA/NERO
TAUPE/BLACK

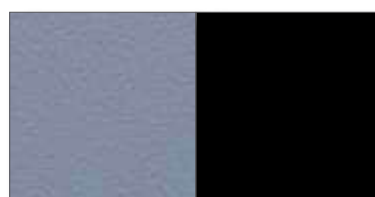

594
AZZURRO/NERO
LIGHT BLUE/BLACK



614
GIALLO/NERO
YELLOW/BLACK



604
BLU/NERO
BLUE/BLACK



588
ARANCIO/NERO
ORANGE/BLACK



E69
BLU NOTTE/NERO
DARK BLUE/BLACK

CAT.O

147 PELLE RIO/ACCIAIO VERNICIATO - LEATHER RIO/PAINTED STEEL

Cocky

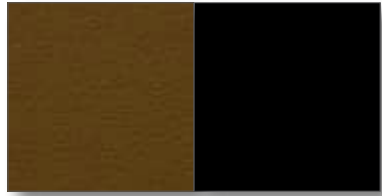

628
MARRONE CHIARO/NERO
LIGHT BROWN/BLACK



630
MARRONE SCURO/NERO
DARK BROWN/BLACK



615
GRIGIO/NERO
GREY/BLACK



625
GRIGIO SCURO/NERO
DARK GREY/BLACK

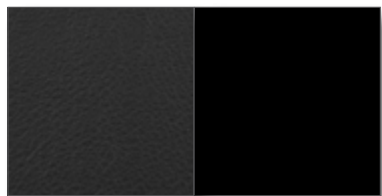

632
NERO/NERO
BLACK/BLACK

CAT.O

183 PELLE RIO/ACCIAIO CROMATO - LEATHER RIO/CHROMED STEEL

Moon, Cocky

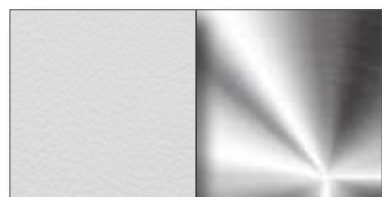

B00
BIANCO/CROMO
WHITE/CHROME



C58
ROSSO/CROMO
RED/CHROME



E85
LATTE/CROMO
MILK/CHROME



C41
BORDEAUX/CROMO
BURGUNDY/CHROME



C36
AVORIO/CROMO
IVORY/CHROME



E87
PRUGNA/CROMO
PLUM/CHROME



C59
SABBIA/CROMO
SAND/CHROME

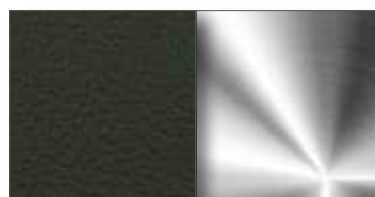

C63
VERDE SCURO/CROMO
DARK GREEN/CHROME

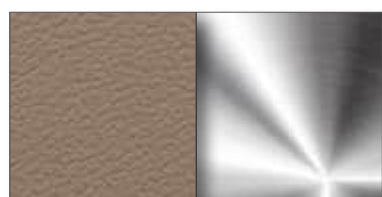

E86
TORTORA/CROMO
TAUPE/CHROME



C37
AZZURRO/CROMO
LIGHT BLUE/CHROME



C46
GIALLO/CROMO
YELLOW/CHROME



C40
BLU/CROMO
BLUE/CHROME



C34
ARANCIO/CROMO
ORANGE/CHROME



E88
BLU NOTTE/CROMO
DARK BLUE/CHROME

CAT.O

183 PELLE RIO/ACCIAIO CROMATO - *LEATHER RIO/CHROMED STEEL*

Moon, Cocky

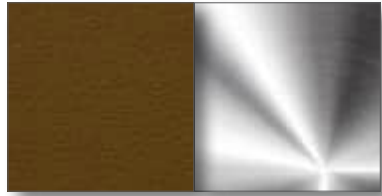

C52
MARRONE CHIARO/CROMO
LIGHT BROWN/CHROME

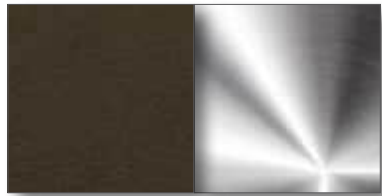

C53
MARRONE SCURO/CROMO
DARK BROWN/CHROME

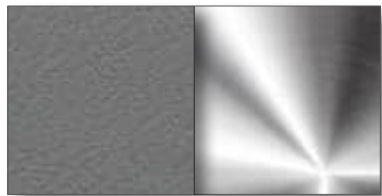

C48
GRIGIO/CROMO
GREY/CHROME



C47
GRIGIO SCURO/CROMO
DARK GREY/CHROME



B01
NERO/CROMO
BLACK/CHROME

CAT.O

212 PELLE RIO/ALLUMINIO LUCIDATO - LEATHER RIO/POLISHED ALUMINUM

Lou Speak, Cocky

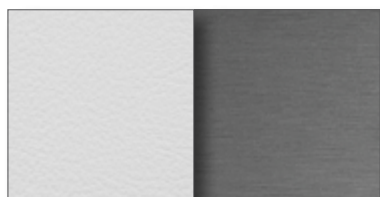

531
BIANCO/ALLUMINIO
WHITE/ALUMINUM

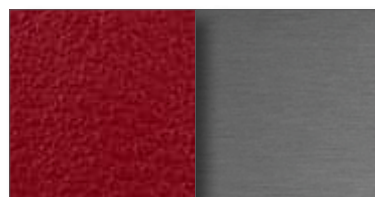

575
ROSSO/ALLUMINIO
RED/ALUMINUM

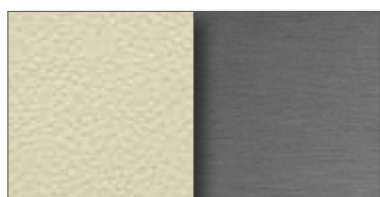

E89
LATTE/ALLUMINIO
MILK/ALUMINUM

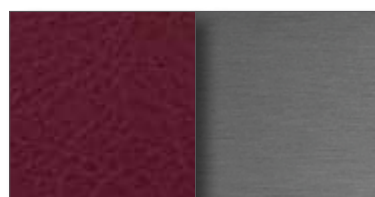

537
BORDEAUX/ALLUMINIO
BURGUNDY/ALUMINUM

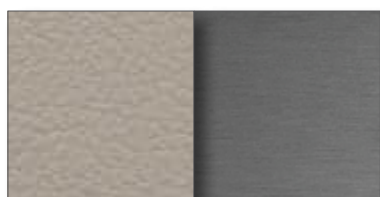

526
AVORIO/ALLUMINIO
IVORY/ALUMINUM

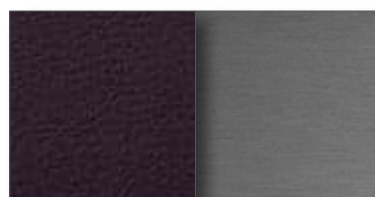

E90
PRUGNA/ALLUMINIO
PLUM/ALUMINUM

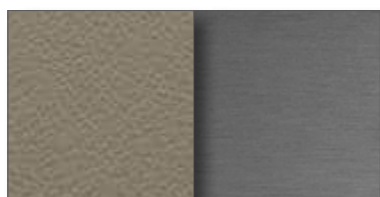

578
SABBIA/ALLUMINIO
SAND/ALUMINUM

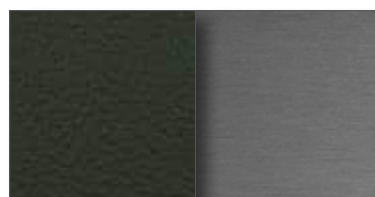

585
VERDE SCURO/ALLUMINIO
DARK GREEN/ALUMINUM

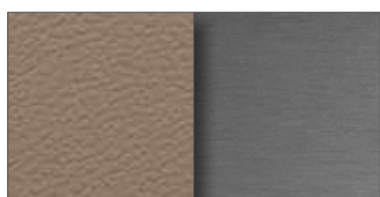

582
TORTORA/ALLUMINIO
TAUPE/ALUMINUM

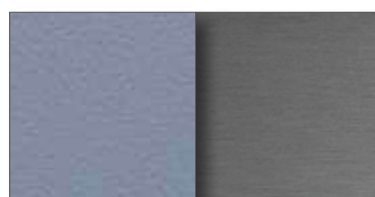

529
AZZURRO/ALLUMINIO
LIGHT BLUE/ALUMINUM

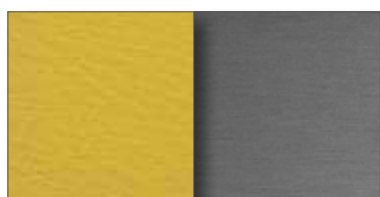

544
GIALLO/ALLUMINIO
YELLOW/ALUMINUM

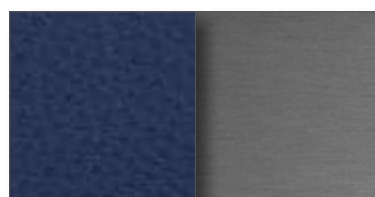

536
BLU/ALLUMINIO
BLUE/ALUMINUM



524
ARANCIO/ALLUMINIO
ORANGE/ALUMINUM

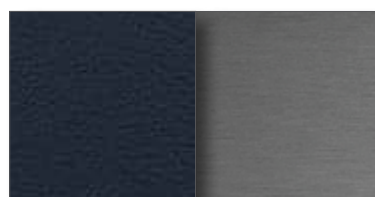

E68
BLU NOTTE/ALLUMINIO
DARK BLUE/ALUMINUM

CAT.O

212 PELLE RIO/ALLUMINIO LUCIDATO - *LEATHER RIO/POLISHED ALUMINUM*

Lou Speak, Cocky

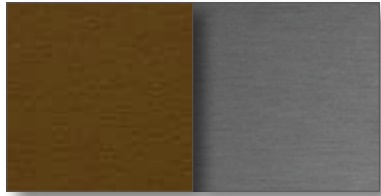

557
MARRONE CHIARO/ALLUMINIO
LIGHT BROWN/ALUMINUM



559
MARRONE SCURO/ALLUMINIO
DARK BROWN/ALUMINUM

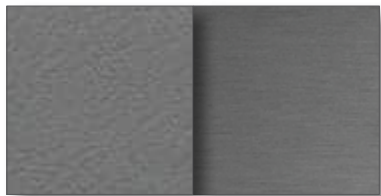

545
GRIGIO/ALLUMINIO
GREY/ALUMINUM

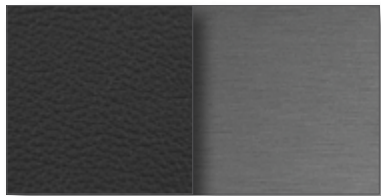

554
GRIGIO SCURO/ALLUMINIO
DARK GREY/ALUMINUM

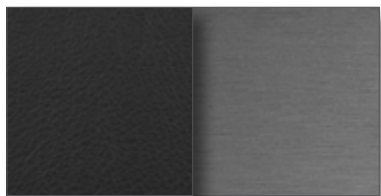

561
NERO/ALLUMINIO
BLACK/ALUMINUM

CAT.O

241 PELLE RIO/ALLUMINIO VERNICIATO - LEATHER RIO/PAINTED ALUMINUM

Lirica, Lirico, Cocky

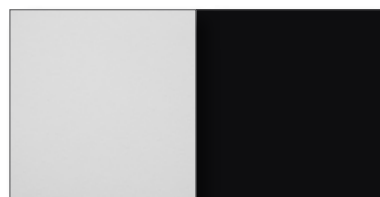

596
BIANCO/NERO
WHITE/BLACK

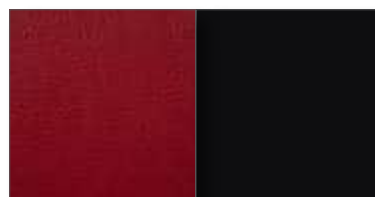

647
ROSSO/NERO
RED/BLACK

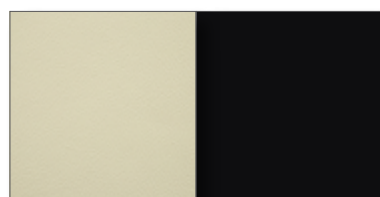

E91
LATTE/NERO
MILK/BLACK

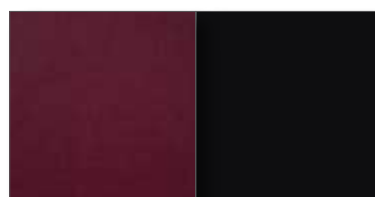

605
BORDEAUX/NERO
BURGUNDY/BLACK

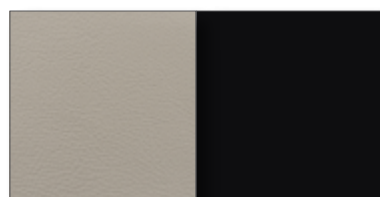

590
AVORIO/NERO
IVORY/BLACK

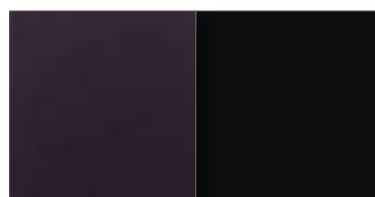

E92
PRUGNA/NERO
PLUM/BLACK

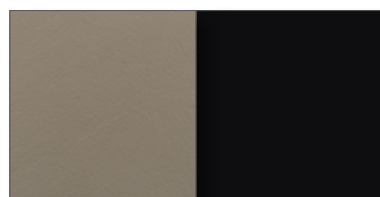

651
SABBIA/NERO
SAND/BLACK

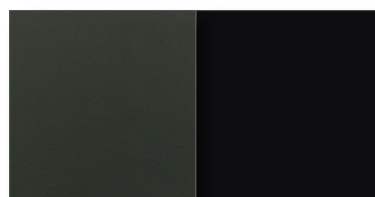

661
VERDE SCURO/NERO
DARK GREEN/BLACK

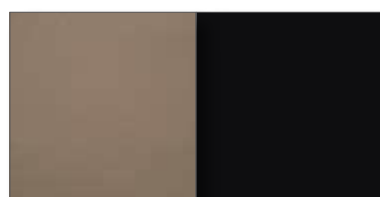

655
TORTORA/NERO
TAUPE/BLACK

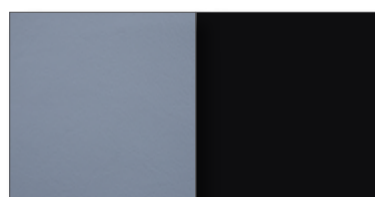

594
AZZURRO/NERO
LIGHT BLUE/BLACK

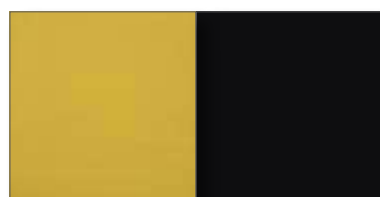

614
GIALLO/NERO
YELLOW/BLACK

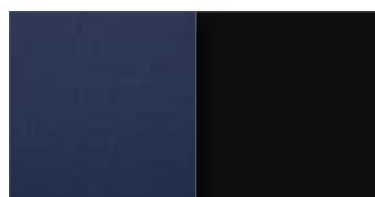

604
BLU/NERO
BLUE/BLACK

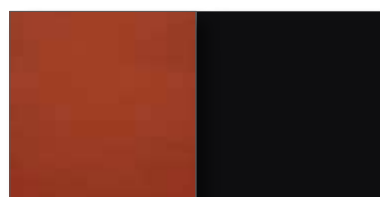

588
ARANCIO/NERO
ORANGE/BLACK

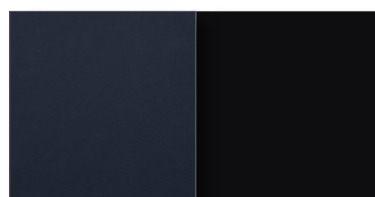

E69
BLU NOTTE/NERO
DARK BLUE/BLACK

CAT.O

241 PELLE RIO/ALLUMINIO VERNICIATO - *LEATHER RIO/PAINTED ALUMINUM*

Lirica, Lirico, Cocky

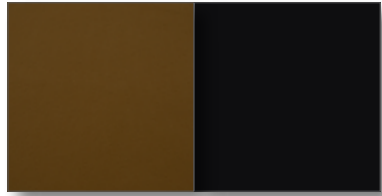

628
MARRONE CHIARO/NERO
LIGHT BROWN/BLACK

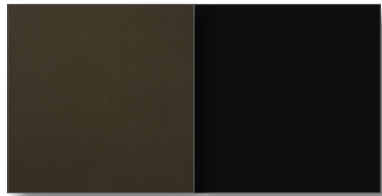

630
MARRONE SCURO/NERO
DARK BROWN/BLACK

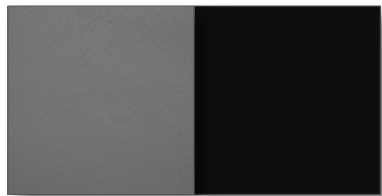

615
GRIGIO/NERO
GREY/BLACK

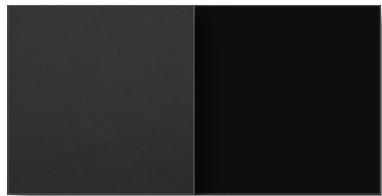

625
GRIGIO SCURO/NERO
DARK GREY/BLACK

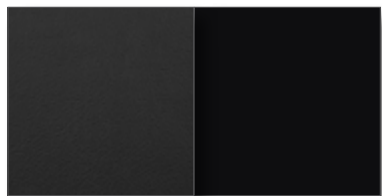

632
NERO/NERO
BLACK/BLACK

CAT.O

241 PELLE RIO/ALLUMINIO VERNICIATO - LEATHER RIO/PAINTED ALUMINUM

Lirica, Lirico

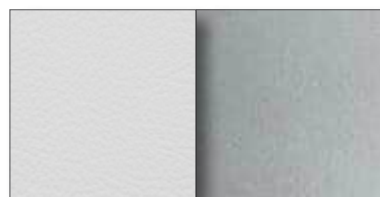

722
BIANCO/ARGENTO
WHITE/SILVER



774
ROSSO/ARGENTO
RED/SILVER



E96
LATTE/ARGENTO
MILK/SILVER



731
BORDEAUX/ARGENTO
BURGUNDY/SILVER

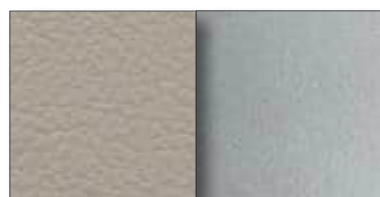

716
AVORIO/ARGENTO
IVORY/SILVER



E97
PRUGNA/ARGENTO
PLUM/SILVER



778
SABBIA/ARGENTO
SAND/SILVER



788
VERDE SCURO/ARGENTO
DARK GREEN/SILVER

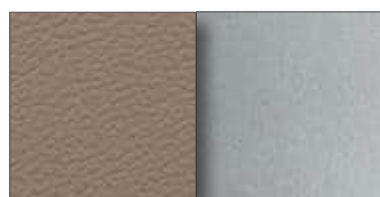

782
TORTORA/ARGENTO
TAUPE/SILVER



720
AZZURRO/ARGENTO
LIGHT BLUE/SILVER



740
GIALLO/ARGENTO
YELLOW/SILVER



730
BLU/ARGENTO
BLUE/SILVER



714
ARANCIO/ARGENTO
ORANGE/SILVER



E70
BLU NOTTE/ARGENTO
DARK BLUE/SILVER

CAT.O

241 PELLE RIO/ALLUMINIO VERNICIATO - *LEATHER RIO/PAINTED ALUMINUM*

Lirica, Lirico



755
MARRONE CHIARO/ARGENTO
LIGHT BROWN/SILVER



757
MARRONE SCURO/ARGENTO
DARK BROWN/SILVER



741
GRIGIO/ARGENTO
GREY/SILVER



751
GRIGIO SCURO/ARGENTO
DARK GREY/SILVER



759
NERO/ARGENTO
BLACK/SILVER

CAT.O

334 PELLE RIO/FAGGIO LACCATO - LEATHER RIO/LACQUERED BEECH

S.Marco, S.Marco Lounge

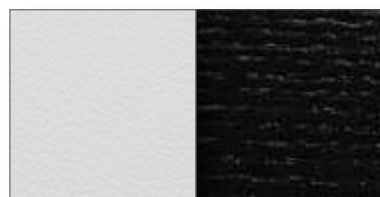

596
BIANCO/NERO
WHITE/BLACK



647
ROSSO/NERO
RED/BLACK

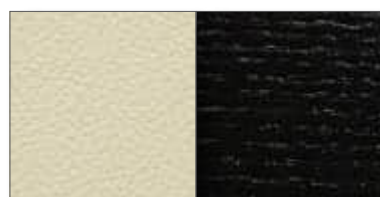

E91
LATTE/NERO
MILK/BLACK



605
BORDEAUX/NERO
BURGUNDY/BLACK



590
AVORIO/NERO
IVORY/BLACK



E92
PRUGNA/NERO
PLUM/BLACK



651
SABBIA/NERO
SAND/BLACK



661
VERDE SCURO/NERO
DARK GREEN/BLACK

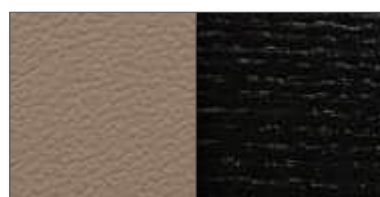

655
TORTORA/NERO
TAUPE/BLACK



594
AZZURRO/NERO
LIGHT BLUE/BLACK



614
GIALLO/NERO
YELLOW/BLACK



604
BLU/NERO
BLUE/BLACK



588
ARANCIO/NERO
ORANGE/BLACK



E69
BLU NOTTE/NERO
DARK BLUE/BLACK

CAT.O

334 PELLE RIO/FAGGIO LACCATO - *LEATHER RIO/LACQUERED BEECH*

S.Marco, S.Marco Lounge

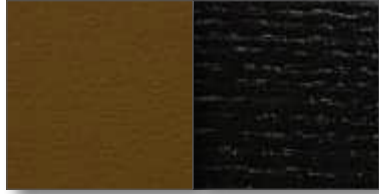

628
MARRONE CHIARO/NERO
LIGHT BROWN/BLACK



630
MARRONE SCURO/NERO
DARK BROWN/BLACK

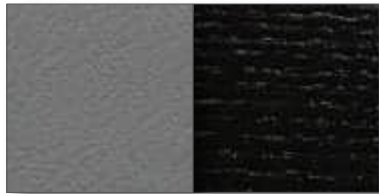

615
GRIGIO/NERO
GREY/BLACK

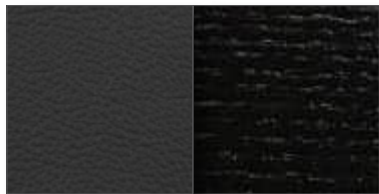

625
GRIGIO SCURO/NERO
DARK GREY/BLACK

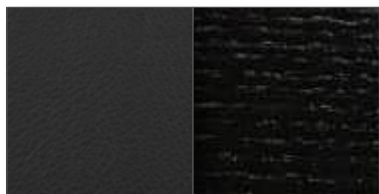

632
NERO/NERO
BLACK/BLACK

CAT.O

416 PU RIGIDO VERNICIATO/PELLE RIO/ACCIAIO CROMATO
STIFF PAINTED PU/LEATHER RIO/CHROMED STEEL

Moon

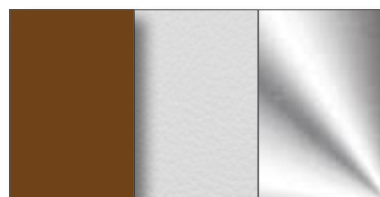

864
MATTONE/BIANCO/CROMO
RED BRICK/WHITE/CHROME

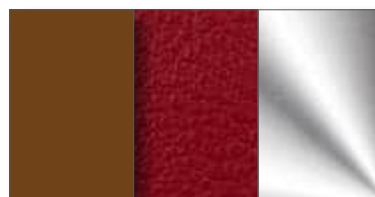

913
MATTONE/ROSSO/CROMO
RED BRICK/WHIREDETE/CHROME



F01
MATTONE/LATTE/CROMO
RED BRICK/MILK/CHROME

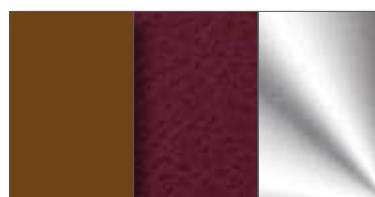

872
MATTONE/BORDEAUX/CROMO
RED BRICK/BURGUNDY/CHROME



859
MATTONE/AVORIO/CROMO
RED BRICK/IVORY/CHROME

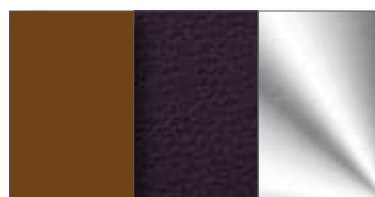

F02
MATTONE/PRUGNA/CROMO
RED BRICK/PLUM/CHROME

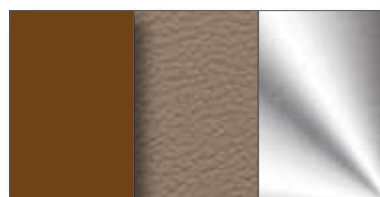

917
MATTONE/SABBIA/CROMO
RED BRICK/SAND/CHROME

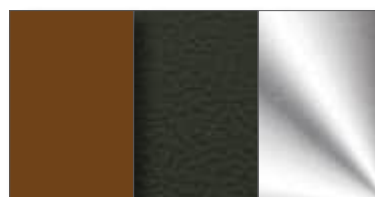

926
MATTONE/VERDE SCURO/CROMO
RED BRICK/DARK GREEN/CHROME



920
MATTONE/TORTORA/CROMO
RED BRICK/TAUPE/CHROME

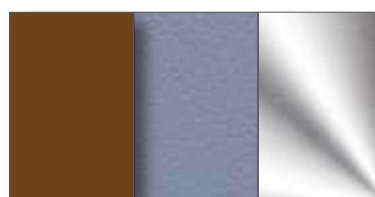

862
MATTONE/AZZURRO/CROMO
RED BRICK/LIGHT BLUE/CHROME



880
MATTONE/GIALLO/CROMO
RED BRICK/YELLOW/CHROME



871
MATTONE/BLU/CROMO
RED BRICK/BLUE/CHROME

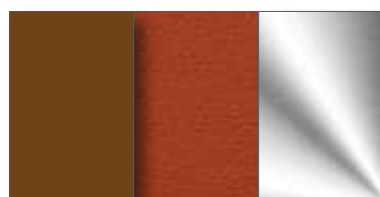

857
MATTONE/ARANCIO/CROMO
RED BRICK/ORANGE/CHROME

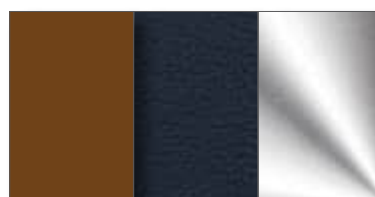

F03
MATTONE/BLU NOTTE/CROMO
RED BRICK/DARK BLUE/CHROME

CAT.O

416 PU RIGIDO VERNICIATO/PELLE RIO/ACCIAIO CROMATO
STIFF PAINTED PU/LEATHER RIO/CHROMED STEEL

Moon



895

MATTONE/MARRONE CHIARO/CROMO
RED BRICK/LIGHT BROWN/CHROME

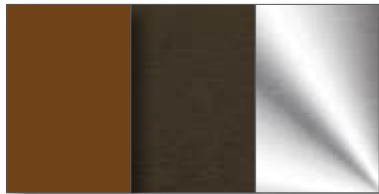

897

MATTONE/MARRONE SCURO/CROMO
RED BRICK/DARK BROWN/CHROME

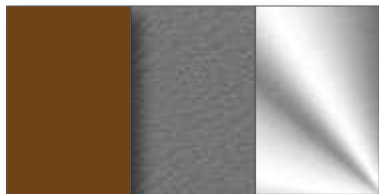

881

MATTONE/GRIGIO/CROMO
RED BRICK/GREY/CHROME

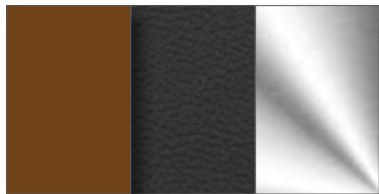

891

MATTONE/GRIGIO SCURO/CROMO
RED BRICK/DARK GREY/CHROME

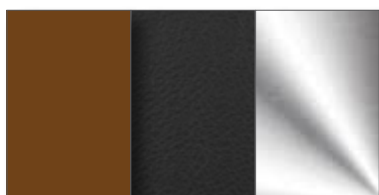

899

MATTONE/NERO/CROMO
RED BRICK/BLACK/CHROME

CAT.O

416 PU RIGIDO VERNICIATO/PELLE RIO/ACCIAIO CROMATO
STIFF PAINTED PU/LEATHER RIO/CHROMED STEEL

Moon

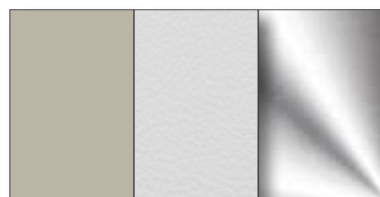

936
ECRU/BIANCO/CROMO
ECRU/WHITE/CHROME

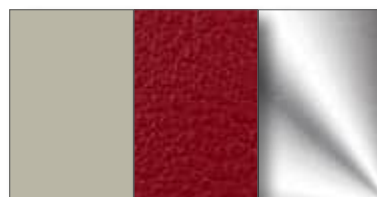

985
ECRU/ROSSO/CROMO
ECRU/RED/CHROME



F04
ECRU/LATTE/CROMO
ECRU/MILK/CHROME

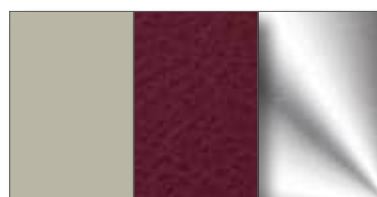

944
ECRU/BORDEAUX/CROMO
ECRU/BURGUNDY/CHROME



931
ECRU/AVORIO/CROMO
ECRU/IVORY/CHROME

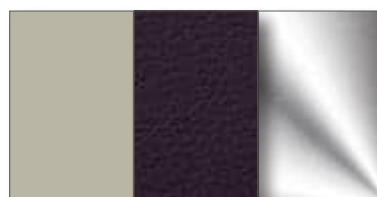

F05
ECRU/PRUGNA/CROMO
ECRU/PLUM/CHROME



989
ECRU/SABBIA/CROMO
ECRU/SAND/CHROME

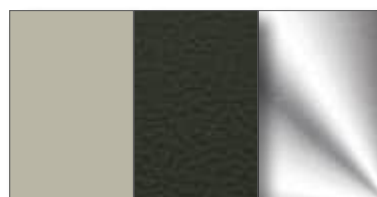

998
ECRU/VERDE SCURO/CROMO
ECRU/DARK GREEN/CHROME



992
ECRU/TORTORA/CROMO
ECRU/TAUPE/CHROME



934
ECRU/AZZURRO/CROMO
ECRU/LIGHT BLUE/CHROME

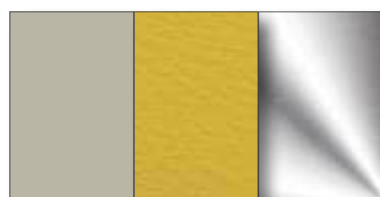

952
ECRU/GIALLO/CROMO
ECRU/YELLOW/CHROME

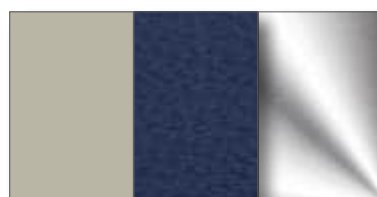

943
ECRU/BLU/CROMO
ECRU/BLUE/CHROME

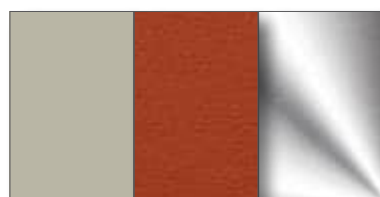

929
ECRU/ARANCIO/CROMO
ECRU/ORANGE/CHROME

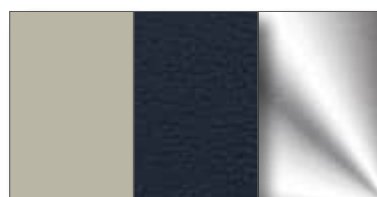

F06
ECRU/BLU NOTTE/CROMO
ECRU/DARK BLUE/CHROME

CAT.O

416 PU RIGIDO VERNICIATO/PELLE RIO/ACCIAIO CROMATO
 STIFF PAINTED PU/LEATHER RIO/CHROMED STEEL

Moon

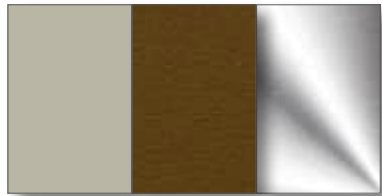

967
 ECRU/MARRONE CHIARO/CROMO
 ECRU/LIGHT BROWN/CHROME

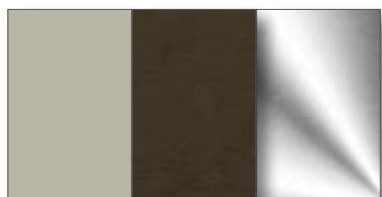

969
 ECRU/MARRONE SCURO/CROMO
 ECRU/DARK BROWN/CHROME



953
 ECRU/GRIGIO/CROMO
 ECRU/GREY/CHROME

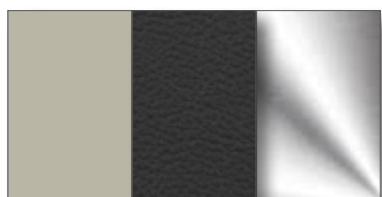

963
 ECRU/GRIGIO SCURO/CROMO
 ECRU/DARK GREY/CHROME

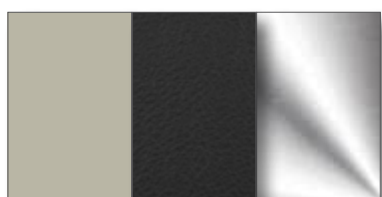

971
 ECRU/NERO/CROMO
 ECRU/BLACK/CHROME

CAT.O

416 PU RIGIDO VERNICIATO/PELLE RIO/ACCIAIO CROMATO
STIFF PAINTED PU/LEATHER RIO/CHROMED STEEL

Moon



A08
NERO/BIANCO/CROMO
BLACK/WHITE/CHROME

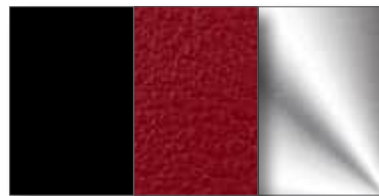

A57
NERO/ROSSO/CROMO
BLACK/RED/CHROME



F07
NERO/LATTE/CROMO
BLACK/MILK/CHROME

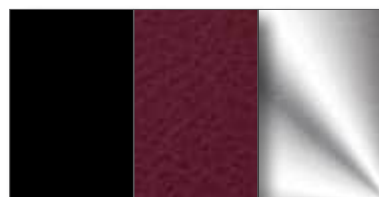

A16
NERO/BORDEAUX/CROMO
BLACK/BURGUNDY/CHROME

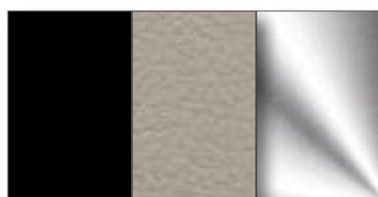

A03
NERO/AVORIO/CROMO
BLACK/IVORY/CHROME

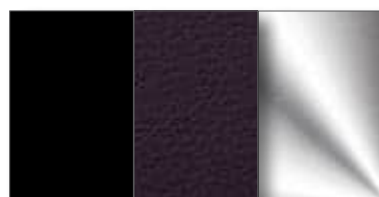

F08
NERO/PRUGNA/CROMO
BLACK/PLUM/CHROME

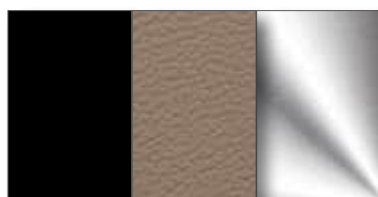

A61
NERO/SABBIA/CROMO
BLACK/SAND/CHROME

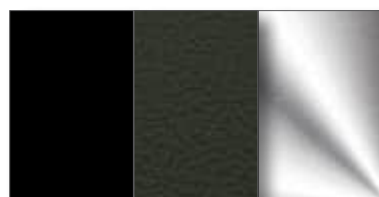

A70
NERO/VERDE SCURO/CROMO
BLACK/DARK GREEN/CHROME

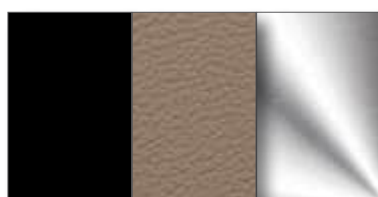

A64
NERO/TORTORA/CROMO
BLACK/TAUPE/CHROME

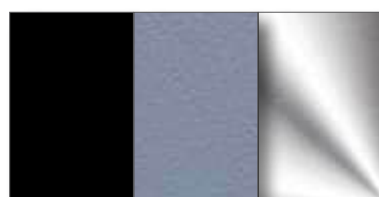

A06
NERO/AZZURRO/CROMO
BLACK/LIGHT BLUE/CHROME

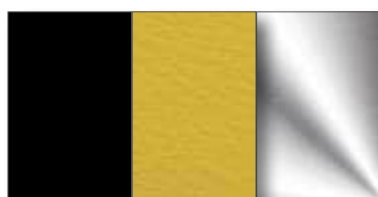

A24
NERO/GIALLO/CROMO
BLACK/YELLOW/CHROME

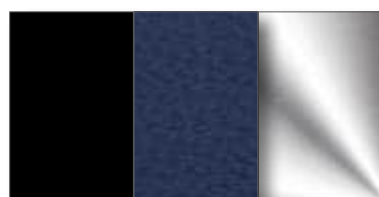

A15
NERO/BLU/CROMO
BLACK/BLUE/CHROME

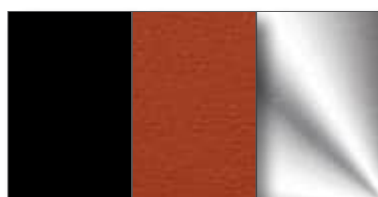

A01
NERO/ARANCIO/CROMO
BLACK/ORANGE/CHROME

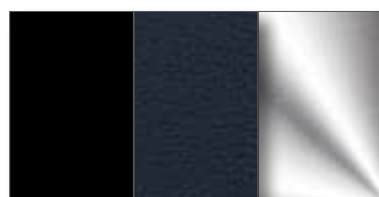

F09
NERO/BLU NOTTE/CROMO
BLACK/DARK BLUE/CHROME

CAT.O

416 PU RIGIDO VERNICIATO/PELLE RIO/ACCIAIO CROMATO
STIFF PAINTED PU/LEATHER RIO/CHROMED STEEL

Moon

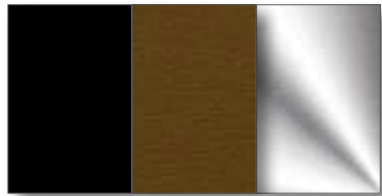

A39
 NERO/MARRONE CHIARO/CROMO
BLACK/LIGHT BROWN/CHROME

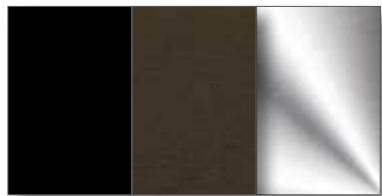

A41
 NERO/MARRONE SCURO/CROMO
BLACK/DARK BROWN/CHROME



A25
 NERO/GRIGIO/CROMO
BLACK/GREY/CHROME

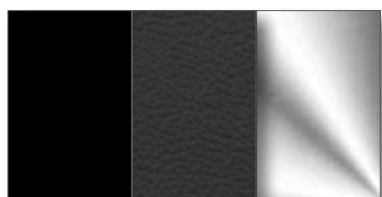

A35
 NERO/GRIGIO SCURO/CROMO
BLACK/DARK GREY/CHROME

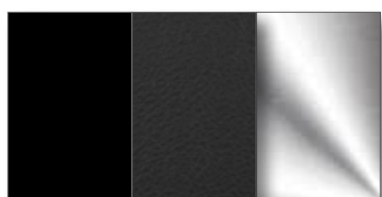

A43
 NERO/NERO/CROMO
BLACK/BLACK/CHROME

CAT.ZC

051 PELLE CHURCHILL - *LEATHER CHURCHILL*

Chrome tanning, bull hides with european origin, aniline - full grain, through dyeing aniline. Thickness: 1.0/1.2 mm; BS5852 Source 0 and Source 1

PULIRE SOLO CON PANNINO UMIDO E DETERGENTE NEUTRO/CLEAN ONLY WITH A DAMP CLOTH AND A NEUTRAL DETERGENT



003
POLVERE
DUSTY



084
CUOIO
LEATHER



081
MARRONE
BROWN



085
TESTA DI MORO
DARK BROWN

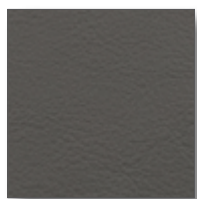

045
GRIGIO CHIARO
LIGHT GREY



057
ANTRACITE
ANTHRACITE

I colori sono indicativi. Non è possibile garantire uniformità di tono nella tintura dei lotti di tessuto. Resta inteso che lievi differenze di colore verranno accettate al momento dell'ordine.

The colors are just indicative. Actually a steady tone of lots cannot be guaranteed. It remains understood that any slight colour difference will be accepted in case an order is placed.

CAT.ZC

080 PELLE CHURCHILL/FRASSINO - LEATHER CHURCHILL/ASH

La Francesea



213
POLVERE/NATURALE
DUSTY/NATURAL



187
CUOIO/NATURALE
LEATHER/NATURAL



206
MARRONE/NATURALE
BROWN/NATURAL

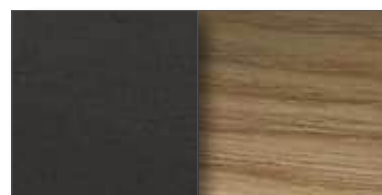

223
TESTA DI MORO/NATURALE
DARK BROWN/NATURAL

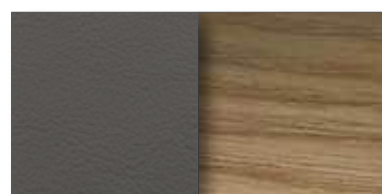

197
GRIGIO CHIARO/NATURALE
LIGHT GREY/NATURAL

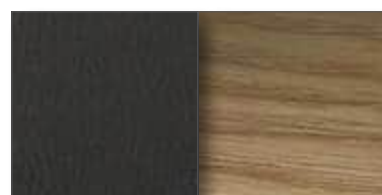

193
ANTRACITE/NATURALE
ANTHRACITE/NATURAL

La Francesea



274
POLVERE/EBANIZZATO
DUSTY/EBONIZED

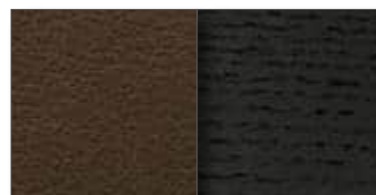

247
CUOIO/EBANIZZATO
LEATHER/EBONIZED

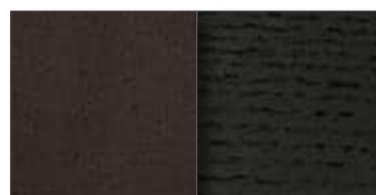

266
MARRONE/EBANIZZATO
BROWN/EBONIZED



285
TESTA DI MORO/EBANIZZATO
DARK BROWN/EBONIZED

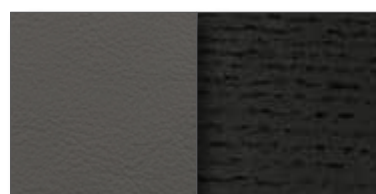

256
GRIGIO CHIARO/EBANIZZATO
LIGHT GREY/EBONIZED



252
ANTRACITE/EBANIZZATO
ANTHRACITE/EBONIZED

CAT.ZC

149 PELLE CHURCHILL/ACCIAIO VERNICIATO - LEATHER CHURCHILL/PAINTED STEEL

Costes

Fenix



313
POLVERE/TITANIO
DUSTY/TITANIUM

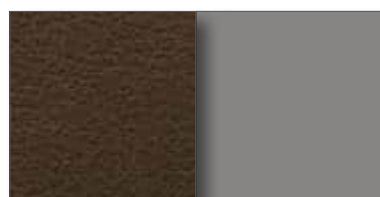

302
CUOIO/TITANIO
LEATHER/TITANIUM

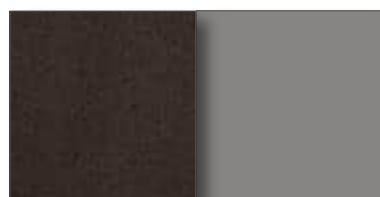

310
MARRONE/TITANIO
BROWN/TITANIUM

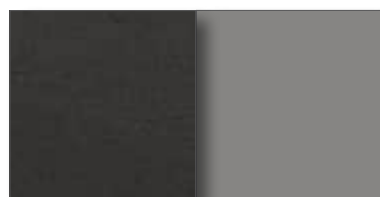

317
TESTA DI MORO/TITANIO
DARK BROWN/TITANIUM

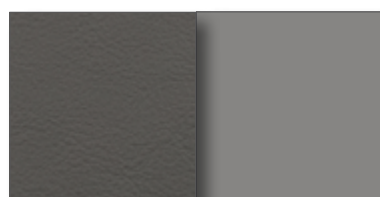

308
GRIGIO CHIARO/TITANIO
LIGHT GREY/TITANIUM

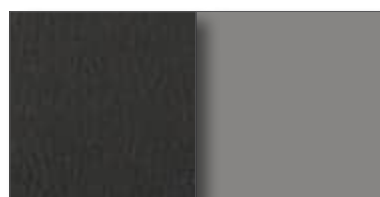

306
ANTRACITE/TITANIO
ANTHRACITE/TITANIUM



487
POLVERE/PELTRO BRONZATO
DUSTY/BRONZE PEWTER

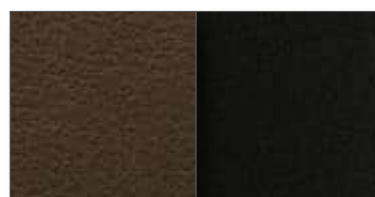

456
CUOIO/PELTRO BRONZATO
LEATHER/BRONZE PEWTER

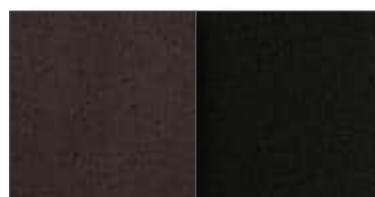

478
MARRONE/PELTRO BRONZATO
BROWN/BRONZE PEWTER

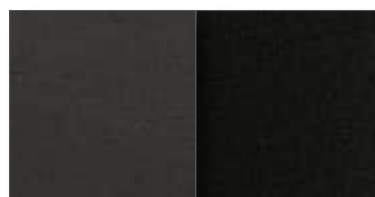

500
TESTA DI MORO/PELTRO BRONZATO
DARK BROWN/BRONZE PEWTER

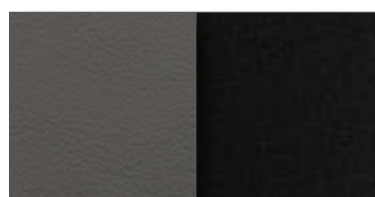

466
GRIGIO CHIARO/PELTRO BRONZATO
LIGHT GREY/BRONZE PEWTER

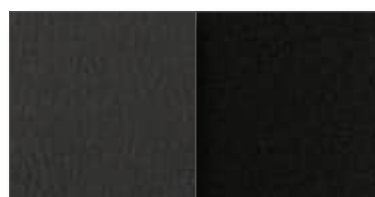

462
ANTRACITE/PELTRO BRONZATO
ANTHRACITE/BRONZE PEWTER

CAT.ZC

149 PELLE CHURCHILL/ACCIAIO VERNICIATO - LEATHER CHURCHILL/PAINTED STEEL

Wireflow



F97
POLVERE/BIANCO
DUSTY/WHITE

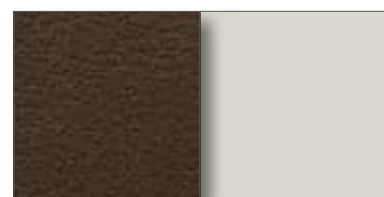

679
CUOIO/BIANCO
LEATHER/WHITE

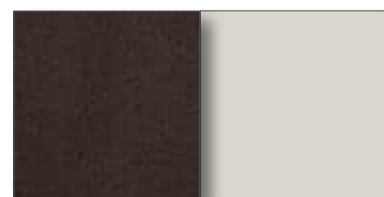

F99
MARRONE/BIANCO
BROWN/WHITE

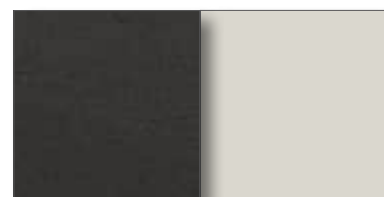

708
TESTA DI MORO/BIANCO
DARK BROWN/WHITE

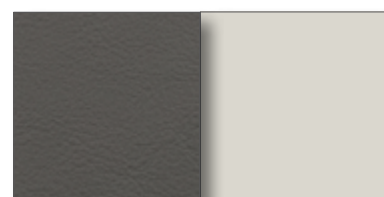

686
GRIGIO CHIARO/BIANCO
LIGHT GREY/WHITE

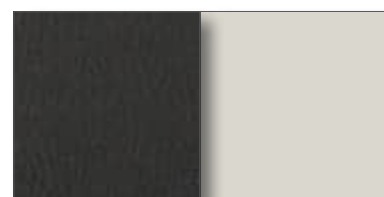

682
ANTRACITE/BIANCO
ANTHRACITE/WHITE

Wireflow, Cocky



640
POLVERE/NERO
DUSTY/BLACK

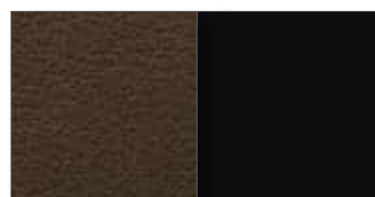

610
CUOIO/NERO
LEATHER/BLACK

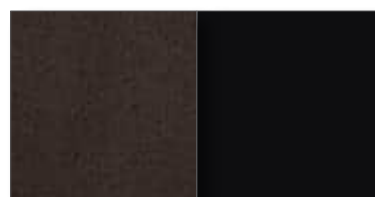

631
MARRONE/NERO
BROWN/BLACK

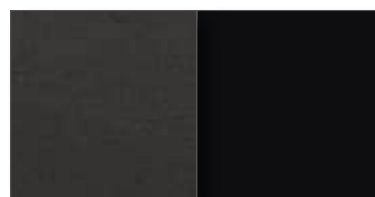

654
TESTA DI MORO/NERO
DARK BROWN/BLACK

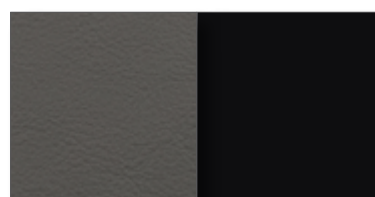

620
GRIGIO CHIARO/NERO
LIGHT GREY/BLACK

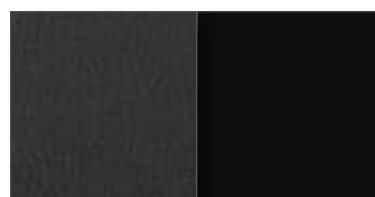

616
ANTRACITE/NERO
ANTHRACITE/BLACK

CAT.ZC

149 PELLE CHURCHILL/ACCIAIO VERNICIATO - LEATHER CHURCHILL/PAINTED STEEL

Elisa

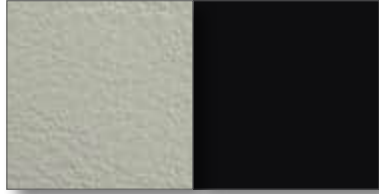

G50
POLVERE/NERO MARRONE
DUSTY/BLACK BROWN



G57
CUOIO/NERO MARRONE
LEATHER/BLACK BROWN

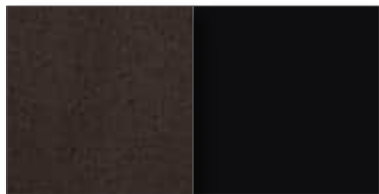

416
MARRONE/NERO MARRONE
BROWN/BLACK BROWN

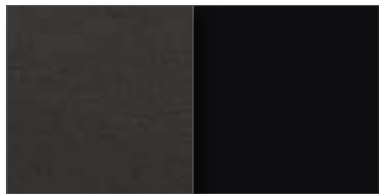

G58
TESTA DI MORO/NERO MARRONE
DARK BROWN/BLACK BROWN

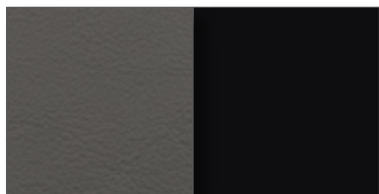

407
GRIGIO CHIARO/NERO MARRONE
LIGHT GREY/BLACK BROWN

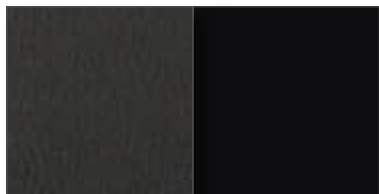

G59
ANTRACITE/NERO MARRONE
ANTHRACITE/BLACK BROWN

CAT.ZC

185 PELLE CHURCHILL/ACCIAIO CROMATO - LEATHER CHURCHILL/CHROMED STEEL

Moon, Cocky

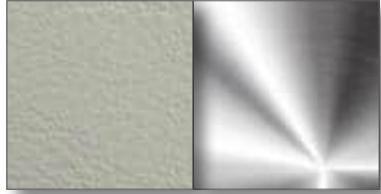

C57
POLVERE/CROMO
DUSTY/CHROME

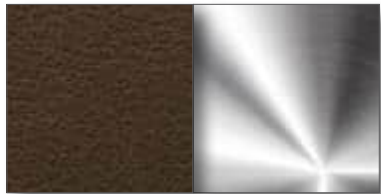

C45
CUOIO/CROMO
LEATHER/CHROME

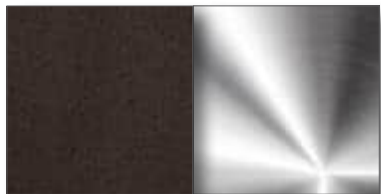

C54
MARRONE/CROMO
BROWN/CHROME

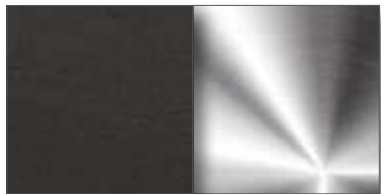

C62
TESTA DI MORO/CROMO
DARK BROWN/CHROME

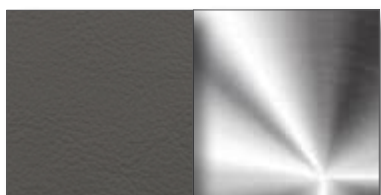

C51
GRIGIO CHIARO/CROMO
LIGHT GREY/CHROME



I14
ANTRACITE/CROMO
ANTHRACITE/CHROME

CAT.ZC

214 PELLE CHURCHILL/ALLUMINIO LUCIDATO - LEATHER CHURCHILL/POLISHED ALUMINUM

Lou Speak, Cocky



569
POLVERE/ALLUMINIO
DUSTY/ALUMINUM

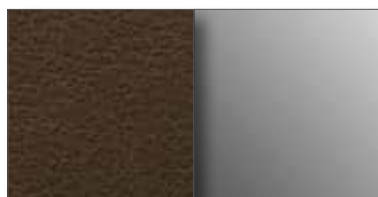

541
CUOIO/ALLUMINIO
LEATHER/ALUMINUM

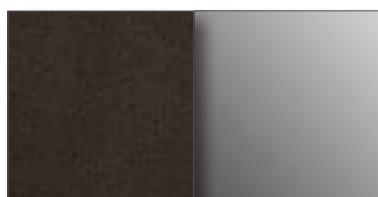

560
MARRONE/ALLUMINIO
BROWN/ALUMINUM

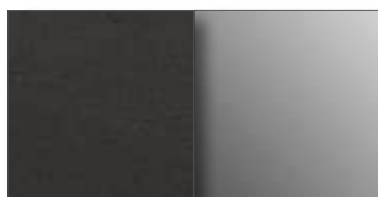

581
TESTA DI MORO/ALLUMINIO
DARK BROWN/ALUMINUM

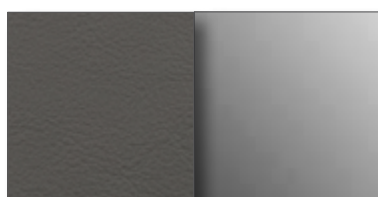

550
GRIGIO CHIARO/ALLUMINIO
LIGHT GREY/ALUMINUM

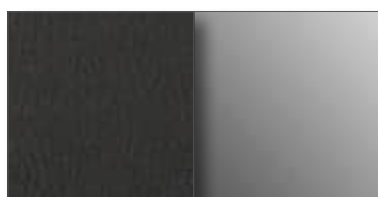

546
ANTRACITE/ALLUMINIO
ANTHRACITE/ALUMINUM

CAT.ZC

243 PELLE CHURCHILL/ALLUMINIO VERNICIATO - LEATHER CHURCHILL/PAINTED ALUMINUM

Lirica, Lirico

Lirica, Lirico

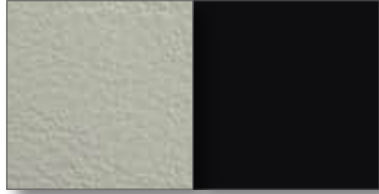

640
POLVERE/NERO
DUSTY/BLACK



767
POLVERE/ARGENTO
DUSTY/SILVER

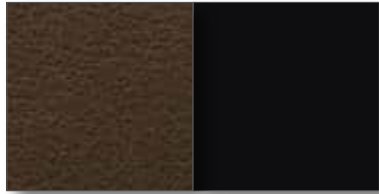

610
CUOIO/NERO
LEATHER/BLACK



736
CUOIO/ARGENTO
LEATHER/SILVER

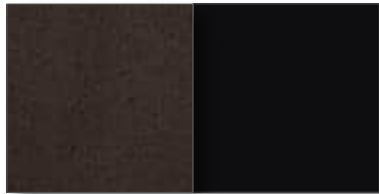

631
MARRONE/NERO
BROWN/BLACK



758
MARRONE/ARGENTO
BROWN/SILVER



654
TESTA DI MORO/NERO
DARK BROWN/BLACK



781
TESTA DI MORO/ARGENTO
DARK BROWN/SILVER

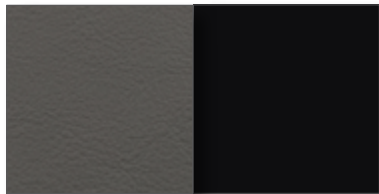

620
GRIGIO CHIARO/NERO
LIGHT GREY/BLACK

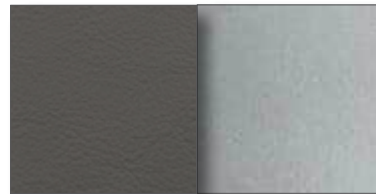

746
GRIGIO CHIARO/ARGENTO
LIGHT GREY/SILVER

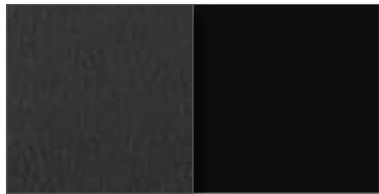

616
ANTRACITE/NERO
ANTHRACITE/BLACK



742
ANTRACITE/ARGENTO
ANTHRACITE/SILVER

CAT.ZC

336 PELLE CHURCHILL/FAGGIO LACCATO - LEATHER CHURCHILL/LACQUERED BEECH

S.Marco, S.Marco Lounge

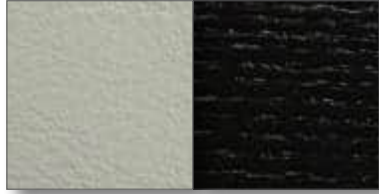

640
POLVERE/NERO
DUSTY/BLACK



610
CUOIO/NERO
LEATHER/BLACK



631
MARRONE/NERO
BROWN/BLACK



654
TESTA DI MORO/NERO
DARK BROWN/BLACK

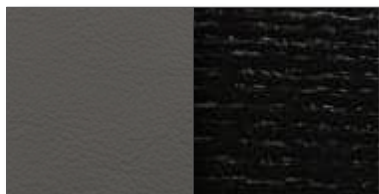

620
GRIGIO CHIARO/NERO
LIGHT GREY/BLACK

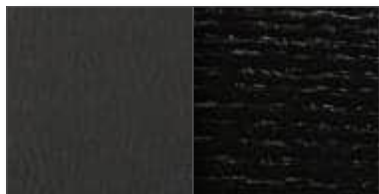

616
ANTRACITE/NERO
ANTHRACITE/BLACK

CAT.ZC

418 PU RIGIDO VERNICIATO/PELLE CHURCHILL/ACCIAIO CROMATO
STIFF PAINTED PU/LEATHER CHURCHILL/CHROMED STEEL

Moon



906
MATTONE/POLVERE/CROMO
RED BRICK/DUSTY/CHROME



978
ECRU'/POLVERE/CROMO
ECRU'/DUSTY/CHROME

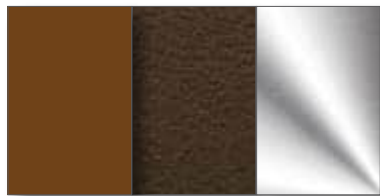

876
MATTONE/CUOIO/CROMO
RED BRICK/LEATHER/CHROME

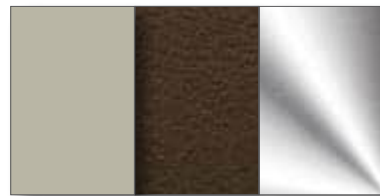

948
ECRU'/CUOIO/CROMO
ECRU'/LEATHER/CHROME



898
MATTONE/MARRONE/CROMO
RED BRICK/BROWN/CHROME

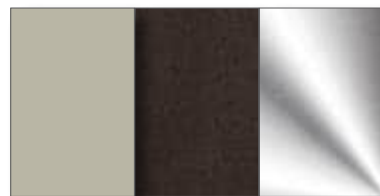

970
ECRU'/MARRONE/CROMO
ECRU'/BROWN/CHROME

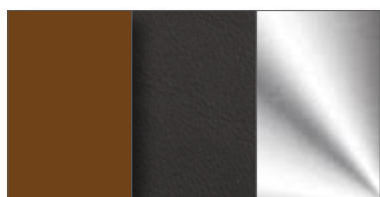

919
MATTONE/TESTA DI MORO/CROMO
RED BRICK/DARK BROWN/CHROME

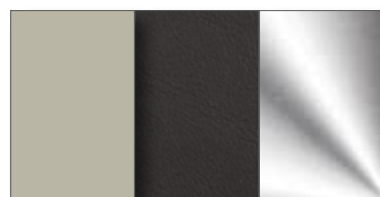

991
ECRU'/TESTA DI MORO/CROMO
ECRU'/DARK BROWN/CHROME

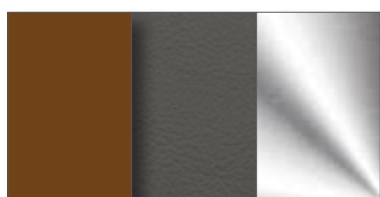

886
MATTONE/GRIGIO CHIARO/CROMO
RED BRICK/LIGHT GREY/CHROME

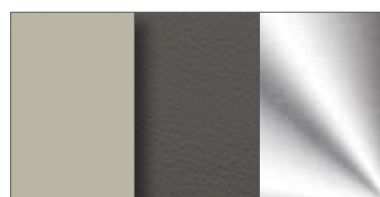

958
ECRU'/GRIGIO CHIARO/CROMO
ECRU'/LIGHT GREY/CHROME

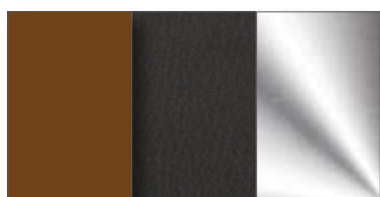

882
MATTONE/ANTRACITE/CROMO
RED BRICK/ANTHRACITE/CHROME

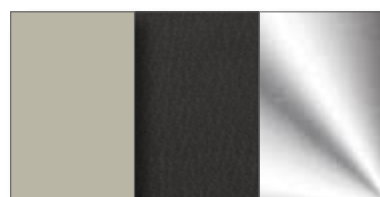

954
ECRU'/ANTRACITE/CROMO
ECRU'/ANTHRACITE/CHROME

CAT.ZC

418 PU RIGIDO VERNICIATO/PELLE CHURCHILL/ACCIAIO CROMATO
STIFF PAINTED PU/LEATHER CHURCHILL/CHROMED STEEL

Moon



A50
NERO/POLVERE/CROMO
BLACK/DUSTY/CHROME

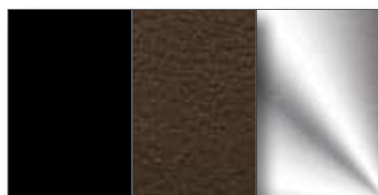

A20
NERO/CUOIO/CROMO
BLACK/LEATHER/CHROME

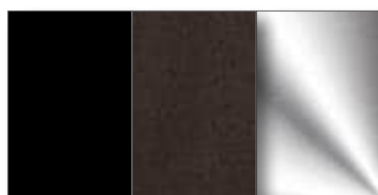

A42
NERO/MARRONE/CROMO
BLACK/BROWN/CHROME

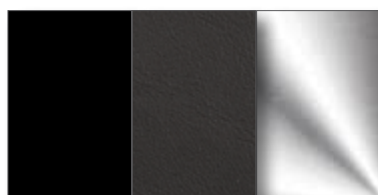

A63
NERO/TESTA DI MORO/CROMO
BLACK/DARK BROWN/CHROME

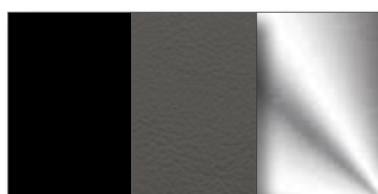

A30
NERO/GRIGIO CHIARO/CROMO
BLACK/LIGHT GREY/CHROME

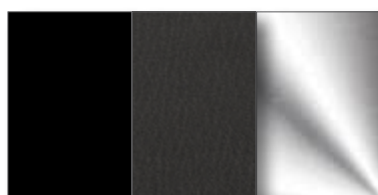

A26
NERO/ANTRACITE/CROMO
BLACK/ANTHRACITE/CHROME

CAT.ZME

052 PELLE AMUR - LEATHER AMUR

Through dyed, bovine of European origin, with a distressed vintage effect, this high quality article is obtained starting with nubuck leather, which is slightly levelled with aniline and hand rubbed to give an aged effect. Thickness: 0.9/1.1 mm; BS5852

PULIRE SOLO CON PANNINO UMIDO E DETERGENTE NEUTRO/CLEAN ONLY WITH A DAMP CLOTH AND A NEUTRAL DETERGENT



011
SABBIA
SAND

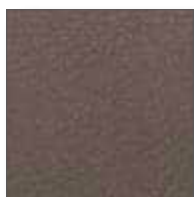

016
TORTORA
TAUPE



024
ROSA
PINK



090
AVANA
HAVANA



083
MARRONE SCURO
DARK BROWN



045
GRIGIO CHIARO
LIGHT GREY



057
ANTRACITE
ANTHRACITE

I colori sono indicativi. Non è possibile garantire uniformità di tono nella tintura dei lotti di tessuto. Resta inteso che lievi differenze di colore verranno accettate al momento dell'ordine.

The colors are just indicative. Actually a steady tone of lots cannot be guaranteed. It remains understood that any slight colour difference will be accepted in case an order is placed.

CAT.ZME

081 PELLE AMUR/FRASSINO - LEATHER AMUR/ASH

La Francesca



221
SABBIA/NATURALE
SAND/NATURAL



224
TORTORA/NATURALE
TAUPE/NATURAL



216
ROSA/NATURALE
PINK/NATURAL

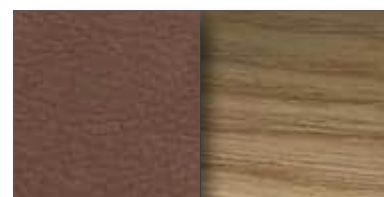

171
AVANA/NATURALE
HAVANA/NATURAL

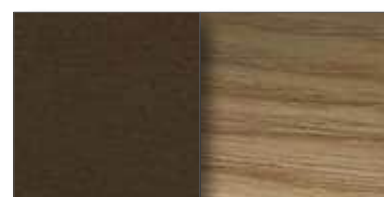

203
MARRONE SCURO/NATURALE
DARK BROWN/NATURAL



297
GRIGIO CHIARO/NATURALE
LIGHT GREY/NATURAL

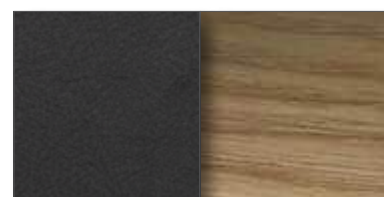

193
ANTRACITE/NATURALE
ANTHRACITE/NATURAL

La Francesca



282
SABBIA/EBANIZZATO
SAND/EBONIZED



286
TORTORA/EBANIZZATO
TAUPE/EBONIZED



277
ROSA/EBANIZZATO
PINK/EBONIZED



232
AVANA/EBANIZZATO
HAVANA/EBONIZED



265
MARRONE SCURO/EBANIZZATO
DARK BROWN/EBONIZED



256
GRIGIO CHIARO/EBANIZZATO
LIGHT GREY/EBONIZED

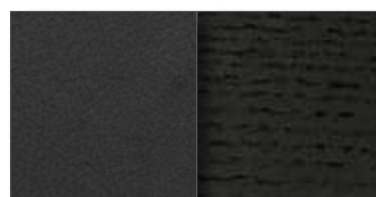

252
ANTRACITE/EBANIZZATO
ANTHRACITE/EBONIZED

CAT.ZME

150 PELLE AMUR/ACCIAIO VERNICIATO - LEATHER AMUR/PAINTED STEEL

Fenix

Wireflow



498
SABBIA/PELTRO BRONZATO
SAND/BRONZE PEWTER



501
TORTORA/PELTRO BRONZATO
TAUPE/BRONZE PEWTER



490
ROSA/PELTRO BRONZATO
PINK/BRONZE PEWTER



435
AVANA/PELTRO BRONZATO
HAVANA/BRONZE PEWTER



477
MARRONE SCURO/PELTRO BRONZATO
DARK BROWN/BRONZE PEWTER



466
GRIGIO CHIARO/PELTRO BRONZATO
LIGHT GREY/BRONZE PEWTER

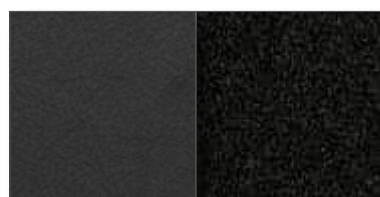

462
ANTRACITE/PELTRO BRONZATO
ANTHRACITE/BRONZE PEWTER

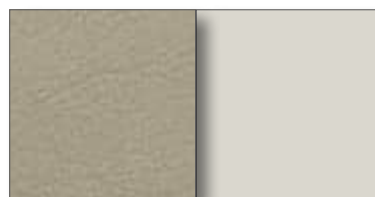

705
SABBIA/BIANCO
SAND/WHITE

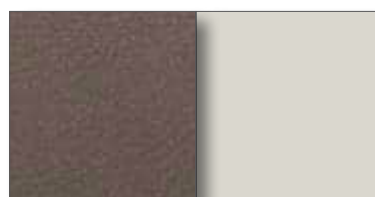

G11
TORTORA/BIANCO
TAUPE/WHITE

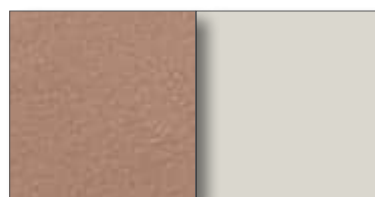

701
ROSA/BIANCO
PINK/WHITE

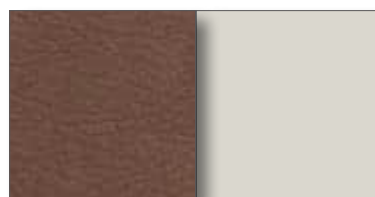

665
AVANA/BIANCO
HAVANA/WHITE

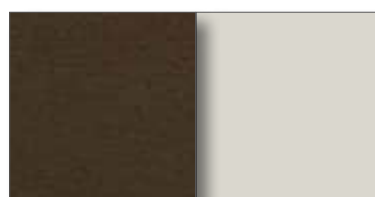

692
MARRONE SCURO/BIANCO
DARK BROWN/WHITE

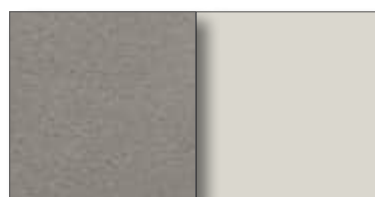

686
GRIGIO CHIARO/BIANCO
LIGHT GREY/WHITE

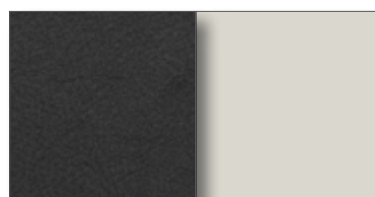

682
ANTRACITE/BIANCO
ANTHRACITE/WHITE

CAT.ZME

150 PELLE AMUR/ACCIAIO VERNICIATO - LEATHER AMUR/PAINTED STEEL

Wireflow, Cocky

Elisa

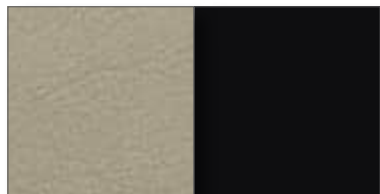

651
SABBIA/NERO
SAND/BLACK

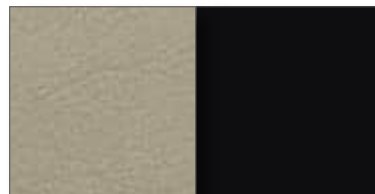

426
SABBIA/NERO MARRONE
SAND/BLACK BROWN

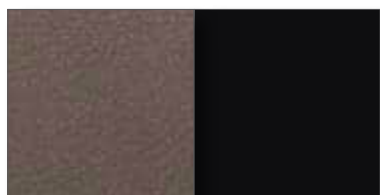

655
TORTORA/NERO
TAUPE/BLACK

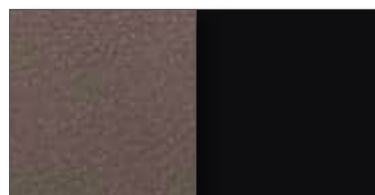

427
TORTORA/NERO MARRONE
TAUPE/BLACK BROWN



643
ROSA/NERO
PINK/BLACK

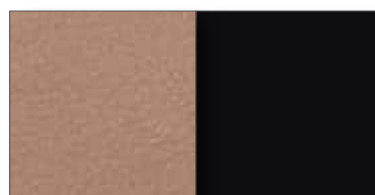

422
ROSA/NERO MARRONE
PINK/BLACK BROWN

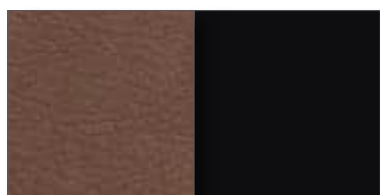

589
AVANA/NERO
HAVANA/BLACK

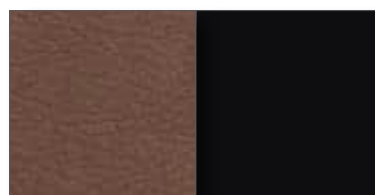

G53
AVANA/NERO MARRONE
HAVANA/BLACK BROWN

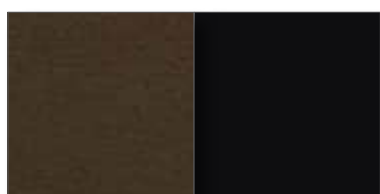

630
MARRONE SCURO/NERO
DARK BROWN/BLACK

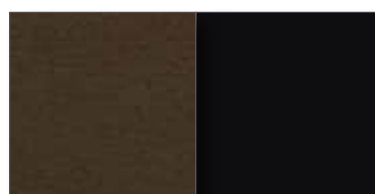

415
MARRONE SCURO/NERO MARRONE
DARK BROWN/BLACK BROWN

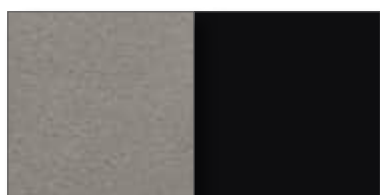

620
GRIGIO CHIARO/NERO
LIGHT GREY/BLACK

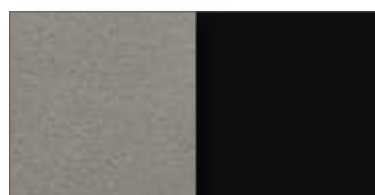

407
GRIGIO CHIARO/NERO MARRONE
LIGHT GREY/BLACK BROWN

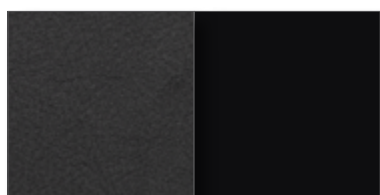

616
ANTRACITE/NERO
ANTHRACITE/BLACK

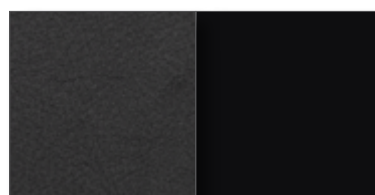

G59
ANTRACITE/NERO MARRONE
ANTHRACITE/BLACK BROWN

CAT.ZME

617 PELLE AMUR/ACCIAIO CROMATO - LEATHER AMUR/CHROMED STEEL

Cocky

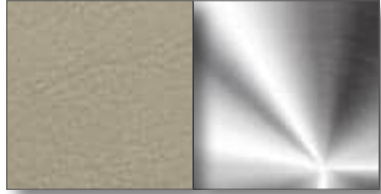

C59
SABBIA/CROMO
SAND/CHROME

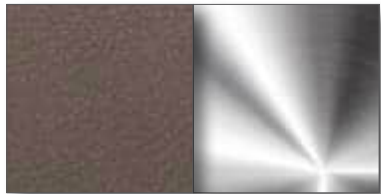

E86
TORTORA/CROMO
TAUPE/CHROME

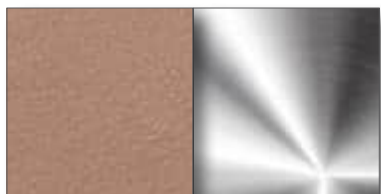

H27
ROSA/CROMO
PINK/CHROME



C35
AVANA/CROMO
HAVANA/CHROME



C53
MARRONE SCURO/CROMO
DARK BROWN/CHROME

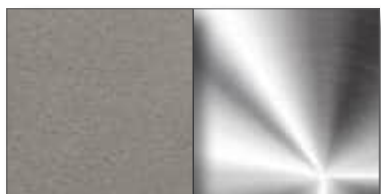

C52
GRIGIO CHIARO/CROMO
LIGHT GREY/CHROME

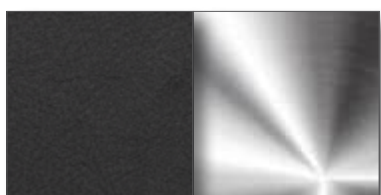

I14
ANTRACITE/CROMO
ANTHRACITE/CHROME

CAT.ZME

215 PELLE AMUR/ALLUMINIO LUCIDATO - LEATHER AMUR/POLISHED ALUMINUM

Lou Speak, Cocky

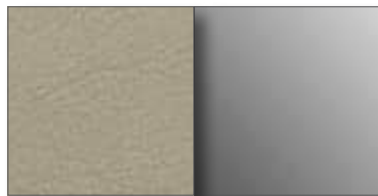

578
SABBIA/ALLUMINIO
SAND/ALUMINUM

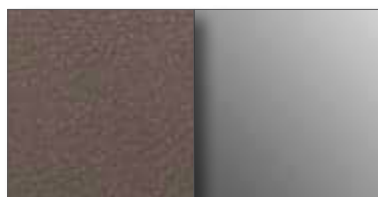

582
TORTORA/ALLUMINIO
TAUPE/ALUMINUM

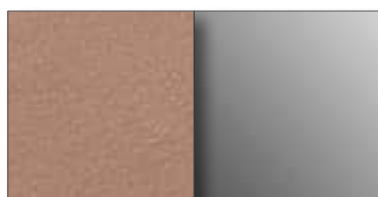

572
ROSA/ALLUMINIO
PINK/ALUMINUM

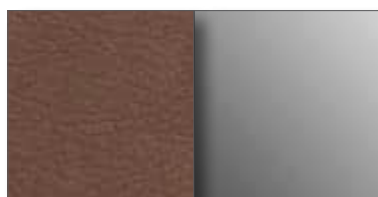

525
AVANA/ALLUMINIO
HAVANA/ALUMINUM

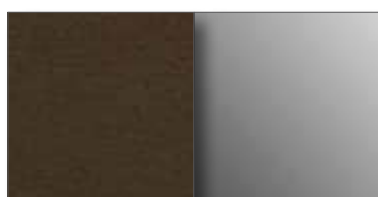

559
MARRONE SCURO/ALLUMINIO
DARK BROWN/ALUMINUM

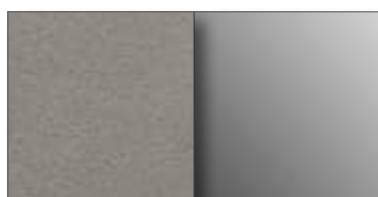

550
GRIGIO CHIARO/ALLUMINIO
LIGHT GREY/ALUMINUM

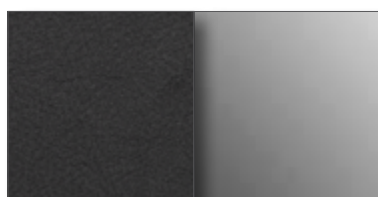

546
ANTRACITE/ALLUMINIO
ANTHRACITE GREY/ALUMINUM

CAT.ZME

244 PELLE AMUR/ALLUMINIO VERNICIATO - LEATHER AMUR/PAINTED ALUMINUM

Lirica, Lirico

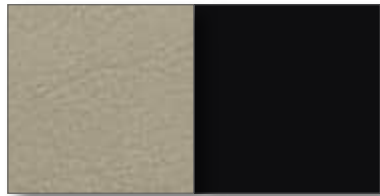

651
SABBIA/NERO
SAND/BLACK

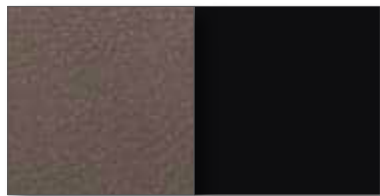

655
TORTORA/NERO
TAUPE/BLACK

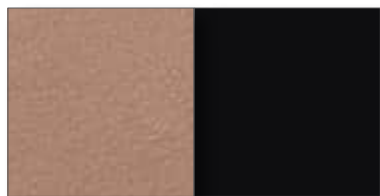

643
ROSA/NERO
PINK/BLACK

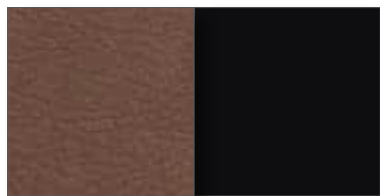

589
AVANA/NERO
HAVANA/BLACK

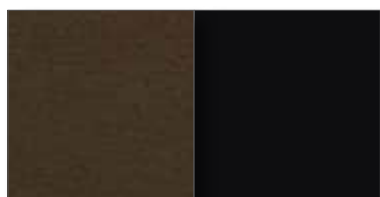

630
MARRONE SCURO/NERO
DARK BROWN/BLACK

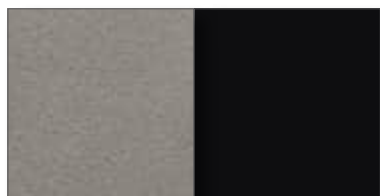

620
GRIGIO CHIARO/NERO
LIGHT GREY/BLACK

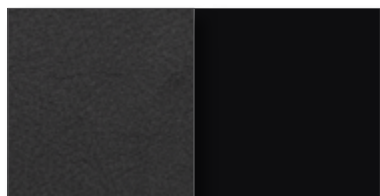

616
ANTRACITE/NERO
ANTHRACITE/BLACK

CAT.ZME

244 PELLE AMUR/ALLUMINIO VERNICIATO - LEATHER AMUR/PAINTED ALUMINUM

Lirica, Lirico



778
SABBIA/ARGENTO
SAND/SILVER



782
TORTORA/ARGENTO
TAUPE/SILVER



770
ROSA/ARGENTO
PINK/SILVER



715
AVANA/ARGENTO
HAVANA/SILVER

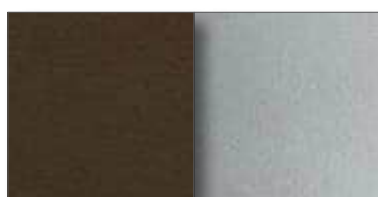

757
MARRONE SCURO/ARGENTO
DARK BROWN/SILVER



746
GRIGIO CHIARO/ARGENTO
LIGHT GREY/SILVER

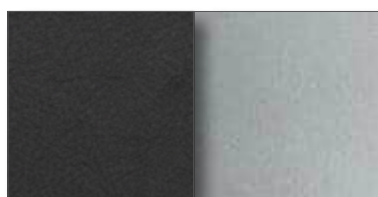

742
ANTRACITE/ARGENTO
ANTHRACITE/SILVER

CAT.ZME

337 PELLE AMUR/FAGGIO LACCATO - *LEATHER AMUR/LACQUERED BEECH*

S.Marco, S.Marco Lounge



651
SABBIA/NERO
SAND/BLACK

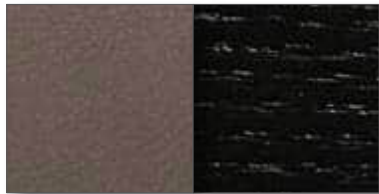

655
TORTORA/NERO
TAUPE/BLACK

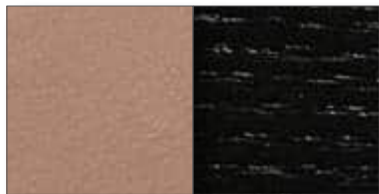

643
ROSA/NERO
PINK/BLACK

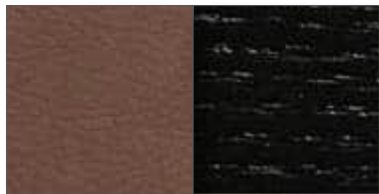

589
AVANA/NERO
HAVANA/BLACK

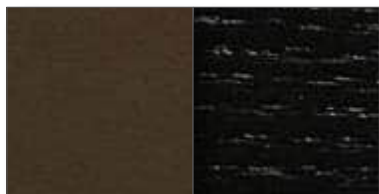

630
MARRONE SCURO/NERO
DARK BROWN/BLACK



620
GRIGIO CHIARO/NERO
LIGHT GREY/BLACK



616
GRIGIO/NERO
GREY/BLACK

CAT.ZA

054 PELLE PURUS - LEATHER PURUS

Chrome tanning, aniline dyed, semi aniline full grain, European bovine hide. Thickness: 1.0/1.2 mm; BS5852

PULIRE SOLO CON PANNINO UMIDO E DETERGENTE NEUTRO/CLEAN ONLY WITH A DAMP CLOTH AND A NEUTRAL DETERGENT



002
BIANCO
WHITE



004
AVORIO
IVORY



152
NUDE
CARNATION

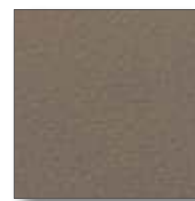

016
TORTORA
TAUPE



033
ARANCIO
ORANGE



039
ROSSO
RED



040
BORDEAUX
BURGUNDY



073
BLU SCURO
DARK BLUE



084
CUOIO
LEATHER



E24
COGNAC
COGNAC



083
MARRONE SCURO
DARK BROWN

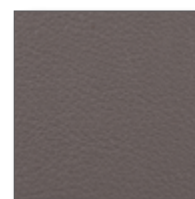

045
GRIGIO CHIARO
LIGHT GREY



050
GRIGIO SCURO
DARK GREY



091
NERO
BLACK

I colori sono indicativi. Non è possibile garantire uniformità di tono nella tintura dei lotti di tessuto. Resta inteso che lievi differenze di colore verranno accettate al momento dell'ordine.

The colors are just indicative. Actually a steady tone of lots cannot be guaranteed. It remains understood that any slight colour difference will be accepted in case an order is placed.

CAT.ZA

083 PELLE PURUS/FRASSINO - LEATHER PURUS/ASH

La Francesea

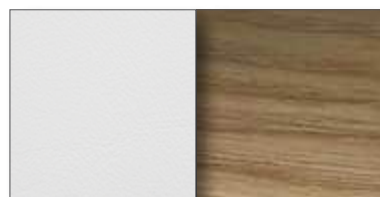

177
BIANCO/NATURALE
WHITE/NATURAL

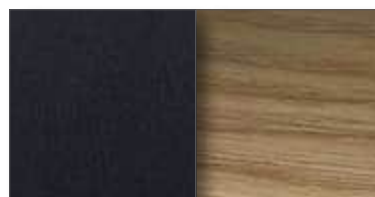

180
BLU SCURO/NATURALE
DARK BLUE/NATURAL

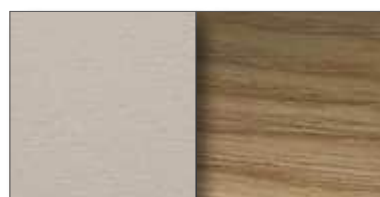

172
AVORIO/NATURALE
IVORY/NATURAL

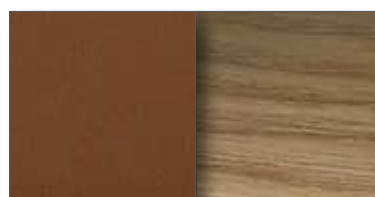

187
CUOIO/NATURALE
LEATHER/NATURAL

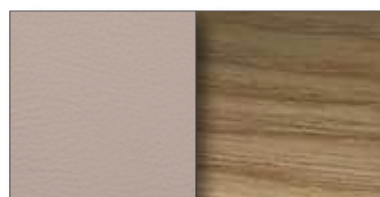

F43
NUDE/NATURALE
CARNATION/NATURAL

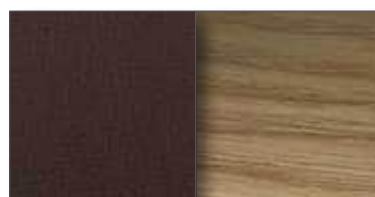

F28
COGNAC/NATURALE
COGNAC/NATURAL



224
TORTORA/NATURALE
TAUPE/NATURAL

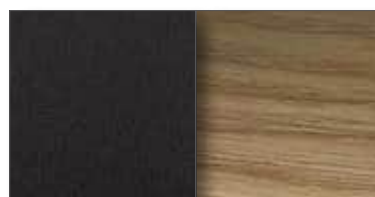

203
MARRONE SCURO/NATURALE
DARK BROWN/NATURAL

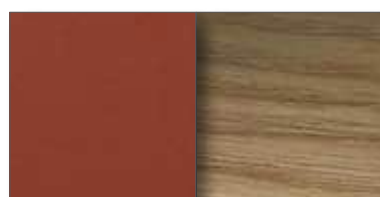

170
ARANCIO/NATURALE
ORANGE/NATURAL

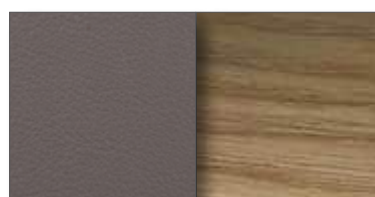

197
GRIGIO CHIARO/NATURALE
LIGHT GREY/NATURAL

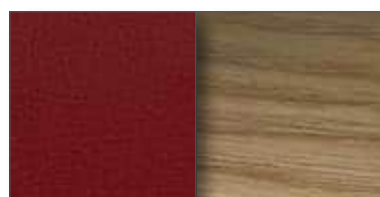

219
ROSSO/NATURALE
RED/NATURAL

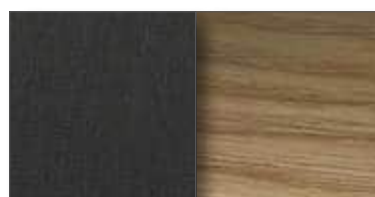

191
GRIGIO SCURO/NATURALE
DARK GREY/NATURAL

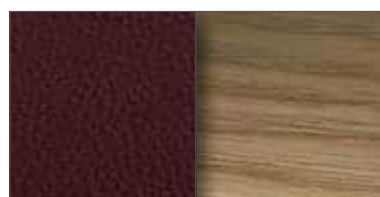

183
BORDEAUX/NATURALE
BURGUNDY/NATURAL

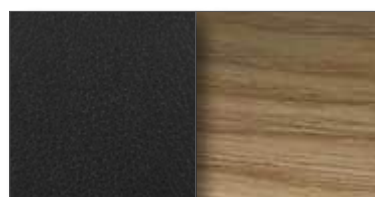

207
NERO/NATURALE
BLACK/NATURAL

CAT.ZA

083 PELLE PURUS/FRASSINO - LEATHER PURUS/ASH

La Francesea

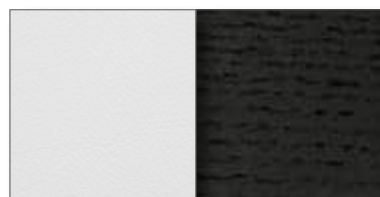

230
BIANCO/EBANIZZATO
WHITE/EBONIZED

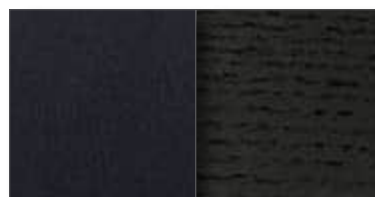

240
BLU SCUROI/EBANIZZATO
DARK BLUE/EBONIZED



233
AVORIO/EBANIZZATO
IVORY/EBONIZED



247
CUOIO/EBANIZZATO
LEATHER/EBONIZED

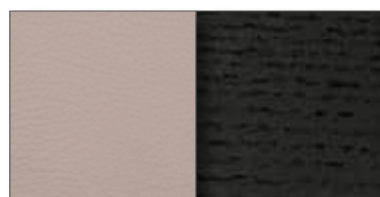

F44
NUDE/EBANIZZATO
CARNATION/EBONIZED

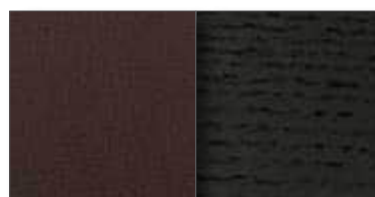

F29
COGNAC/EBANIZZATO
COGNAC/EBONIZED



286
TORTORA/EBANIZZATO
TAUPE/EBONIZED



265
MARRONE SCURO/EBANIZZATO
DARK BROWN/EBONIZED

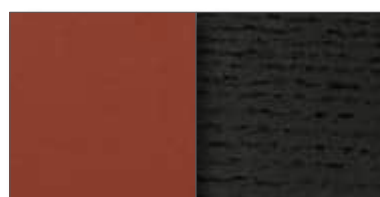

231
ARANCIO/EBANIZZATO
ORANGE/EBONIZED

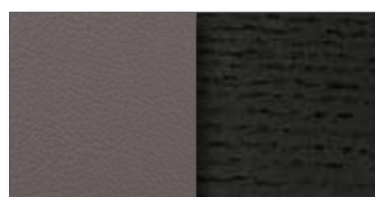

256
GRIGIO CHIARO/EBANIZZATO
LIGHT GREY/EBONIZED

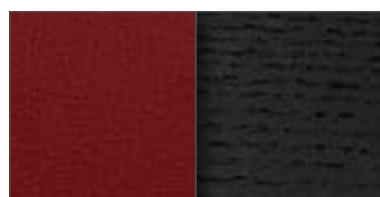

280
ROSSO/EBANIZZATO
RED/EBONIZED



260
GRIGIO SCURO/EBANIZZATO
DARK GREY/EBONIZED

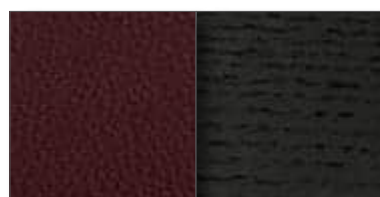

243
BORDEAUX/EBANIZZATO
BURGUNDY/EBONIZED

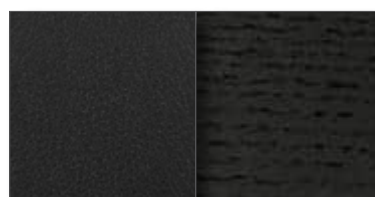

267
NERO/EBANIZZATO
BLACK/EBONIZED

CAT.ZA

152 PELLE PURUS/ACCIAIO VERNICIATO - LEATHER PURUS/PAINTED STEEL

Costes

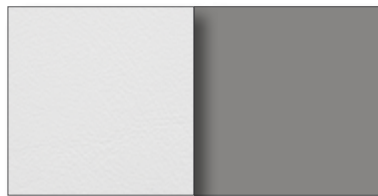

297
BIANCO/TITANIO
WHITE/TITANIUM

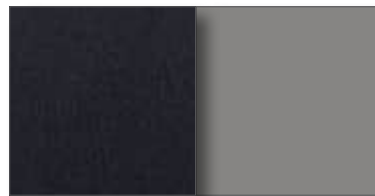

F60
BLU SCURO/TITANIO
DARK BLUE/TITANIUM



294
AVORIO/TITANIO
IVORY/TITANIUM



302
CUOIO/TITANIO
LEATHER/TITANIUM

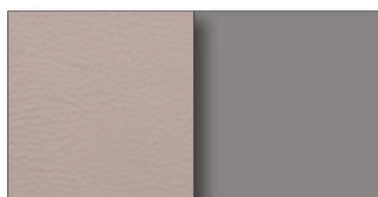

F59
NUDE/TITANIO
CARNATION/TITANIUM



F30
COGNAC/TITANIO
COGNAC/TITANIUM

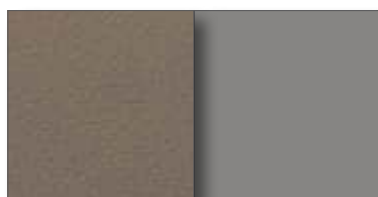

E79
TORTORA/TITANIO
TAUPE/TITANIUM

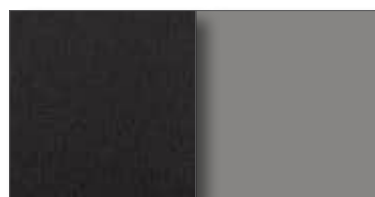

E82
MARRONE SCURO/TITANIO
DARK BROWN/TITANIUM

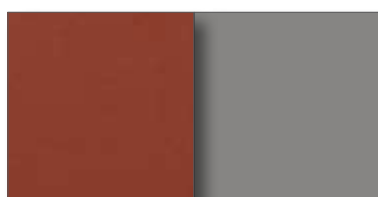

292
ARANCIO/TITANIO
ORANGE/TITANIUM

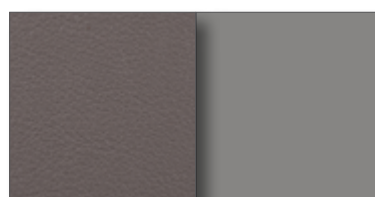

308
GRIGIO CHIARO/TITANIO
LIGHT GREY/TITANIUM

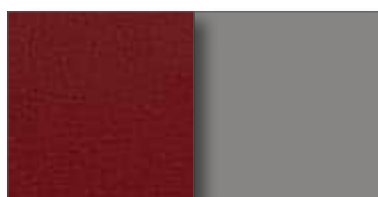

314
ROSSO/TITANIO
RED/TITANIUM



304
GRIGIO SCURO/TITANIO
DARK GREY/TITANIUM

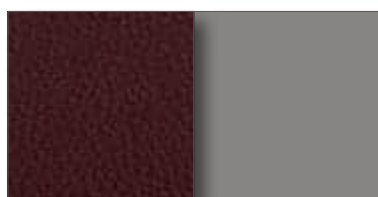

299
BORDEAUX/TITANIO
BURGUNDY/TITANIUM

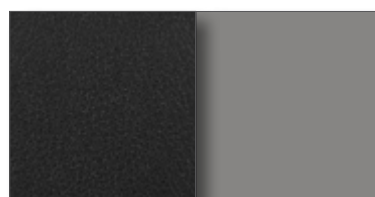

311
NERO/TITANIO
BLACK/TITANIUM

CAT.ZA

152 PELLE PURUS/ACCIAIO VERNICIATO - LEATHER PURUS/PAINTED STEEL

Fenix

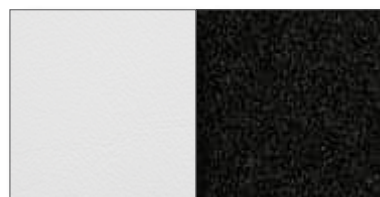

442
BIANCO/PELTRO BRONZATO
WHITE/BRONZE PEWTER

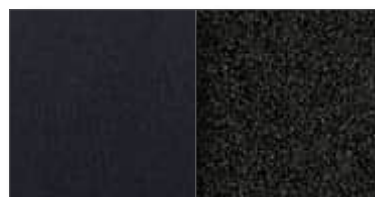

448
BLU SCURO/PELTRO BRONZATO
DARK BLUE/BRONZE PEWTER



436
AVORIO/PELTRO BRONZATO
IVORY/BRONZE PEWTER



456
CUOIO/PELTRO BRONZATO
LEATHER/BRONZE PEWTER

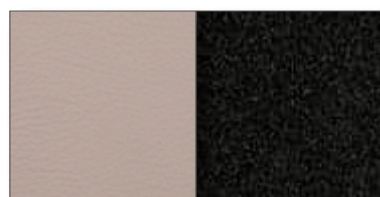

F48
NUDE/PELTRO BRONZATO
CARNATION/BRONZE PEWTER

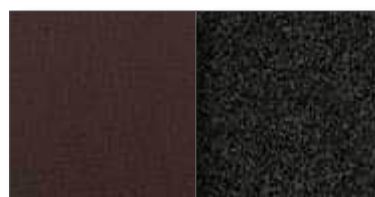

F34
COGNAC/PELTRO BRONZATO
COGNAC/BRONZE PEWTER

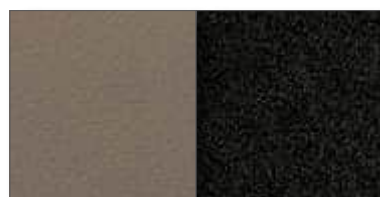

501
TORTORA/PELTRO BRONZATO
TAUPE/BRONZE PEWTER



477
MARRONE SCURO/PELTRO BRONZATO
DARK BROWN/BRONZE PEWTER



434
ARANCIO/PELTRO BRONZATO
ORANGE/BRONZE PEWTER

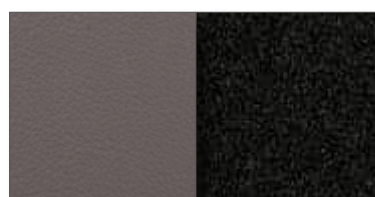

466
GRIGIO CHIARO/PELTRO BRONZATO
LIGHT GREY/BRONZE PEWTER

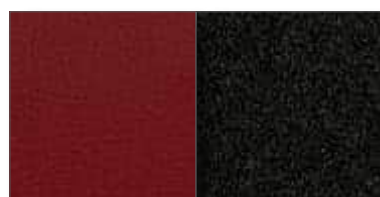

494
ROSSO/PELTRO BRONZATO
RED/BRONZE PEWTER



471
GRIGIO SCURO/PELTRO BRONZATO
DARK GREY/BRONZE PEWTER



451
BORDEAUX/PELTRO BRONZATO
BURGUNDY/BRONZE PEWTER

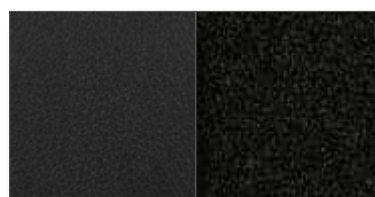

479
NERO/PELTRO BRONZATO
BLACK/BRONZE PEWTER

CAT.ZA

152 PELLE PURUS/ACCIAIO VERNICIATO - LEATHER PURUS/PAINTED STEEL

Wireflow

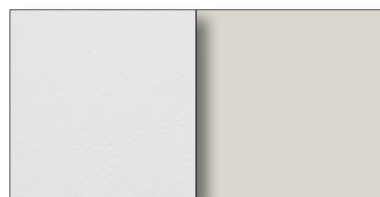

669
BIANCO/BIANCO
WHITE/WHITE

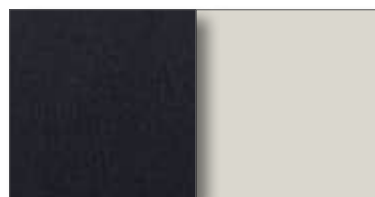

672
BLU SCURO/BIANCO
DARK BLUE/WHITE

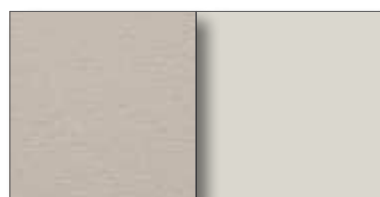

666
AVORIO/BIANCO
IVORY/WHITE

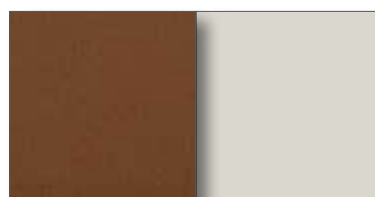

679
CUOIO/BIANCO
LEATHER/WHITE

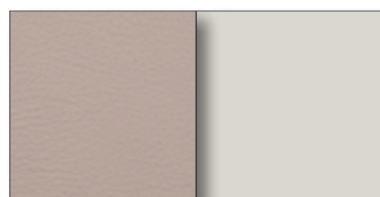

F47
NUDE/BIANCO
CARNATION/WHITE

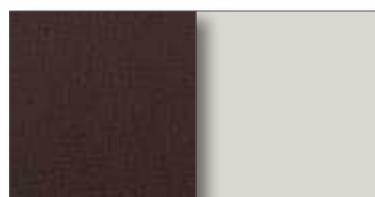

F33
COGNAC/BIANCO
COGNAC/WHITE

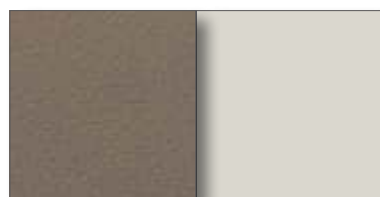

709
TORTORA/BIANCO
TAUPE/WHITE



692
MARRONE SCURO/BIANCO
DARK BROWN/WHITE

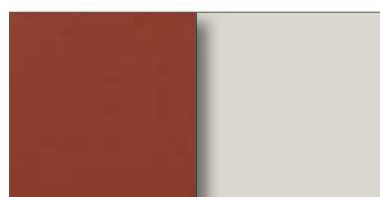

664
ARANCIO/BIANCO
ORANGE/WHITE

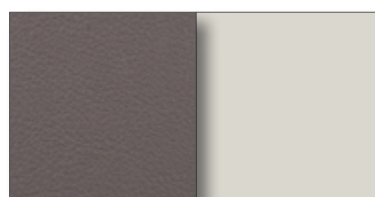

686
GRIGIO CHIARO/BIANCO
LIGHT GREY/WHITE

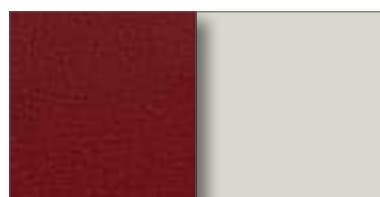

704
ROSSO/BIANCO
RED/WHITE



688
GRIGIO SCURO/BIANCO
DARK GREY/WHITE

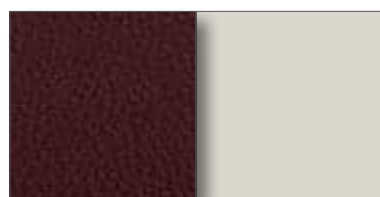

675
BORDEAUX/BIANCO
BURGUNDY/WHITE

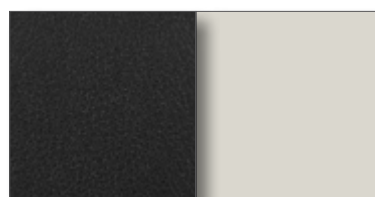

694
NERO/BIANCO
BLACK/WHITE

CAT.ZA

152 PELLE PURUS/ACCIAIO VERNICIATO - LEATHER PURUS/PAINTED STEEL

Wireflow, Cocky

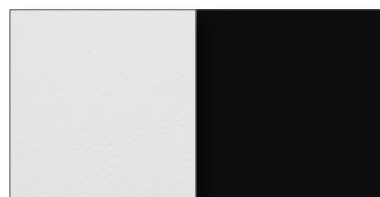

596
BIANCO/NERO
WHITE/BLACK

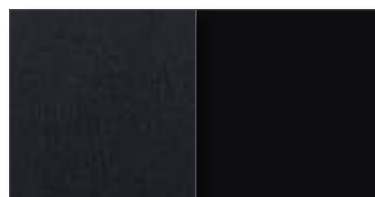

602
BLU SCURO/NERO
DARK BLUE/BLACK

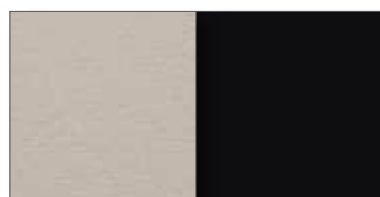

590
AVORIO/NERO
IVORY/BLACK



610
CUOIO/NERO
LEATHER/BLACK

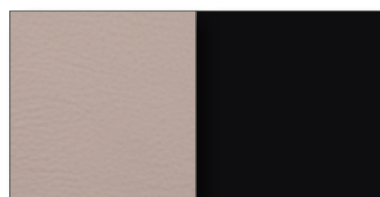

F46
NUDE/NERO
CARNATION/BLACK

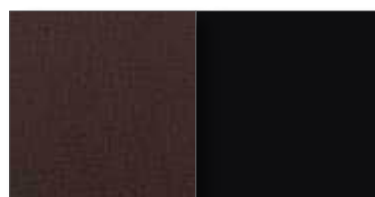

F32
COGNAC/NERO
COGNAC/BLACK

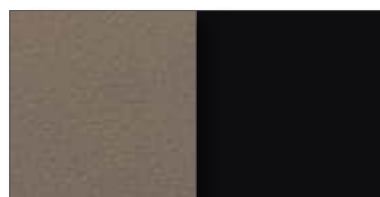

655
TORTORA/NERO
TAUPE/BLACK



630
MARRONE SCURO/NERO
DARK BROWN/BLACK



588
ARANCIO/NERO
ORANGE/BLACK

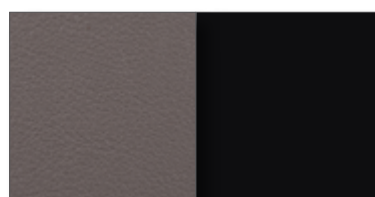

620
GRIGIO CHIARO/NERO
LIGHT GREY/BLACK

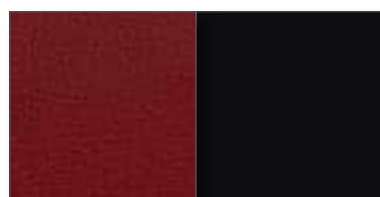

647
ROSSO/NERO
RED/BLACK

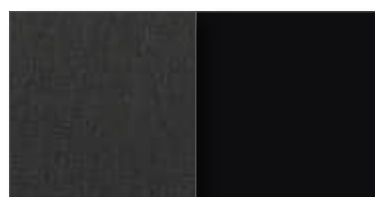

625
GRIGIO SCURO/NERO
DARK GREY/BLACK

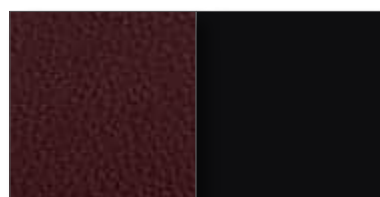

605
BORDEAUX/NERO
BURGUNDY/BLACK

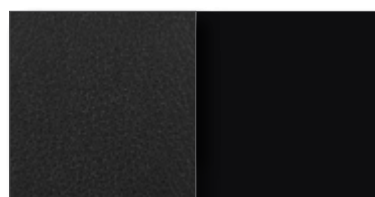

632
NERO/NERO
BLACK/BLACK

CAT.ZA

152 PELLE PURUS/ACCIAIO VERNICIATO - LEATHER PURUS/PAINTED STEEL

Elisa

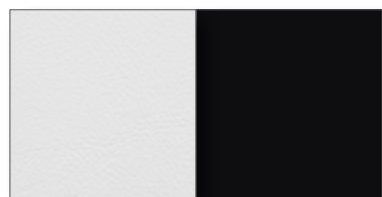

393
BIANCO/NERO MARRONE
WHITE/BLACK BROWN

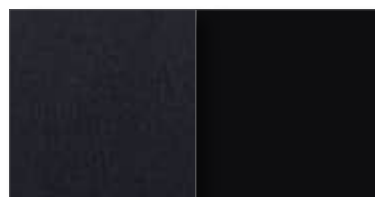

398
BLU SCURO/NERO MARRONE
DARK BLUE/BLACK BROWN

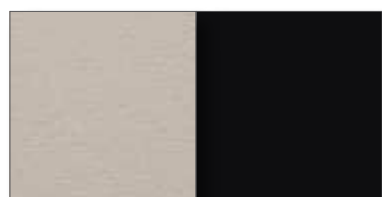

388
AVORIO/NERO MARRONE
IVORY/BLACK BROWN

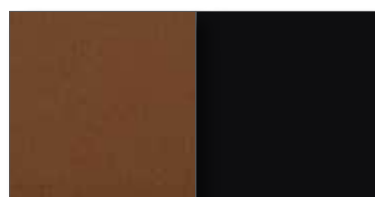

G57
CUOIO/NERO MARRONE
LEATHER/BLACK

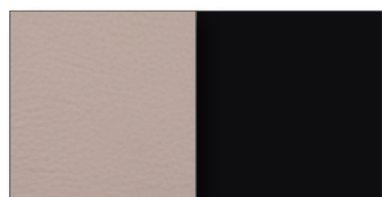

G60
NUDE/NERO MARRONE
CARNATION/BLACK BROWN

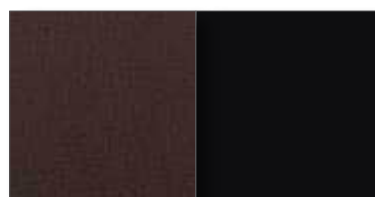

G61
COGNAC/NERO MARRONE
COGNAC/BLACK BROWN

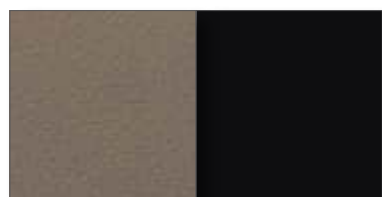

427
TORTORA/NERO MARRONE
TAUPE/BLACK BROWN



415
MARRONE SCURO/NERO MARRONE
DARK BROWN/BLACK BROWN



387
ARANCIO/NERO MARRONE
ORANGE/BLACK BROWN

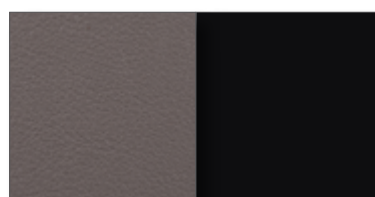

407
GRIGIO CHIARO/NERO MARRONE
LIGHT GREY/BLACK BROWN

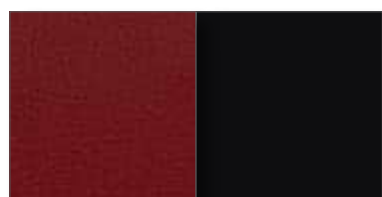

424
ROSSO/NERO MARRONE
RED/BLACK BROWN

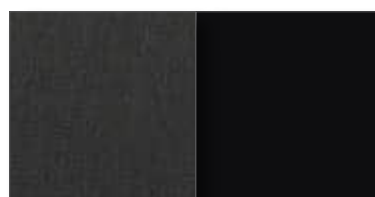

411
GRIGIO SCURO/NERO MARRONE
DARK GREY/BLACK BROWN

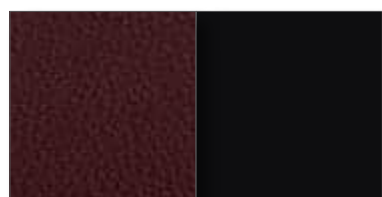

401
BORDEAUX/NERO MARRONE
BURGUNDY/BLACK BROWN

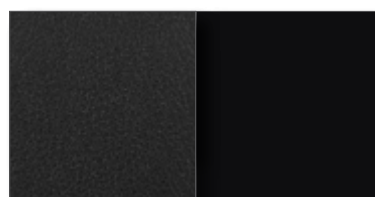

417
NERO/NERO MARRONE
BLACK/BLACK BROWN

CAT.ZA

188 PELLE PURUS/ACCIAIO CROMATO - LEATHER PURUS/CROMED STEEL

Moon, Cocky

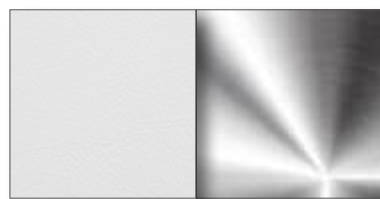

B00
BIANCO/CROMO
WHITE/CHROME

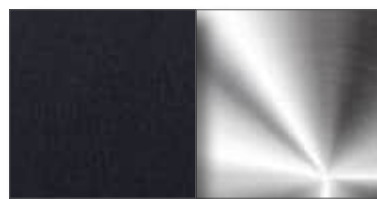

F61
BLU SCURO/CROMO
DARK BLUE/CHROME



C36
AVORIO/CROMO
IVORY/CHROME



C45
CUOIO/CROMO
LEATHER/CHROME

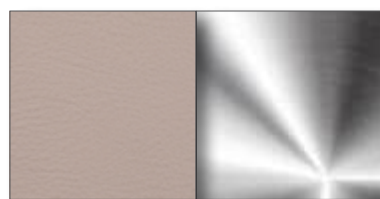

F49
NUDE/CROMO
CARNATION/CHROME

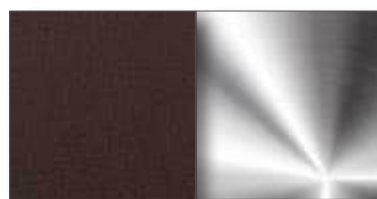

F35
COGNAC/CROMO
COGNAC/CHROME



E86
TORTORA/CROMO
TAUPE/CHROME

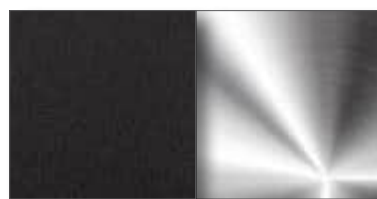

C53
MARRONE SCURO/CROMO
DARK BROWN/CHROME



C34
ARANCIO/CROMO
ORANGE/CHROME

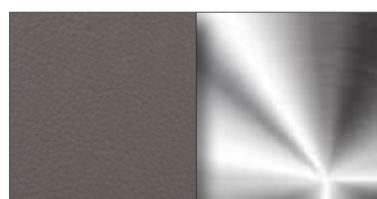

C51
GRIGIO CHIARO/CROMO
LIGHT GREY/CHROME



C58
ROSSO/CROMO
RED/CHROME



C47
GRIGIO SCURO/CROMO
DARK GREY/CHROME



C41
BORDEAUX/CROMO
BURGUNDY/CHROME



B01
NERO/CROMO
BLACK/CHROME

CAT.ZA

217 PELLE PURUS/ALLUMINIO LUCIDATO - LEATHER PURUS/POLISHED ALUMINUM

Lou Speak. Cocky

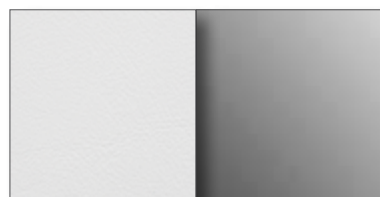

531
BIANCO/ALLUMINIO
WHITE/ALUMINUM

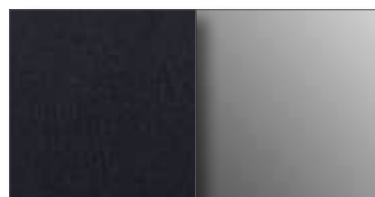

534
BLU SCURO/ALLUMINIO
DARK BLUE/ALUMINUM

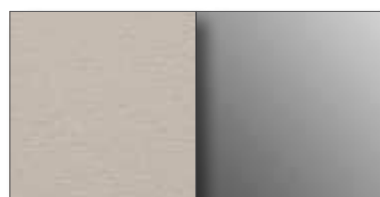

526
AVORIO/ALLUMINIO
IVORY/ALUMINUM

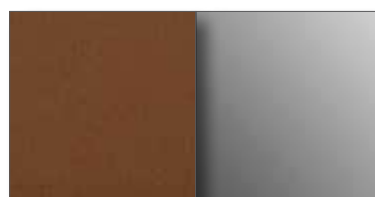

541
CUOIO/ALLUMINIO
LEATHER/ALUMINUM

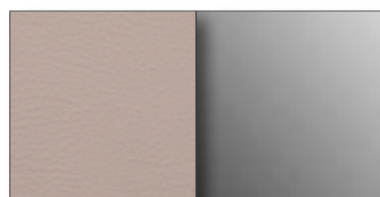

F50
NUDE/ALLUMINIO
CARNATION/ALUMINUM



F36
COGNAC/ALLUMINIO
COGNAC/ALUMINUM

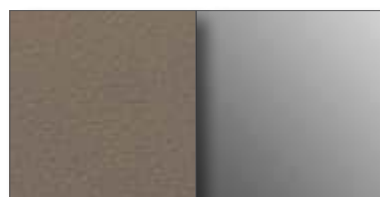

582
TORTORA/ALLUMINIO
TAUPE/ALUMINUM



559
MARRONE SCURO/ALLUMINIO
DARK BROWN/ALUMINUM

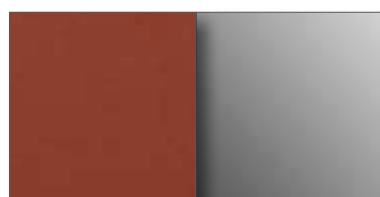

524
ARANCIO/ALLUMINIO
ORANGE/ALUMINUM

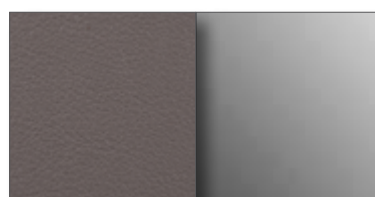

550
GRIGIO CHIARO/ALLUMINIO
LIGHT GREY/ALUMINUM

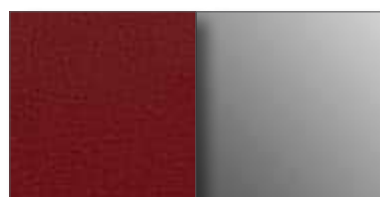

575
ROSSO/ALLUMINIO
RED/ALUMINUM



554
GRIGIO SCURO/ALLUMINIO
DARK GREY/ALUMINUM

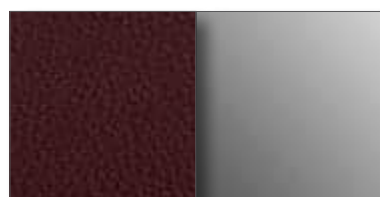

537
BORDEAUX/ALLUMINIO
BURGUNDY/ALUMINUM

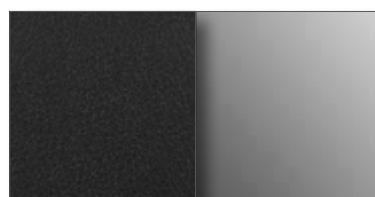

561
NERO/ALLUMINIO
BLACK/ALUMINUM

CAT.ZA

246 PELLE PURUS/ALLUMINIO VERNICIATO - LEATHER PURUS/PAINTED ALUMINUM

Lirica, Lirico

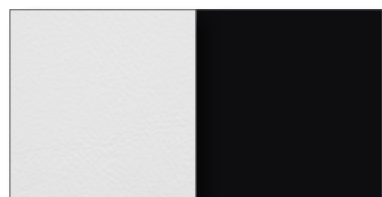

596
BIANCO/NERO
WHITE/BLACK

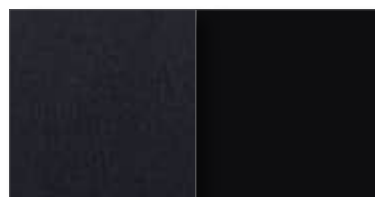

602
BLU SCURO/NERO
DARK BLUE/BLACK

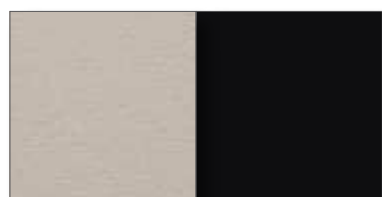

590
AVORIO/NERO
IVORY/BLACK

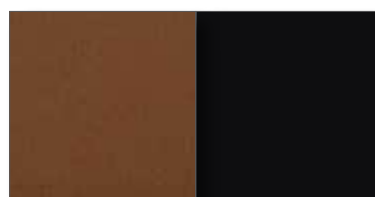

610
CUOIO/NERO
LEATHER/BLACK

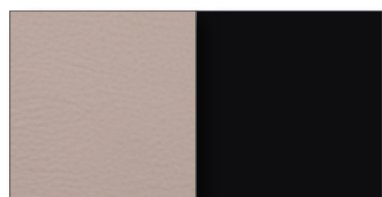

F46
NUDE/NERO
CARNATION/BLACK

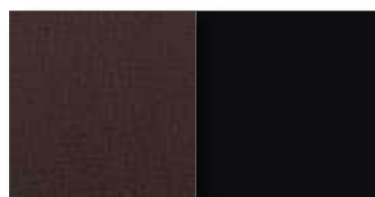

F32
COGNAC/NERO
COGNAC/BLACK

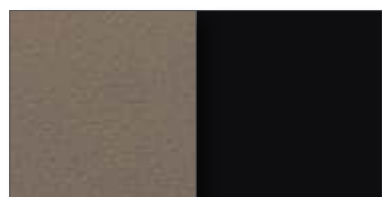

655
TORTORA/NERO
TAUPE/BLACK



630
MARRONE SCURO/NERO
DARK BROWN/BLACK



588
ARANCIO/NERO
ORANGE/BLACK

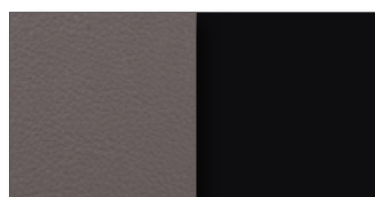

620
GRIGIO CHIARO/NERO
LIGHT GREY/BLACK

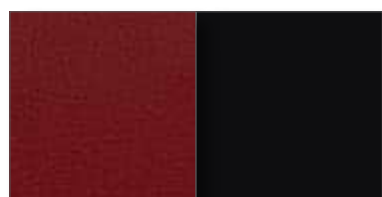

647
ROSSO/NERO
RED/BLACK

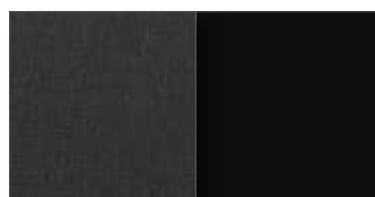

625
GRIGIO SCURO/NERO
DARK GREY/BLACK

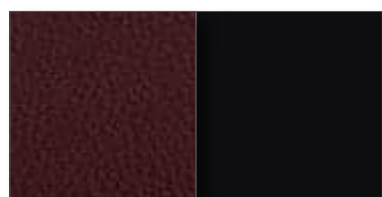

605
BORDEAUX/NERO
BURGUNDY/BLACK

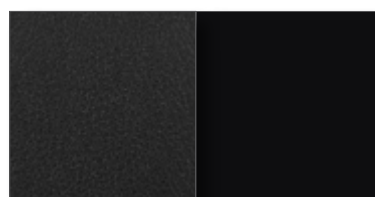

632
NERO/NERO
BLACK/BLACK

CAT.ZA

246 PELLE PURUS/ALLUMINIO VERNICIATO - LEATHER PURUS/PAINTED ALUMINUM

Lirica, Lirico

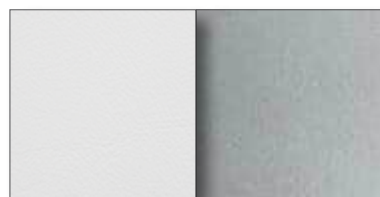

722
BIANCO/ARGENTO
WHITE/SILVER



728
BLU SCURO/ARGENTO
DARK BLUE/SILVER

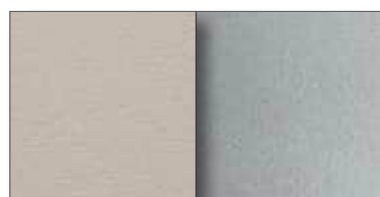

716
AVORIO/ARGENTO
IVORY/SILVER

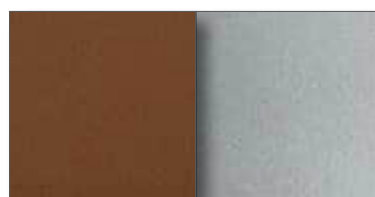

736
CUOIO/ARGENTO
LEATHER/SILVER

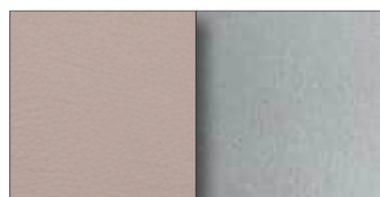

F51
NUDE/ARGENTO
CARNATION/SILVER



F37
COGNAC/ARGENTO
COGNAC/SILVER

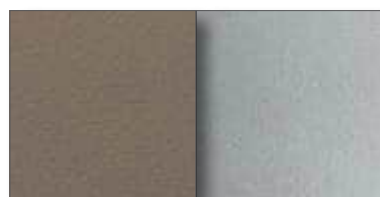

782
TORTORA/ARGENTO
TAUPE/SILVER



757
MARRONE SCURO/ARGENTO
DARK BROWN/SILVER

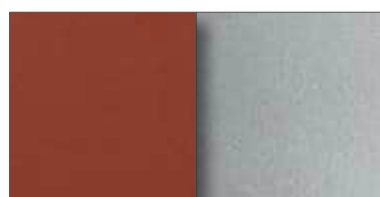

714
ARANCIO/ARGENTO
ORANGE/SILVER

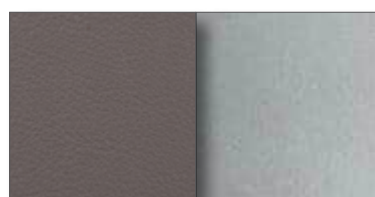

746
GRIGIO CHIARO/ARGENTO
LIGHT GREY/SILVER



714
ROSSO/ARGENTO
RED/SILVER



751
GRIGIO SCURO/ARGENTO
DARK GREY/SILVER



731
BORDEAUX/ARGENTO
BURGUNDY/SILVER



759
NERO/ARGENTO
BLACK/SILVER

CAT.ZA

339 PELLE PURUS/FAGGIO LACCATO - LEATHER PURUS/LACQUERED BEECH

S.Marco, S.Marco Lounge

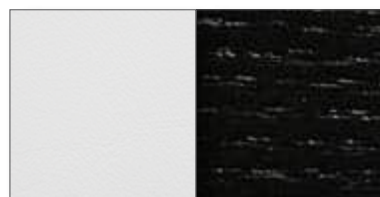

596
BIANCO/NERO
WHITE/BLACK

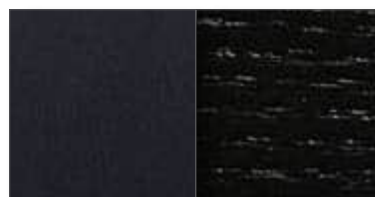

602
BLU SCURO/NERO
DARK BLUE/BLACK



590
AVORIO/NERO
IVORY/BLACK

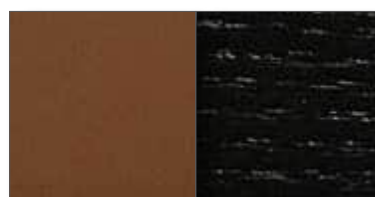

610
CUOIO/NERO
LEATHER/BLACK

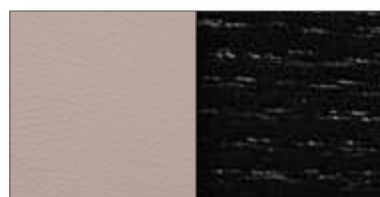

F46
NUDE/NERO
CARNATION/BLACK



F32
COGNAC/NERO
COGNAC/BLACK

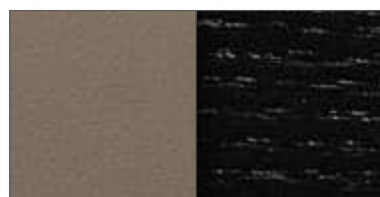

655
TORTORA/NERO
TAUPE/BLACK



630
MARRONE SCURO/NERO
DARK BROWN/BLACK

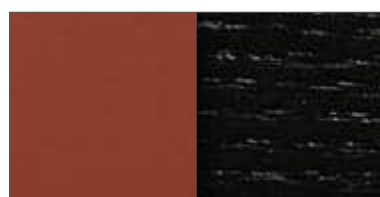

588
ARANCIO/NERO
ORANGE/BLACK

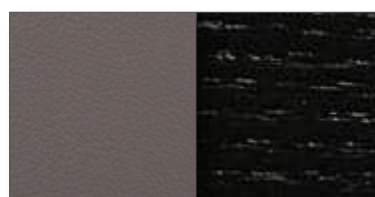

620
GRIGIO CHIARO/NERO
LIGHT GREY/BLACK



647
ROSSO/NERO
RED/BLACK



625
GRIGIO SCURO/NERO
DARK GREY/BLACK



605
BORDEAUX/NERO
BURGUNDY/BLACK

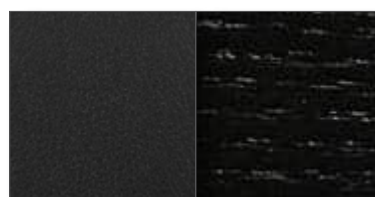

632
NERO/NERO
BLACK/BLACK

CAT.ZA

421 PU RIGIDO VERNICIATO/PELLE PURUS/ACCIAIO CROMATO
STIFF PAINTED PU/LEATHER PURUS/CHROMED STEEL

Moon

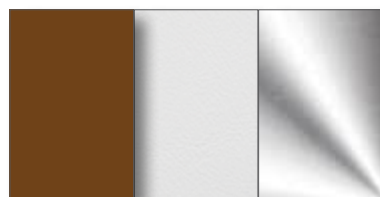

864
MATTONE/BIANCO/CROMO
RED BRICK/WHITE/CHROME

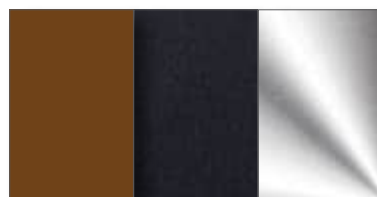

869
MATTONE/BLU SCURO/CROMO
RED BRICK/DARK BLUE/CHROME

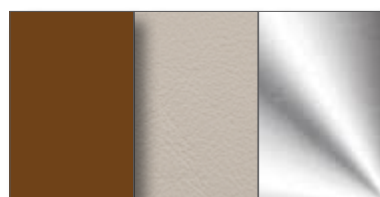

859
MATTONE/AVORIO/CROMO
RED BRICK/IVORY/CHROME

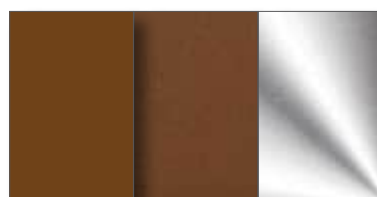

876
MATTONE/CUOIO/CROMO
RED BRICK/LEATHER/CHROME

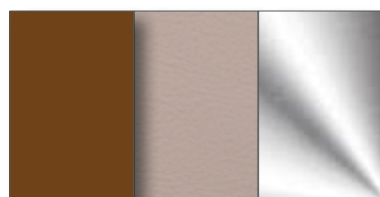

F53
MATTONE/NUDE/CROMO
RED BRICK/CARNATION/CHROME

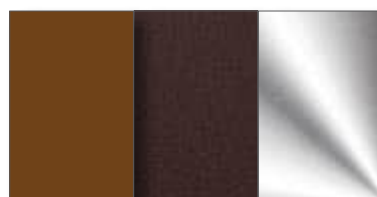

F39
MATTONE/COGNAC/CROMO
RED BRICK/COGNAC/CHROME

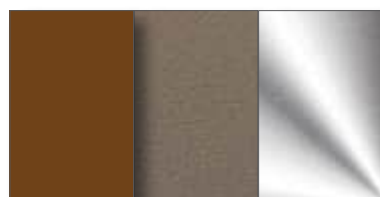

920
MATTONE/TORTORA/CROMO
RED BRICK/TAUPE/CHROME

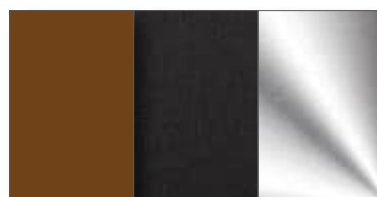

897
MATTONE/MARRONE SCURO/CROMO
RED BRICK/DARK BROWN/CHROME

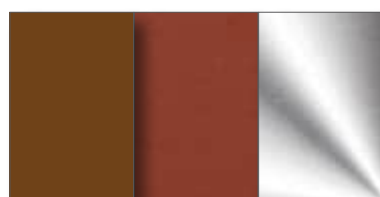

857
MATTONE/ARANCIO/CROMO
RED BRICK/ORANGE/CHROME

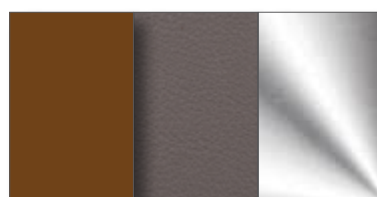

886
MATTONE/GRIGIO CHIARO/CROMO
RED BRICK/LIGHT GREY/CHROME

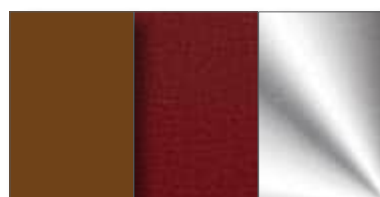

912
MATTONE/ROSSO/CROMO
RED BRICK/RED/CHROME

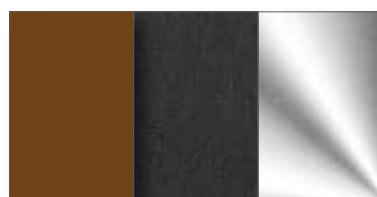

891
MATTONE/GRIGIO SCURO/CROMO
RED BRICK/DARK GREY/CHROME



872
MATTONE/BORDEAUX/CROMO
RED BRICK/BURGUNDY/CHROME

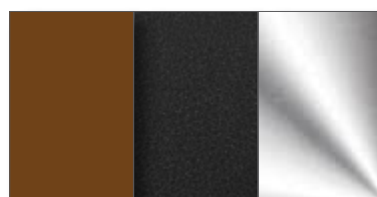

899
MATTONE/NERO/CROMO
RED BRICK/BLACK/CHROME

CAT.ZA

421 PU RIGIDO VERNICIATO/PELLE PURUS/ACCIAIO CROMATO
STIFF PAINTED PU/LEATHER PURUS/CHROMED STEEL

Moon

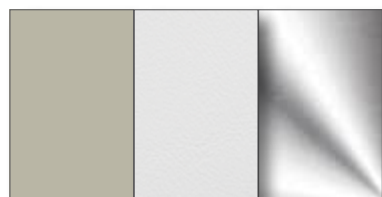

936
ECRU/BIANCO/CROMO
ECRU/WHITE/CHROME

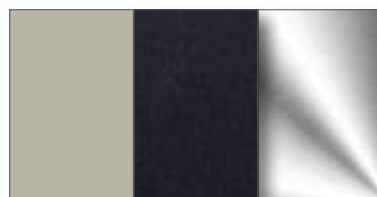

941
ECRU/BLU SCURO/CROMO
ECRU/DARK BLUE/CHROME

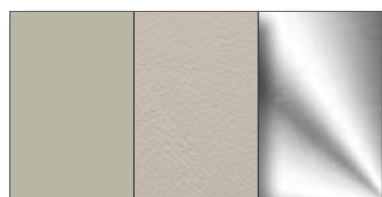

931
ECRU/AVORIO/CROMO
ECRU/IVORY/CHROME

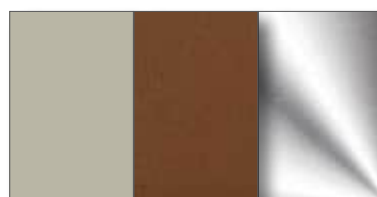

948
ECRU/CUOIO/CROMO
ECRU/LEATHER/CHROME

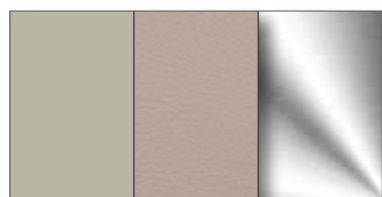

F54
ECRU/NUDE/CROMO
ECRU/CRNATION/CHROME

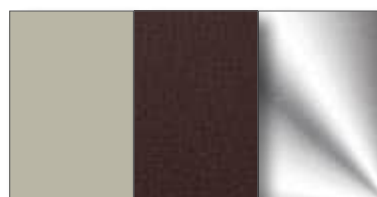

F40
ECRU/COGNAC/CROMO
ECRU/COGNAC/CHROME

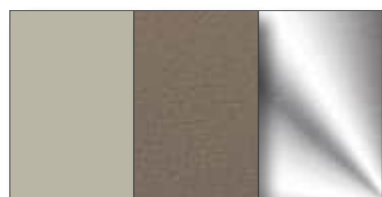

992
ECRU/TORTORA/CROMO
ECRU/TAUPE/CHROME

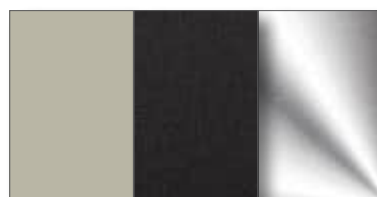

969
ECRU/MARRONE SCURO/CROMO
ECRU/DARK BROWN/CHROME

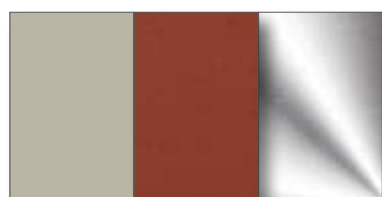

929
ECRU/ARANCIO/CROMO
ECRU/ORANGE/CHROME

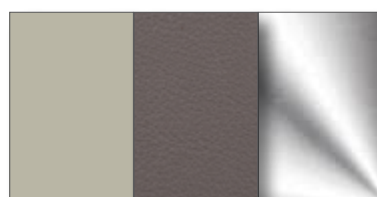

958
ECRU/GRIGIO CHIARO/CROMO
ECRU/LIGHT GREY/CHROME

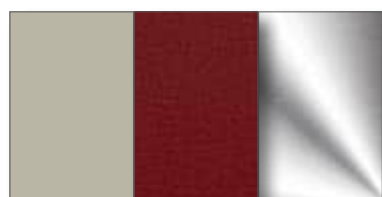

985
ECRU/ROSSO/CROMO
ECRU/RED/CHROME

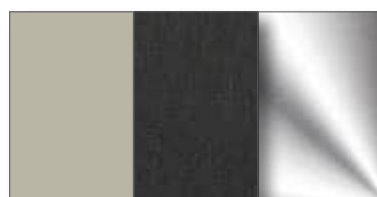

963
ECRU/GRIGIO SCURO/CROMO
ECRU/DARK GREY/CHROME

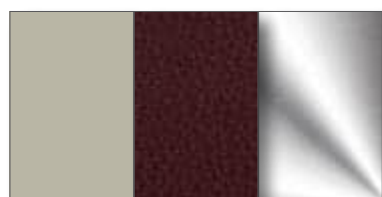

944
ECRU/BORDEAUX/CROMO
ECRU/BURGUNDY/CHROME

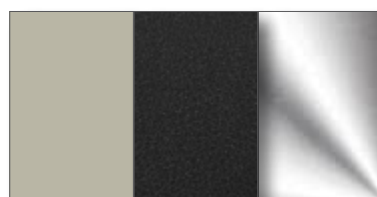

971
ECRU/NERO/CROMO
ECRU/BLACK/CHROME

CAT.ZA

421 PU RIGIDO VERNICIATO/PELLE PURUS/ACCIAIO CROMATO
STIFF PAINTED PU/LEATHER PURUS/CHROMED STEEL

Moon



A08
NERO/BIANCO/CROMO
BLACK/WHITE/CHROME

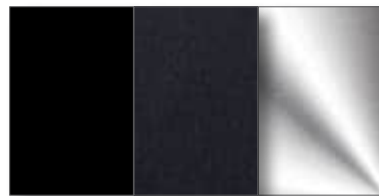

A13
NERO/BLU SCURO/CROMO
BLACK/DARK BLUE/CHROME

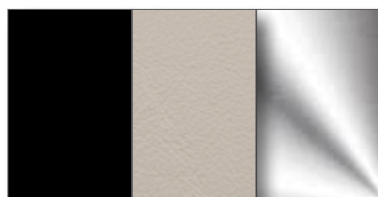

A03
NERO/AVORIO/CROMO
BLACK/IVORY/CHROME

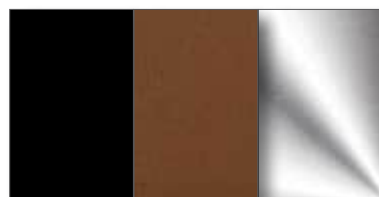

A20
NERO/CUOIO/CROMO
BLACK/LEATHER/CHROME

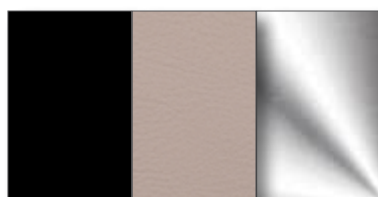

F55
NERO/NUDE/CROMO
BLACK/CRNATION/CHROME

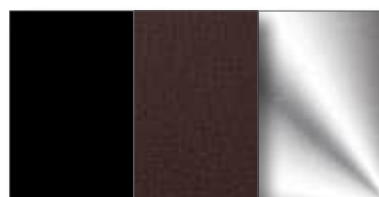

F41
NERO/COGNAC/CROMO
BLACK/COGNAC/CHROME

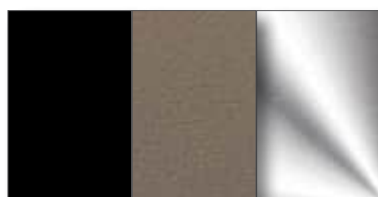

A64
NERO/TORTORA/CROMO
BLACK/TAUPE/CHROME

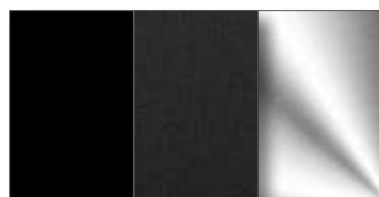

A41
NERO/MARRONE SCURO/CROMO
BLACK/DARK BROWN/CHROME

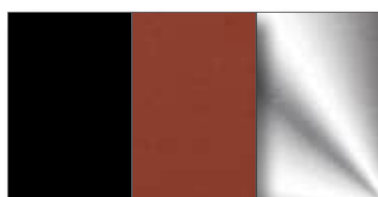

A01
NERO/ARANCIO/CROMO
BLACK/ORANGE/CHROME

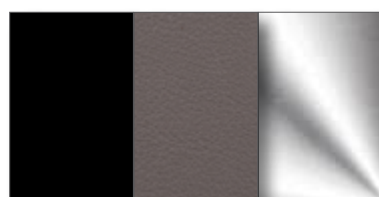

A30
NERO/GRIGIO CHIARO/CROMO
BLACK/LIGHT GREY/CHROME

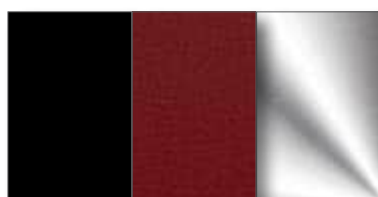

A57
NERO/ROSSO/CROMO
BLACK/RED/CHROME

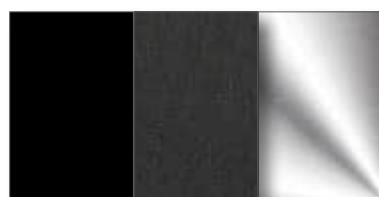

A35
NERO/GRIGIO SCURO/CROMO
BLACK/DARK GREY/CHROME

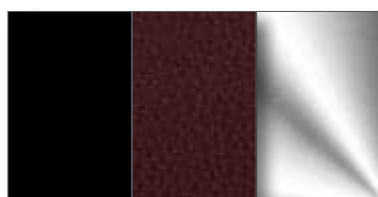

A16
NERO/BORDEAUX/CROMO
BLACK/BURGUNDY/CHROME

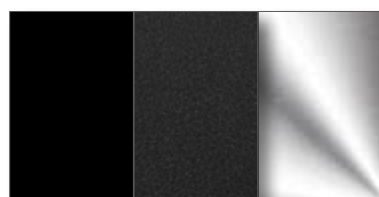

A43
NERO/NERO/CROMO
BLACK/BLACK/CHROME

VETRI/GLASSES

349 VETRO ACIDATO/FRASSINO/ ALLUMINIO ANODIZZATO
 FROSTED GLASS/ ASH/ANODIZED ALUMINUM

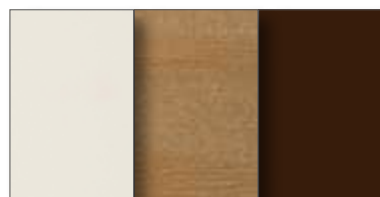

D51
 BIANCO PURO OPACO/TINTO ROVERE/
 TESTA DI MORO
 MATT PURE WHITE/STAINED OAK/DARK
 BROWN

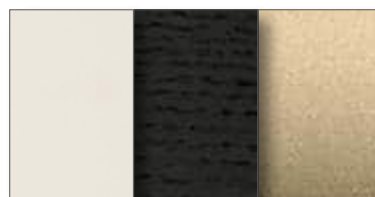

D52
 BIANCO PURO OPACO/EBANIZZATO/
 BRONZO
 MATT PURE WHITE/EBONIZED/BRONZE

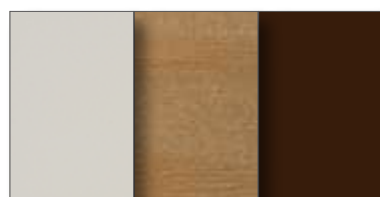

D53
 BIANCO NUVOLA OPACO/TINTO ROVERE/
 TESTA DI MORO
 MATT CLOUD WHITE/STAINED OAK/DARK
 BROWN

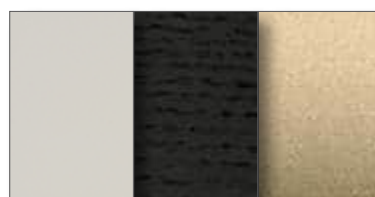

D54
 BIANCO NUVOLA OPACO/EBANIZZATO/
 BRONZO
 MATT CLOUD WHITE/EBONIZED/BRONZE



D55
 SABBIA OPACO/TINTO ROVERE/TESTA DI
 MORO
 MATT SAND/STAINED OAK/DARK BROWN

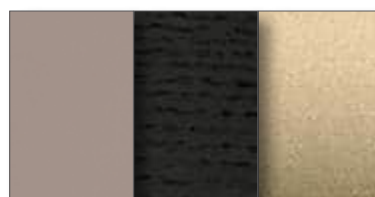

D56
 SABBIA OPACO/EBANIZZATO/BRONZO
 MATT SAND/EBONIZED/BRONZE



D57
 ROSSO OPACO/TINTO ROVERE/TESTA DI
 MORO
 MATT RED/STAINED OAK/DARK BROWN

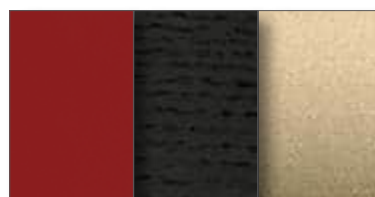

D58
 ROSSO OPACO/EBANIZZATO/BRONZO
 MATT RED/EBONIZED/BRONZE



D59
 MACCHIA MED. OPACO/TINTO ROVERE/
 TESTA DI MORO
 MATT MAQUIS SHRUBLAND/STAINED
 OAK/DARK BROWN

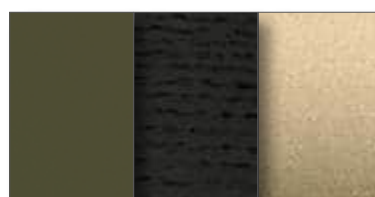

D60
 MACCHIA MED. OPACO/EBANIZZATO/
 BRONZO
 MATT MAQUIS SHRUBLAND/EBONIZED/
 BRONZE



D61
 MOCACCINO OPACO/TINTO ROVERE/
 TESTA DI MORO
 MATT MOCHACCINO/STAINED OAK/DARK
 BROWN

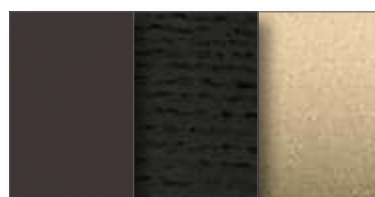

D62
 MOCACCINO OPACO/EBANIZZATO/
 BRONZO
 MATT MOCHACCINO/EBONIZED/BRONZE

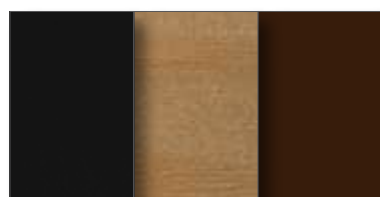

D63
 NERO LAVAGNA OPACO/TINTO ROVERE/
 TESTA DI MORO
 MATT BLACKBOARD BLACK/STAINED
 OAK/DARK BROWN

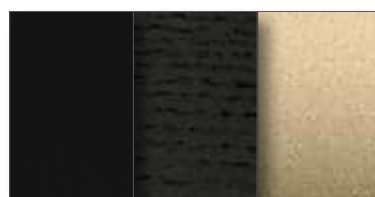

D64
 NERO LAVAGNA OPACO/EBANIZZATO/
 BRONZO
 MATT BLACKBOARD BLACK/EBONIZED/
 BRONZE

VETRI/GLASSES

356 VETRO LACCATO/FRASSINO

LACQUERED GLASS/ASH

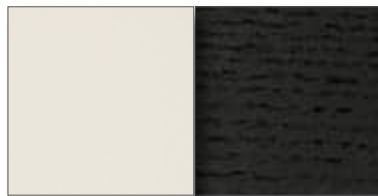

D65

BIANCO PURO LUCIDO/EBANIZZATO
GLOSSY PURE WHITE/EBONIZED

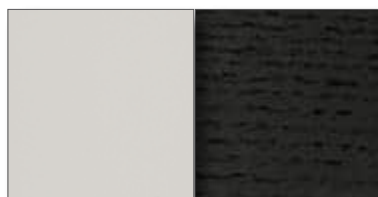

D66

BIANCO NUVOLA LUCIDO/EBANIZZATO
GLOSSY CLOUD WHITE/EBONIZED

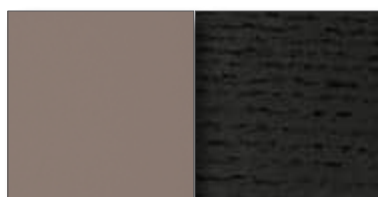

D67

SABBIA LUCIDO/EBANIZZATO
GLOSSY SAND/EBONIZED



D68

ROSSO LUCIDO/EBANIZZATO
GLOSSY RED/EBONIZED

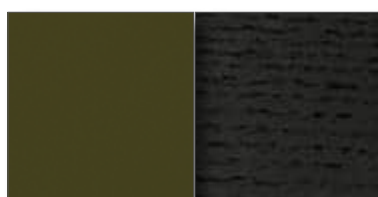

D69

MACCHIA MED. LUCIDO/EBANIZZATO
GLOSSY MAQUIS SHRUBLAND/EBONIZED

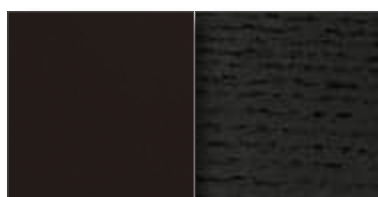

D70

MOCACCINO LUCIDO/EBANIZZATO
GLOSSY MOCHACCINO/EBONIZED

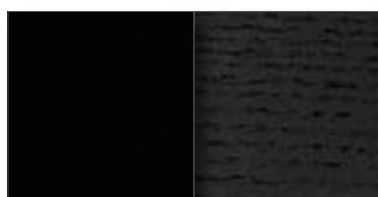

D71

NERO LAVAGNA LUCIDO/EBANIZZATO
GLOSSY BLACKBOARD BLACK/EBONIZED

LIBRO DELLE FINITURE 2023
FINISHES BOOK 2023

COMPOSITI/COMPOSITES

Nella scienza dei materiali un “materiale composito” è un materiale eterogeneo, cioè costituito da due o più fasi con proprietà fisiche differenti le cui proprietà finali sono significativamente migliori di quelle delle fasi che lo costituiscono sia dal punto di vista meccanico che estetico. I primi materiali compositi furono i mattoni, il calcestruzzo ed il compensato sino ad arrivare ai nostri giorni con i recenti compositi a matrice polimerica, metallica, ceramica ed i compositi strutturati come i pannelli a sandwich.

In the science of materials, a “composite material” is heterogeneous, consisting, that is, of two or more phases with different physical properties, the final properties of which are significantly better than those of the phases that comprise it, from both the mechanical and the aesthetic perspectives.

The first composite materials were bricks, concrete and plywood; then, if we move on to more recent times, we have the newer composites, which are polymer-, metal- and ceramic-based and structured composites such as sandwich panels.

FINITURA CEMENTO/CEMENT FINISH

Impasto realizzato con cemento, additivi-resine, sabbie di varie granulometrie e fib e di vetro. Il composto ottenuto permette di ridurre il peso e mantenere la durabilità del manufatto. A stagionatura avvenuta gli elementi vengono trattati con prodotti protettivi ed impermeabili. Anche in un singolo pezzo la struttura, la tonalità e la porosità non saranno mai completamente uniformi, piccole formazioni di pori e bande, minime differenze di colore o leggere fenditure fanno parte delle caratteristiche naturali del materiale e contribuiscono al pregio ed al valore individuale di ogni singolo pezzo.

A mix made with cement, additives-resins, sands with various particle sizes and glass fibres. The compound obtained enables the weight to be reduced and the durability of the product to be maintained. When seasoning is completed, the elements are treated with protective and impermeable products. Even in a single piece, the structure, colour tone and porosity will never be completely uniform; small formations of pores and bands, minor differences in colour and slight fissures are all part of the natural characteristics of the material and contribute to the quality and value of each individual piece.

FINITURA ARGILLA/CLAY FINISH

Impasto realizzato con terre colorate in pasta additate con cariche minerali a granulometria controllata e legante polimerico in dispersione acquosa, finitu a superficiale matt con protettivo impermeabilizzante. Anche in un singolo pezzo la struttura, la tonalità e la porosità non saranno mai completamente uniformi, piccole formazioni di pori e bande, minime differenze di colore o leggere fenditure fanno parte delle caratteristiche naturali del materiale e contribuiscono al pregio ed al valore individuale di ogni singolo pezzo.

A mix made with coloured earth in paste form, added to which are mineral fillers with controlled granulometry and polymer binder in aqueous dispersion, matt surface finish with protective waterproofing. Even in a single piece, the structure, colour tone and porosity will never be completely uniform; small formations of pores and bands, minor differences in colour and slight fissures are all part of the natural characteristics of the material and contribute to the quality and value of each individual piece.

COMPOSITI/COMPOSITES

CRISTALPLANT[®] /CRISTALPLANT[®]

Materiale brevettato composto per la maggior parte da cariche minerali di triidrossidi di alluminio di elevata purezza legati da resine di origine vegetale Biobased[®]: l'origine della resina è ricavata dal mais. È conosciuto per la bellezza simile alla pietra naturale dall'effetto soft touch, si presta a realizzare forme organiche senza giunti, antibatterico perché fotocatalitico.

A patented material mostly composed of mineral fillers of high-purity aluminium trihydroxide bound by Biobased[®] resins of plant origin: the resin is obtained from maize and is renowned for its beauty, which is similar to natural stone with a soft touch effect, lending itself to the creation of organic forms without joints; as it is photocatalytic, it is antibacterial.

LAMINATO/LAMINATE

Materiale costituito da un cuore a base di fogli di carta Kraft impregnata con resine termoindurenti e da uno strato decorativo superficiale composto da un foglio di carta stampata impregnato con resine aminoplastiche il tutto sottoposto all'azione combinata di alta pressione ed elevate temperature. Il prodotto che si ottiene è un materiale di eccellente qualità per le sue proprietà funzionali ed estetiche, facile da pulire, garantisce un'ottima resistenza alle macchie ed agli agenti chimici ed una discreta resistenza ai graffi.

A material consisting of a heart made of sheets of Kraft paper impregnated with thermosetting resins and a decorative surface layer composed of a sheet of printed paper impregnated with aminoplastic resins, all of which undergoes the combined action of high pressure and high temperatures. The product that is obtained is a material of excellent quality on account of its functional and aesthetic properties; it is easy to clean, guarantees excellent resistance to stains and chemical agents and fair resistance to scratching.

VETRORESINA/ FIBREGLASS

Materiale costituito da un tessuto in fibra di vetro che costituisce la parte strutturale e da resina poliesteri termoindurente che lega le varie fibre consentendo di realizzare manufatti con un'elevata resistenza meccanica, chimica ed alla corrosione, non necessita di una particolare manutenzione. È un materiale estremamente versatile potendo assumere qualsiasi forma dalle più morbide ed organiche a quelle più complesse ed estreme lasciando assoluta libertà alla creatività.

A material consisting of a glass fibre fabric that forms the structural part and thermosetting polyester resin, which bonds together the various fibres enabling products to be made with a high mechanical and chemical resistance and to corrosion; it does not require any particular maintenance. It is an extremely versatile material and is able to take on any form, from the softest and most organic to the more complex and extreme, leaving total freedom for creativity.

COMPOSITI/COMPOSITES

MDF LACCATO/LACQUERED MDF

“Medium-density fibreboard” materiale proveniente dalla lavorazione degli scarti del legno preferibilmente di conifera. Attraverso la macinazione degli scarti del legno si ottiene una pasta che additivata con resine viene pressata a temperatura elevata (fino a 210 °C) ottenendo un pannello compatto perfettamente liscio e privo di ondulazioni. La superficie del pannello di mdf grezzo viene “laccata” con una vernice poliesterica come base di fondo ed una vernice poliuretana superficiale per un risultato coprente e omogeneo in finitura opaca o lucida. Il laccato garantisce una buona resistenza alla luce ed alle macchie grazie al film protettivo assicurato dalla vernice poliuretana.

“Medium-density fibreboard”, a material made from processing waste wood, preferably conifers. By grinding the waste wood, a paste is obtained that, when resins are added, is pressed at very high temperatures (up to 210°C) obtaining a perfectly smooth and compact panel without undulations. The surface of the untreated MDF panel is “lacquered” with a polyester varnish as an undercoat and a surface polyurethane varnish for a covering and homogeneous result in matt or gloss finish. The lacquer guarantees good resistance to light and stains, thanks to the protective film guaranteed by the polyurethane varnish.

LEGNO MASSELLO/SOLID WOOD

Per legno massello si intende quella parte di legno ricavata dal tronco dell'albero, in particolare dal durame, la parte centrale di un tronco. Il legno massello "non ha difetti" e quelli che potrebbero sembrare dei difetti non sono altro che caratteristiche morfologiche del legno massello, ovvero, qualità che gli conferiscono il meritato titolo di "materiale unico ed irripetibile", parliamo di piccole crepe o fessure, nodi e variazioni di colore, caratteristiche della sua totale autenticità. Scegliere un materiale naturale comporta anche il saper accettare le piccole imperfezioni e la sensazione di vissuto che questo comporta. La superficie in legno ha una buona resistenza alla macchia ma una scarsa resistenza al graffio, trattandosi di un materiale naturale, viene influenzata dall'esposizione alla luce nel tempo.

Solid wood is understood to be that part of the wood that is obtained from the trunk of a tree, particularly from the duramen, the central part of a trunk. Solid wood "has no defects", indeed, what might appear to be defects are none other than the morphological characteristics of the solid wood, in other words, qualities that confer upon it the well deserved title of "unique, unrepeatable material", namely small cracks or fissures, knots and colour variations, characteristics of its total authenticity. Choosing a natural material also involves being able to accept the minor imperfections and the lived-in sensation that this involves. The wood surface has good resistance to staining but limited resistance to scratching and, being a natural material, is affected by exposure to light over time.

MOGANO/MAHOGANY

Il colore tipico è un rosso-bruno, le principali caratteristiche sono una elevata resistenza meccanica con una buona lavorabilità e stabilità. Il mogano è un legno pregiato e costoso da sempre utilizzato nell'ebanisteria di alta qualità e nei mobili di pregio.

Its typical colour is reddish-brown and its main characteristics are a high mechanical resistance with good machinability and stability. Mahogany is a precious and expensive wood, long used for high-quality cabinet-making and in valuable furniture.

FRASSINO EBANIZZATO/EBANISED ASH

Il colore tipico è un biondo chiaro con leggere sfumature tendenti al verde, le principali caratteristiche sono una buona resistenza meccanica e di lavorabilità con una buona attitudine alla verniciatura grazie alla marcata venatura e porosità. Il trattamento di "ebanizzazione" del frassino consiste nel tingere il legno con dei mordenti all'acqua di colore nero con una leggera sfumatura rossastra così da riprodurre il colore dell'ebano mantenendo il "poro aperto" del legno per evidenziare la caratteristica venatura.

Its typical colour is pale blond with light tones tending towards green, the main characteristics of which are good mechanical resistance and machinability with a good response to painting, thanks to its marked grain and porosity. The "ebanisation" treatment of ash consists of dyeing the wood with black water-based mordants with a slight reddish tone in order to reproduce the colour of ebony, maintaining the "open pores" of the wood to highlight the characteristic grain.

LEGNO MASSELLO/SOLID WOOD

NOCE CANALETTO/CANALETTO WALNUT

Conosciuto anche come noce americano, è ricco di tonalità e sfumature nel tono del marrone che variano dal bruno al moka sino ad arrivare al nero, la struttura può variare dal “fiamma o” al “rigato” e la combinazione del colore con la struttura crea un legno dalle trame eleganti e preziose.

Also known as American walnut, it is rich in the shades and tones of brown, which actually vary from mocha to darker brown, even to black; the structure may vary from “flamed” to “striped” and the combination of the colour with the structure creates a wood with elegant, precious patterns.

ROVERE FOSSILE/FOSSIL OAK

È un “rovere di palude” ottenuto dalla scoperta e dall'estrazione di antichi tronchi di rovere immersi per molti secoli sotto il letto di fiumi o laghi, a contatto continuo con l'acqua e la terra in un ambiente anaerobico. Sotto l'influenza dell'acqua, della sabbia, della terra, e con l'influenza della pressione da queste esercitata, si sono generate reazioni chimiche che attraverso la formazione di sali minerali hanno trasformato la struttura del legno rendendolo più simile alla pietra. Il colore può variare molto con tonalità che virano dal marrone-oro al nero intenso. È un materiale che viene dalla notte dei tempi, raro, naturale, molto prezioso, unico ed inimitabile.

This is a “swamp oak” obtained from the discovery and extraction of ancient oak trunks that have been immersed for many centuries in the beds of rivers or lakes, in continuous contact with the water and the earth in an anaerobic environment. Under the influence of water, sand and earth, and with the effect of the pressure exerted by these, chemical reactions have been produced that, through the formation of mineral salts, have transformed the structure of the wood, making it more similar to stone. The colour may vary considerably, with tones ranging from golden brown to intense black. It is a material that has come from the depths of time; it is rare, natural, very precious, unique and inimitable.

FAGGIO/BEECH

È il più diffuso legno utilizzato nell'arredamento, la sua durezza unita alla resistenza alla flessione, agli urti, alla compressione ed alla torsione ne fanno uno dei legni più interessanti dal punto di vista meccanico. Il colore è chiaro tendente al rosato, con tonalità che vanno dal bianco al bruno-rossastro con una punta di giallo.

This is the most widely used wood in furnishing; its hardness, together with its resistance to bending, impact, compression and torsion, make it one of the most interesting woods from the mechanical point-of-view. Its colour is pale, tending towards pink, with tones ranging from white to reddish-brown with a hint of yellow.

LEGNO MASSELLO/SOLID WOOD

ROVERE/OAK

E' la quercia uno degli alberi più presenti nei nostri boschi, di colore bruno chiaro che vira al giallo, tende a schiarire col tempo. E' un legno che si identifica facilmente in quanto ha una venatura caratteristica, lo troviamo sia "fiamma o" che "rigatino" a seconda del tipo di taglio.

Oak is one of the most common trees in our woods; pale brown in colour, turning towards yellow, it tends to become lighter in colour with time. It is a wood that is easily identified, as it has a characteristic grain. We find it both "flamed" and "striped", depending on the type of cut.

LEGNO TRANCIATO/*SLICED WOOD*

Per legno “tranciato” si intende il prodotto ricavato dal taglio del tronco dell’albero eseguito parallelamente al suo asse mediante l’utilizzo di “trance” o coltelli”. Si ottengono dei sottili fogli di legno dello spessore di circa 1mm. che riportano fedelmente tutte le caratteristiche di colore e struttura del legno massello. Ci sono varie modalità di tranciatura (all’ italiana, alla francese, sul largo) in funzione di come preliminarmente viene sezionato il tronco. I sottili fogli di legno di una larghezza variabile dai 10 ai 20 cm. vengono “stirati” per renderli perfettamente piani, rifilati sul lato lungo e “giuntati” tra loro a “fil ” o a “colla” per ottenere un unico grande foglio di legno delle dimensioni volute. Sarà l’esperienza dell’artigiano che nella “composizione” dei fogli riuscirà a costruire un insieme esteticamente equilibrato ed armonico.

“Sliced” wood is understood to be the product obtained from cutting the tree trunk parallel to its axis using “shears” or knives”. Thin sheets of wood are obtained with a thickness of around 1mm that faithfully bear all the characteristics of colour and structure of the solid wood. There are various methods of slicing (Italian-style, French-style, broad cut) depending on how the trunk is sectioned at the preliminarily stage. The thin wooden sheets, with a width varying between 10 and 20 cm, are “stretched” to make them perfectly flat trimmed along the long side and “sewn together” with “thread” or “glue” to obtain a single large wooden sheet of the desired dimensions. It is thanks to their own experience that in the “composition” of the sheets the artisans succeed in creating an aesthetically balanced and harmonious whole.

MOGANO/*MAHOGANY*

Il colore tipico è un rosso-bruno.

Its typical colour is reddish-brown.

NOCE CANALETTO/*CANALETTO WALNUT*

Il colore ha sfumature nel tono del marrone che variano dal bruno al moka sino ad arrivare al nero.

Its colour has shades of brown, varying from mocha to darker brown, even to black.

LEGNO TRANCIATO/*SLICED WOOD*

ROVERE/*OAK*

Di colore bruno chiaro che vira al giallo.

Pale brown in colour, turning towards yellow.

OLMO/*ELM*

Il colore varia dal beige chiaro sino al bruno cupo cioccolato, addirittura al rossastro.

Its colour ranges from pale beige to dark chocolate brown, even to a reddish tone.

WENGE'/*WENGE*

Di colore bruno scuro variegato da strisce nerastre.

Dark brown in colour with contrasting blackish stripes.

LEGNO TRANCIATO/*SLICED WOOD*

LEGNO PRECOMPOSTO MULTILAMINARE / *MULTILAMINAR PREFORMED WOOD*

Il tranciato "multilaminare" è costituito da molte lamine sottili anche di diverse specie legnose che, dopo essere state colorate singolarmente, vengono impaginate e assemblate così da ottenere dei veri legni masselli dai quali vengono poi ricavati i tranciati finali. Possiamo avere tranciati con struttura "fiamma a" ottenuti mediante taglio del tronco eseguito tangenzialmente agli anelli del tronco o tranciati "rigati" con venature verticali ottenuto da una parte di tronco tagliato perpendicolarmente agli anelli.

"Multilaminar" sliced wood consists of a number of thin sheets, even of different wood species, which, after being coloured individually, are paginated and assemble so as to obtain real solid woods, from which the final slices are obtained. We can have slices with a "flamed" structure, obtained by cutting the trunk tangentially to the rings of the trunk, or sliced "striped" with vertical grains obtained from a part of the trunk cut perpendicular to the rings.

CALEIDOLEGNO FIAMMATO BIANCO E NERO / *FLAMED WHITE BLACK CALEIDOLEGNO*

"Multilaminare" con struttura fiamma a, colore di base bianco con venature nere.

"Multilaminar" with flamed structure, basic colour white with black graining.

CALEIDOLEGNO RIGATO MARRONE / *STRIPED BROWN CALEIDOLEGNO*

"Multilaminare" con struttura rigata, colore di base beige chiaro e venature verticali marrone scuro.

"Multilaminar" with striped structure, basic colour pale beige and vertical dark brown graining.

MATERIALI LAPIDEI/STONE MATERIALS

Da sempre la pietra naturale esercita un grande fascino grazie all'impatto estetico ed alla bellezza della materia stessa. Espressione di un legame con la nostra terra e la nostra cultura, la pietra naturale racchiude in sé milioni di anni di evoluzione geologica e si racconta coniugando storia, sapienza artigianale e moderna tecnologia. Le pietre naturali vantano caratteristiche estetiche inimitabili date dall'intensa espressività della texture, ricca di toni e sfumature, ciò rende ogni lastra unica e irripetibile e, a volte, anche due pezzi della stessa lastra non sono uguali. Eventuali inclusioni e differenze di venatura, colorazione e simmetrie non possono essere previste a priori e sono quindi da considerarsi caratteristica intrinseca del materiale, espressione della sua unicità e prova inconfutabile che si tratti di una pietra veramente naturale.

Natural stone has always been considered especially charming, thanks to the aesthetic impact and beauty of the material itself. The expression of a bond with our land and our culture, natural stone contains millions of years of geological evolution and tells its story combining history, hand-crafting expertise and modern technology. Natural stones boast inimitable aesthetic characteristics, thanks to the intense expressiveness of the textures, rich in tones and shades, making every slab unique and unrepeatably; at times, even two pieces of the same slab are not identical. Any inclusions and differences in veins, coloration and symmetries cannot be predicted and are therefore to be considered as intrinsic characteristics of the material, the expression of its uniqueness and irrefutable proof that it is a truly natural stone./

MARMO BIANCO DI CARRARA/WHITE CARRARA MARBLE

È il marmo per antonomasia: un marmo puro e compatto, esteticamente possiamo definirlo come “un fresco manto nevoso percorso da leggere venature grigie”. Il nostro Bianco di Carrara proviene da una delle cave più rinomate situata sulle propaggini meridionali del Monte Altissimo nelle Alpi Apuane dove Michelangelo Buonarroti nel 1517 veniva ad approvvigionarsi dei marmi per realizzare i suoi capolavori.

This is the quintessential marble: a pure and compact marble, aesthetically we could define it as “a fresh mantle of snow with light grey veins crossing it”. Our Carrara White comes from one of the most famous quarries, located on the southern slopes of Monte Altissimo in the Apuan Alps, where in 1517 Michelangelo Buonarroti came to collect his marble supplies to create his masterpieces.

MARMO MARQUIÑA/MARQUIÑA MARBLE

Il marmo Nero Marquiña è un materiale dal colore nero intenso a fondo molto compatto attraversato da venature irregolari di colore bianco o grigio chiaro, più o meno marcate con andamento diagonale, particolare che conferisce al marmo Nero Marquiña un aspetto originale e mai scontato.

Nero Marquiña marble is a material with an intense black colour with a very compact base crossed by irregular pale white or grey coloured veins, more or less marked, running diagonally, a detail that gives Nero Marquiña marble an original and never predictable appearance.

MATERIALI LAPIDEI/*STONE MATERIALS*

QUARZITE/*QUARTZITE*

La Quarzite Grigia proviene dall' India, è un materiale dal colore grigio che può presentare qualche puntino più scuro, il suo tono è complessivamente chiaro ed omogeneo.della pietra.

Grey quartzite comes from India; it is a material that is grey in colour that can have a few darker dots, overall its tone is pale and homogeneous.

MARMO RICOMPOSTO/*RECOMPOSED MARBLE*

Pietra ricostruita composta da polvere di alabastro e resina realizzata seguendo un processo produttivo artigianale. Ogni manufatto prodotto è completamente rifinito a mano e le irrilevanti imperfezioni che si possono riscontrare sono la testimonianza di un lavoro fatto a mano.

A reconstructed stone composed of alabaster powder and resin created through an artisan production process. Each product made is completely hand-finished and the insignificant imperfections that may occur are evidence of the manual work involved.

VETRI/GLASS

Nobile e prezioso il vetro è un materiale di forte espressività, all'apparenza fragile ma in realtà resistente e in grado di trasmettere sensazioni di inaspettata e stupefacente leggerezza.

Tutti i nostri vetri subiscono il trattamento di tempra che riscalda il vetro ad altissime temperature e lo raffredda repentinamente. Il vetro temprato, in accordo alla normativa europea, assume così una conformazione interna che lo rende cinque volte più resistente del vetro normale e, in caso di rottura totale, si frantuma in minuscoli pezzi non taglienti. Per dare ai nostri vetri colorati opachi o lucidi il colore desiderato è stata messa a punto una vernice che mantiene inalterato il tono di colore applicato ed assicura un'aderenza eccellente sul vetro.

Fine and precious, glass is a highly expressive material with a fragile appearance, but in reality it is tough and capable of conveying feelings of surprising, unexpected lightness. All our glass undergoes tempering treatment, whereby it is heated at high temperatures and cooled rapidly. In accordance with European regulations, tempered glass therefore takes on an internal conformation that makes it five times more resistant than normal glass and, in the event of total breakage, it is shattered into tiny, non-sharp pieces. To give our coloured opaque polished glasses the desired colour, a varnish has been perfected that keeps the colour tone applied unchanged and ensures an excellent adherence to the glass.

VETRO TRASPARENTE/TRANSPARENT

Vetro float chiaro temperato.

Clear tempered float glass.

VETRO LACCATO OPACO/LACQUERED OPAQUE GLASS

Vetro float chiaro temperato con un trattamento di acidatura superficiale per realizzare un "effetto pesca" incredibilmente piacevole al tatto. Verniciatura sul lato inferiore con speciali vernici per garantire una perfetta aderenza al vetro.

Clear tempered float glass with a surface etching treatment to create a "peach effect" that is incredibly pleasant to the touch. Painted on the lower side with special varnishes to guarantee a perfect adherence to the glass.

VETRI/GLASS

VETRO LACCATO LUCIDO/*POLISHED LACQUERED GLASS*

Vetro float chia o temperato. Verniciatura sul lato inferiore con speciali vernici per garantire una perfetta aderenza al vetro.

Clear tempered float glass. Painted on the lower side with special varnishes to guarantee a perfect adherence to the glass.

SPECCHIO/*MIRROR*

Vetro float chia o con deposto un sottile strato di argento ricoperto da una vernice protettiva.

Clear float glass with a thin layer of silver applied, covered by a protective varnish.

VETRO SOFFIATO/*BLOWN GLASS*

Il procedimento per dare una forma al vetro è la soffiatura: libera o a stampo. La tecnica di soffiatura può essere variata utilizzando stampi di ferro, bronzo o legno bagnato. In queste forme viene soffiata la massa vitrea, ripetutamente scaldata, che si modella dilatandosi e sagomandosi. La soffiatura del vetro è un'arte che non ha età.

The procedure for shaping glass is blowing: free or moulded. The blowing technique can be varied by using moulds made of iron, bronze or wet wood. Into these forms the heated glass mass is blown and shaped by expanding. Glassblowing is an ageless art.

METALLI/METALS

I metalli si trovano in natura come minerali nelle rocce e vengono estratti attraverso procedimenti di fusione o elettrolisi. Quando parliamo di metallo facciamo riferimento a lamiere e tubi di acciaio o alluminio sottoposti a trattamenti finali di finitura per garantire un'adeguata protezione superficiale ed ottenere effetti estetici che impreziosiscono con modalità distintive le varie collezioni.

Metals are found in nature as minerals in rocks and are extracted through founding procedures or electrolysis. When we talk about metal we are referring to steel or aluminium plates and pipes that undergo finishing treatments to guarantee adequate surface protection and obtain aesthetic effects that embellish the various collections using distinctive methods.

ACCIAIO VERNICIATO A POLVERE POLIESTERE/STEEL PAINTED WITH POLYESTER POWDER

Acciaio sottoposto a verniciatura in forno industriale nella quale la fase finale di cottura avviene a temperature elevate (circa 170°). La verniciatura a polvere poliestere presenta eccellenti caratteristiche di resistenza ai raggi UV, ottime caratteristiche meccaniche, buona resistenza agli agenti chimici (detersivi, detergenti, olii, acidi leggeri, e alcali diluiti) ed agli agenti atmosferici.

Steel undergoing painting in an industrial furnace in which the final firing phase happens at high temperatures (around 170°). The polyester powder paint has excellent characteristics of resistance to UV rays, excellent mechanical characteristics, good resistance to chemical agents (cleansers, detergents, oils, light acids and diluted alkali) and to atmospheric agents.

ACCIAIO CROMATO/CHROME-PLATED

Acciaio sottoposto ad un trattamento superficiale di cromatura galvanica per ottenere un particolare perfettamente lucido e riflettente mediante immersione del pezzo in una vasca contenente una soluzione elettrolitica di cromo trivalente "ecologico".

Steel undergoing a galvanic chrome-plating surface treatment to obtain a perfectly polished and reflective finish by immersing the piece in a tank containing an "ecological" trivalent chromium electrolytic solution.

METALLI/METALS

ACCIAIO INOX LUCIDO/POLISHED STAINLESS STEEL

Acciaio inossidabile particolarmente resistente alla corrosione sottoposto ad una serie di operazioni di levigatura con grane via via meno aggressive. Quando la superficie è perfettamente liscia, uniforme e priva di graffi con spazzole in cotone il pezzo viene lucidato a specchio.

Stainless steel particularly resistant to corrosion undergoing a series of polishing operations with gradually less aggressive grits. When the surface is perfectly smooth, uniform and without scratches, the piece is mirror polished using cotton brushes.

ALLUMINIO VERNICIATO A POLVERE POLIESTERE/ALUMINIUM PAINTED WITH POLYESTER POWDER

Alluminio sottoposto a verniciatura in forno industriale nella quale la fase finale di cottura avviene a temperature elevate (circa 170°). La verniciatura a polvere poliestere presenta eccellenti caratteristiche di resistenza ai raggi UV, ottime caratteristiche meccaniche, buona resistenza agli agenti chimici (detersivi, detergenti, olii, acidi leggeri, e alcali diluiti) ed agli agenti atmosferici.

Aluminium undergoing painting in an industrial furnace in which the final firing phase happens at high temperatures (around 170°). The polyester powder paint has excellent characteristics of resistance to UV rays, excellent mechanical characteristics, good resistance to chemical agents (cleansers, detergents, oils, light acids and diluted alkali) and to atmospheric agents.

ALLUMINIO ANODIZZATO/ANODISED ALUMINIUM

Alluminio sottoposto ad un processo elettrochimico di "anodizzazione" per ottenere esclusivi effetti cromatici tramite l'aggiunta di pigmenti colorati con una superficie morbida e vellutata particolarmente piacevole al tatto.

Aluminium undergoing an electrochemical process of "anodisation" to obtain exclusive chromatic effects through the addition of coloured pigments with a soft, velvety surface that is particularly pleasant to the touch.

MATERIE PLASTICHE/*PLASTIC MATERIALS*

Il termine "plastica" deriva dalla parola greca "plastikos", che significa adatto per essere modellato riferendosi alla malleabilità o plasticità del materiale durante la produzione quindi può essere fuso, stampato o estruso in una varietà infinita di forme. La "plastica" è un materiale altamente versatile lasciandosi "modificare" in qualsiasi combinazione di proprietà per adattarsi alle molteplici esigenze estetiche o meccaniche.

The term "plastic" derives from the Greek word "plastikos", which means suitable for moulding, referring to the malleability or plasticity of the material during production; therefore, it can be cast, pressed or extruded in an endless variety of forms. "Plastic" is a highly versatile material allowing itself to be "modified" into any combination of properties to suit multiple aesthetic or mechanical requirements.

POLIPROPILENE/*POLYPROPYLENE*

Polimero termoplastico (comunemente indicato come PP) caratterizzato da un elevato carico di rottura in particolare viene utilizzato nello stampaggio ad iniezione

A thermoplastic polymer (commonly indicated as PP) characterised by a high tensile strength, it is used in particular in injection moulding.

POLIETILENE/*POLYETHYLENE*

Resina termoplastica (comunemente indicata come PE) la più semplice dei polimeri sintetici e la più comune fra le materie plastiche molto versatile ed economico in particolare viene utilizzato nello stampaggio rotazionale.

Polietilene verniciato opaco soft touch ottenuto grazie all'impiego di vernici acriliche opache all'acqua che conferiscono al prodotto una particolare resistenza all'usura, alla luce e agli agenti atmosferici oltre ad ottenere un aspetto estetico, e al tatto, morbido e "setoso" che si combina perfettamente con la proposta colore nei toni della pelle

A thermoplastic resin (commonly indicated as PE), the simplest of the synthetic polymers and the most common among plastic materials; very versatile and inexpensive, it is used in particular in rotational moulding.

Soft touch matt varnished polyethylene thanks to the use of water-based matt acrylic paints that give the product a particular resistance to the use, to the light and to atmospheric agents as well as an aesthetic appearance, a soft and "silky" touch that combines perfectly with the new colors in human skin tones

MATERIE PLASTICHE/*PLASTIC MATERIALS*

POLICARBONATO/*POLYCARBONATE*

Polimero termoplastico con una eccezionale qualità di trasparenza alla radiazione luminosa visibile e di resistenza all'impatto, in particolare viene utilizzato nello stampaggio ad iniezione.

A thermoplastic polymer with an exceptional quality of transparency to visible light radiation and resistance to impact, it is used in particular in injection moulding.

SAN/*SAN*

Copolimero con buone proprietà meccaniche, elevata rigidità e di resistenza ai solventi, in particolare viene utilizzato nello stampaggio ad iniezione.

A copolymer with good mechanical properties, high rigidity and resistance to solvents, it is used in particular in injection moulding.

ABS METALLIZZATO/*METALLIC ABS*

Polimero termoplastico (comunemente indicato come ABS) con caratteristiche meccaniche di resistenza all'impatto e durezza, in particolare viene utilizzato nello stampaggio ad iniezione o estrusione. La superficie in ABS viene "nobilitata" con un trattamento superficiale di metallizzazione ovvero la deposizione di un sottile film di metallo in condizione di vuoto per ottenere particolari aspetti estetici dall'aspetto brillante, riflettente e metallico in una svariata gamma di colorazioni.







A thermoplastic polymer (commonly indicated as ABS) with mechanical characteristics of resistance to impact and toughness, it is used in particular in injection moulding or extrusion. The ABS surface is "ennobled" with a metallic surface treatment, namely by applying a thin film of metal under vacuum conditions to obtain particular aesthetic appearances, shiny, mirror and metallic, in a diverse range of colorations.

MATERIE PLASTICHE/*PLASTIC MATERIALS*

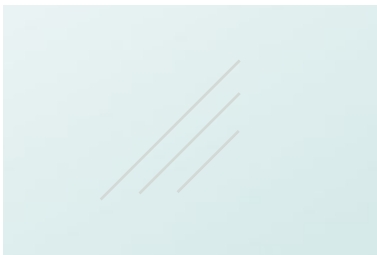
POLIURETANO RIGIDO/*RIGID POLYURETHANE*

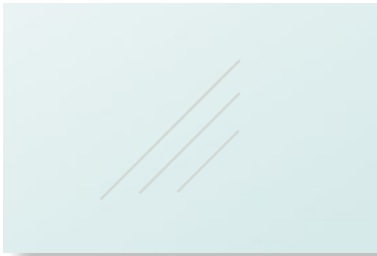
Polimero termoindurente, è il risultato della reazione chimica di due sostanze base il poliolo e l'isocianato che miscelate fra loro creano una schiuma che solidifica a risulta una superficie compat a con un'elevata resistenza meccanica, viene utilizzato nello stampaggio "per colata".

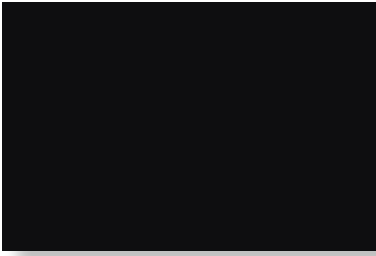
A thermosetting polymer, it is the result of the chemical reaction of two basic substances, polyol and isocyanate, which are mixed together, creating a foam that, when solidified, forms a compact surface with a high mechanical resistance; it is used in "cast" moulding.

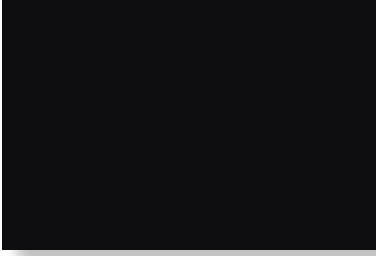
ANAPO - Piano/ Top	ANAPO - Struttura in acciaio verniciato/ <i>Painted steel structure</i>	Codice materiale <i>Material code</i>
 <p data-bbox="234 526 393 574">Vetro trasparente <i>Transparent glass</i></p>	 <p data-bbox="939 526 1315 598">Acciaio verniciato Nero Ral. 9005 opaco <i>Painted steel matt Black Ral 9005</i> codice campione/sample code: VER091O3</p>	<p data-bbox="1545 253 1685 342">361 Vetro/Acciaio <i>Glass/Steel</i></p>
 <p data-bbox="234 989 393 1037">Vetro trasparente <i>Transparent glass</i></p>	 <p data-bbox="939 989 1299 1061">Acciaio verniciato Oro lucido metallizzato <i>Painted steel glossy metallic Gold color</i> codice campione/sample code: MET112L1</p>	<p data-bbox="1545 722 1685 812">361 Vetro/Acciaio <i>Glass/Steel</i></p>
 <p data-bbox="234 1463 615 1535">Marmo Carrara Bianco levigato <i>White polished Carrara marble</i> codice campione/sample code: MAR002O1</p>	 <p data-bbox="939 1463 1315 1535">Acciaio verniciato Nero Ral. 9005 opaco <i>Painted steel matt Black Ral 9005</i> codice campione/sample code: VER091O3</p>	<p data-bbox="1534 1194 1692 1284">363 Marmo/Acciaio <i>Marble/Steel</i></p>
 <p data-bbox="234 1937 615 2009">MDF finitu a Castagno <i>Chestnut finish MDF</i> codice campione/sample code: LEICA154L1</p>	 <p data-bbox="939 1937 1315 2009">Acciaio verniciato Nero Ral. 9005 opaco <i>Painted steel matt Black Ral 9005</i> codice campione/sample code: VER091O3</p>	<p data-bbox="1488 1666 1736 1755">362 Impiall.Castagno /Acciaio <i>Veneered chestnut/Steel</i></p>

APP - Struttura e piano in polipropilene/
Polypropylene structure and top

Codice materiale
Material code



Polipropilene Bianco Ral 9016
Polypropylene White Ral 9016
codice campione/sample code: PLA002O2



Polipropilene Nero Antracite Ral 7016
Polypropylene Anthracite Black Ral 7016
codice campione/sample code: PLA091O5

379
Polipropilene
Polypropylene

Codice materiale
Material code

BO

Codice materiale
Material code



Polipropilene Senape Dic C146
Polypropylene Mustard Dic C146
codice/code: PLA02001

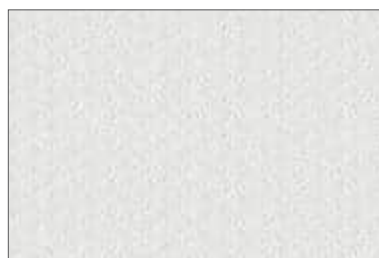

Polipropilene Bianco Ral 9016
Polypropylene White Ral 9016
codice/code: PLA00202



Polipropilene Cipria Dic C104
Polypropylene Carnation Dic C104
codice/code: PLA01701

379
Polipropilene
Polypropylene



Polipropilene Grigio Pantone Cool Gray 3U
Polypropylene Grey Pantone Cool Grey 3U
codice/code: PLA04403

CARMINA

Codice materiale
Material code



Alluminio-Acciaio verniciati Nude
Painted Aluminim-Steel Nude color
codice/code: VER15201



Alluminio-Acciaio verniciati Sabbia
Painted Aluminim-Steel Sand color
codice/code: VER01101

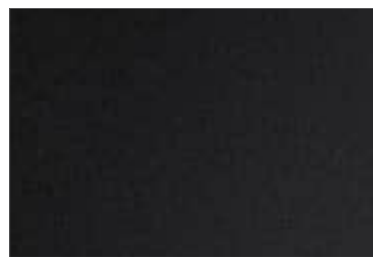

Alluminio-Acciaio verniciati Nero
Painted Aluminim-Steel Black
codice/code: VER09105

432
Alluminio verniciato-
Acciaio verniciato
*Painted Aluminim-
Painted steel*

CLOVER

Codice materiale
Material code

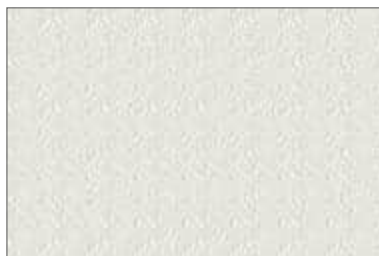

Polietilene Bianco Ral 9010
White Ral 9010 polyethylene
codice/code: PLA002O4



Polietilene Nero antracite Ral 7016
Anthracite Black Ral 9010 polyethylene
codice/code: PLA091O5

278
Polietilene
Polyethylene

COSTES/PRATFALL - Scocca/
Shell

COSTES/PRATFALL - Cuscino/
Cushion

COSTES/PRATFALL - Struttura/
Structure

Codice materiale
Material code



Impiallacciato Mogano
Mahogany veneer
codice/code: LEIMO154O1

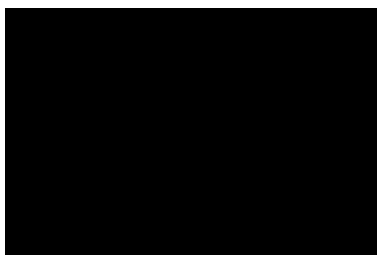

Pelle nera
Black leather



Acciaio verniciato Nero Ral.9005 opaco
Painted steel matt Black Ral 9005
codice/code: VER091O3

088
Impiallacciato mogano-
Pelle-Acciaio verniciato/
*Mahogany veneer-
Leather-Painted steel*



Impiallacciato Rovere Ebanizzato
Ebonized oak veneer
codice/code: LEIMO096O1

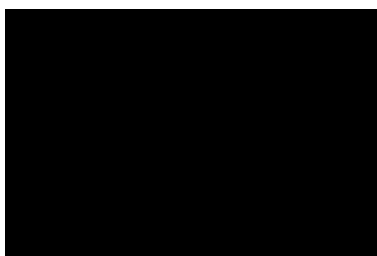

Pelle nera
Black leather



Acciaio verniciato Nero Ral.9005 opaco
Painted steel matt Black Ral 9005
codice/code: VER091O3

088
Impiallacciato mogano-
Pelle-Acciaio verniciato/
*Mahogany veneer-
Leather-Painted steel*

COSTES/PRATFALL - Scocca/
Shell

COSTES/PRATFALL - Cuscino/
Cushion

COSTES/PRATFALL - Struttura/
Structure

Codice materiale
Material code



Impiallacciato ebano
Ebony veneered
codice/code: LEIWE154O1

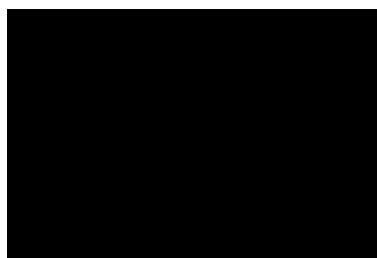

Pelle nera
Black leather



Acciaio verniciato Nero Ral. 9005 opaco
Painted steel matt Black Ral 9005
codice/code: VER091O3

090
Impiallacciato wengé-
Pelle-Acciaio verniciato/
Wenge veneer-Leather-
Painted steel





SOLO PER SEDIA COSTES/
ONLY FOR COSTES CHAIR

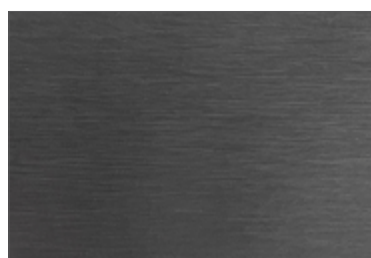



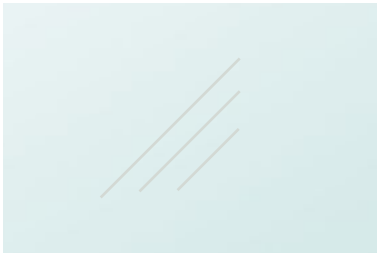

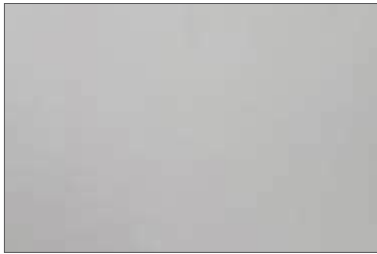
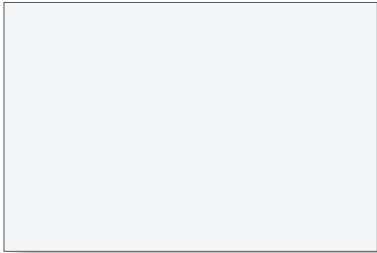
Per la scelta dei tessuti o pelli vedere tabella a pag.1123



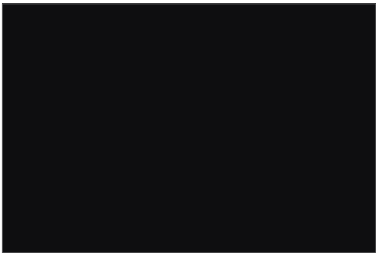



For the choice of fabrics or leathers see table on page 1123







Acciaio verniciato Titanio
Painted steel Titanium
codice/code: VER117O1

CUGINO/CUGINETTO - Piano/ <i>Top</i>	CUGINO/CUGINETTO - Struttura/ <i>Structure</i>	Codice materiale <i>Material code</i>
 <p data-bbox="234 526 393 574">Vetro trasparente <i>Transparent glass</i></p>	 <p data-bbox="937 519 1226 591">Acciaio verniciato Nero antracite <i>Anthracite Black painted steel</i> codice/code: VER05701</p>	<p data-bbox="1494 251 1730 334">361 Vetro-Acciaio verniciato <i>Glass-Painted steel</i></p>
DIDYMOS - Piano/ <i>Top</i>	DIDYMOS - Struttura/ <i>Structure</i>	Codice materiale <i>Material code</i>
 <p data-bbox="234 1513 505 1585">Marmo Carrara Bianco lucido <i>White polished Carrara marble</i> codice/code: MAR002L2</p>	 <p data-bbox="937 1513 1153 1585">Cristalplant Bianco <i>White Cristalplant</i> codice/code: RES00201</p>	<p data-bbox="1494 1255 1694 1399">341 Marmo Carrara- Cristalplant <i>Carrara marble- Cristalplant</i></p>
 <p data-bbox="234 1978 475 2050">Laminato Bianco laccato <i>White lacquered Laminate</i> codice/code: LATUN00201</p>	 <p data-bbox="937 1967 1153 2039">Cristalplant Bianco <i>White Cristalplant</i> codice/code: RES00201</p>	<p data-bbox="1494 1716 1721 1799">343 Laminato-Cristalplant <i>Laminate-Cristalplant</i></p>

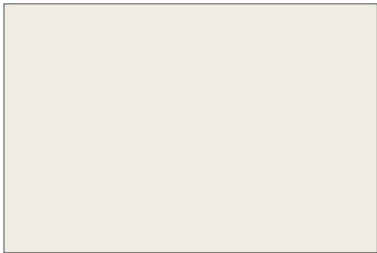
DIDYMOS - Piano/ <i>Top</i>	DIDYMOS - Struttura/ <i>Structure</i>	Codice materiale <i>Material code</i>
 <p data-bbox="234 526 516 598">Marmo Marquina Nero lucido <i>Black polished Marquina marble</i> codice/code: MAR091L1</p>	 <p data-bbox="939 526 1221 598">Cristalplant Nero Ral. 9005 opaco <i>Matt Black Ral 9005 Cristalplant</i> codice/code: VER091O3</p>	<p data-bbox="1525 246 1703 388">342 Marmo Marquina- Cristalplant <i>Marquina marble- Cristalplant</i></p>
 <p data-bbox="234 991 469 1063">Laminato Nero laccato <i>Black lacquered Laminate</i> codice/code: LATUN091O1</p>	 <p data-bbox="939 991 1221 1063">Cristalplant Nero Ral. 9005 opaco <i>Matt Black Ral 9005 Cristalplant</i> codice/code: VER091O3</p>	<p data-bbox="1506 711 1723 788">343 Laminato-Cristalplant <i>Laminate-Cristalplant</i></p>
EASEL - Piano/ <i>Top</i>	EASEL - Struttura/ <i>Structure</i>	Codice materiale <i>Material code</i>
 <p data-bbox="234 1511 502 1583">Impiallacciato Noce Canaletto <i>Canaletto Walnut veneer</i> codice/code: LEMNOF9601</p>	 <p data-bbox="939 1511 1184 1583">Legno di Noce Canaletto <i>Canaletto Walnut wood</i> codice/code: LEMNOF9601</p>	<p data-bbox="1488 1253 1736 1334">354 Impiallacciato Noce-Noce <i>Walnut veneer-Walnut</i></p>
 <p data-bbox="234 1978 396 2026">Vetro trasparente <i>Transparent glass</i></p>	 <p data-bbox="939 1967 1184 2039">Legno di Noce Canaletto <i>Canaletto Walnut wood</i> codice/code: LEMNOF9601</p>	<p data-bbox="1543 1683 1681 1764">355 Vetro-Noce <i>Glass-Walnut</i></p>

EASEL - Piano/ <i>Top</i>	EASEL - Struttura/ <i>Structure</i>	Codice materiale <i>Material code</i>
 <p data-bbox="234 526 505 598">Marmo Carrara Bianco lucido <i>White polished Carrara marble</i> codice/code: MAR002L2</p>	 <p data-bbox="937 526 1183 598">Legno Noce Canaletto <i>Canaletto Walnut wood</i> codice/code: LEMNOF96O1</p>	<p data-bbox="1499 248 1730 329">359 Marmo Carrara-Noce <i>Carrara marble-Walnut</i></p>
 <p data-bbox="234 989 393 1039">Vetro trasparente <i>Transparent glass</i></p>	 <p data-bbox="937 989 1193 1061">Legno di Frassino Ebanizzato <i>Ebonized Ash wood</i> codice/code: LEMFR096O1</p>	<p data-bbox="1539 709 1688 790">356 Vetro-Frassino <i>Glass-Ash</i></p>
 <p data-bbox="234 1439 518 1511">Marmo Marquina Nero lucido <i>Black polished Marquina marble</i> codice/code: MAR091L1</p>	 <p data-bbox="937 1432 1193 1504">Legno di Frassino Ebanizzato <i>Ebonized Ash wood</i> codice/code: LEMFR096O1</p>	<p data-bbox="1525 1164 1703 1301">360 Marmo Marquina- Frassino <i>Marquina marble- Ash</i></p>

ERCOLE & AFRODITE - Contenitore/ <i>Container</i>	ERCOLE & AFRODITE - Pedana/ <i>Base</i>	Codice materiale <i>Material code</i>
		371 MDF laccato- Impiallacciato rovere <i>Lacquered MDF- Oak veneered</i>
<p>MDF laccato Bianco Ral 9010 opaco <i>Matt White Ral 9010 lacquered MDF</i> codice/code: VER00206</p>	<p>Legno di Rovere sbiancato <i>Bleached Oak wood</i> codice/code: LEIROF9701</p>	
		371 MDF laccato- Impiallacciato rovere <i>Lacquered MDF- Oak veneered</i>
<p>MDF laccato Nero Ral 9005 opaco <i>Matt Black Ral 9005 lacquered MDF</i> codice/code: VER09103</p>	<p>Legno di Rovere tinto grigio <i>Grey stained Oak wood</i> codice/code: LEIRO04501</p>	









FENIX - Struttura/
Structure

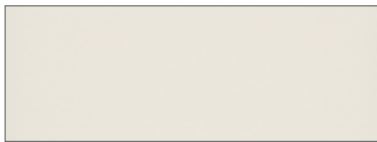

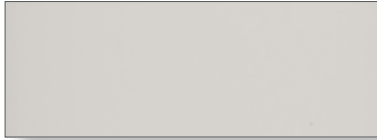
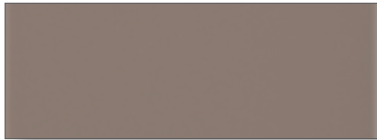















Acciaio verniciato peltro bronzato
Bronze pewter painted steel
codice/code: VERD4701

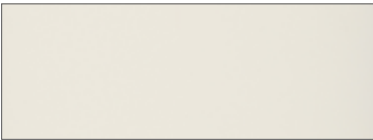

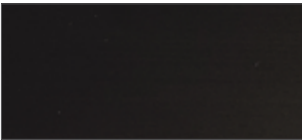
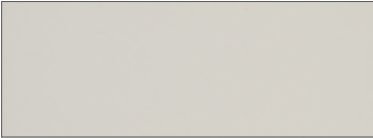

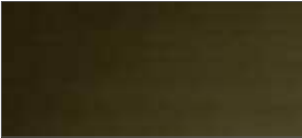
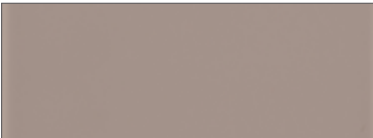



FENIX - Tessuti-Pelli/
Fabrics-Leather



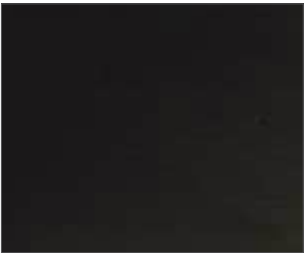

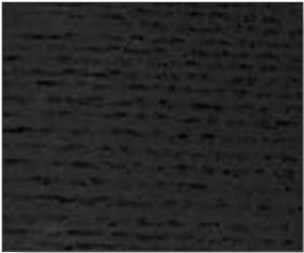

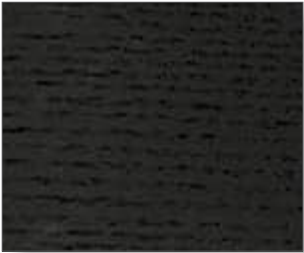

Per la scelta dei tessuti o pelli vedere tabella a pag.1124
For the choice of fabrics or leathers see table on page 1124

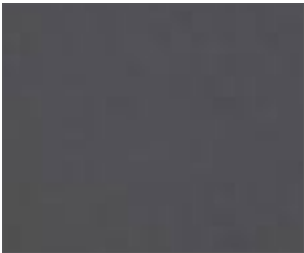

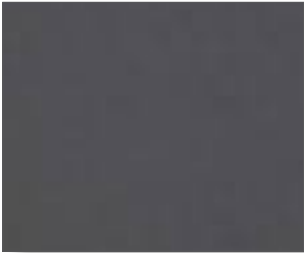

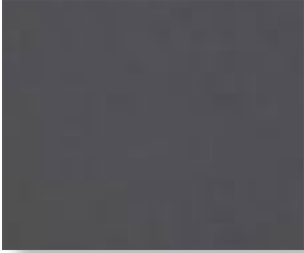

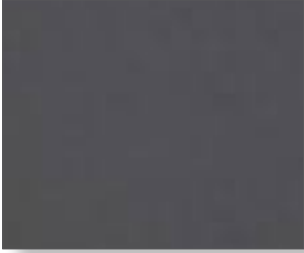

FOURDROPS - Piano/ <i>Top</i>	FOUDROPS - Struttura/ <i>Structure</i>	Codice materiale <i>Material code</i>
 <p>Vetro laccato Bianco puro lucido <i>Glossy pure white lacquered glass</i> codice/code: VET002L2</p>	 <p>Legno di Frassino ebanizzato <i>Ebonized Ash wood</i> codice/code: LEMFR09601</p>	<p>356 Vetro-Frassino <i>Glass-Ash</i></p>
 <p>Vetro laccato Bianco nuvola lucido <i>Glossy cloud white lacquered glass</i> codice/code: VETD49L2</p>	<p>MANCA CODICE</p>	<p>MANCA CODICE</p>
 <p>Vetro laccato Sabbia lucido <i>Glossy Sand lacquered glass</i> codice/code: VET011L2</p>	 <p>Impiallacciato Olmo <i>Elm veneered</i> codice/code: LEMOL15401</p>	<p>MANCA CODICE</p>
 <p>Vetro laccato Rosso lucido <i>Glossy Red lacquered glass</i> codice/code: VET039L2</p>	<p>MANCA CODICE</p>	<p>MANCA CODICE</p>
 <p>Vetro laccato Macchia med.lucida <i>Glossy Med.stain lacquered glass</i> codice/code: VETD50L2</p>	<p>MANCA CODICE</p>	<p>MANCA CODICE</p>
 <p>Vetro laccato Caffé lucido (Mocaccino) <i>Glossy coffee lacquered glass (Mocaccino)</i> codice/code: VET086L2</p>	<p>MANCA CODICE</p>	<p>MANCA CODICE</p>
 <p>Vetro laccato Nero lavagna lucido <i>Glossy black chalkboard lacquered glass</i> codice/code: VET091L2</p>	<p>MANCA CODICE</p>	<p>MANCA CODICE</p>

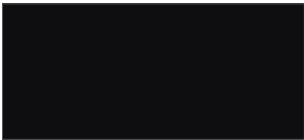
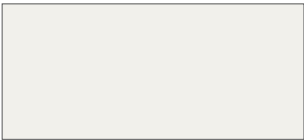
FOURDROPS - Piano/ Top	FOUDROPS - Struttura/Profil Structure/Profile	Codice materiale Material code
 <p data-bbox="234 526 516 598">Marmo Marquina Nero lucido <i>Black polished Marquina marble</i> codice/code: MAR091L1</p>	 <p data-bbox="939 526 1193 598">Legno di Frassino ebanizzato <i>Ebonized Ash wood</i> codice/code: LEMFR096O1</p>	<p data-bbox="1494 253 1736 334">360 Marmo Marquina-Frassino <i>Marquina marble-Ash</i></p>
 <p data-bbox="234 984 505 1057">Marmo Carrara Bianco lucido <i>White polished Carrara marble</i> codice/code: MAR002L2</p>	 <p data-bbox="939 978 1193 1050">Legno di Frassino ebanizzato <i>Ebonized Ash wood</i> codice/code: LEMFR096O1</p>	<p data-bbox="1494 711 1736 792">364 Marmo Carrara-Frassino <i>Carrara marble-Ash</i></p>
 <p data-bbox="234 1443 471 1515">Impiallacciato Olmo <i>Elm veneered</i> codice/code: LEMOL154O1</p>	 <p data-bbox="939 1437 1175 1509">Legno di Olmo <i>Elm wood</i> codice/code: LEMOL154O1</p>	<p data-bbox="1494 1166 1736 1247">422 Impiallacciato Olmo-Olmo <i>Elm veneered-Elm</i></p>
 <p data-bbox="234 1902 538 1974">Impiallacciato Frassino ebanizzato <i>Ebonized Ash veneered</i> codice/code: XXXXXXX</p>	 <p data-bbox="939 1895 1193 1967">Legno di Frassino ebanizzato <i>Ebonized Ash wood</i> codice/code: LEMFR096O1</p>	<p data-bbox="1494 1624 1736 1705">423 Impiall. Frassino-Frassino <i>Ash veneered-Ash</i></p>

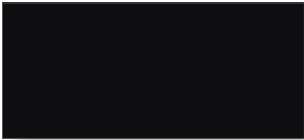
FRANÇOIS - Piano/ Top	FRANÇOIS - Struttura/Profil Structure/Profile	Codice materiale Material code
 <p>Vetro laccato Bianco puro opaco <i>Matt pure white lacquered glass</i> codice/code: VET00201</p>	 <p>Legno di Frassino tinto rovere naturale <i>Natural oak stained ash wood</i> codice/code: LEIRO15401</p>  <p>Alluminio anodizzato Testa di moro <i>Dark brown anodized Aluminum</i> codice/code: MET08501</p>	<p>349 Vetro acidato-Frassino- Alluminio anodizzato <i>Etched glass-Ash- Anodized aluminium</i></p>
 <p>Vetro laccato Bianco nuvola opaco <i>Matt cloud white lacquered glass</i> codice/code: VETD4901</p>	 <p>Legno di Frassino tinto rovere ebanizzato <i>Ebonized oak stained ash wood</i> codice/code: LEMRO09601</p>  <p>Alluminio anodizzato Bronzo <i>Bronze anodized Aluminum</i> codice/code: MET12201</p>	
 <p>Vetro laccato Sabbia opaco <i>Matt Sand lacquered glass</i> codice/code: VET01101</p>		
 <p>Vetro laccato Rosso opaco <i>Matt Red lacquered glass</i> codice/code: VET03901</p>		
 <p>Vetro laccato Macchia med.opaca <i>Matt Med.stain lacquered glass</i> codice/code: VETD5001</p>		
 <p>Vetro laccato Caffé opaco (Mocaccino) <i>Matt coffee lacquered glass (Mocaccino)</i> codice/code: VET08601</p>		
 <p>Vetro laccato Nero lavagna opaco <i>Matt black chalkboard lacquered glass</i> codice/code: VET09101</p>		

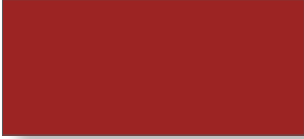
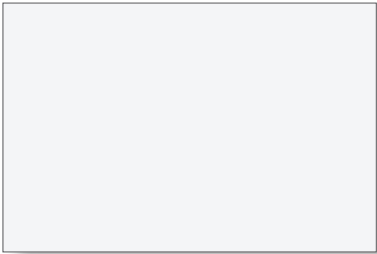
FRANÇOIS - Piano/ Top	FRANÇOIS - Struttura/ Structure		Codice materiale Material code
 <p data-bbox="234 532 562 607">Legno di Frassino tinto rovere naturale <i>Natural oak stained ash wood</i> codice/code: LEIRO154O1</p>	 <p data-bbox="798 532 1126 607">Legno di Frassino tinto rovere naturale <i>Natural oak stained ash wood</i> codice/code: LEIRO154O1</p>	 <p data-bbox="1152 532 1456 607">Alluminio anodizzato Testa di moro <i>Dark brown anodized Aluminum</i> codice/code: MET085O1</p>	<p data-bbox="1512 246 1718 388">350 Rovere-Frassino- Alluminio anodizzato <i>Oak-Ash- Anodized aluminium</i></p>
 <p data-bbox="234 991 584 1065">Legno di Frassino tinto rovere ebanizzato <i>Ebonized oak stained ash wood</i> codice/code: LEMRO096O1</p>	 <p data-bbox="798 991 1130 1065">Legno di Frassino tinto rovere ebanizzato <i>Ebonized oak stained ash wood</i> codice/code: LEMRO096O1</p>	 <p data-bbox="1152 991 1401 1065">Alluminio anodizzato Bronzo <i>Bronze anodized Aluminum</i> codice/code: MET122O1</p>	<p data-bbox="1512 705 1718 847">350 Rovere-Frassino- Alluminio anodizzato <i>Oak-Ash- Anodized aluminium</i></p>
 <p data-bbox="234 1447 505 1522">Marmo Carrara Bianco lucido <i>White polished Carrara marble</i> codice/code: MAR002L2</p>	 <p data-bbox="798 1447 1130 1522">Legno di Frassino tinto rovere ebanizzato <i>Ebonized oak stained ash wood</i> codice/code: LEMRO096O1</p>	 <p data-bbox="1152 1447 1454 1522">Alluminio anodizzato Testa di moro <i>Dark brown anodized Aluminum</i> codice/code: MET085O1</p>	<p data-bbox="1494 1170 1736 1312">351 Marmo Carrara-Frassino- Alluminio anodizzato <i>Carrara marble-Ash- Anodized aluminium</i></p>

FRATE/FRATELLO - Piano/ Top	FRATE/FRATELLO - Struttura/ Structure		Codice materiale Material code
 <p data-bbox="234 532 393 580">Vetro trasparente <i>Transparent glass</i></p>	 <p data-bbox="798 532 1088 607">Acciaio verniciato Nero Antracite <i>Anthracite Black painted steel</i> codice/code: VER05701</p>	 <p data-bbox="1152 532 1385 607">Legno di Faggio Naturale <i>Natural Beech wood</i> codice/code: LEMFA15401</p>	<p data-bbox="1490 246 1736 388">345 Vetro-Acciaio verniciato- Faggio <i>Glass-Painted steel- Beech</i></p>
 <p data-bbox="234 989 393 1037">Vetro trasparente <i>Transparent glass</i></p>	 <p data-bbox="798 989 1088 1063">Acciaio verniciato Nero Antracite <i>Anthracite Black painted steel</i> codice/code: VER05701</p>	 <p data-bbox="1152 989 1448 1063">Legno di Noce Canaletto Naturale <i>Natural Canaletto Walnut wood</i> codice/code: LEMNOF9601</p>	<p data-bbox="1490 705 1736 847">346 Vetro-Acciaio verniciato- Noce <i>Glass-Painted steel- Walnut</i></p>
 <p data-bbox="234 1443 393 1491">Vetro trasparente <i>Transparent glass</i></p>	 <p data-bbox="798 1443 1088 1517">Acciaio verniciato Nero Antracite <i>Anthracite Black painted steel</i> codice/code: VER05701</p>	 <p data-bbox="1152 1443 1445 1517">Legno di Rovere fossile Naturale <i>Natural fossil Oak wood</i> codice/code: LEIRF15401</p>	<p data-bbox="1490 1164 1736 1306">347 Vetro-Acciaio verniciato- Rovere fossile <i>Glass-Painted steel- Fossil oak</i></p>
 <p data-bbox="234 1902 393 1950">Vetro trasparente <i>Transparent glass</i></p>	 <p data-bbox="798 1902 1088 1976">Acciaio verniciato Nero Antracite <i>Anthracite Black painted steel</i> codice/code: VER05701</p>	 <p data-bbox="1152 1902 1394 1976">Legno di Rovere ebanizzato <i>Ebonized Oak wood</i> codice/code: LEMRO09601</p>	<p data-bbox="1490 1622 1736 1764">348 Vetro-Acciaio verniciato- Rovere <i>Glass-Painted steel- Oak</i></p>

GAZELLE - Piano/ Top	GAZELLE - Struttura/ Structure		Codice materiale Material code
			<p>366 Finitura cemento- Acciaio verniciato/ Cement finish- Painted steel</p>
<p>Finitura Cemento Cement finish codice/code: ARG05701</p>	<p>Acciaio verniciato Nero Ral 9005 opaco Matt black Ral 9005 painted Steel codice/code: VER09103</p>	<p>Acciaio verniciato Bianco Ral 9016 opaco Matt White Ral 9016 painted steel codice/code: VER00203</p>	
			
	<p>Acciaio verniciato Rosso Ral 3001 Red Ral 3001 painted Steel codice/code: VER03902</p>		
			<p>367 Finitura argilla- Acciaio verniciato/ Clay finish- Painted steel</p>
<p>Finitura Argilla Champagne Champagne color Clay finish codice/code: ARGD4601</p>	<p>Acciaio verniciato Nero Ral 9005 opaco Matt black Ral 9005 painted Steel codice/code: VER09103</p>	<p>Acciaio verniciato Bianco Ral 9016 opaco Matt White Ral 9016 painted steel codice/code: VER00203</p>	
			
	<p>Acciaio verniciato Rosso Ral 3001 Red Ral 3001 painted Steel codice/code: VER03902</p>		
			<p>368 Laminato- Acciaio verniciato/ Laminate- Painted steel</p>
<p>Laminato Bianco White Laminate codice/code: LATUN00201</p>	<p>Acciaio verniciato Nero Ral 9005 opaco Matt black Ral 9005 painted Steel codice/code: VER09103</p>	<p>Acciaio verniciato Bianco Ral 9016 opaco Matt White Ral 9016 painted steel codice/code: VER00203</p>	
			
	<p>Acciaio verniciato Rosso Ral 3001 Red Ral 3001 painted Steel codice/code: VER03902</p>		

HANAHANA

Codice materiale
Material code

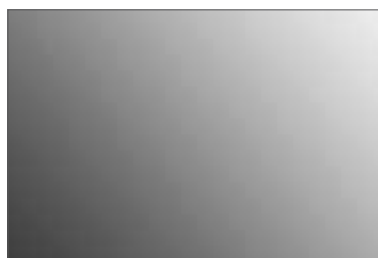

Acciaio inox lucidato a specchio
Mirror polished painted stainless steel
codice/code: META95L1

431
Acciaio inox lucidato
Painted stainless steel

HIDALGO

Codice materiale
Material code



Laminato marrone/
Brown Laminate
codice/code: LEPRIF98L1

472
Multistrato impiallacciato
Tabu rigato/
Acciaio inossidabile
*Striped Tabu veneer
multilayer/
Stainless steel*



Laminato rigato bianco e nero
White and black striped Laminate
codice/code: LEPF1155O1

473
Multistrato impiallacciato
Tabu fiamma o/Acciaio
verniciato
*Flamed Tabu veneer mul-
tilayer/ Painted steel*



Poliuretano-Alluminio/*Polyurethane-Aluminum*
Sabbia Pantone warm grey 4C lucido
Glossy Sand Pantone Warm Gray 4C

474
Multistrato laccato
sfumato/
Acciaio verniciato
*Multi-layer lacquered/
Painted steel*

KISSI KISSI

Codice materiale
Material code

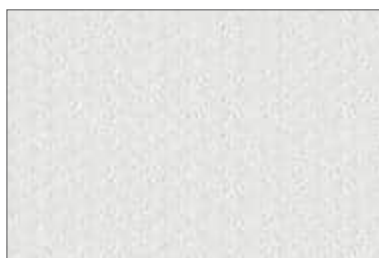

Polietilene Bianco Ral 9016
White Ral 9016 Polyethylene
codice/code: PLA002O2

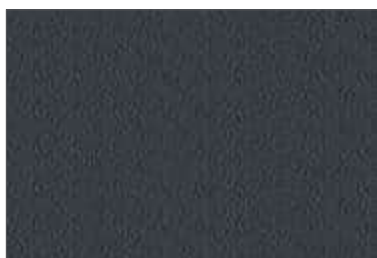

Polietilene Nero antracite Ral 7016
Anthracite black Ral 7016 Polyethylene
codice/code: PLA091O5

278
Polietilene
Polyethylene

KOISHI

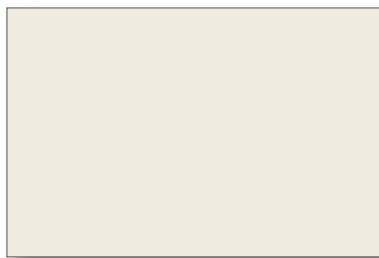

Fibra di vetro verniciata Bianco Ral 9010 lucido
Painted Glass fibre White Ral 9010 glossy
codice/code: VER002L5

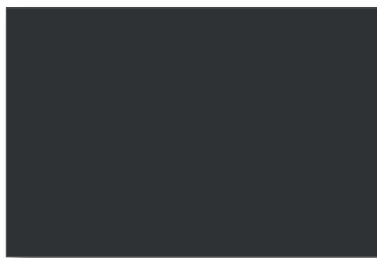

Fibra di vetro verniciata Grigio antr. Ral 7021 lucido
Painted Glass fibre Anth. gray Ral 7021 glossy
codice/code: VER057L2

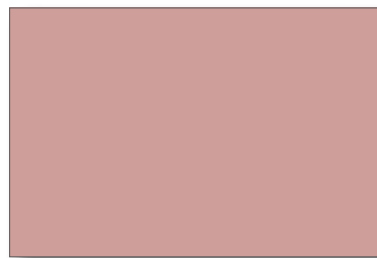

Fibra di vetro verniciata Rosa Ral 030 7020 lucido
Painted Glass fibre Pink Ral 030 7020 glossy

369
Fibra di vetro verniciata
Painted glass fibre

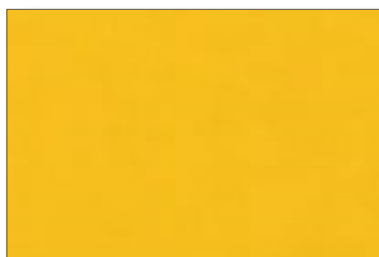

Fibra di vetro verniciata Gialla Ral 1032 lucido
Painted Glass fibre Yellow Ral 1032 glossy



Fibra di vetro verniciata Rosso
Painted Glass fibre Red



Legno di Frassino naturale
Natural ash wood
codice/code: LEMFR154O1



Legno di Frassino ebanizzato
Ebonized ash wood
codice/code: LEMFR096O1

Per la scelta dei tessuti o pelli vedere tabella a pag.1125
For the choice of fabrics or leathers see table on page 1125

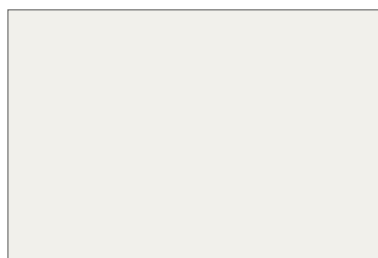

Poliuretano-Alluminio/*Polyurethane-Aluminum*
Bianco Ral 9016
White Ral 9016
codice/code: VER002L2

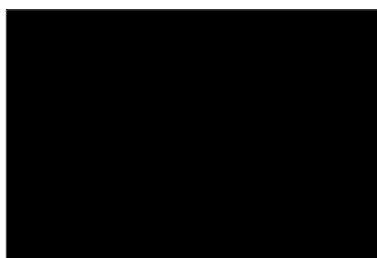

Poliuretano-Alluminio/*Polyurethane-Aluminum*
Nero Dic P-1000 lucido
Glossy Black Dic P-1000
codice/code: VER091L2



Poliuretano-Alluminio/*Polyurethane-Aluminum*
Rosso lucido
Glossy Red
codice/code: VER039L1



Poliuretano-Alluminio/*Polyurethane-Aluminum*
Blu oltremare Pantone 654C lucido
Glossy ultramarine Blue Pantone 654C
codice/code: VER076L1



Poliuretano-Alluminio/*Polyurethane-Aluminum*
Arancio Pantone 1505C lucido
Glossy orange Pantone 1505C
codice/code: VER033L2



Poliuretano-Alluminio/*Polyurethane-Aluminum*
Verde RAL D2 1204040 lucido
Glossy Green RAL D2 1204040
codice/code: VER063L1



Poliuretano-Alluminio/*Polyurethane-Aluminum*
Azzurro Pantone 5405C lucido
Glossy light Blue Pantone 5405C
codice/code: VER060L1



Poliuretano-Alluminio/*Polyurethane-Aluminum*
Vinaccia Pantone 221C lucido
Glossy Burgundy Pantone 221C
codice/code: VER032L1

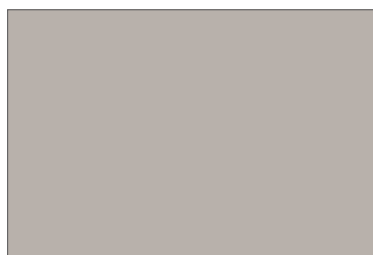

Poliuretano-Alluminio/*Polyurethane-Aluminum*
Sabbia Pantone warm grey 4C lucido
Glossy Sand Pantone Warm Gray 4C
codice/code: VER044L1



Poliuretano-Alluminio/*Polyurethane-Aluminum*
Tortora Pantone warm grey 10C lucido
Glossy Pantone Warm Gray 10C
codice/code: VER044L2

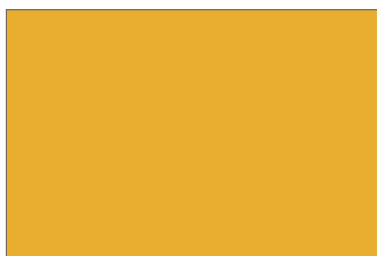



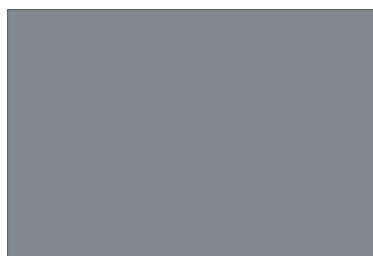

Poliuretano-Alluminio/*Polyurethane-Aluminum*
Zafferano Pantone 130C lucido
Glossy Saffron Pantone 130C
codice/code: VER023L1

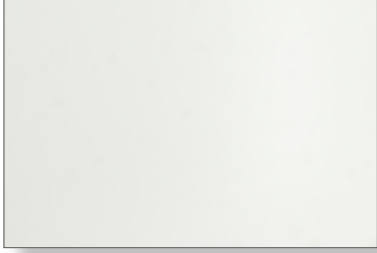

Poliuretano-Alluminio/*Polyurethane-Aluminum*
Carta da zucchero Pantone 430C lucido
Glossy Dark Blue Pantone 430C
codice/code: VER123L1

085
Poliuretano rigido verniciato-
Alluminio verniciato
*Painted rigid Polyurethane-
Painted aluminum*

LAGO' - Scocca/ <i>Shell</i>	LAGO' - Gambe/ <i>Legs</i>	Codice materiale <i>Material code</i>
		086 Cuoio-Alluminio anodizzato <i>Leather-Anodized aluminum</i>
		
		
		

Cuoio tortora
Taupe leather

Alluminio Anodizzato
Anodized aluminum

Cuoio marrone
Brown leather

Cuoio bianco
White leather

Cuoio nero
Black leather













Alluminio verniciato Nero Ral 9005 opaco
Painted Aluminum Matt Black Ral 9005
codice/code: VER091O3

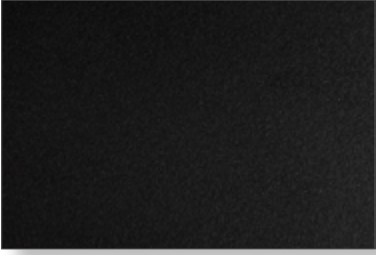

Alluminio verniciato argento
Painted Aluminum silver
codice/code: VER043O1

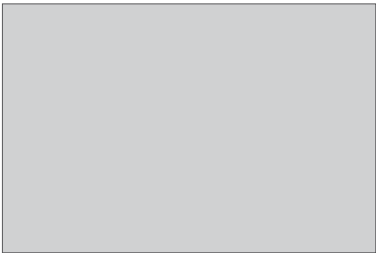
Per la scelta dei tessuti o pelli vedere tabella a pag.1126
For the choice of fabrics or leathers see table on page 1126

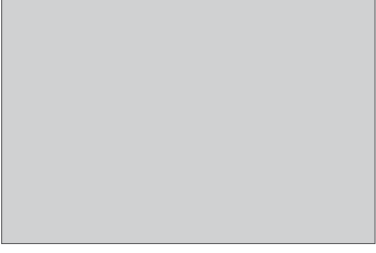
LORD YI - Piano/ <i>Top</i>	LORD YI - Struttura/ <i>Structure</i>	Codice materiale <i>Material code</i>
 <p data-bbox="234 526 447 598">SAN Avorio <i>SAN Ivory</i> codice/code: PLA004L1</p>	 <p data-bbox="939 526 1281 598">Alluminio verniciato Grigio alluminio <i>Painted Aluminum Grey aluminum color</i> codice/code: VERO44O3</p>	<p data-bbox="1494 275 1736 355">388 SAN-Alluminio verniciato <i>SAN-Painted aluminum</i></p>
 <p data-bbox="234 984 511 1057">Marmo Carrara bianco levigato <i>Smooth white Carrara marble</i> codice/code: MAR002O1</p>	 <p data-bbox="939 984 1281 1057">Alluminio verniciato Grigio alluminio <i>Painted Aluminum Grey aluminum color</i> codice/code: VERO44O3</p>	<p data-bbox="1494 736 1736 875">389 Marmo Carrara-Alluminio verniciato <i>Carrara marble-Painted aluminum</i></p>
 <p data-bbox="234 1445 516 1517">Marmo Marquina Nero lucido <i>Black polished Marquina marble</i> codice/code: MAR091L1</p>	 <p data-bbox="939 1439 1286 1511">Alluminio verniciato Grigio antracite <i>Painted Aluminum Anthracite Grey color</i> codice/code: VERO57O1</p>	<p data-bbox="1521 1194 1712 1334">390 Marmo Marquina- Alluminio verniciato <i>Marquina marble- Painted aluminum</i></p>

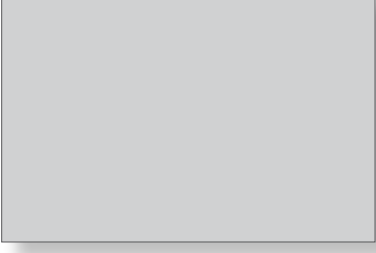
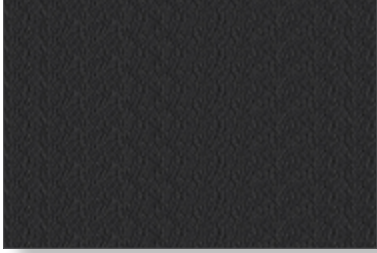
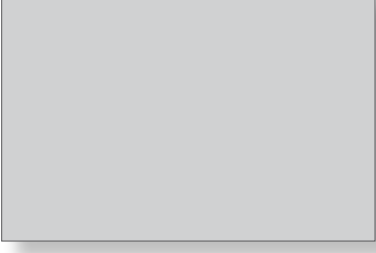
LORD YO - Scocca/ <i>Shell</i>	LORD YO - Struttura/ <i>Structure</i>	Codice materiale <i>Material code</i>
 <p data-bbox="234 526 493 598">Polipropilene Bianco Ral 9016 <i>White Ral 9016 Polypropylene</i> codice/code: PLA00202</p>	 <p data-bbox="939 526 1030 574">Alluminio <i>Aluminum</i></p>	<p data-bbox="1497 275 1729 358">380 Polipropilene-Alluminio <i>Polypropylene-Aluminum</i></p>
 <p data-bbox="234 984 538 1057">Polipropilene Cipria Dic -C104 <i>Carnation Dic -C104 Polypropylene</i> codice/code: PLA01701</p>	 <p data-bbox="939 978 1030 1026">Alluminio <i>Aluminum</i></p>	<p data-bbox="1497 733 1729 816">380 Polipropilene-Alluminio <i>Polypropylene-Aluminum</i></p>
 <p data-bbox="234 1443 633 1515">Polipropilene Grigio chiaro Pantone Warm Grey 4U <i>Light Gray Pantone Warm Gray 4U Polypropylene</i> codice/code: PLA04501</p>	 <p data-bbox="939 1437 1030 1485">Alluminio <i>Aluminum</i></p>	<p data-bbox="1497 1192 1729 1275">380 Polipropilene-Alluminio <i>Polypropylene-Aluminum</i></p>
 <p data-bbox="234 1895 493 1967">Polipropilene Nero Ral 9004 <i>Black Ral 9004 Polypropylene</i> codice/code: PLA09103</p>	 <p data-bbox="939 1895 1030 1943">Alluminio <i>Aluminum</i></p>	<p data-bbox="1497 1651 1729 1734">380 Polipropilene-Alluminio <i>Polypropylene-Aluminum</i></p>



Alluminio lucidato
Polished Aluminum
codice/code: MET114L1





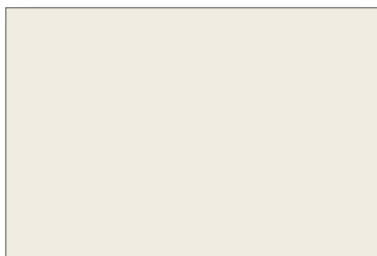





Alluminio verniciato Nero Ral 9005 opaco
Painted Aluminum Matt Black Ral 9005
codice/code: VER091O3



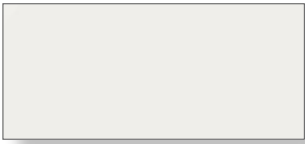

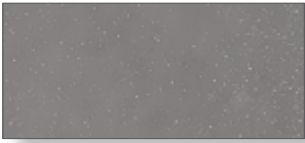

Alluminio verniciato Bianco Ral 9010 opaco
Painted Aluminum Matt White RAL 9010
codice/code: VER002O6

Per la scelta dei tessuti o pelli vedere tabella a pag.1127
For the choice of fabrics or leathers see table on page 1127

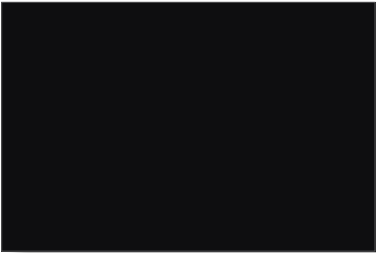
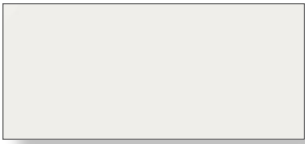
LOVE - Struttura/ <i>Structure</i>	LOVE - Maniglie/ <i>Handles</i>		Codice materiale <i>Material code</i>
 <p data-bbox="234 526 482 598">MDF laccato Bianco traffic <i>Traffic white lacquered MDF</i> codice/code: VER003M7</p>	 <p data-bbox="798 412 1088 484">MDF laccato Grigio luce <i>Light grey lacquered MDF</i> codice/ code: VER045M4</p>	 <p data-bbox="1150 412 1408 484">MDF laccato Grigio grafi e <i>Graphite grey lacquered MDF</i> codice/code: VER050M5</p>	<p data-bbox="1536 275 1692 355">123 MDF laccato <i>Lacquered MDF</i></p>
 <p data-bbox="234 984 482 1057">MDF laccato Nero traffic <i>Traffic black lacquered MDF</i> codice/code: VER091M7</p>	 <p data-bbox="798 871 1026 943">MDF laccato Rosso traffic <i>Traffic red lacquered MDF</i> codice/code: VER039M5</p>	 <p data-bbox="1150 871 1385 943">MDF laccato Giallo flu <i>Fluo yellow lacquered MDF</i> codice/code: VER022M2</p>	
 <p data-bbox="234 1439 469 1511">MDF laccato Rosso rubino <i>Ruby red lacquered MDF</i> codice/code: VER039M4</p>	 <p data-bbox="798 1330 1015 1402">MDF laccato Rosa flu <i>Fluo pink lacquered MDF</i> codice/code: VERF57L1</p>		

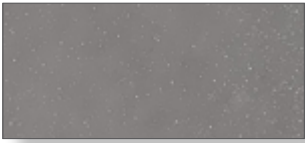
MERIDIANA - Scocca/ <i>Shell</i>	MERIDIANA - Struttura/ <i>Structure</i>	Codice materiale <i>Material code</i>
<p>Per la scelta dell pelle vedere tabella a pag.1127 <i>For the choice of leather see table on page 1127</i></p>	 <p>Legno di Frassino naturale <i>Natural ash wood</i> codice/code: LEMFR154O1</p>  <p>Legno di Frassino tinto carbone <i>Charcoal-stained ash wood</i> codice/code: LEMFR088O1</p>	<p>079 Pelle-Frassino <i>Leather-Ash</i></p>
 <p>Bianco <i>White</i> codice/code: PLA002L1</p>  <p>Nero <i>Black</i> codice/code: PLA091L1</p>  <p>Trasparente <i>Transparent</i> codice/code: PLA001L1</p>  <p>Fumè <i>Smoked grey</i> codice/code: PLA056L1</p>	 <p>Legno di Frassino naturale <i>Natural ash wood</i> codice/code: LEMFR154O1</p>  <p>Legno di Frassino tinto carbone <i>Charcoal-stained ash wood</i> codice/code: LEMFR088O1</p>	<p>156 Policarbonato-Frassino <i>Polycarbonate-Ash</i></p>

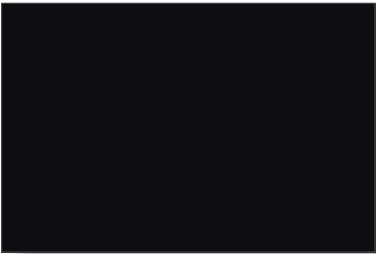
MERIDIANA - Scocca/ <i>Shell</i>	MERIDIANA - Struttura/ <i>Structure</i>	Codice materiale <i>Material code</i>
<p>Per la scelta della pelle vedere tabella a pag.1127 <i>For the choice of leather see table on page 1127</i></p>	 <p>Acciaio cromato <i>Chromed steel</i></p>  <p>Acciaio verniciato Nero Ral 9005 opaco <i>Painted Steel Matt Black Ral 9005</i> codice/code: VER091O3</p>	<p>184 Pelle-Acciaio cromato <i>Leather-Chromed steel</i></p> <p>148 Pelle-Acciaio verniciato <i>Leather-Painted steel</i></p>
 <p>Policarbonato Bianco <i>White Polycarbonate</i> codice/code: PLA002L1</p>  <p>Policarbonato Nero <i>Black Polycarbonate</i> codice/code: PLA091L1</p>  <p>Policarbonato Trasparente <i>Transparent Polycarbonate</i> codice/code: PLA001L1</p>  <p>Policarbonato Fumè <i>Smoked grey Polycarbonate</i> codice/code: PLA056L1</p>	 <p>Acciaio cromato <i>Chromed steel</i></p>  <p>Acciaio verniciato Nero Ral 9005 opaco <i>Painted Steel Matt Black Ral 9005</i> codice/code: VER091O3</p>	<p>157 Policarbonato-Acciaio cromato <i>Polycarbonate-Chromed steel</i></p> <p>158 Policarbonato-Acciaio verniciato <i>Polycarbonate-Painted steel</i></p>

MILLEPIEDI

Codice materiale
Material code



Bianco RAL 9010
White RAL 9010
codice/code: LEMFR00201



Rosso
Red
codice/code: LEMFR03901



Nero
Black
codice/code: LEMFR09101

471
Frassino tinto
Stained Ash

MISS LACY

Codice materiale
Material code

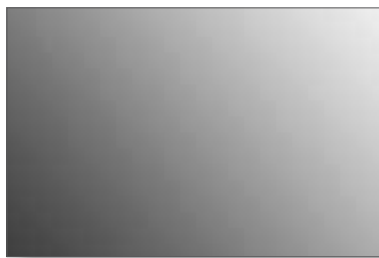

Acciaio inox lucidato
Polished stainless Steel
codice/code: META95L1

A95
Acciaio inox lucidato
Polished stainless steel



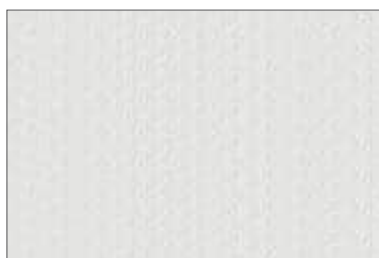

MODESTY VEILED

Codice materiale
Material code

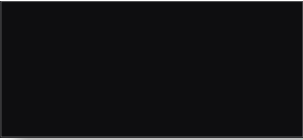

Polietilene Bianco Ral 9003
White Ral 9003 Polyethylene
codice/code: PLA002O5

278
Polietilene
Polyethylene

MOON - Scocca/ <i>Shell</i>	MOON - Struttura/ <i>Structure</i>	MOON - Tessuti-Pelli/ <i>Fabrics-Leather</i>
 <p>Poliuretano rigido Ecrù <i>Ecrù rigid Polyurethane</i> codice/code: VER009O1</p>  <p>Poliuretano rigido Nero Ral 9005 lucido <i>Glossy Black Ral 9005 rigid Polyurethane</i> codice/code: VER091L4</p>  <p>Poliuretano rigido Mattone <i>Brick rigid Polyurethane</i> codice/code: VER037O1</p>	 <p>Acciaio cromato <i>Chromed steel</i></p>	<p>Per la scelta dei tessuti o pelli vedere tabella a pag.1128 <i>For the choice of fabrics or leathers see table on page 1128</i></p>
<p>MT</p>		<p>Codice materiale <i>Material code</i></p>
 <p>Polietilene Bianco sabbia <i>White sand Polyethylene</i> codice/code: PLAD48O1</p>	<p>I colori Rosso e Nero, che si trovano all'interno del prodotto MT, si ottengono solamente nel processo di lavorazione e quindi non sono campionabili. <i>The Red and Black colors, which are found inside the MT product, are obtained only in the manufacturing process and therefore cannot be sampled.</i></p>	<p>278 Polietilene <i>Polyethylene</i></p>

NEMO

Codice materiale
Material code

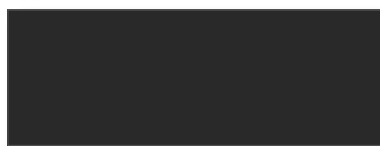

Polietilene Nero laccato Ral 9017
Black lacquered Ral 9017 Polyethylene
codice/code: VER091L6

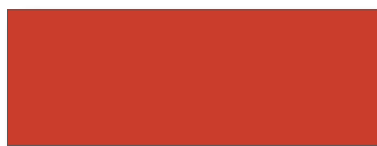

Polietilene Rosso laccato Pantone 485C
Red lacquered Pantone 485C Polyethylene
codice/code: VER039L3

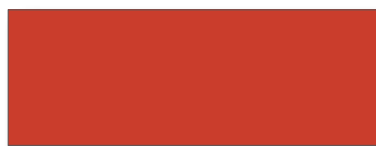

Polietilene Rosso laccato Pantone 485C
Red lacquered Pantone 485C Polyethylene
codice/code: VER039L3

279
Polietilene verniciato
lucido
*Gloss painted
polyethylene*



Nemo Custom

477
Polietilene verniciato
opaco soft touch
*Soft touch matt
varnished polyethylene*

NEMO - NEMO MINIATURA

Codice materiale
Material code

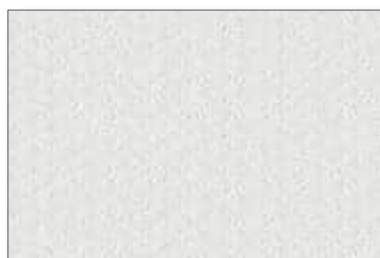

Polietilene Bianco Ral 9016
White Ral 9016 Polyethylene
codice/code: PLA002O2



Polietilene Nero Ral 9011
Black Ral 9011 Polyethylene
codice/code: PLA091O2



Polietilene Grigio Pantone 7537U
Grey Pantone 7537U Polyethylene
codice/code: PLA044O1

278
Polietilene
Polyethylene



Polietilene Rosso Pantone 1797C
Red Pantone 1797C Polyethylene
codice/code: PLA039O1

NEMO MINIATURA

Codice materiale
Material code

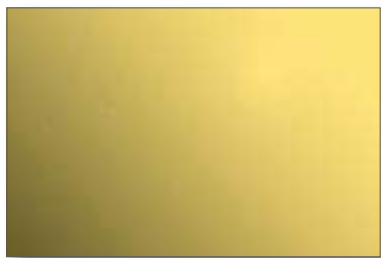

ABS metallizzato Oro
Gold color ABS metallized
codice/code: MET112L1



ABS metallizzato Argento
Silver color ABS metallized
codice/code: MET043L1

376
ABS metallizzato
ABS metallized

PING I, II

Codice materiale
Material code



Alluminio
Aluminum
codice/code: MET114L1

114
Alluminio
Aluminum

PIP-e

Codice materiale
Material code



Polipropilene Cipria Dic C104
Carnation Dic C104 Polypropylene
codice/code: PLA01701



Polipropilene Grigio lavanda DIC-C285
Lavender Grey DIC-C285 Polypropylene
codice/code: PLA05501



Polipropilene Bianco RAL 9001
White Ral 9001 Polypropylene
codice/code: PLA00203

379
Polipropilene
Polypropylene



Polipropilene Grigio scuro Pantone 446U
Dark Grey Pantone 446U Polypropylene
codice/code: PLA05001

PLIE', GRAND PLIE', PIAFFE'

Codice materiale
Material code



Polietilene Bianco Ral 9016
White Ral 9016 Polyethylene
codice/code: PLA00202

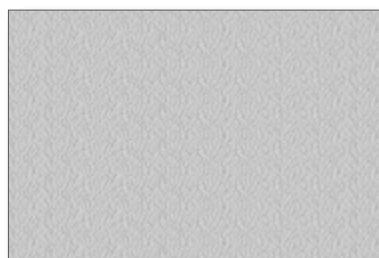

Polietilene Grigio chiaro Ral 7047
Light Grey Ral 7047 Polyethylene
codice/code: PLA04502

278
Polietilene
Polyethylene

PORTABLE ATELIER - Seduta sgabello/ <i>Stool seat</i>	PORTABLE ATELIER - Struttura sgabello/ <i>Stool Structure</i>	Codice materiale <i>Material code</i>
 <p data-bbox="234 526 465 598">Legno di Rovere <i>Oak wood</i> codice/code: LEIRO15401</p>	 <p data-bbox="939 526 1170 598">Faggio laccato nero <i>Black lacquered beech</i> codice/code: LEMLA09101</p>	<p data-bbox="1503 275 1727 355">374 Rovere-Faggio laccato <i>Oak-Beech lacque</i></p>
PORTABLE ATELIER - Accessori/ <i>Accessories</i>		
 <p data-bbox="74 1535 305 1607">Impiallacciato rovere <i>Oak veneered</i> codice/code: LEIRO15401</p>	<div style="display: flex; flex-wrap: wrap;"> <div style="width: 50%;">  <p data-bbox="802 1421 1124 1493">Acciaio verniciato Bianco Ral 9010 opaco <i>Matt White Ral 9010 painted Steel</i> codice/code: VER00206</p> </div> <div style="width: 50%;">  <p data-bbox="1152 1421 1474 1493">Acciaio verniciato Nero Ral 9005 opaco <i>Matt Black Ral 9005 painted Steel</i> codice/code: VER09103</p> </div> <div style="width: 50%;">  <p data-bbox="802 1688 1124 1760">Acciaio verniciato Giallo fluo escente <i>Fluorescent Yellow painted Steel</i> codice/code: VER02201</p> </div> <div style="width: 50%;">  <p data-bbox="1152 1688 1474 1760">Acciaio verniciato Arancione fluo <i>Fluorescent Orange painted Steel</i> codice/code: VER03401</p> </div> </div>	<p data-bbox="1503 1284 1727 1421">438 Impiallacciato rovere- Acciaio verniciato <i>Oak veneered- Painted steel</i></p>

ROLY POLY

Codice materiale
Material code



Polietilene Giallo Ral 1032
Yellow Ral 1032 Polyethylene
codice/code: PLA01901



Polietilene Rosso Ral 3016
Red Ral 3016 Polyethylene
codice/code: PLA03701



Polietilene Marrone Ral 8011
Brown Ral 8011 Polyethylene
codice/code: PLA08701

278
Polietilene
Polyethylene



Polietilene Nero Ral 9011
Black Ral 9011 Polyethylene
codice/code: PLA08801

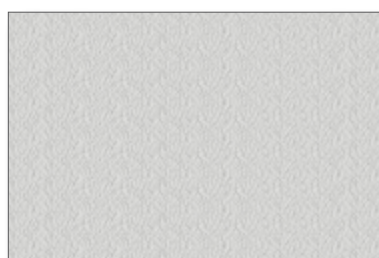

Polietilene Grigio chiaro Ral Design 000 85 00
Light Grey Ral Design 000 85 00 Polyethylene
codice/code: PLA08901



Polietilene Rosa Ral Design 030 70 20
Pink Ral Design 030 70 20 Polyethylene
codice/code: PLA02601

S.MARCO, S.MARCO LOUNGE - Struttura/
Structure

S.MARCO, S.MARCO LOUNGE - Tessuti-Pelli/
Fabrics-Leather



Faggio laccato nero
Black lacquered beech
codice/code: LEMLA09101

Per la scelta dei tessuti o pelli vedere tabella a pag.1129
For the choice of fabrics or leathers see table on page 1129

SERENO

Codice materiale
Material code

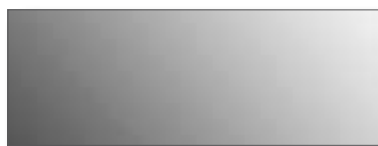

Acciaio inox lucidato
Polished stainless steel
codice/code: META95L1

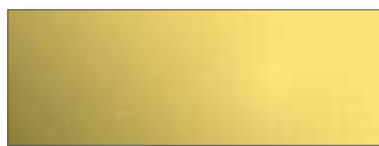

Alluminio metallizzato color Oro
Gold color metallized aluminum
codice/code: MET112L1

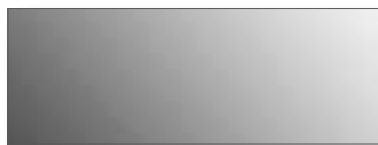

Acciaio inox lucidato
Polished stainless steel
codice/code: META95L1

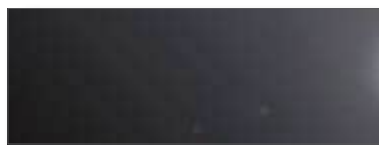

Alluminio metallizzato color Titanio
Titanium color metallized aluminum
codice/code: MET118L1

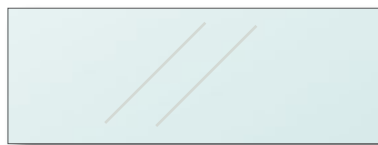

Vetro trasparente
Transparent glass



Alluminio metallizzato color Oro
Gold color metallized aluminum
codice/code: MET112L1

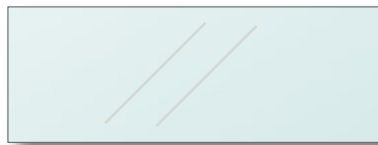

Vetro trasparente
Transparent glass

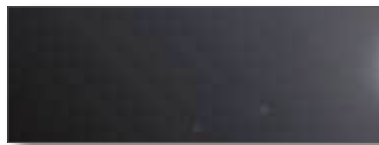

Alluminio metallizzato color Titanio
Titanium color metallized aluminum
codice/code: MET118L1

453
Acciaio inox lucidato-
Alluminio metallizzato
*Polished stainless steel-
Metallized Aluminum*

453
Acciaio inox lucidato-
Alluminio metallizzato
*Polished stainless steel-
Metallized Aluminum*

454
Vetro-
Alluminio metallizzato
*Glass-
Metallized Aluminum*

454
Vetro-
Alluminio metallizzato
*Glass-
Metallized Aluminum*



Polipropilene Bianco RAL 9001
White Ral 9001 Polypropylene
codice/code: PLA002O3



Polipropilene Rosa Pantone 7514C
Pink Pantone 7514C Polypropylene
codice/code: PLA024O1



Polipropilene Verde Pantone 7494C
Green Pantone 7494C Polypropylene
codice/code: PLA063O1

379
Polipropilene
Polypropylene



Polipropilene Rosso Pantone 1807C
Red Pantone 1807C Polypropylene
codice/code: PLA039O2



Polipropilene Grigio scuro Pantone 446U
Dark Grey Pantone 446U Polypropylene
codice/code: PLA050O1

SNIJDER BIRD/ TAYLOR BIRD

Codice materiale
Material code

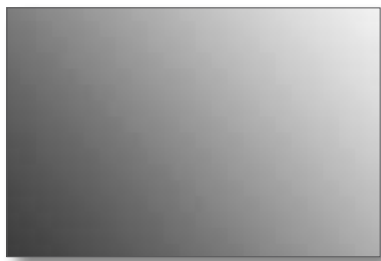

Acciaio inox lucido
Polished stainless Steel
codice/code: META95L1

431
Acciaio inox lucido
Polished stainless steel

TOKYO-POP

Codice materiale
Material code



Polietilene Bianco Ral 9016
White Ral 9016 Polyethylene
codice/code: PLA002O2



Polietilene Nero antracite Ral 7016
Anthracite Black Ral 7016 Polyethylene
codice/code: PLA091O5

278
Polietilene
Polyethylene

TOY

Codice materiale
Material code



Polipropilene Senape Dic C146
Mustard Dic C146 Polypropylene
codice/code: PLA02001



Polipropilene Cipria Dic C104
Carnation Dic C104 Polypropylene
codice/code: PLA01701



Polipropilene Bianco Ral 9016
White Ral 9016 Polypropylene
codice/code: PLA00202

379
Polipropilene
Polypropylene



Polipropilene Grigio ch. Pantone Warm Gray 4U
Light grey Pantone Warm gray 4U Polypropylene
codice/code: PLA04501

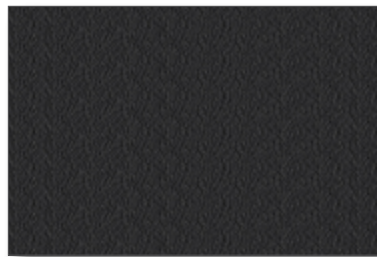

Polipropilene Nero Ral 9004
Black Ral 9004 Polypropylene
codice/code: PLA09103

VENUS

Codice materiale
Material code



Marmo ricomposto
Recomposed marble



Legno Rovere segato
Sawn oak wood
codice/code: LEIRO154S1

373
Marmo ricomposto-Rovere
Recomposed marble-Oak

VIGILIUS - Struttura/
Structure

VIGILIUS - Tessuti-Pelli/
Fabrics-Leather



Faggio laccato nero
Black lacquered beech
codice/code: LEMLA09101

Per la scelta dei tessuti o pelli vedere tabella a pag.1130
For the choice of fabrics or leathers see table on page 1130

WATERFALL

Codice materiale
Material code

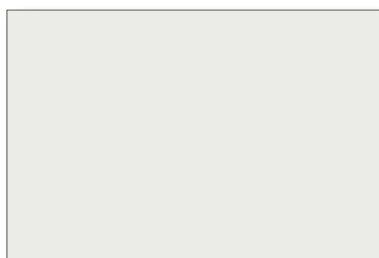

Poliuretano Bianco Ral 9003 lucido
Glossy White Ral 9003 Polyurethane
codice/code: VER002L4



Poliuretano Oro metallizzato Pantone 125C
Metallized Pantone Gold 125C Polyurethane
codice/code: VER112L1



Poliuretano Blu Pantone 296C
Blue Pantone 296C Polyurethane
codice/code: VER072L1

433
Poliuretano rigido verniciato
Painted rigid polyurethane

ZIGZAG - Libreria/
Bookshelf

Codice materiale
Material code

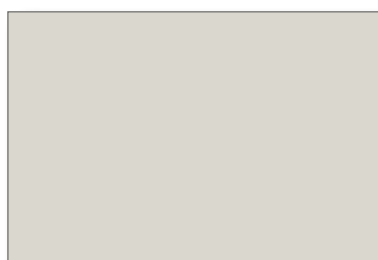

Acciaio verniciato Bianco
White painted Steel
codice/code: VER002L1



Acciaio verniciato Nero Ral 9005 opaco
Matt Black Ral 9005 painted Steel
codice/code: VER091O3

358
Acciaio verniciato
Painted steel

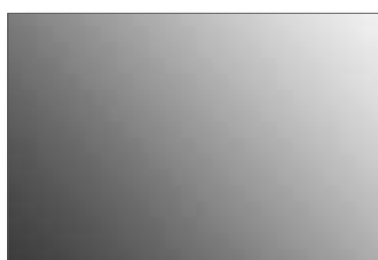

Acciaio inox lucidato a specchio
Mirror polished stainless steel
codice/code: META95L1

431
Acciaio inox lucidato
Polished stainless steel

ZIGZAG - Ripiani libreria/
Bookshelf shelves

ZIGZAG - Struttura libreria/
Bookshelf structure

Codice materiale
Material code



Impiallacciato Noce Canaletto
Canaletto Walnut veneer
codice/code: LEMNOF96O1



Acciaio verniciato Bronzo
Bronze painted Steel
codice/code: VER122L1

357
Impiallacciato noce-
Acciaio verniciato
*Walnut veneer-
Painted steel*



Impiallacciato Rovere
Oak veneer
codice/code: LEIRO154O1

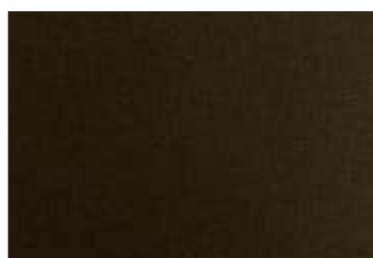

Acciaio verniciato Bronzo
Bronze painted Steel
codice/code: VER122L1

438
Impiallacciato rovere-
Acciaio verniciato
*Oak veneer-
Painted steel*

ZIGZAG - Reggilibri/
Bookends

Codice materiale
Material code

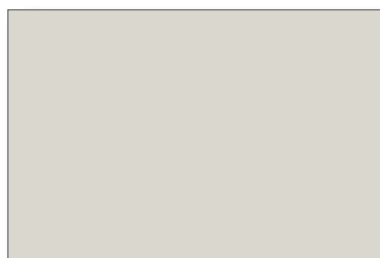

Acciaio verniciato Bianco
White painted Steel
codice/code: VER002L1



Acciaio verniciato Nero Ral 9005 opaco
Matt Black Ral 9005 painted Steel
codice/code: VER091O3



Acciaio verniciato Arancione flu
Orange fluorescent painted Steel
codice/code: VER034O1

358
Acciaio verniciato
Painted steel







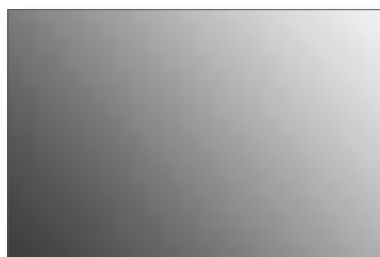



Acciaio verniciato Bronzo
Bronze painted Steel
codice/code: VER122L1

358
Acciaio verniciato
Painted steel

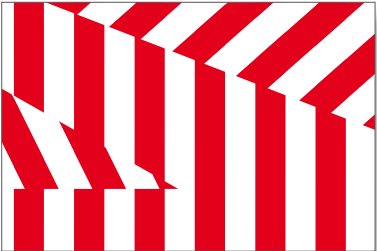

Acciaio inox lucidato a specchio
Mirror polished stainless steel
codice/code: META95L1

431
Acciaio inox lucidato
Polished stainless steel

ZIQQRAT -Struttura/ <i>Structure</i>	ZIQQRAT - Piedi/ <i>Feet</i>	Codice materiale <i>Material code</i>
 <p data-bbox="238 526 465 598"> Laminato Bianco/Nero <i>White/Black Laminate</i> codice/code: LARIG126O1 </p>	 <p data-bbox="939 526 1270 598"> MDF laccato Nero Ral 9005 lucido <i>Glossy Black Ral 9005 lacquered MDF</i> codice/code: VER091L4 </p>	<p data-bbox="1499 275 1749 355"> 121 Laminato-MDF laccato <i>Laminate-Lacquered MDF</i> </p>
 <p data-bbox="238 984 465 1057"> Laminato Bianco/Rosso <i>White/Red Laminate</i> codice/code: LARIG125O1 </p>	 <p data-bbox="939 984 1175 1057"> MDF laccato Rosso lucido <i>Glossy Red lacquered MDF</i> codice/code: VER039L6 </p>	<p data-bbox="1499 733 1749 814"> 121 Laminato-MDF laccato <i>Laminate-Lacquered MDF</i> </p>
 <p data-bbox="238 1443 484 1515"> Laminato Floreale <i>Floreal decoration Laminate</i> codice/code: LAFLO121O1 </p>	 <p data-bbox="939 1443 1175 1515"> MDF laccato Ottanio lucido <i>Glossy Teal lacquered MDF</i> codice/code: VERF58L1 </p>	<p data-bbox="1499 1192 1749 1273"> 121 Laminato-MDF laccato <i>Laminate-Lacquered MDF</i> </p>
 <p data-bbox="238 1902 484 1974"> Laminato Floreale <i>Floreal decoration Laminate</i> codice/code: LAFLO121O1 </p>	 <p data-bbox="939 1902 1257 1974"> Impiallacciato Noce Canaletto lucido <i>Glossy Canaletto Walnut veneer</i> codice/code: LEINOF96L1 </p>	<p data-bbox="1499 1624 1758 1705"> 122 Laminato-Impiallacciato noce <i>Laminate-Walnut veneer</i> </p>



Laminato Bianco/Nero
White/Black laminate
codice/code: LARIG12601

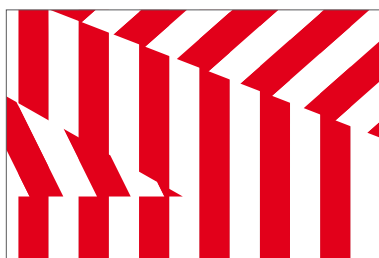

Laminato Bianco/Rosso
White/Red laminate
codice/code: LARIG12501













Laminato Floreale
Floreal decoration laminate
codice/code: LAFL012101

370
Laminato
Laminate

TESSUTI/PELLI

FABRICS/LEATHER

LEGENDA SIMBOLI/SYMBOL LEGEND

	Lavare a mano/ <i>Hand wash</i>
	Lavare max a 30 gradi/ <i>Water temperature 30° C or 80° F</i>
	Non lavare/ <i>Do not wash</i>
	Stirare max a 110 gradi/ <i>Maximum temperature 110° C or 230° F</i>
	Stirare max a 150 gradi/ <i>Maximum temperature 150° C or 300° F</i>
	Lavaggio con solventi clorati, percloroetilene ed essenze minerali, R133 ed R11 nel rispetto dei limiti di temperatura ed umidità/ <i>Washing with chlorinated solvents, perchloroethylene and mineral essences, R133 and R11 in accordance with temperature and humidity limits</i>
	Lavaggio con solventi clorati, percloroetilene ed essenze minerali, R133 ed R11/ <i>Washing with chlorinated solvents, perchloroethylene and mineral essences, R133 and R11</i>
	Stirare max a 150 gradi/ <i>Do not bleach</i>
	Candeggiabile/ <i>Bleachable</i>
	Non utilizzare l'asciugatrice/ <i>Do not tumble dry</i>

TESSUTI/FABRICS

CAT. A - BONIFACIO

Composizione/*Composition*: 100% CO Altezza/*Height*: 138/140 cm. Peso/*Weight*: 560gr. Abrasione/*Abrasion*: 20.000 Martindale (uso pubblico, uso regolare/*public use, regular use*).



CAT. A - MARSIGLIA

Composizione/*Composition*: 100% PL. Altezza/*Height*: 140 cm. Peso/*Weight*: 840gr. Abrasione/*Abrasion*: 80.000 Martindale (uso pubblico, uso molto intensivo/*public use, very intensive use*). Idrorepellente, irrestingibile/*Water repellent, unbreakable*.



CAT. A - PETRA

Composizione/*Composition*: 50% CO riciclato/*recycled CO*, 35% PL, 15% PC. Altezza/*Height*: 140 cm. Peso/*Weight*: 490gr. Abrasione/*Abrasion*: 20.000 Martindale (uso pubblico, uso regolare/*public use, regular use*). Antigoccia, idrorepellente/*Anti-drip, water repellent*.



CAT. A - DAMASCO

Composizione/*Composition*: 50% CO riciclato/*recycled CO*, 35% PL, 15% PC. Altezza/*Height*: 140 cm. Peso/*Weight*: 590gr. Abrasione/*Abrasion*: 24.000 Martindale (uso pubblico, uso regolare/*public use, regular use*). Antigoccia, idrorepellente/*Anti-drip, water repellent*.



CAT. A - COLORADO

Composizione/*Composition*: 68% PVC, 30% CO, 2% PU. Altezza/*Height*: 140 cm. Peso/*Weight*: 460 gr/mq. Abrasione/*Abrasion*: 100.000 Martindale (uso pubblico, uso molto intensivo/*public use, very intensive use*). Spessore/*Thickness* 1.0/1.1 mm

Pulire solo con panno umido e detergente neutro/*Clean only with a damp cloth and a neutral detergent*.

CAT. B - BERLINO

Composizione/*Composition*: 68% PL, 20% CO, 12% LI. Altezza/*Height*: 140 cm. Peso/*Weight*: 670gr. Abrasione/*Abrasion*: 65.000 Martindale (uso pubblico, uso molto intensivo/*public use, very intensive use*). BS5852, Antigoccia, idrorepellente/*Anti-drip, water repellent*.



CAT. B - JAKARTA

Composizione/*Composition*: 100% PL riciclato biodegradabile/*PL recycled biodegradable*. Altezza/*Height*: 140 cm. Peso/*Weight*: 800gr. Abrasione/*Abrasion*: 100.000 Martindale (uso



CAT. B - GINEVRA

Composizione/*Composition*: 100% PL. Altezza/*Height*: 140 cm. Peso/*Weight*: 460gr. Abrasione/*Abrasion*: 25.000 Martindale (uso pubblico, uso regolare/*public use, regular use*).



TESSUTI/FABRICS

CAT.B - CIPRO

Composizione/*Composition*: 100% PC. Altezza/*Height*: 140 cm. Peso/*Weight*: 270gr. Abrasione/*Abrasion*: 17.000 Martindale (uso personale, uso regolare/*personal use, regular use*).



CAT.B - PANTELLERIA

Composizione/*Composition*: 100% RECPP. Altezza/*Height*: 138 cm. Peso/*Weight*: 460gr. Abrasione/*Abrasion*: 50.000 Martindale (uso pubblico, uso molto intensivo/*public use, very intensive use*). BS5852source 0,EN1021-1,CAL117/BS5852source 0,EN1021-1



CAT.C - LOIRA

Composizione/*Composition*: 100% Velluto di cotone/*Cotton velvet*. Altezza/*Height*: 140 cm. Peso/*Weight*: 630gr. Abrasione/*Abrasion*: 100.000 Martindale (uso pubblico, uso molto intensivo/*public use, very intensive use*). CALTB117, BS5852 part 1 schedule 4 source 0



CAT.C - LISBONA

Composizione/*Composition*: 72% LI, 14% CO, 14% VI. Altezza/*Height*: 140 cm. Peso/*Weight*: 735gr. Abrasione/*Abrasion*: 25.000 Martindale (uso pubblico, uso regolare/*public use, regular use*).



CAT.C - AMBURGO

Composizione/*Composition*: 100% PP. Altezza/*Height*: 140 cm. Peso/*Weight*: 1050 gr. Abrasione/*Abrasion*: 40.000 Martindale (uso pubblico, uso molto intensivo/*public use, very intensive use*). CAL117, BS5852 Cigaret test



CAT.C - BERNA

Composizione/*Composition*: 29% PL, 29% PC, 21% CO, 15% WO, 6% VI. Altezza/*Height*: 140 cm. Peso/*Weight*: 820gr. Abrasione/*Abrasion*: 40.000 Martindale (uso pubblico, uso molto intensivo/*public use, very intensive use*). CAL117, BS5852 Cigaret test



CAT.C - BARCELLONA

Composizione/*Composition*: 100% LI. Altezza/*Height*: 138/140 cm. Peso/*Weight*: 680gr. Abrasione/*Abrasion*: 30.000 Martindale (uso pubblico, uso intensivo/*public use, intensive use*).



CAT.C - MOSCA

Composizione/*Composition*: 100% PL Altezza/*Height*: 145 cm. Peso/*Weight*: 950gr.



TESSUTI/FABRICS

CAT. D - MALMÖ

Composizione/*Composition*: 32% CO, 61% VW, 7% PA. Altezza/*Height*: 140 cm. Peso/*Weight*: 1200gr. Abrasione/*Abrasion*: 25.000 Martindale (uso pubblico, uso regolare/public use, regular use).



CAT. E - DIVINA (KVADRAT)

Composizione/*Composition*: 100% VW. Altezza/*Height*: 150 cm. Peso/*Weight*: 840gr. Abrasione/*Abrasion*: 45.000 Martindale (uso pubblico, uso molto intensivo/public use, very intensive use), CAL117, crib51MOFTP,UNI9175 11M



CAT. E - VENEZIA

Composizione/*Composition*: 100% CO. Altezza/*Height*: 140 cm. Peso/*Weight*: 1200gr. Abrasione/*Abrasion*: 50.000 Martindale, CAL TB117 (uso pubblico, uso molto intensivo/public use, very intensive use).



CAT. E - PECHINO

Composizione/*Composition*: 85% MA, 15% PL. Altezza/*Height*: 145 cm. Peso/*Weight*: 1000gr.



CAT. E - MONGOLIA

Composizione/*Composition*: 82% MA, 18% PL. Altezza/*Height*: 145 cm. Peso/*Weight*: 950gr.



PELLI/LEATHERS

CAT. P - NIAGARA

Pelle bovina ai sali di cromo. Pigmentata - Fiore Corretto - Tintura all'anilina passante in botte. Spessore 1.4 - 1.6 mm

Test di infiammabilità: EN 1021-1 EN 1021-2, BS 5852 Source 0, BS 5852 Source 1, Cal TB117, NFPA 260/UFAC*

* Test eseguiti periodicamente sui campioni di pellame secondo il piano di audit annuale. Il processo di produzione standard garantisce la conformità al requisito.

Pulizia e manutenzione:

Evitare la luce diretta del sole. Evitare l'esposizione a fonti di calore. Spolverare regolarmente la pelle con un panno morbido ed asciutto. Eventuali macchie si possono eliminare usando un panno inumidito con acqua e sapone neutro. Asciugare immediatamente dopo il trattamento. Non strofinare e ma tamponare delicatamente dai bordi al centro della macchia.

Chrome tanned bovine raw hides. Pigmented - Corrected Grain - Aniline through dyed. Thickness 1.4 - 1.6 mm

*Fammability tests: EN 1021-1, EN 1021-2, BS 5852 Source 0, BS 5852 Source 1, Cal TB117, NFPA 260/UFAC**

** Tests are performed periodically on the leather samples in accordance with the annual audit plan. The standardized production process ensures compliance with the requirement.*

Cleaning and maintenance:

Avoid placing leather in direct sun. Keep the leather away from direct heat. Dust regularly with a soft and dry cloth. Spots can be cleaned with a lightly damp cloth and mild soap. Dry immediately after the treatment. Do not rub. Use a light circular motion working toward the center of the stain.

CAT. O - RIO

Pelle bovina a mezzo fio e a grana naturale. Concia al cromo. Tintura passante; rifinizione con resine e pigmenti. Articolo con mano morbida, tatto ceroso e aspetto semiopaco. Spessore finito 0.9 - 1.1 mm

Test di infiammabilità: BS 55852:1979 BS EN 1021-1-2-2006

Pulizia e manutenzione:

Evitare la luce diretta del sole. Evitare l'esposizione a fonti di calore. Spolverare regolarmente la pelle con un panno morbido ed asciutto. Eventuali macchie si possono eliminare usando un panno inumidito con acqua e sapone neutro. Asciugare immediatamente dopo il trattamento. Non strofinare e ma tamponare delicatamente dai bordi al centro della macchia.

Bovine of European origin, lightly buffed natural grain. Through dyed; finishing with resins and pigments. Article with a pigmented and protective coat, with a soft, waxy feel and semi-matt appearance. Finished thickness 0.9 - 1.1 mm

Fammability tests: BS 55852:1979, BS EN 1021-1-2-2006

Cleaning and maintenance:

Avoid placing leather in direct sun. Keep the leather away from direct heat. Dust regularly with a soft and dry cloth. Spots can be cleaned with a lightly damp cloth and mild soap. Dry immediately after the treatment. Do not rub. Use a light circular motion working toward the center of the stain.

PELLI/LEATHER

CAT. ZC - CHURCHILL

Pelle bovina ai sali di cromo. Anilina - Pieno fio e - Tintura all'anilina passante in botte. Spessore 1.0 - 1.2 mm
Test di infiammabilità: EN 1021-1 EN 1021-2, BS 5852 Source 0, BS 5852 Source 1, Cal TB117, NFPA 260/UFAC*

* Test eseguiti periodicamente sui campioni di pellame secondo il piano di audit annuale. Il processo di produzione standard garantisce la conformità al requisito.

Pulizia e manutenzione:

Evitare la luce diretta del sole. Evitare l'esposizione a fonti di calore. Spolverare regolarmente la pelle con un panno morbido ed asciutto. Eventuali macchie si possono eliminare usando un panno inumidito con acqua e sapone neutro. Asciugare immediatamente dopo il trattamento. Non strofinare e ma tamponare delicatamente dai bordi al centro della macchia.

Chrome tanned bovine raw hides. Aniline - Full Grain - Through dyeing aniline. Thickness 1.0 - 1.2 mm

*Test di infiammabilità: EN 1021-1, EN 1021-2, BS 5852 Source 0, BS 5852 Source 1, Cal TB117, NFPA 260/UFAC**

** Tests are performed periodically on the leather samples in accordance with the annual audit plan. The standardized production process ensures compliance with the requirement.*

Cleaning and maintenance:

Avoid placing leather in direct sun. Keep the leather away from direct heat. Dust regularly with a soft and dry cloth. Spots can be cleaned with a lightly damp cloth and mild soap. Dry immediately after the treatment. Do not rub. Use a light circular motion working toward the center of the stain.

CAT. ZME - AMUR

Pelle bovina di provenienza europea, ad effetto invecchiato. Questo articolo di alta qualità è ottenuto partendo da una pelle nubuck, che viene leggermente ugualizzato con anilina, ed abrasivato a mano per dare un effetto invecchiato. La mano è molto calda e setosa. Spessore 0.9 - 1.1 mm
Test di infiammabilità: BS 5852:1979 BS EN 1021-1-2-2006

Pulizia e manutenzione:

Evitare la luce diretta del sole. Evitare l'esposizione a fonti di calore. Spolverare regolarmente la pelle con un panno morbido ed asciutto. Eventuali macchie si possono eliminare usando un panno inumidito con acqua e sapone neutro. Asciugare immediatamente dopo il trattamento. Non strofinare e ma tamponare delicatamente dai bordi al centro della macchia.

Bovine of European origin, lightly buffed natural grain. Through dyed; finishing with resins and pigments. Article with a pigmented and protective coat, with a soft, waxy feel and semi-matt appearance. Finished thickness 0.9 - 1.1 mm

Flammability tests: BS 5852:1979, BS EN 1021-1-2-2006

Cleaning and maintenance:

Avoid placing leather in direct sun. Keep the leather away from direct heat. Dust regularly with a soft and dry cloth. Spots can be cleaned with a lightly damp cloth and mild soap. Dry immediately after the treatment. Do not rub. Use a light circular motion working toward the center of the stain.

PELLI/LEATHER

CAT. ZS - SACRAMENTO

Pelle bovina 100% di origine europea - Anilina pieno fio e. Spessore 1.4 - 1.6 mm
I colori sono sensibili all'esposizione ai raggi UV.

Pulizia e manutenzione:

Evitare la luce diretta del sole. Evitare l'esposizione a fonti di calore. Spolverare regolarmente la pelle con un panno morbido ed asciutto. Eventuali macchie si possono eliminare usando un panno inumidito con acqua e sapone neutro. Asciugare immediatamente dopo il trattamento. Non strofinare e ma tamponare delicatamente dai bordi al centro della macchia.

*Cow skins, 100% european origin. Aniline full grain. Thickness 1.4 - 1.6 mm
The colors are sensitive to exposure to UV.*

Cleaning and maintenance:

Avoid placing leather in direct sun. Keep the leather away from direct heat. Dust regularly with a soft and dry cloth. Spots can be cleaned with a lightly damp cloth and mild soap. Dry immediately after the treatment. Do not rub. Use a light circular motion working toward the center of the stain.

CAT. ZA - PURUS

Pelle bovina di provenienza europea. Concia al cromo - Tintura all'anilina. - Semi anilina - Pieno fio e. Spessore 1.0 - 1.2 mm
Test di infiammabilità: BS 5852 1-2 EN 1021 1-2, TB 117-2013

Pulizia e manutenzione:

Evitare la luce diretta del sole. Evitare l'esposizione a fonti di calore. Spolverare regolarmente la pelle con un panno morbido ed asciutto. Eventuali macchie si possono eliminare usando un panno inumidito con acqua e sapone neutro. Asciugare immediatamente dopo il trattamento. Non strofinare e ma tamponare delicatamente dai bordi al centro della macchia.

*Bovine of European origin. Chrome tanning - Aniline dyed - Semi aniline - Full grain. Thickness 1.0 - 1.2 mm
Flammability tests: BS 5852 1-2, EN 1021 1-2, TB 117-2013*

Cleaning and maintenance:

Avoid placing leather in direct sun. Keep the leather away from direct heat. Dust regularly with a soft and dry cloth. Spots can be cleaned with a lightly damp cloth and mild soap. Dry immediately after the treatment. Do not rub. Use a light circular motion working toward the center of the stain.

CONDIZIONI GENERALI DI VENDITA
GENERAL TERMS OF SALES

Condizioni generali di vendita

Assunzione del contratto

Ogni ordine viene accettato ed ogni fornitura viene eseguita alle condizioni generali di vendita sotto indicate, a meno che le deroghe siano state confermate per iscritto da Driade.

Prezzi

Nel presente listino i prezzi di vendita sono espressi in €. Nei prezzi di vendita non sono compresi gli oneri relativi alla progettazione, consegna e montaggio. In presenza di prodotti imballati in confezioni da più pezzi, è data facoltà di acquistare un singolo articolo con un prezzo di listino maggiorato di € 50 netto cad. La consegna dei Prodotti è effettuata presso il Luogo di Consegna alle condizioni riportate di seguito:

- Franco destino per ordini di valore imponibile superiore a € 999
- Addebito in fattura dell' 8% sul valore imponibile per ordini da € 501 a € 999
- Addebito in fattura di € 75 per ordini di valore imponibile fino a € 50

Le condizioni sopracitate sono valide per i seguenti paesi:

Italia, Francia, Spagna (escluse isole), Austria, Svizzera, Germania, Belgio, Lussemburgo, Paesi Bassi e Slovenia.

Per gli altri paesi consultare il Customer Service.

Per ordini superiori ai minimi indicati i prezzi sono comprensivi delle spese di imballo standard e di trasporto solo dove previsto. Per imballi speciali a richiesta del cliente sarà applicato un sovrapprezzo da concordare.

Termini di consegna

I termini di consegna esposti nelle conferme d'ordine sono puramente indicativi, non sono vincolanti e si riferiscono alla data di consegna allo spedizioniiere o al vettore.

Eventuali termini di consegna tassativi devono essere sempre evidenziati e confermati per iscritto.

I ritardi di consegna non daranno in alcun caso il diritto ad annullamento o riduzioni del contratto, né ad indennizzi di nessuna specie.

La ditta si riserva la possibilità di effettuare consegne parziali.

Consegne e trasporti

La consegna si intende valida ad ogni effetto anche se effettuata a mezzo spedizioniiere o vettore. La merce viaggia a rischio e pericolo del committente. Spetta al committente provvedere allo scarico, verifica e il numero dei colli e lo stato dell'imballaggio e fare le eventuali riserve al vettore o allo spedizioniiere. In caso di danno presunto la consegna è da assumere con riserva e va comunicata per iscritto entro sette giorni all'azienda. Nei casi che, dietro istruzione dell'acquirente, la merce venga consegnata direttamente a terzi, l'acquirente stesso rimane impegnato nei confronti del venditore a tutti gli effetti legali come se fosse lui il destinatario.

Tolleranze

I colori di campionario per stoffe, per laccature e per tutti i materiali impiegati sono soltanto indicativi, non essendo possibile tecnicamente assicurare la costanza di tinta a distanza di tempo. Il committente conferendo ordini, accetta tali tolleranze di colore.

Reclami

I reclami, di qualunque genere essi siano, dovranno essere fatti per iscritto. Obbligatoriamente entro sette giorni dal ricevimento della merce se relativi a danni di trasporto.

Annullamenti

Il compratore con la trasmissione dell'ordine resta impegnato verso il venditore, ma i contratti si intendono perfezionati e vincolanti per il venditore stesso solo in seguito a sua conferma scritta.

Se la conferma d'ordine non è contestata entro una settimana, si intende esplicitamente accettata. Trascorso tale termine, non si accettano annullamenti o modifiche di ordini già trasmessi.

Resi

Non si accettano resi di merce se non espressamente autorizzati per iscritto. Ogni reso avviene a rischio dell'acquirente.

Pagamenti

I pagamenti devono essere eseguiti secondo i termini indicati nella conferma d'ordine. La ditta si riserva il diritto di sospendere le consegne, in qualunque caso di inadempimento, anche parziale dell'acquirente agli obblighi assunti. I pagamenti devono essere effettuati al domicilio Driade, alle scadenze stabilite e per l'importo

pattuito. Il ritardo del pagamento, anche parziale, delle fatture oltre la loro scadenza dà luogo all'immediata decorrenza degli interessi al tasso ufficiale di sconto maggiorato di 4 punti. Il mancato pagamento a qualsiasi titolo autorizza Driade a sospendere ulteriori forniture. Per i pagamenti contro tratta o ricevuta bancaria, le spese di incasso e bollo si intendono a carico dell'acquirente.

Ritardo ritiro merce accettata

Nei casi in cui l'acquirente si rifiuti di accettare la merce in consegna o di ritirarla dalla fabbrica nei termini stabiliti, la merce fatturata rimane a disposizione dell'acquirente, che deve provvedere al pagamento nei termini indicati nella conferma d'ordine.

Riservato dominio

La merce fornita resta di proprietà del venditore fino al pagamento integrale delle relative fatture.

Validità del listino

Il presente listino annulla ogni precedente quotazione, non costituisce offerta e può essere variato senza preavviso.

Diritti

Tutti i diritti inerenti ai progetti e ai prodotti sono riservati. È pertanto vietato l'utilizzo dei marchi, dei nomi e dell'immagine dei prodotti e dei relativi listini prezzi e cataloghi, senza espressa autorizzazione scritta da parte della ditta.

Garanzia

Driade garantisce tutti i suoi prodotti presenti nei cataloghi per due (2) anni dalla data di fatturazione. La Garanzia Europea (Direttiva Europea 1999/44/CE) assicura tutti i clienti contro i difetti originali di produzione delle parti strutturali. Tale Garanzia include la sostituzione gratuita dei prodotti non utilizzabili o difettosi verificati e riconosciuti dal Controllo Qualità di Driade. La Garanzia non riconosce i danni causati dalla normale usura del prodotto, dall'utilizzo o trattamento inadeguato, incidenti o cause di forza maggiore. La Garanzia non sarà valida se i prodotti sono stati smontati, modificati o riparati da chiunque eccetto Driade. Qualsiasi riparazione effettuata e autorizzata da Driade, durante il periodo di Garanzia, non interrompe la validità della medesima. Pertanto, la Garanzia scadrà regolarmente dopo 2 anni dalla data della fattura.

Foro competente

Il foro competente per qualsiasi controversia è esclusivamente quello di Milano, senza possibilità di alcuna modificazione. I contratti, anche se stipulati con acquirenti stranieri e per materiali forniti all'estero, sono regolati dalla legislazione italiana.

Imbottiti

Calcolo del prezzo

I prezzi si riferiscono agli elementi rivestiti con un tessuto in variante unica. Nel caso di scelta di tessuti in più varianti nell'ambito della stessa categoria, oppure di categorie diverse, il prezzo da considerarsi per tutto il rivestimento è quello della categoria superiore tra quelle utilizzate.

Lavaggio

La gran parte dei rivestimenti utilizzati dal venditore è sfoderabile e lavabile.

Nonostante la massima attenzione prestata nella scelta delle stoffe, queste possono restringersi e variare di colore, se non sono lavate in modo appropriato.

Cuoio pelli e marmi

Segni ed imperfezioni del cuoio, della pelle e dei marmi non sono difetti, ma caratteristiche che ne attestano l'autenticità.

Altro

Cartelle campioni, foto, illustrazioni, schizzi etc. restano di proprietà del venditore e possono in ogni momento essere richieste in restituzione. Se uno o più punti di queste condizioni di vendita dovessero risultare non validi, ciò non va comunque ad intaccare la validità delle rimanenti clausole.

Articoli Outdoor in plastica

I mobili in polietilene ad alta densità non richiedono molta manutenzione e, nella maggior parte dei casi, non è necessario più di un leggero strofinamento per mantenerli come nuovi. Tuttavia, trattandosi di mobili da esterno, accumuleranno sporco, fango, cibo e polvere che lasciati sulla superficie possono trasformarsi in muffe o funghi: durante l'estate può formarsi se costantemente esposto alla luce solare diretta. Quando non in uso, dovrebbe essere tenuto in un'area ombreggiata quando possibile. I mobili da esterno di Driade possono sopportare la luce solare, ma è comunque importante cercare di mantenerli ombreggiati ogni volta che è possibile.

NB:

L'azienda è disponibile a fornire i soli rivestimenti, con termini e condizioni da definire in funzione delle commesse.

Le dimensioni (espresse in cm) e i prezzi si riferiscono al singolo articolo.

I pesi e i volumi si riferiscono alle confezioni.

La ditta si riserva il diritto di apportare modifiche di disegno e di materiali ai propri prodotti senza obbligo di preavviso.

I riferimenti RAL, PANTONE o DIC inseriti all'interno del listino, sono indicativi.

Il legno è un materiale unico in natura non replicabile e pertanto le immagini sono puramente indicative e potrebbero non rispecchiare appieno le caratteristiche estetiche delle finiture reali.

General terms of sale

Assumption

Every order is considered accepted and every delivery is made respecting the general terms set out below, unless any exception is officially confirmed in writing by Driade.

Prices

Prices are quoted in €.

Prices are not inclusive of charges related to the design, assembly or installation.

In case of products packed in several pieces, it is possible to purchase single items with a net surcharge of €50 each.

Products are shipped DAP under the following conditions:

- Free of charge for orders with a taxable value exceeding € 999
- Freight charge of 8% add to Invoice on the taxable value for orders from €501 to €999
- Freight charge of €75 add to Invoice for orders of taxable value up to €500

The above conditions are valid for the following countries:

Italy, France, Spain (excluding islands), Austria, Switzerland, Germany, Belgium, Luxembourg, the Netherlands, and Slovenia.

Please, refer to Driade Customer Service for all other countries. For orders above the minimum indicated prices are inclusive of standard packaging and transport costs only where provided. For special packaging at the request of the customer will be charged a surcharge to be agreed.

Order lead time

The lead time set forth in the order confirmations are only indicative, non-binding and refer to the date of goods collection at Driade warehouse by the freight forwarder. Any imperative deadline must always be communicated in writing by the customer and confirmed in writing by Driade.

Delays in delivery, in any case, will not give right to cancellation or reduction of the contract, or indemnities of any kind. The company reserves the right to make partial deliveries.

Deliveries and Transport

The Products shall be delivered in accordance with the procedures and in the places specified in the confirmed order. Unless otherwise agreed between the parties, the products will be delivered to the place of delivery in accordance with the following Incoterms:

- Delivery Duty Paid (DDP) in case of deliveries within Europe, Switzerland and UK territories. Driade shall pay the delivery from its factory to the place of delivery, export and import customs clearance and duties. Any other charges and/or other fees such as VAT are excluded and shall be paid by the customer. Upon goods receipt, the customer shall download them at its own risks and expenses.
- Ex-works (EXW) in case of deliveries outside Europe, Switzerland and UK territories. The customer shall pay any and all freight cost from Driade's factory to its own warehouse, export and import customs clearance, taxes, duties, and any other charges and/or other fees. It is Driade's responsibility for packing and loading the goods only. Therefore, it is necessary that the client always advise the means of transport. Once goods leave Driade warehouse, the risk falls on the customer.

Upon the goods collection (in case of EXW) and upon the goods receipt (in case of DDP), the customer shall verify the number of parcels and that the packaging is undamaged.

The customer shall always accept the goods delivery by signing conditionally the delivery note of the freight forwarder. In case of alleged damage, the customer shall add any eventual comment on the delivery note and shall notify Driade within seven (7) days.

If, as requested by the buyer, the goods are delivered directly to a third party, the buyer remains committed himself against the seller for all legal effects as if he were the recipient.

Tolerances

The colors of fabrics, lacquers and all materials used are only indicative, since it is technically impossible to ensure the consistency of color after some time. The buyer implicitly accepts these color tolerances.

Claims

The claims, of whatever kind must be made in writing within the terms below:

- Deliveries within the European Territory, including Switzerland and UK: within 7 days from the receipt of the products (as resulting from the relevant packing slip and delivery note);
- Deliveries outside the European Territory: within 2 months from the date of collection of the products at Driade's warehouse (as resulting from the relevant invoice).

Claims regarding any defective products shall be provided upon presentation of requested documents such as invoice and photos.

Cancellations

The buyer with the transmission of the order remains committed to the seller, but the contracts are finalized and binding on the seller himself only after his written confirmation. If the order confirmation is not contested by the customer within a week, it has to be intended explicitly accepted. After that time, Driade does not accept cancellations or changes to orders that have already been registered.

Refunds

title, will authorize Driade to suspend further deliveries. For payments against draft or bank receipt, collection charges and stamp duty are intended at purchaser's expense. Ownership of the products shall not pass to the customer until Driade has received payment in full of any amount due to by the retailer to the Driade for the Products.

Delay on collection of confirmed and accepted goods

If the buyer refuses to accept the delivery of the goods or to collect them from the factory within the prescribed period, goods will be invoiced and will remain available for the customer but he must arrange the payment in the terms specified in the order confirmation

Lien

The goods supplied remain a property of the seller until the complete payment of the related invoices.

Validity of the price list

This price list cancels all previous quotation, do not constitute an offer and may be changed without prior notice.

Rights

All rights related to projects and products are reserved. The use of trademarks, names and picture of the products, price lists and catalogs, without express written permission from the Company, is strictly forbidden.

Warranty

Driade cover all its Products in current catalogue with 2 (two) years of Warranty from the invoice date. This European Warranty (Dir. EU 1999/44/CE) ensures all our Clients against original defects in workmanship of the structural parts. The Warranty includes the free replacement of unusable or defective items verified and recognized by Driade Quality control. The Warranty does not cover damages caused by normal wear and tear, inadequate treatment or use, accident or force majeure. The Warranty will no longer be valid if the products are disassembled, modified or repaired by anyone except Driade. Any repairs made or authorized by Driade, under warranty, will not interrupt the warranty period. Therefore, the Warranty will still expire after two years from the date of the invoice.

Jurisdiction

The place of jurisdiction for any dispute shall be exclusively that of Milan, without the possibility of any modification. The contracts, even if entered into with foreign buyers and for materials supplied abroad, are governed by Italian law.

Upholstered items

Price calculation

The prices refer to covers in a fabric variant only. In case of more than one variant of fabric within the same category or among different categories, the price for the whole cover will be the highest one.

Wash

The most part of covers is removable and washable. Despite the utmost care taken in the choice of fabrics, these may shrink and change color if they are not washed properly.

Leather and marble

Signs and imperfections in leather and marble are not defects but features that attest its authenticity.

Tools

Samples folders, photos, illustrations, sketches etc. remain an exclusive property of the seller which at any time may requests to be returned. If ever one or more points of these sale terms will become invalid, this shall not affect the validity of the remaining provisions.

Plastic Outdoor Items

High-density polyethylene furniture doesn't require a lot of maintenance and in most cases, it won't need more than a gentle scrub to keep it looking like new. However, since it is outdoor furniture, it will still accumulate dirt, mud, food and dust that left on its surface can turn into mold or mildew. During summer it can become weaker or misshapen if constantly in direct sunlight. When not in use, it should be kept in a shaded area whenever possible. The stackability of plastic furniture makes this easy to achieve. Driade's outdoor furniture may have some sun protection, but it's still important to try to keep it shaded whenever possible.

Note:

The company is also available to supply the upholstery covers only, with terms and conditions to be defined according to orders.

The size (in cm) and the prices are for single item. The weights and volumes refer to the packed items. The company reserves the right to make changes in design and materials of its products without prior notice. RAL, PANTONE, DIC and colors references in the price list are purely indicative

Wood is a unique material in nature that cannot be replicated and therefore the images are purely indicative and may not fully reflect the aesthetic characteristics of the real finishes.

driade

HEADQUARTER

DRIADE S.R.L.

A brand of ItalianCreationGroup

Alzaia Trieste 49

I-20094 Corsico (Mi)

Ph. +39 0523 818618

Fax +39 0523 822360

info@driade.com

P.I. / C.F.: 09712410969

ICGROUP US CORP

152 Madison Ave, Suite # 1002

New York, NY 10016, USA

Ph. +1 (212) 334 3295

Stampa/*Print*: Luglio/*July* 2023



Premio/*Award*
ADI Compasso d'Oro
Delfina Immagine coordinata, Legato, MT3

driade.com